

ASUS[®]

PA279 Series LCD Monitor

User Guide

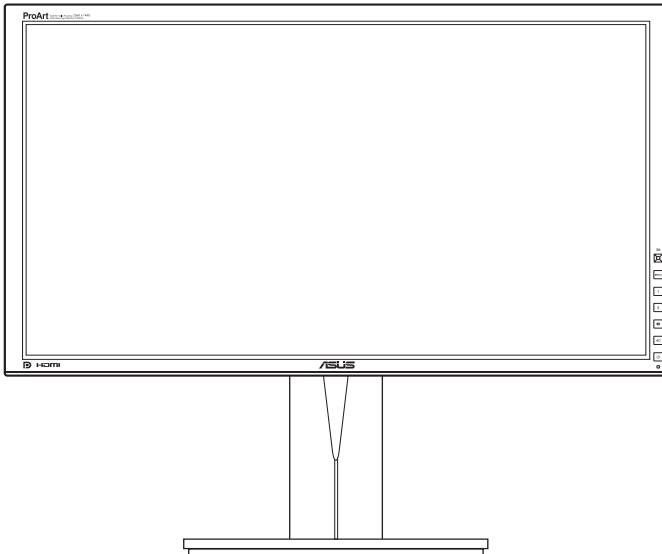

Contents

Contents	ii
Notices.....	iii
Safety information	iv
Care & Cleaning.....	v
Chapter 1: Product introduction	
1.1 Welcome!	1-1
1.2 Package contents.....	1-1
1.3 Monitor introduction	1-2
1.3.1 Front view	1-2
1.3.2 Back view.....	1-3
1.3.3 QuickFit Function	1-5
Chapter 2: Setup	
2.1 Detaching the arm/base (for VESA wall mount).....	2-1
2.2 Adjusting the monitor.....	2-2
2.3 Connecting the cables.....	2-3
2.4 Turning on the monitor.....	2-3
Chapter 3: General instructions	
3.1 OSD (On-Screen Display) menu	3-1
3.1.1 How to reconfigure.....	3-1
3.1.2 OSD function introduction	3-1
3.2 Specifications summary.....	3-8
3.3 Troubleshooting (FAQ).....	3-9
3.4 Supported operating modes	3-10

Notices

Federal Communications Commission Statement

This device complies with Part 15 of the FCC Rules. Operation is subject to the following two conditions:

- This device may not cause harmful interference, and
- This device must accept any interference received including interference that may cause undesired operation.

This equipment has been tested and found to comply with the limits for a Class B digital device, pursuant to Part 15 of the FCC Rules. These limits are designed to provide reasonable protection against harmful interference in a residential installation. This equipment generates, uses and can radiate radio frequency energy and, if not installed and used in accordance with manufacturer's instructions, may cause harmful interference to radio communications. However, there is no guarantee that interference will not occur in a particular installation. If this equipment does cause harmful interference to radio or television reception, which can be determined by turning the equipment off and on, the user is encouraged to try to correct the interference by one or more of the following measures:

- Reorient or relocate the receiving antenna.
- Increase the separation between the equipment and receiver.
- Connect the equipment to an outlet on a circuit different from that to which the receiver is connected.
- Consult the dealer or an experienced radio/TV technician for help.



The use of shielded cables for connection of the monitor to the graphics card is required to assure compliance with FCC regulations. Changes or modifications to this unit not expressly approved by the party responsible for compliance could void the user's authority to operate this equipment.



As an Energy Star® Partner, our company has determined that this product meets the Energy Star® guidelines for energy efficiency.

Canadian Department of Communications Statement

This digital apparatus does not exceed the Class B limits for radio noise emissions from digital apparatus set out in the Radio Interference Regulations of the Canadian Department of Communications.

This class B digital apparatus complies with Canadian ICES-003.

This Class B digital apparatus meets all requirements of the Canadian Interference - Causing Equipment Regulations.

Cet appareil numérique de la classe B respecte toutes les exigences du Règlement sur le matériel brouiller du Canada.

Safety information

- Before setting up the monitor, carefully read all the documentation that came with the package.
- To prevent fire or shock hazard, never expose the monitor to rain or moisture.
- Never try to open the monitor cabinet. The dangerous high voltages inside the monitor may result in serious physical injury.
- If the power supply is broken, do not try to fix it by yourself. Contact a qualified service technician or your retailer.
- Before using the product, make sure all cables are correctly connected and the power cables are not damaged. If you detect any damage, contact your dealer immediately.
- Slots and openings on the back or top of the cabinet are provided for ventilation. Do not block these slots. Never place this product near or over a radiator or heat source unless proper ventilation is provided.
- The monitor should be operated only from the type of power source indicated on the label. If you are not sure of the type of power supply to your home, consult your dealer or local power company.
- Use the appropriate power plug which complies with your local power standard.
- Do not overload power strips and extension cords. Overloading can result in fire or electric shock.
- Avoid dust, humidity, and temperature extremes. Do not place the monitor in any area where it may become wet. Place the monitor on a stable surface.
- Unplug the unit during a lightning storm or if it will not be used for a long period of time. This will protect the monitor from damage due to power surges.
- Never push objects or spill liquid of any kind into the slots on the monitor cabinet.
- To ensure satisfactory operation, use the monitor only with UL listed computers which have appropriate configured receptacles marked between 100-240V AC.
- If you encounter technical problems with the monitor, contact a qualified service technician or your retailer.



This symbol of the crossed out wheeled bin indicates that the product (electrical, electronic equipment, and mercury-containing button cell battery) should not be placed in municipal waste. Please check local regulations for disposal of electronic products.

Care & Cleaning

- Before you lift or reposition your monitor, it is better to disconnect the cables and power cord. Follow the correct lifting techniques when positioning the monitor. When lifting or carrying the monitor, grasp the edges of the monitor. Do not lift the display by the stand or the cord.
- Cleaning. Turn your monitor off and unplug the power cord. Clean the monitor surface with a lint-free, non-abrasive cloth. Stubborn stains may be removed with a cloth dampened with mild cleaner.
- Avoid using a cleaner containing alcohol or acetone. Use a cleaner intended for use with the monitor. Never spray cleaner directly on the screen, as it may drip inside the monitor and cause an electric shock.

The following symptoms are normal with the monitor:

- You may find slightly uneven brightness on the screen depending on the desktop pattern you use.
- When the same image is displayed for hours, an afterimage of the previous screen may remain after switching the image. The screen will recover slowly or you can turn off the Power Switch for hours.
- When the screen becomes black or flashes, or cannot work anymore, contact your dealer or service center to fix it. Do not repair the screen by yourself!

Conventions used in this guide



WARNING: Information to prevent injury to yourself when trying to complete a task.



CAUTION: Information to prevent damage to the components when trying to complete a task.



IMPORTANT: Information that you **MUST** follow to complete a task.



NOTE: Tips and additional information to aid in completing a task.

Where to find more information

Refer to the following sources for additional information and for product and software updates.

1. ASUS websites

The ASUS websites worldwide provide updated information on ASUS hardware and software products. Refer to <http://www.asus.com>

2. Optional documentation

Your product package may include optional documentation that may have been added by your dealer. These documents are not part of the standard package.

1.1 Welcome!

Thank you for purchasing the ASUS® LCD monitor!

The latest widescreen LCD monitor from ASUS provides a broader, brighter and crystal-clear display, plus a host of features that enhance your viewing experience.

With these features, you can enjoy the convenience and delightful visual experience that the monitor brings to you!

1.2 Package contents

Check your package for the following items:

- ✓ LCD monitor
- ✓ Quick start guide
- ✓ Warranty card
- ✓ Power cord
- ✓ DVI-D cable (Dual Link)
- ✓ DisplayPort cable
- ✓ DisplayPort cable (Mini-DP to DP)
- ✓ USB 3.0 cable
- ✓ Support CD
- ✓ Cable tie
- ✓ Color Calibration Testing Report
- ✓ Hood



If any of the above items is damaged or missing, contact your retailer immediately.

1.3 Monitor introduction

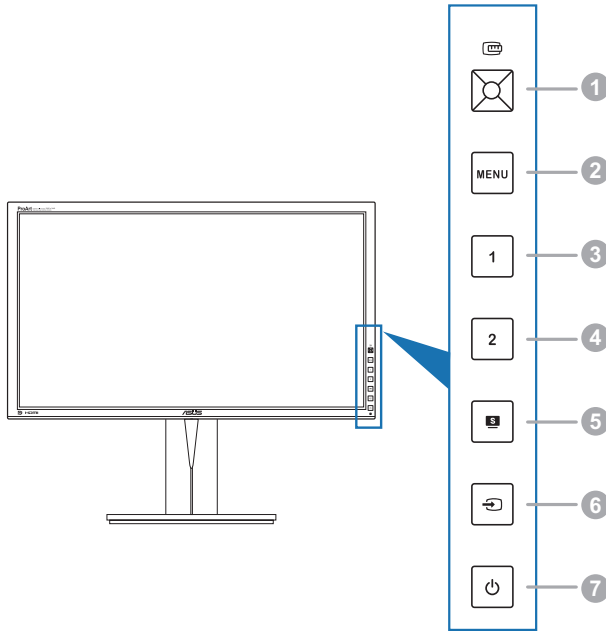

1.3.1 Front view



1.  QuickFit button:
 - Activates the QuickFit function designed for alignment.
 - The QuickFit function contains 7 pages of common grid patterns and paper and photo sizes. (Please refer to 1.3.3 QuickFit Function).
 - Enacts the selected OSD menu item.
 - Increases/Decreases values or moves your selection up/down/left/right.
2. MENU button:
 - Turns on the OSD menu.
 - Exits the OSD menu or goes back to the previous menu when the OSD menu is active.
 - Exits the QuickFit patterns.
 - Toggles the Key Lock function between on and off with a long press for 5 seconds.



The OSD menu is not available when the QuickFit function is in use.

3. **Shortcut 1**
 - Default: Brightness hotkey
 - To change the hotkey function, go to the Shortcut > Shortcut 1 menu.
4. **Shortcut 2**
 - Default: Contrast hotkey
 - To change the hotkey function, go to the Shortcut > Shortcut 2 menu.
5.  button:
 - Selects a desired preset mode.
6.  button:
 - Selects an available input source.



Press  button (Input Select button) to display HDMI/DisplayPort signals after you connect HDMI/DisplayPort cable with the monitor.

7.  Power button/power indicator
 - Turns the monitor on/off.
 - The color definition of the power indicator is as the below table.

Status	Description
White	On
Amber	Standby mode
Off	Off

1.3.2 Back view

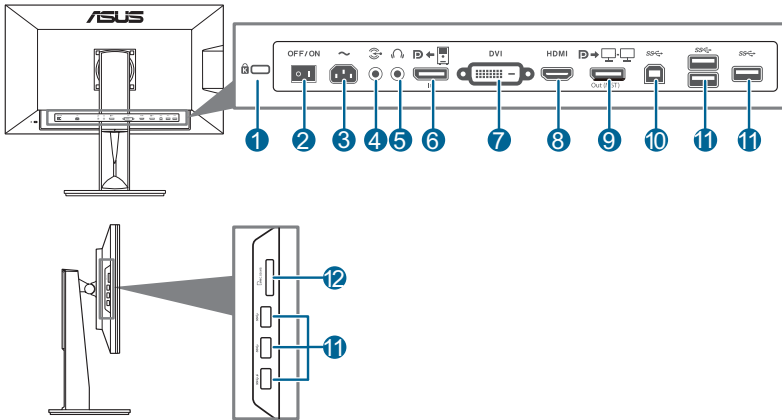

Rear connectors

1. **Kensington lock slot.**
2. **Power switch.** Press the switch to turn on/off power.
3. **AC-IN port.** This port connects the power cord.
4. **Audio-in port.** This port connects PC audio source by the bundled audio cable.
5. **Earphone jack.**
6. **DisplayPort in.** This port is for connection with your computer.
7. **DVI port.** This 24-pin port is for PC (Personal Computer) DVI-D digital signal connection.
8. **HDMI port.** This port is for connection with an HDMI compatible device.
9. **DisplayPort out.** This port allows you to connect multiple DisplayPort compatible monitors.
10. **USB 3.0 upstream port.** This port is for connection with a USB upstream cable. The connection enables the USB ports on the monitor.
11. **USB 3.0 downstream ports.** These ports are for connection with USB devices, such as USB keyboard/mouse, USB flash drive, etc.



This monitor is Super-Speed USB 3.0 compatible. Port with  icon is BC1.2 compliant.

12. **Card reader.** See below for more information about the card reader specifications.

Card reader specifications

- Support Ssecure Digital™ v1.0 / v1.1 / v2.0/ SDHC / SDXC (Capacity up to 2TB)
- Support Secure Digital™ v3.0 UHS-I (Ultra High Speed): SDR12/SDR25/SDR50/DDR50/SDR104
- Compliant with MultiMediaCard™ (MMC)
 - MMC specification v3.x / v4.0 / v4.1 / v4.2 / v4.3 / v4.4
 - x1 / x4
- Support Memory Stick PRO / Memory Stick PRO Duo / Memory Stick Micro / Memory
- Stick PRO-HG / Memory Stick XC (Capacity up to 32GB)
 - Compliant with Memory Stick Series Specification: MS v1.43, MS PRO v1.05, MS Micro v1.04 (MS HG Micro v1.00), MS PRO-HG Duo 1.03, MS XC Duo v1.00, MS XC-HG Duo v1.00, MS XC Micro v1.00 and MS XC-HG Micro v1.00
 - Support Read/Write quad data access (512Byte×4) for MS PRO-HG to enhance the transmission rate

1.3.3 QuickFit Function

The QuickFit function contains three kinds of patterns: (1) Grid patterns (2) Paper size (3) Photo size. To activate the patterns, press the QuickFit button. Press the button again until a desired pattern is selected. You can move the button up/down/left/right to change the pattern's position if needed. Note that all the patterns can be moved left/right according to your need, but may have limited range for moving up/down.

1. Grid patterns

The grid patterns facilitate designers and users to organize content and layout on a page and achieve a consistent look and feel.

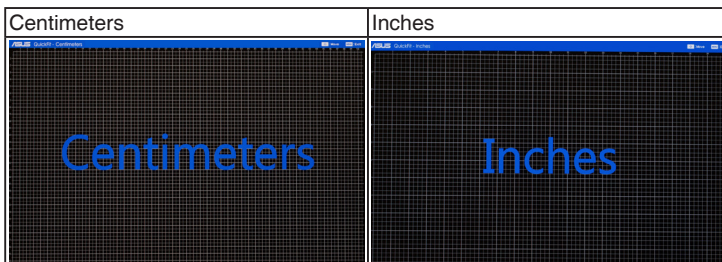



2. Paper size

QuickFit provides numerous commonly used standard paper sizes for users to view their documents in real size on the screen.

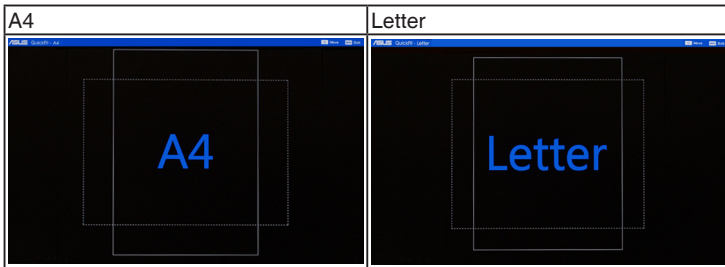

3. Photo size

The various real photo sizes displayed in the QuickFit function provides photographers and other users to accurately view and edit their photos in real size on the screen.

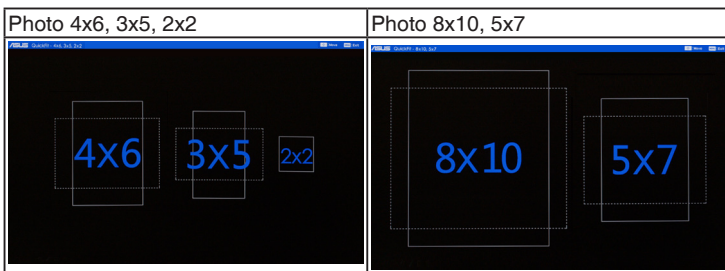

2.1 Detaching the arm/base (for VESA wall mount)

The detachable arm/base of this monitor is specially designed for VESA wall mount.

To detach the arm/base:

1. Have the front of the monitor face down on a table.
2. Use a screwdriver to remove the four screws on the arm (Figure 1), and then detach the arm/base from the monitor (Figure 2).

(Figure 1)

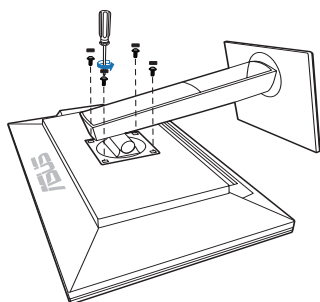

(Figure 2)

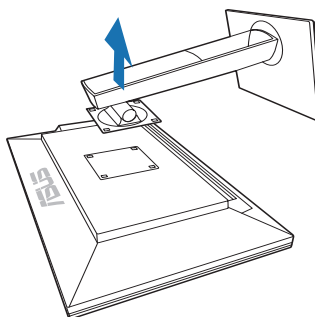

We recommend that you cover the table surface with soft cloth to prevent damage to the monitor.

2.2 Adjusting the monitor

- For optimal viewing, we recommend that you look at the full face of the monitor, then adjust the monitor to the angle that is most comfortable for you.
- Hold the stand to prevent the monitor from falling when you change its angle.
- You can adjust the monitor's angle from $+20^\circ$ to -5° , and it allows 60° swivel adjustment from either left or right. You can also adjust the monitor's height within ± 130 mm.

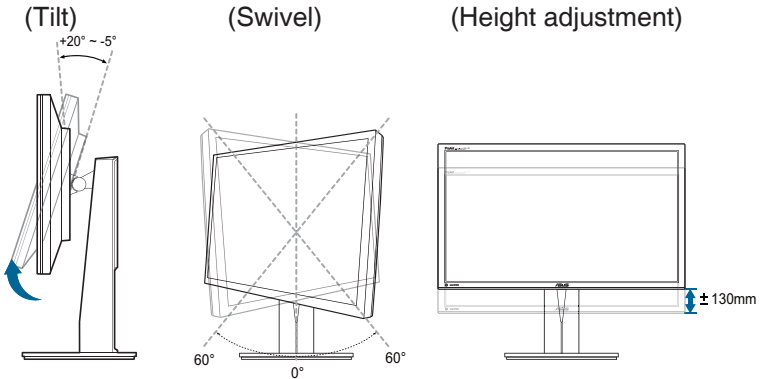

Pivoting the monitor

1. Lift the monitor to the highest position.
2. Tilt the monitor to its maximum angle.
3. Pivot the monitor clockwise to the angle you need.

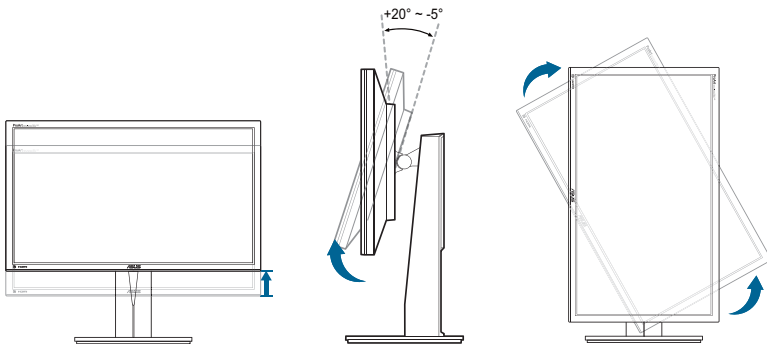

It is normal that the monitor slightly shakes while you adjust the viewing angle.

2.3 Connecting the cables

1. Connect the cables as the following instructions:

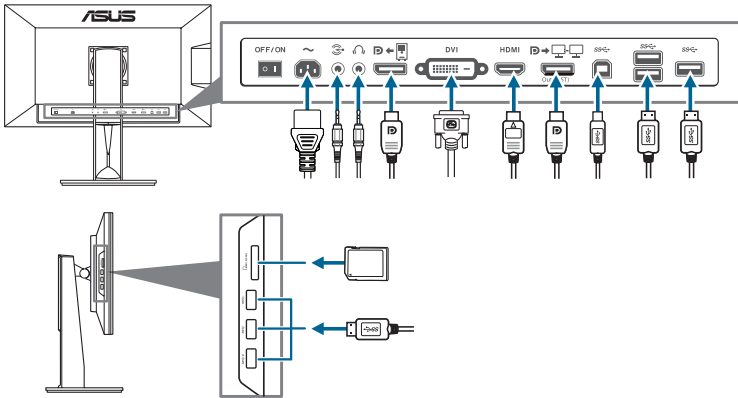



- **To connect the power cord:** connect one end of the power cord securely to the monitor's AC input port, the other end to a power outlet.
- **To connect the HDMI/DVI/DisplayPort cable:**
 - a. Plug one end of the HDMI/DVI/DisplayPort cable to the monitor's HDMI/DVI/DisplayPort jack.
 - b. Connect the other end of the HDMI/DVI/DisplayPort cable to your computer's HDMI/DVI/DisplayPort jack.
 - c. Tighten the two screws to secure the DVI connector.
- **To use the earphone:** connect the end with plug type to the monitor's earphone jack when an HDMI or DisplayPort signal is fed.
- **To use the USB 3.0 ports:** Take the supplied USB 3.0 cable, and plug the smaller end (type B) of the USB upstream cable to the monitor's USB upstream port, and the larger end (type A) to your computer's USB 3.0 port. Make sure your computer is installed with the latest Windows 7/Windows 8 operating system. That will enable the USB ports on the monitor to work.



When these cables are connected, you can choose the desired signal from the Input Select item in the OSD menu.





2.4 Turning on the monitor

Press the power button . See page 1-2 for the location of the power button. The power indicator  lights up in white to show that the monitor is ON.

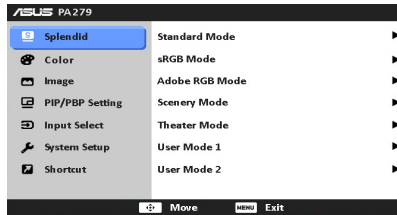
3.1 OSD (On-Screen Display) menu

3.1.1 How to reconfigure



1. Press the MENU button to activate the OSD menu.
2. Move the  button up/down to navigate through the functions. Highlight the desired function and press the  button to activate it. If the function selected has a sub-menu, move the  button up/down to navigate through the sub-menu functions. Highlight the desired sub-menu function and press the  button to activate it.
3. Move the  button left/right to change the settings of the selected function.
4. To exit and save the OSD menu, press the MENU button repeatedly until the OSD menu disappears. To adjust other functions, repeat steps 1-3.

3.1.2 OSD function introduction

1. Splendid

This function contains 7 sub-functions you can select for your preference. Each mode has the Reset selection, allowing you to maintain your setting or return to the preset mode.

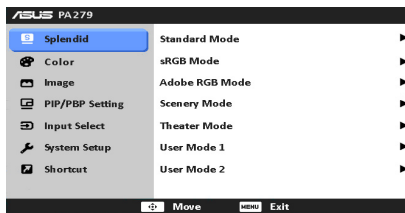

- **Standard Mode:** best choice for document editing with SPLENDID™ Video Enhancement.
- **sRGB Mode:** compatible with sRGB color space, sRGB mode is the best choice for document editing.

Color Space	White Point		Primaries					
	Xw	Yw	Xr	Yr	Xg	Yg	Xb	Yb
sRGB	0.3127	0.329	0.64	0.33	0.3	0.6	0.15	0.06

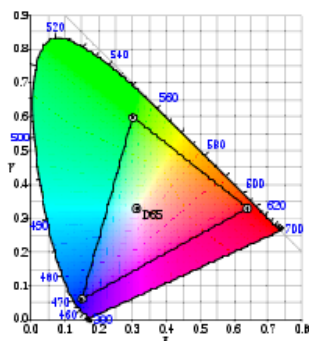

- **Adobe RGB Mode:** compatible with Adobe RGB color space.

Color Space	White Point		Primaries					
	Xw	Yw	Xr	Yr	Xg	Yg	Xb	Yb
Adobe RGB	0.3127	0.329	0.64	0.33	0.21	0.71	0.15	0.06

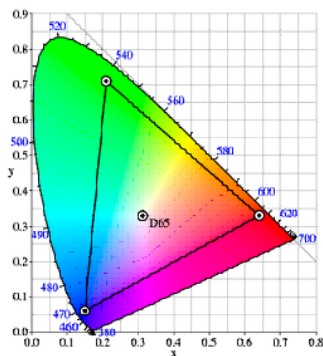

- **Scenery Mode:** best choice for scenery photo display with SPLENDID™ Video Enhancement.
- **Theater Mode:** best choice for movies with SPLENDID™ Video Enhancement.
- **User Mode 1/User Mode 2:** More items are adjustable in the Color menu.

Function	Standard Mode	sRGB Mode	Adobe RGB Mode	Scenery Mode	Theater Mode	User Mode 1/ User Mode 2
Brightness	Yes	Yes	Yes	Yes	Yes	Yes
Contrast	Yes	No	No	Yes	Yes	Yes
Saturation	No	No	No	Yes	Yes	Yes
Hue	No	No	No	No	No	Yes
Color Temperature	Yes	No	No	Yes	Yes	Yes
Gamma	Yes	No	No	No	No	Yes
Uniformity compensation	Yes	No	No	No	No	Yes
Advanced Setting	Six-axis Hue	No	No	No	No	Yes
	Six-axis Saturation	No	No	No	No	Yes
	Gain	No	No	No	No	Yes
	Offset	No	No	No	No	Yes

2. Color

Set a desired color setting from this menu.

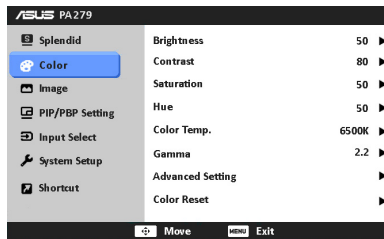

- **Brightness:** the adjusting range is from 0 to 100.
- **Contrast:** the adjusting range is from 0 to 100.
- **Saturation:** the adjusting range is from 0 to 100.
- **Hue:** shifts the image color between green and purple.
- **Color Temp.:** contains 4 modes including 9300K, 6500K, 5500K and 5000K.
- **Gamma:** allows you to set the color mode to 2.2 or 1.8.
- **Advanced Setting:**

- * 6-axis Hue adjustment.

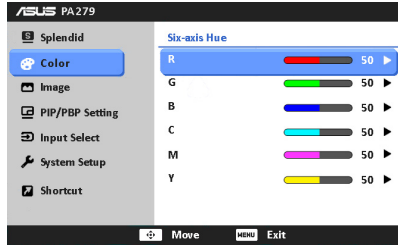

- * 6-axis Saturation adjustment.

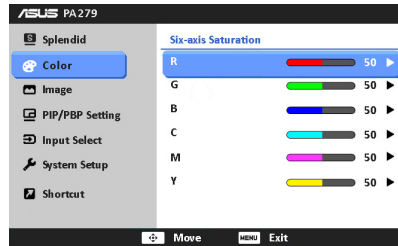

- * Adjusts the gain levels for R, G, B.
- * Adjusts the black level offset values for R, G, B.

- **Color Reset:**

- * Current Splendid color mode reset:
Resets the color settings of current color mode to the factory default value.
- * All Splendid color mode reset:
Resets the color settings of all color modes to the factory default value.

3. Image

Set the image related setting from this menu.

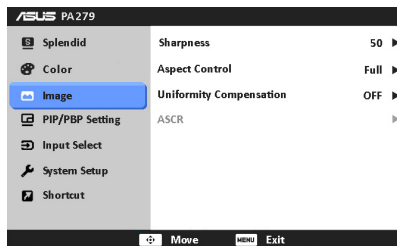

- **Sharpness:** the adjusting range is from 0 to 100.
- **Aspect Control:** adjusts the aspect ratio to full, 4:3, 1:1, or OverScan (only available for the HDMI input).

- **Uniformity Compensation:** adjusts different areas of the screen to reduce any screen uniformity errors, providing consistent brightness and color across the entire screen.
- **ASCR:** turns on/off the ASCR (ASUS Smart Contrast Ratio) function.

4. PIP/PBP Setting

The PIP/PBP Setting allows you to open up another sub-window connected from another video source besides the main-window from your original video source. By activating this function, you can have two pictures from two different video sources displayed by the monitor.

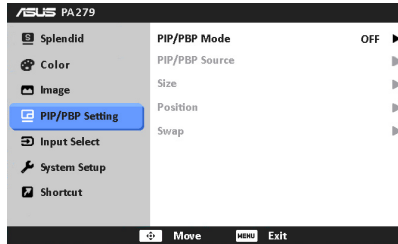

- **PIP/PBP Mode:** turns the PIP or PBP function on or off.
- **PIP/PBP Source:** Selects the video input source from among DVI, HDMI, and DisplayPort.
- **Size:** Adjusts the PIP size to Small, Middle, or Large. (Only available for the PIP mode)
- **Position:** Adjusts the position of the sub-window to Right-Top, Left-Top, Right-Bottom, or Left-Bottom. (Only available for the PIP mode)
- **Swap:** Switches the sources of the main and sub-windows.



The DVI and HDMI input sources should not be selected as the main-window or sub-window at the same time. See the table below for details.

		Main-window		
		DVI	HDMI	DisplayPort
Sub-window	DVI		No	Yes
	HDMI	No		Yes
	DisplayPort	Yes	Yes	

5. Input Select

In this function, you can select your desired input source.

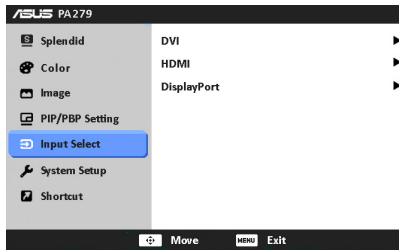

6. System Setup

Allows you to adjust the system.

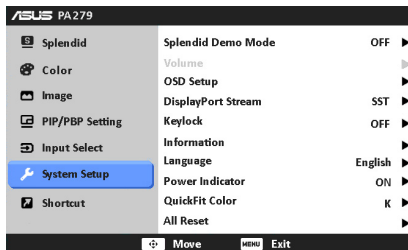

- **Splendid Demo Mode:** splits the screen into two for Splendid modes comparison. (Scenery mode/theater mode only)
- **Volume:** the adjusting range is from 0 to 100.
- **OSD Setup:**
 - * Adjusts the horizontal position (H-Position)/the vertical position (V-Position) of the OSD from 0 to 100.
 - * Adjusts the OSD timeout from 10 to 120 seconds.
 - * Enables or disables the DDC/CI function.
 - * Adjusts the OSD background from opaque to transparent.
 - * Adjusts the OSD rotation.
- **DisplayPort Stream:** supports SST (single-stream transport) and MST (multi-stream transport) . When using the multi-stream transport, images may not be displayed properly with some video card combinations.



The default setting is SST. When using the daisy chain function, be sure to select MST first.

- **Keylock:** To disable all function keys. Press the NEMU button over five seconds to cancel the key lock function.
- **Information:** shows the monitor information.

- **Language:** there are 21 languages for your selection, including English, French, German, Italian, Spanish, Dutch, Portuguese, Russian, Czech, Croatia, Polish, Romanian, Hungarian, Turkey, Simplified Chinese, Traditional Chinese, Japanese, Korean, Thai, Indonesia, Persian.
- **Power Indicator:** turns the power LED indicator on/off.
- **QuickFit Color:** adjusts the QuickFit color among 7 preset colors.
- **All Reset:** “Yes” allows you to restore the default settings.

7. Shortcut

Defines the functions for Shortcut 1 and 2 buttons.

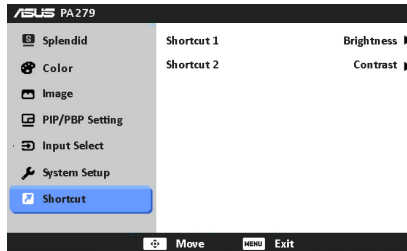

- **Shortcut 1/Shortcut 2:** selects a function for Shortcut 1 and 2 buttons.



When a certain function is selected or activated, your shortcut key may not support. See the table below for details.

Function selected or activated	The defined shortcut key not support
ASCR	Brightness
sRGB	Contrast/Color Temp./Advanced Setting
PBP	OSD Rotation
OSD Rotation	PIP/PBP Setting
Standard/Scenery/Theater	Advanced Setting
DVI	Volume
QuickFit	All, except for QuickFit Color

3.2 Specifications summary

Panel Type	TFT LCD
Panel size	27.0" (16:9, 68.47 cm) wide screen
Max. Resolution	2560 x 1440
Pixel pitch	0.270 mm
Brightness (Typ.)	350 cd/m ²
Contrast Ratio (Typ.)	1000:1
Contrast Ratio (Max.)	100,000,000:1 (with ASCR on)
Viewing angle (H/V) CR>10	178°/178°
Display colors	1.07 B
Response time	6 ms (Gray to gray)
SPLendid™ Video Enhancement	Yes
SPLendid™ selection	7 video preset modes (by hotkey)
Auto adjustment	No
Color temperature selection	4 color temperatures
Digital input	HDMI v1.4, DisplayPort V1.2, DVI-D (Dual link) with HDCP
Earphone jack	Yes
USB 3.0 port	Upstream x 1, Downstream x 6
Colors	Black
Power LED	White (On)/Amber (Standby)
Tilt	+20° ~ -5°
Swivel	+60° ~ -60°
Height Adjustment	130 mm
Kensington lock	Yes
AC input voltage	AC: 100~240V
Power consumption	Power On: < 49 W (Typ.), Standby: < 0.5 W (Typ.), Power Off: 0 W (Switch off)
Temperature (Operating)	5°C~35°C
Temperature (Non-operating)	-20°C~+60°C
Dimension (W x H x D)	640.78 mm x 559.84 mm x 240 mm (machine) 756 mm x 456 mm x 300 mm (package)
Weight (Esti.)	10.0 kg (Net); 14.0 kg (Gross)
Multi-languages	21 languages (English, French, German, Italian, Spanish, Dutch, Portuguese, Russian, Czech, Croatia, Polish, Romanian, Hungarian, Turkey, Simplified Chinese, Traditional Chinese, Japanese, Korean, Thai, Indonesia, Persian)
Accessories	DVI-D (Dual link) cable, HDMI cable, DisplayPort cable, DisplayPort cable (Mini-DP to DP) , Power cord, USB 3.0 cable, Quick start guide, Warranty card, Support CD, Cable tie, Color Calibration Testing Report
Regulation approvals	Energy Star, China Energy Level 2, EPEAT Gold, UL/cUL, CB, CE, EuP, FCC (Class B), CCC, BSMI, CU, C-Tick, VCCI, TCO6.0, TUV-GS, TUV-Ergo, Ukraine, J-MOSS, RoHS, WEEE, PSE, Windows 7 & 8 WHQL, Mac Compliance**

*Specifications are subject to change without notice.

**Requires Mac OS X v10.x

3.3 Troubleshooting (FAQ)

Problem	Possible Solution
Power LED is not ON	<ul style="list-style-type: none">• Press the  button to check if the monitor is in the ON mode.• Check if the power cord is properly connected to the monitor and the power outlet.• Check if the power switch is ON.
The power LED lights amber and there is no screen image	<ul style="list-style-type: none">• Check if the monitor and the computer are in the ON mode.• Make sure the signal cable is properly connected to the monitor and the computer.• Inspect the signal cable and make sure none of the pins are bent.• Connect the computer with another available monitor to check if the computer is properly working.
Screen image is too light or dark	<ul style="list-style-type: none">• Adjust the Contrast and Brightness settings via OSD.
Screen image is not centered or sized properly	<ul style="list-style-type: none">• Adjust the H-Position or V-Position settings via OSD.
Screen image bounces or a wave pattern is present in the image	<ul style="list-style-type: none">• Make sure the signal cable is properly connected to the monitor and the computer.• Move electrical devices that may cause electrical interference.
Screen image has color defects (white does not look white)	<ul style="list-style-type: none">• Inspect the signal cable and make sure that none of the pins are bent.• Perform All Reset via OSD.• Adjust the R/G/B color settings or select the Color Temperature via OSD.
Screen image is blurry or fuzzy	<ul style="list-style-type: none">• Adjust the Phase and Clock settings via OSD.
No sound or sound is low	<ul style="list-style-type: none">• Ensure that the HDMI/DisplayPort cable is properly connected to the monitor and the computer.• Adjust the volume settings of both your monitor and HDMI/DisplayPort device.• Ensure that the computer sound card driver is properly installed and activated.

3.4 Supported operating modes

Resolution Frequency	Horizontal Frequency (KHz)	Vertical Frequency (Hz)	Pixel (MHz)
640x480	31.47(N)	59.94(N)	25.18
640x480	35.00(N)	66.66(N)	30.24
640x480	37.87(N)	72.82(N)	31.5
640x480	37.5(N)	75.00(N)	31.5
720x400	31.47(N)	70.08(P)	28.32
800x600	35.16(P)	56.25(P)	36
800x600	37.88(P)	60.32(P)	40
800x600	48.08(P)	72.12(P)	50
800x600	46.86(P)	75.00(P)	49.5
832X624	49.72(P/N)	74.55(P/N)	57.28
1024x768	48.36(N)	60.00(N)	65
1024x768	56.476(N)	70.069(N)	75
1024x768	60.02(N)	75.00(N)	78.75
1152x864	67.5(P/N)	75.00(P/N)	108
1280x960	60.00(P)	60.00(N)	108
1280x1024	63.98(P)	60.02(P)	108
1280x1024	79.98(P)	75.02(P)	135
1366x768	47.712(P)	59.79(P)	85.5
1440x900	55.94(N)	59.89(P)	106.5
1600x1200	75.00(P)	60.00(P)	162
1680x1050	65.29(N)	60.00(P)	146.25
1920x1080	67.5(P)	60.00(P)	148.5
1920x1200 (Reduced Blanking)	74.038(P)	59.95(N)	154
1920x1200	74.556(N)	59.885(P)	193.25
2560x1080	66.636(P)	59.978(N)	181.25
2560x1440	88.787(P)	59.951(N)	241.50

When the monitor is operating in the video mode (ie, not displaying data) using the HDMI connector, the following high definition modes shall be supported in addition to standard definition video

Timing Name	Pixel Format	Horizontal Frequency (KHz)	Vertical Frequency (Hz)
480p	720x480	31.469	60
720p60	1280x720	45	60
576p	720x576	31.25	50
720p50	1280x720	37.5	50
1080p60	1920x1080	67.5	60
1080p50	1920x1080	56.25	50

* Modes not listed in the table may not be supported. For optimal resolution, we recommend that you choose a mode listed in the table above.