



USER GUIDE

LG Digital Signage (MONITOR SIGNAGE)

Please read this manual carefully before operating your set and retain it for future reference.

L15

TABLE OF CONTENTS

USING THE MONITOR 3

- Using the Input List 3
- Adjusting Aspect Ratio 3

ENTERTAINMENT 5

- Using the Network..... 5
 - Connecting to a Network
 - Network Status
- Using the My Media 7
 - Connecting USB storage devices
 - Browsing Files
 - Viewing Movies
 - Viewing Photos
 - Listening to Music
 - Viewing the Contents List

CUSTOMIZING SETTINGS 20

- Accessing Main Menus 20
 - PICTURE Settings
 - AUDIO Settings
 - TIME Settings
 - OPTION Settings
 - NETWORK Settings
- PICTURE ID Settings..... 30

IR CODES 31

TO CONTROL MULTIPLE PRODUCTS 33

- Connecting the Cable 33
- RS-232C Configurations 34
 - 4P Cable
 - RS-232C Cable
- Communication Parameter 34
- Command Reference List 35
- Transmission / Receiving Protocol..... 37

To obtain the source code under GPL, LGPL, MPL, and other open source licenses, that is contained in this product, please visit <http://opensource.lge.com>.

In addition to the source code, all referred license terms, warranty disclaimers and copyright notices are available for download. LG Electronics will also provide open source code to you on CD-ROM for a charge covering the cost of performing such distribution (such as the cost of media, shipping, and handling) upon email request to opensource@lge.com. This offer is valid for three (3) years from the date on which you purchased the product.

USING THE MONITOR

Using the Input List

- 1 Press **INPUT** to access the **Input List**.
- 2 Press the navigation buttons to scroll to one of the input mode and press **OK**.

- **RGB-PC**
- **HDMI**
- **DVI-D**
- **USB**
- **Display Port**
- **OPS**

NOTE

- Some input signals may not be supported depending on the model.

Adjusting Aspect Ratio

Resize the image to view the image at its optimal size by pressing ARC while you are watching monitor set.

MODE	RGB	HDMI		DVI-D		Display Port		OPS	
	PC	DTV	PC	DTV	PC	DTV	PC	DTV	PC
Aspect Ratio									
16:9	o	o	o	o	o	o	o	o	o
Just Scan	x	o	x	o	x	o	x	o	x
Set By Program	x	o	x	o	x	o	x	o	x
4:3	o	o	o	o	o	o	o	o	o
Zoom	x	o	x	o	x	o	x	o	x
Cinema Zoom1	x	o	x	o	x	o	x	o	x

NOTE

- You can also change the image size by accessing the main menus.
- The Just Scan mode operates when a video signal has resolution of 720p or higher.

CAUTION

- If a fixed image displays on the screen for a long period of time, it will be imprinted and become a permanent disfigurement on the screen. This is image burn or burn-in and not covered by the warranty.
- If you don't use your monitor, turn the power off or set a screen saver program from the PC or the system to prevent image retention.
- If the aspect ratio is set to 4:3 for a long period of time, image burn may occur on the letterboxed area of the screen.

- **16:9** : This selection will allow you to adjust the picture horizontally, in linear proportion, to fill the entire screen (useful for viewing 4:3 formatted DVDs).
- **Just Scan** : This Selection will allow you view the picture of best quality without loss of original picture in high resolution image. Note: If there is noise in original Picture, You can see the noise at the edge.
- **Set By Program** : Depending on the input signal, screen aspect ratio changes to 4:3 or 16:9.
- **4:3** : This selection will allow you to view a picture with an original 4:3 aspect ratio, black bars will appear on both the left and right of the screen.
- **Zoom** : This selection will allow you to view the picture without any alteration, while filling the entire screen. However, the top and bottom of the picture will be cropped.
- **Cinema Zoom1** : Choose Cinema Zoom when you want to enlarge the picture in correct proportion.
Note: When enlarging or reducing the picture, the image may become distorted.

ENTERTAINMENT

Using the Network

Connecting to a Network

For wired network connections, connect the display to a local area network (LAN) via the LAN port as shown on the following diagram. Then, set up the network settings. For wireless network connections, connect the Wi-Fi USB module to the USB port. Then, set up the network settings.

After making a physical connection, a small number of home networks may require the display network settings to be adjusted. For most home networks, the display will connect to automatically without any adjustments.

For detail information, contact your internet provider or router manual.

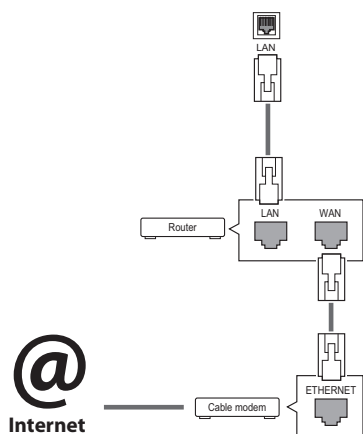

To set up the network settings: (Even if your display has already connected automatically, running setup again will not harm anything),

Connecting to a wired network

- 1 Press **SETTINGS** to access the main menus.
- 2 Press the navigation buttons to scroll to **NETWORK** and press **OK**.
- 3 Press the navigation buttons to select **Network Setting** and press **OK**.
- 4 If you already set network setting, select **Resetting**. The new connection settings resets the current network settings.
- 5 Select **IP Auto Setting** or **IP Manual Setting**.
 - **IP Manual Setting**
press the navigation and number buttons. IP addresses will need to be input manually.
 - **IP Auto Setting**
Select this if there is a DHCP server (Router) on the local area network (LAN) via wired connection, the display will automatically be allocated an IP address. If you're using a broadband router or broadband modem that has a DHCP (Dynamic Host Configuration Protocol) server function. The IP address will automatically be determined.
- 6 When you are finished, press **EXIT**.

CAUTION

- Do not connect a modular phone cable to the LAN port.
- Since there are various connection methods, please follow the specifications of your telecommunication carrier or internet service provider.

Connecting to a wireless network

- 1 Press **SETTINGS** to access the main menus.
- 2 Press the navigation buttons to scroll to **NETWORK** and press **OK**.
- 3 Press the navigation buttons to select **Network Setting** and press **OK**.
- 4 **Select Setting from the AP list or Simple setting (WPS-button mode).**
-Setting from the AP list
 Select an AP to connect to a wireless network.
-Simple setting (WPS-button mode)
 Press the button on the wireless router that supports PBC to easily connect to the router.
- 5 When you are finished, press **EXIT**.



CAUTION

- Network setting menu will not be available until the display connected to physical network.
- Since there are various connection methods, please follow the specifications of your telecommunication carrier or internet service provider.
- When a Wi-Fi dongle is used with a model that has only one USB input port, the distribution or content schedule via the SuperSign software is not available.



NOTE

- If you want to access the Internet directly on your display, the Internet connection should always be on.
- If you cannot access the Internet, check the network conditions from a PC on your network.
- When you use Network Setting, check the LAN cable or check if DHCP in the router is turned on.
- If you do not complete the network settings, the network may not work properly.

Tips for Network setting

- Use a standard LAN cable with this display. Cat5 or better with a RJ45 connector.
- Many network connection problems during set up can often be fixed by re-setting the router or modem. After connecting the display to the home network, quickly power off and/or disconnect the power cable of the home network router or cable modem. Then power on and/or connect the power cable again.
- Depending on the internet service provider (ISP), the number of devices that can receive internet service may be limited by the applicable terms of service. For details, contact your ISP.
- LG is not responsible for any malfunction of the display and/or the internet connection feature due to communication errors/malfunctions associated with your internet connection, or other connected equipment.
- LG is not responsible for problems within your internet connection.
- You may experience undesired results if the network connection speed does not meet the requirements of the content being accessed.
- Some internet connection operations may not be possible due to certain restrictions set by the Internet service provider (ISP) supplying your Internet connection.
- Any fees charged by an ISP including, without limitation, connection charges are your responsibility.
- A 10 Base-T or 100 Base-TX LAN port is required when using a wired connection to this display. If your internet service does not allow for such a connection, you will not be able to connect the display.
- A DSL modem is required to use DSL service and a cable modem is required to use cable modem service. Depending on the access method of and subscriber agreement with your ISP, you may not be able to use the Internet connection feature contained in this display or you may be limited to the number of devices you can connect at the same time. (If your ISP limits subscription to one device, this display may not be allowed to connect when a PC is already connected.)
- The use of a router may not be allowed or its usage may be limited depending on the policies and restrictions of your ISP. For details, contact your ISP directly.

Tips for Wireless Network Setting

- Wireless networks can be subject to interference from other devices operating at a frequency of 2.4 GHz (wireless phones, Bluetooth devices, or microwave ovens). There may also be interference from devices with a frequency of 5 GHz, same as other Wi-Fi devices.
- The surrounding wireless environment can cause the wireless network service to run slowly.
- For an AP connection, an access point device that supports wireless connection is required and the wireless connection feature must be enabled on the device. Contact your service provider regarding availability of wireless connection on your access point.
- Check the SSID and security settings of the AP for AP connection. Refer to the appropriate documentation for SSID and security settings of the AP.
- Invalid settings on network devices (wired/wireless line sharer, hub) can cause the monitor to run slowly or not operate properly. Install the devices correctly according to the appropriate manual and set the network.
- Connection method may differ according to the AP manufacturer.

Network Status

- 1 Press **SETTINGS** to access the main menus.
- 2 Press the navigation buttons to scroll to **NETWORK** and press **OK**.
- 3 Press the navigation buttons to select **Network Status**.
- 4 Press **OK** to check the network status.
- 5 When you are finished, press **EXIT**.

Option	Description
Setting	Return to the network setting menu.
Test	Test the current network status after setting the network.
Close	Return to the previous menu.

Using the My Media

Connecting USB storage devices

Connect USB storage devices such as a USB flash memory, external hard drive to the display and use multimedia features.

Connect a USB flash memory or USB memory card reader to the Display as shown on the following illustration. The **My Media** screen appears.

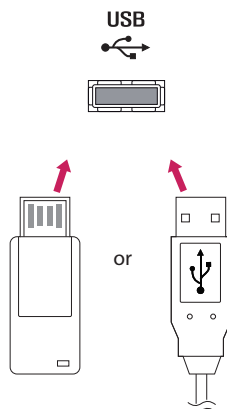

CAUTION

- Do not turn the display off or remove a USB storage device while **MY MEDIA** menu is activated, as this could result in loss of files or damage to the USB storage device.
- Back up your files saved on a USB storage device frequently, as you may lose or damage the files and this may be not covered by the warranty.

Tips for using USB storage devices

- Only a USB storage device is recognizable.
- If the USB storage device is connected through a USB hub, the device is not recognizable.
- A USB storage device using an automatic recognition program may not be recognized.
- A USB storage device which uses its own driver will not be recognized.
- The recognition speed of a USB storage device may depend on each device.
- Please do not turn off the display or unplug the USB device when the connected USB storage device is working. When such a device is suddenly separated or unplugged, the stored files or the USB storage device may be damaged.
- Please do not connect the USB storage device which was artificially maneuvered on the PC. The device may cause the product to malfunction. Only use a USB storage device which has normal music files, image files or movie files.
- Please only use USB storage devices formatted using the FAT32 file system. Storage devices formatted with utility programs that are not supported by Windows may not be recognized.
- Please connect power to a USB storage device (over 0.5 A) which requires an external power supply. If not, the device may not be recognized.
- Please connect a USB storage device with the cable included by the device maker.
- Some USB storage devices may not be supported or operate smoothly.
- File alignment method of USB storage devices is similar to Window XP and the monitor can recognize up to 100 English characters.
- Be sure to back up important files since data stored on a USB memory device may be damaged. We will not be responsible for any data loss.
- If the USB HDD does not have an external power source, the USB device may not be detected. So be sure to connect the external power source.
 - Please use a power adaptor for an external power source.
- If your USB memory device has multiple partitions, or if you use a USB multi-card reader, you can use up to 4 partitions or USB memory devices.
- If a USB memory device is connected to a USB multi-card reader, its volume data may not be detected.
- If the USB memory device does not work properly, disconnect and reconnect it.
- How fast a USB memory device is detected differs from device to device.
- If the USB is connected in Standby Mode, that drive will automatically be loaded when the display is turned on.
- The recommended capacity is 1 TB or less for a USB external hard disk and 32 GB or less for USB memory.
- Any device with more than the recommended capacity may not work properly.
- If a USB external hard disk with a Energy Saving function does not work, turn the hard disk off and on again to make it work properly.
- USB storage devices below USB 2.0 are supported as well. But they may not work properly with videos.
- A maximum of 999 folders or files can be recognized under one folder.
- It is recommended you use a certified USB storage device and cable. Otherwise, a USB storage device may not be detected or a playback error may occur.
- Only a USB memory device can be used to playback the files distributed and stored by SuperSign Manager. A USB hard disk or multi-card reader will not work.
- Only an FAT 32 file formatted storage device can playback the files distributed and stored by SuperSign manager.
- A USB 3.0 storage device may not work.
- Data on some USB storage devices may be damaged in a high temperature environment.
- It is recommended that you avoid playing contents using more than two USB ports simultaneously.

Browsing Files

Browse files saved in a USB storage device.

- 1 Press **SETTINGS** to access the main menu.
- 2 Press the search button to scroll to **MY MEDIA** and press **OK**.
- 3 Press the Search button to go to the **Movie List, Photo List, Music List, or Content List** that you want, and press **OK**.

Supported file format









Type	Supported file format			
Movie	Video	Codec	Media Container	Profile
		MPEG1 / MPEG2	DAT, MPG, MPEG, TS, TP	1080P @ 30 fps
		MPEG4 (DivX 3.11, DivX 4, DivX 5, DivX 6, Xvid 1.01, Xvid 1.02, Xvid 1.03, Xvid 1.10-beta1/2)	AVI, DIVX, MP4, MKV, TS, TRP	1080P @ 30 fps
	H.264	AVI, MP4, MKV, TS, TRP, TP	1080P @ 60 fps	
	Audio	MP3	MP3	8 kbps to 320 kbps (Bit rate) 16 kHz to 48 kHz (Sample rate)
		AC3	AC3	32 kbps to 640 kbps (Bit rate) 32 kHz, 44.1 kHz, 48 kHz (Sample rate)
		MPEG	MP3	32 kbps to 448 kbps (Bit rate) 16 kHz to 48 kHz (Sample rate)
		AAC, HEAAC	MP4	8 kHz to 48 kHz (Sample rate)
		LPCM	AVI, WAV	64 kbps to 1.5 Mbps (Bit rate) 8 kHz to 48 kHz (Sample rate)
	Bit rate : within 8 kbps to 320 kbps(MP3) External Subtitle format : *.smi/*srt/*sub(MicroDVD, Subviewer1.0/2.0)/*.ass/*ssa/*txt(TMPlayer)/ *.psb(PowerDivX) Internal Subtitle format : only, XSUB (It is the subtitle format used in DivX6 files)			

Type	Supported file format
Photo	<p>JPEG Min : 64 x 64 Max : Normal Type: 15360 (W) x 8640 (H) Progressive Type: 1920 (W) x 1440 (H)</p> <p>BMP Min : 64 x 64 Max : 9600 x 6400</p> <p>PNG Min : 64 x 64 Max : Interlace: 1200 x 800 Non-Interlace: 9600 x 6400</p> <ul style="list-style-type: none"> • Non-supported files are displayed in the form of predefined icon.
Music	<p>mp3 [Bit rate] 32 kbps ~ 320 kbps [Sample freq.] 16 kHz ~ 48 kHz [Support] MPEG1, MPEG2, Layer2, Layer3</p> <p>AAC [Bit rate] Free Format [Sample freq.] 8 kHz ~ 48 kHz [Support] ADIF, ADTS</p> <p>M4A [Bit rate] Free Format [Sample freq.] 8 kHz ~ 48 kHz [Support] MPEG-4</p> <p>OGG [Bit rate] Free Format [Sample freq.] ~ 48 kHz [Support] Vorbis</p> <p>WMA [Bit rate] 128 kbps ~ 320 kbps [Sample freq.] 8 kHz ~ 48 kHz [Support] WMA7, 8, 9 Standard</p> <p>WMA 10 Pro [Bit rate] ~768 kbps [Channel / Sample freq.] M0 : Up to 2 / 48 kHz M1 : Up to 5.1 / 48 kHz M2 : Up to 5.1 / 96 kHz [Support] WMA 10 Pro</p>
Content (when using SuperSign Manager)	<p>File Extensions : *.cts/* .sce Movie File Extensions: *.mpg/* .mpeg/* .dat/* .ts/* .trp/* .tp/* .mp4/* .mkv/* .avi/* .avi(motion JPEG)/* .mp4(motion JPEG)/* .mkv(motion JPEG)</p> <p>Video format: MPEG1, MPEG2, MPEG4,H.264, DivX 3.11, DivX 4, DivX 5, DivX 6, Xvid 1.00,Xvid 1.01, Xvid 1.02, Xvid 1.03,Xvid 1.10-beta1/2, JPEG</p> <p>Audio format: MP3, Dolby Digital, LPCM, AAC, HE-AAC</p>

Viewing Movies

Plays movie files saved in the USB storage device.

- 1 Press **SETTINGS** to access the main menu.
- 2 Press the navigation button to scroll to **MY MEDIA** and press **OK**.
- 3 Press the navigation button to scroll to **Movie List** and press **OK**.
- 4 Press the navigation buttons to scroll to a folder you want and press **OK**.
- 5 Press the navigation buttons to scroll to a file you want and press **OK**.
 - **Change Device** : Selects the USB storage device. (Depending on model)
 - **Go to root folder** : Returns to the home screen of My Media.
 - **Go to upper folder** : Returns to the previous screen.
 - **Exit** : Exits My Media.
- 6 During movie playback, press **OK** to access the following settings.

Remote button	Description
	Stops the playback.
	Plays a video.
	Pauses or resumes the playback.
	Scans backward in a file.
	Scans forward in a file.
	Adjusts the screen brightness to save energy.
SETTINGS	Show the Option menu.
 BACK	Hide the menu on the full-sized screen.
EXIT	Returns to Movie List .
	Skips to specific points in a file during playback. The time of a specific point will appear on the status bar. In some files, this function may not work properly.

Tips for using playing video files

- Some user-created subtitles may not work properly.
- Some special characters are not supported in subtitles.
- HTML tags are not supported in subtitles.
- Subtitles in languages other than the supported languages are not available.
- The screen may suffer temporary interruptions (image stoppage, faster playback, etc.) when the audio language is changed.
- A damaged movie file may not be played correctly, or some player functions may not be usable.
- Movie files produced with some encoders may not be played correctly.
- If the video and audio structure of recorded file is not interleaved, either video or audio is outputted.
- HD videos with a maximum of 1920 x 1080 @ 25/30p or 1280 x 720 @ 50/60p are supported, depending on the frame.
- Videos with resolutions higher than 1920 x 1080 @ 25/30p or 1280 x 720 @ 50/60p may not work properly depending on the frame.
- Movie files other than the specified types and formats may not work properly.
- Max bitrate of playable movie file is 20 Mbps. (only, Motion JPEG : 10 Mbps)
- We do not guarantee smooth playback of profiles encoded level 4.1 or higher in H.264/AVC.
- DTS Audio codec is not supported.
- A movie file more than 30 GB in file size is not supported for playback.
- A DivX movie file and its subtitle file must be located in the same folder.
- A video file name and its subtitle file name must be identical for it to be displayed.
- Playing a video via a USB connection that doesn't support high speed may not work properly.
- Files encoded with GMC(Global Motion Compensation) may not be played.

Video options

- 1 Press **SETTINGS** to access the Pop-Up menus.
- 2 Press the navigation buttons to scroll to **Set Video Play**, **Set Video**, or **Set Audio**, and press **OK**.

NOTE

- The option values changed in **Movie List** do not affect **Photo List** or **Music List**. Therefore, they are not affected by option values changed in **Photo List** or **Music List**.
- The option values changed in **Photo List** and **Music List** do affect each other.
- When replaying the video file after stopping, you can play from where it stopped previously.

Select **Set Video Play** to access the following menus:

Menu	Description
Picture Size	Selects your desired picture format during movie play.
Audio Language	Changes the Language Group of the audio during movie play. Files with a single audio track cannot be selected.
Subtitle Language	Turn on/off the subtitle.
Language	Activated for SMI subtitle and can select the language within the subtitle.
Code Page	Can select the font for subtitle. When set to default, same font as general menu will be used.
Sync	Adjusts the time synchronisation of the subtitle from -10 secs to +10 secs by steps of 0.5 secs during movie play.
Position	Changes the position of the subtitle either up or down during movie play.
Size	Selects your desired Subtitle size during movie play.
Repeat	Turn on/off repeat function of movie playback. When turned on, the file within the folder will be played back repeatedly. Even when the repeated playback is turned off, it can run the playback if the file name is similar to the previous file.

NOTE

- Only 10,000 of sync blocks can be supported within the subtitle file.
- When playing a video, you can adjust the picture size by pressing the **ARC** button.
- Subtitles in your language are only supported when the OSD menu is also in this language.
- The code page options may be disabled depending on the language of the subtitle files.
- Select the appropriate code page for the subtitle files.

Viewing Photos

View image files saved in the USB storage device.

- 1 Press **SETTINGS** to access the main menu.
- 2 Press the navigation button to scroll to **MY MEDIA** and press **OK**.
- 3 Press the navigation button to scroll to **Photo List** and press **OK**.
- 4 Press the navigation buttons to scroll to a folder you want and press **OK**.
- 5 Press the navigation buttons to scroll to a file you want and press **OK**.

- **Change Device** : Selects the USB storage device. (Depending on model)
- **Go to root folder** : Returns to the home screen of My Media.
- **Go to upper folder** : Returns to the previous screen.
- **Exit** : Exits My Media.

- 6 While viewing photos, you can access the following settings.





Menu	Description
Slideshow	Starts or stops a slideshow with selected photos. If there are no selected photos, all photos saved in the current folder display during a slideshow. To set a slideshow speed, select Option .
BGM	Turns the background music on or off. To set the background music folder, select Option . You can adjust option by SETTINGS button on the remote control.
	Rotates photos clockwise (90 °, 180 °, 270 °, 360 °).  NOTE <ul style="list-style-type: none"> • The supported photo size is limited. You cannot rotate a photo if the resolution of the rotated width is larger than the supported resolution size.
	Enlarges the photo by 100 %, 200 % or 400 %.
	Adjusts the brightness of the screen for energy saving.
Option	To display the OPTIONS .
Hide	Hides the option window.
Exit	Return to Photo List .

Photo options

- 1 Press **SETTINGS** to show the **Option** menus.
- 2 Press the navigation buttons to scroll to **Set Photo View**, **Set Video**, or **Set Audio**, and press **OK**.

NOTE

- The option values changed in **Movie List** do not affect **Photo List** or **Music List**. Therefore, they are not affected by option values changed in **Photo List** or **Music List**.
- The option values changed in **Photo List** and **Music List** do affect each other.









Select **Setting Photo View** to access the following menus:

Menu	Description
Slide Speed	Select a slideshow speed. (Options: Fast, Medium, or Slow.)
BGM	Selects a music folder for the background music.
Repeat	Plays background music on repeat.
Random	Plays background music in random order.

Listening to Music

Plays music files saved in the USB storage device.









- 1 Press **SETTINGS** to access the main menu.
- 2 Press the navigation button to scroll to **MY MEDIA** and press **OK**.
- 3 Press the navigation button to scroll to **Music List** and press **OK**.
- 4 Press the navigation buttons to scroll to a folder you want and press **OK**.
- 5 Press the navigation buttons to scroll to a file you want and press **OK**.
 - **Change Device** : Selects the USB storage device. (Depending on model)
 - **Go to root folder** : Returns to the home screen of My Media.
 - **Open Music Player** : Opens the settings window for music. This feature is activated only during playback.
 - **Go to upper folder** : Returns to the previous screen.
 - **Exit** : Exits My Media.
- 6 During music playback, press **OK** to access the following settings.

Remote button	Description
	Stops playing back the file and moves back to the Music List .
	Plays a music file.
	Pauses or resumes playback.
	Skips to the previous file.
	Skips to the next file.
	Adjusts the brightness of the screen for energy saving (Off and Screen Off work only.)
SETTINGS	Show the Option menu.
 BACK	Hides the option window.
EXIT	Return to Music List .
	Skips to specific points in a file during playback. The time of a specific point will appear on the status bar. In some files, this function may not work properly.

Tips for playing music files

- This unit cannot support the ID3 Tag embedded MP3 files.

NOTE

- A damaged or corrupted music file does not play but displays 00:00 in playtime.
- A music downloaded from a paid service with copyright protection does not start but displays inappropriate information in playtime.
- If you press **OK**,  buttons, screen saver is stopped.
- The , , , ,  buttons on the remote control are also available in this mode.
- You can use the  button to select the next music and the  button to select the previous music.

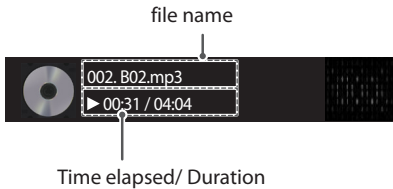

Music options

- 1 Press **SETTINGS** to access the pop-up menus.
- 2 Press the navigation buttons to scroll to **Set Audio Play** or **Set Audio** and press **OK**.

NOTE

- The option values changed in **Movie List** do not affect **Photo List** or **Music List**. Therefore, they are not affected by option values changed in **Photo List** or **Music List**.
- The option values changed in **Photo List** and **Music List** do affect each other.

When you select the **Set Audio Play**,

Menu	Description
Repeat	Repeats the music playback.
Random	Plays random music tracks.

Viewing the Contents List

Plays back the stored files using the **Export** option in **SuperSign Manager**.

- 1 Press **SETTINGS** to access the main menu.
 - 2 Press the navigation button to scroll to **MY MEDIA** and press **OK**.
 - 3 Press the navigation button to scroll to **Contents List** and press **OK**.
 - 4 Press the navigation buttons to scroll to a folder you want and press **OK**.
 - 5 Press the navigation buttons to scroll to a file you want and press **OK**.
- **Change Device** : Selects the USB storage device. (Depending on model)
 - **Go to root folder** : Returns to the home screen of My Media.
 - **Go to upper folder** : Returns to the previous screen.
 - **Exit** : Exits My Media.

NOTE

- While playing media files from **Contents List**, only the **BACK, EXIT**, or volume button are available. Selecting the **BACK** or **EXIT** button stops playing media files and returns to the **Contents List**.
- When you use the distribution feature which utilizes SuperSign Software, the storage device used to store contents is determined based on the size of the remaining memory space. (Note: If USB ports 1 and 2 have the same memory space, contents will be saved on the storage device connected to USB port 1.(Depending on model))
- If there is the AutoPlay folder in the USB device and its files are in supported formats, they can be played back automatically when the USB device is connected to the monitor.
- It is recommended that you avoid playing contents using more than two USB ports simultaneously.
- With respect to the playback of distribution or contents schedules through SuperSign Software, the schedule executed last time is played.

Supported Video Codec

Extension	Codec	
.asf .wmv	Videos	VC-1 Simple and Main Profiles
	Audio	WMA Standard, WMA 10 Professional
.divx .avi	Videos	DivX3.11, DivX4, DivX5, DivX6, XVID, H.264/AVC, Motion Jpeg, MPEG-4 Part2
	Audio	MPEG-1 Layer I, II, MPEG-1 Layer III (MP3), Dolby Digital, LPCM, ADPCM, DTS
.mp4 .m4v .mov	Videos	H.264/AVC, MPEG-4 Part2
	Audio	AAC, MPEG-1 Layer III (MP3)
.3gp .3g2	Videos	H.264/AVC, MPEG-4 Part2
	Audio	AAC, AMR-NB, AMR-WB
.mkv	Videos	H.264/AVC
	Audio	HE-AAC, Dolby Digital
.ts .trp .tp .mts .m2ts	Videos	H.264/AVC, MPEG-2
	Audio	MPEG-1 Layer I, II, MPEG-1 Layer III (MP3), Dolby Digital, Dolby Digital Plus, AAC, PCM
.mpg .mpeg	Videos	MPEG-1, MPEG-2
	Audio	MPEG-1 Layer I, II, MPEG-1 Layer III (MP3), AAC
.vob	Videos	MPEG-1, MPEG-2
	Audio	Dolby Digital, MPEG-1 Layer I, II, DVD-LPCM

Tips for Playing Video Files

- A damaged movie file may not play correctly, or some player features may not be usable.
- Movie files produced with some encoders may not be played correctly.
- Movie files other than the specified types and formats may not work properly.
- Max bit rate of playable movie file is 20 Mbps. (For Motion JPEG: 10 Mbps only)
- We do not guarantee smooth playback of profiles encoded level 4.1 or higher in H.264 / AVC.
- Video files larger than 50 MB may not upload properly from mobile devices. We recommend that you play such files via USB/SD storage devices.
- [For Ultra HD models only] Ultra HD image: 3840 X 2160
Some HEVC-encoded Ultra HD videos other than the content officially provided by LG Electronics may not be played.

Extension	Codec	
.mkv .mp4 .ts	Video	H.264/AVC, HEVC
	Audio	Dolby Digital, Dolby Digital Plus, AAC, HE-AAC

- Some codecs can be used after upgrading software.

CUSTOMIZING SETTINGS

Accessing Main Menus

- 1 Press **SETTINGS** to access the main menus.
 - 2 Press the navigation buttons to scroll to one of the following menus and press **OK**.
 - 3 Press the navigation buttons to scroll to the setting or option you want and press **OK**.
 - 4 When you are finished, press **EXIT**. When you return to the previous menu, press **BACK**.
- **PICTURE** : Adjusts the image size, quality, or effect.
 - **AUDIO** : Adjusts the sound quality, effect, or volume level.
 - **TIME** : Sets the time, date, or timer feature.
 - **OPTION** : Customizes the general settings.
 - **NETWORK** : Sets up the network setting.
 - **MY MEDIA** : Display and play movie, photo and music contents stored on your USB or signage device (Internal storage device).

PICTURE Settings

- 1 Press **SETTINGS** to access the main menus.
- 2 Press the navigation buttons to scroll to **PICTURE** and press **OK**.
- 3 Press the navigation buttons to scroll to the setting or option you want and press **OK**.
- To return to the previous level, press **BACK**.
- 4 When you are finished, press **EXIT**.
When you return to the previous menu, press **BACK**.

The available picture settings are described in the following:

Setting	Description	
Energy Saving	Reduces power consumption by adjusting peak screen brightness.	
	Level	
	Off	Disables Energy Saving function.
	Minimum/ Medium/ Maximum	Selects the brightness level of the backlight.
	Screen Off	The screen turns off in 3 seconds.
Smart Energy Saving	Adjusts the backlight and contrast depending on the screen brightness.	
	Level	
	Off	Disables the Smart Energy Saving function.
	On	Enables the Smart Energy Saving function to save power consumption as much as the value set in the smart energy saving rate.
Picture Mode	Selects the picture mode optimized for the viewing environment or the programme.	
	Mode	
	Vivid	Heightens contrast, brightness, and sharpness to display vivid images.
	Standard	Displays images in standard levels of contrast, brightness, and sharpness.
	APS	APS (Auto power saving) mode reduces power consumption by dimming control.
	Cinema	Optimizes the video image for a cinematic look to enjoy movies as if you are in a movie theater.
	Sport	Optimizes the video image for high and dynamic actions by emphasizing primary Colors such as white, grass, or sky blue.
	Game	Optimizes the video image for a fast gaming screen such as PCs or games.
	Calibration	Applies user-customized white balance based on Standard.
Expert1-2	Menu for adjusting picture quality that allows experts and amateurs to enjoy the best Monitor viewing.	
Aspect Ratio	Changes the image size to view images at its optimal size.	

Setting	Description
Screen (In RGB Mode Only)	Customizes the PC display options in RGB mode.
	Option
	Resolution Selects a proper resolution.
	Auto Configure Sets to adjust the screen position, clock, and phase automatically. The displayed image may be unstable for a few seconds while the configuration is in progress.
	Position/Size/Phase Adjusts the options when the picture is not clear, especially when characters are shaky, after the auto configuration.
Reset	Restores the options to the default setting.

Basic image options

Setting	Description
Backlight	Adjusts the brightness of the screen by controlling the LCD backlight. If you decrease the brightness level, the screen becomes darker and the power consumption will be reduced without any video signal loss.
Contrast	Increases or decreases the gradient of the video signal. You may use Contrast when the bright part of the picture is saturated.
Brightness	Adjusts the base level of the signal in the picture. You may use Brightness when the dark part of the picture is saturated.
Sharpness	Adjusts the level of crispness in the edges between the light and dark areas of the picture. The lower the level, the softer the image.
Color	Adjusts intensity of all colors.
Tint	Adjusts the balance between red and green levels.
Color Temp.	Set to warm to enhance hotter Colors such as red, or set to cool to make picture bluish.
Advanced Control/Expert Control	You can adjust the picture for each Picture Mode , or adjust the picture settings according to a specific picture image. First, select a desired Picture Mode . * This option is unavailable if Picture Mode is set to Vivid .
Picture Option	Sets additional picture option.
Picture Reset	Restores the options to the default setting.

! NOTE

- When you select a picture mode, related menus are set automatically.
- When using the Smart Energy Saving function, the screen may look saturated in the white area of a still image.
- If Energy Saving is set to Minimum, Medium, or Maximum, the Smart Energy Saving function is disabled.

Advanced Control - Picture Mode (Standard/ APS/ Sport/ Game/ Calibration)

Setting	Description
Dynamic Contrast	Adjusts the contrast to the optimal level according to the brightness of the image.
Dynamic Color	Adjusts color for more natural-looking colors.
Color Gamut	Selects the range of colours that can be expressed.
Skin Color	Skin color spectrum can be separately set to implement the skin color as defined by the user.
Sky Color	Sky color is set separately.
Grass Color	Natural color spectrum (meadows, hills, etc.) can be separately set.
Gamma	Sets the gradation curve according to the output of the picture signal in relation to the input signal.

Expert Control - Picture Mode (Cinema/ Expert1/ Expert2)

Setting	Description
Dynamic Contrast	Adjusts the contrast to the optimal level according to the brightness of the image. (Function works in the following mode - HDMI-DTV)
Color Gamut	Selects the range of colours that can be expressed.
Edge Enhancer	Shows clearer and distinctive yet natural edges of the video.
Color Filter	Filters a specific colour spectrum in RGB colours to fine-tune colour saturation and hue accurately.
Color Temperature	Adjusts the overall tone of the screen as desired. In Expert mode, detailed fine-tuning can be set via Gamma method, etc.
Color Management System	This is a system that experts use when they adjust colour with a test pattern. They can select from six colour areas (Red / Green / Blue / Cyan / Magenta / Yellow) without affecting other colours. For normal images, adjustments may not result in noticeable colour changes.

Picture Option - HDMI(DTV) Mode

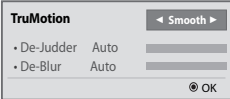
Setting	Description
Noise Reduction	Reduces screen noise in the video.
MPEG Noise Reduction	Reduces noise caused by compressing digital video.
Black Level	Adjusts the brightness or darkness of the screen to suit the black level of the picture input using the degree of darkness (black level) of the screen.
Real Cinema	Optimizes the screen for movie viewing.
TruMotion (This feature is supported by 65SE3B and 65SE3KB only.)	<p>Corrects images to display smoother motion sequences.</p> <ul style="list-style-type: none"> • Off : Turn off the TruMotion. • Smooth/ Clear : De-Judder / De-Blur can be set Auto. • User : De-Judder / De-Blur can be set manually. <ul style="list-style-type: none"> - De-Judder : This function adjusts juddering of the screen. - De-Blur : This function adjusts and eliminates blurring of the screen. 

AUDIO Settings

- 1 Press **SETTINGS** to access the main menus.
- 2 Press the navigation buttons to scroll to **AUDIO** and press **OK**.
- 3 Press the navigation buttons to scroll to the setting or option you want and press **OK**.
- To return to the previous level, press **BACK**.
- 4 When you are finished, press **EXIT**.
When you return to the previous menu, press **BACK**.

The available audio options are described in the following:

Setting	Description	
Sound Mode	Allows optimized sound for custom Monitor installation.	
	Level	
	Standard	Suitable for all types of video.
	News/ Music/ Cinema/ Sport/ Game	Sets audio optimized for a specific genre.
Sound Effect	The user can select various sound effects. - Sound Effect function is available only for Standard mode in Sound Mode menu.	
	Level	
	Clear Voice II	Boosts voice clarity.
	Virtual Surround	LG's proprietary audio processing technology allows 5.1ch-like surround sound from two speakers. - If Clear Voice II is set to On , Virtual Surround will not be chosen.
	Equalizer	Adjusts the volume to a level of your choice using the Equalizer.
	Balance	Adjusts left/right audio balance.
	Reset	You can reset the settings under the Sound Effects menu.
AV Sync. Adjust	Synchronizes video and audio directly when they do not match. If you set AV Sync. to ON , you can adjust the sound output to the screen image. <ul style="list-style-type: none"> • Speaker: Adjusts the synchronization of the sound from the speakers. The "-" button makes the sound output faster and the "+" button slower than the default value. • Bypass: The audio of an external device without audio delay. Audio may be output before video as it takes time to process video input into the Monitor. 	

NOTE

- Some models may not have built-in speakers. In that case, you need to connect external speakers to listen to sound.

TIME Settings

- 1 Press **SETTINGS** to access the main menus.
- 2 Press the navigation buttons to scroll to **TIME** and press **OK**.
- 3 Press the navigation buttons to scroll to the setting or option you want and press **OK**.
- To return to the previous level, press **BACK**.
- 4 When you are finished, press **EXIT**.
When you return to the previous menu, press **BACK**.

The available time settings are described in the following:

Setting	Description	
Clock	Sets the time feature.	
	Level	
	Auto	The current time is entered according to the selected country when connected to a network.
	Manual	The current time needs to be entered manually.
On/Off Time	Sets the time to turn on or off the monitor set.	
Auto Off (15Min.)	If Auto-off is active and there is no input signal, the set switches to off mode automatically after 15 minutes.	
Automatic Standby	If the monitor is left unattended for a set period of time, it automatically goes into standby mode.	

NOTE

- Off Time/ On Time can be saved for up to seven schedules; the monitor is turned on or off at the preset time in the schedule list. If multiple preset times are stored in the schedule list, this function works at the nearest time from the current time.
- Once the on or off time is set, these functions operate daily at the preset time.
- When the scheduled power-on and power-off times are the same, the power-off time has priority over the power-on time if the set is turned on, and vice versa if the set is turned off.
- If port 123 is blocked by a firewall, your monitor cannot receive the current time from the network.

OPTION Settings

- 1 Press **SETTINGS** to access the main menus.
- 2 Press the navigation buttons to scroll to **OPTION** and press **OK**.
- 3 Press the navigation buttons to scroll to the setting or option you want and press **OK**.
- To return to the previous level, press **BACK**.
- 4 When you are finished, press **EXIT**.
When you return to the previous menu, press **BACK**.

The available option settings are described in the following:

Setting	Description	
Language	Selects a language for the display text.	
Country	Select your country.	
DivX(R) VOD	Registers or releases DivX. Checks DivX Registration Code for playing DivX-protected videos. Register at http://vod.divx.com . Uses Registration Code to rent or purchase movies at www.divx.com/vod . * Rented/purchased DivX files cannot be played if the DivX Registration Code of a different device is used. Use only the DivX Registration Code granted to this device. * Converted files not conforming to the DivX Codec Standard may not play or may produce abnormal images.	
Initial Setting	Deletes all optional settings and returns to initial default mode.	
Set ID	You can assign a unique Set ID NO (name assignment) to each product when several products are connected for display. Specify the number (1 to 255 or 1 to 1,000) using the button and exit. Use the assigned Set ID to individually control each product using the Product Control Program.	
Tile Mode	Tile Mode	To use this function - Must be displayed with various other products. - Select Tile Mode, set rows and columns, and then enter the tile ID to set the location. - Tile Mode: row x column (row = 1-15, column = 1-15). - 15 x 15 available.
	Auto Config.	Sets to adjust the screen position, clock, and phase automatically. The displayed image may be unstable for a few seconds while the configuration is in progress.
	Position	Moving the screen position horizontally and vertically.
	Size	Adjust the horizontal and vertical size of the screen taking into account the size of the bezel.
	Natural	The image is omitted by the distance between the screens to be naturally shown.
	Reset	Function to initialize and release Tile. All Tile setting are released when selecting Tile recall and the screen returns to Full screen.

SETTINGS	Description
Contents Schedule	Creates simple schedules and sets playback using files in My Media.
	Level
	Add Schedule Creates a contents schedule. - Media: Select the file to which you want to apply the contents schedule. - Select [Create] to register the contents schedule.
	Play Plays a contents schedule.
	Delete All Deletes all registered schedules.
	<div data-bbox="281 443 404 491">  NOTE </div> <ul data-bbox="303 502 1011 874" style="list-style-type: none"> • Information about registered schedules is stored on your USB storage device. This feature does not work when your USB storage device has been removed. • The picture size is 1920 x 1080. • You can use photo and video files only. • You can add up to 50 files (photo files + video files = 50). • Only photos whose resolution is 1920 x 1080 or below are supported. • The default display time for photos is 1 minute. Playback time for movies differs depending on the running time. • You can create up to 7 schedules. • You cannot register a schedule when no file has been selected. • Contents schedules that have had information forcibly modified using a PC, etc. may not function properly. • With respect to the playback of distribution or contents schedules through SuperSign Software, the schedule executed last time is played.

Tile Mode

This monitor can be tiled with additional monitors to create a large tiled display.

Off

When the Tile Mode option is disabled

1X2

When using 2 monitors

**2X2**

When using 4 monitors

**3X3**

When using 9 monitors

**4X4**

When using 16 monitors

**5X5**

When using 25 monitors

**Tile Mode - Natural mode**

When active, the part of the image that would normally be displayed in the gap between the monitors is omitted.

Before



After



NETWORK Settings

- 1 Press **SETTINGS** to access the main menus.
- 2 Press the navigation buttons to scroll to **NETWORK** and press **OK**.
- 3 Press the navigation buttons to scroll to the setting or option you want and press **OK**.
- To return to the previous level, press **BACK**.
- 4 When you are finished, press **EXIT**.
When you return to the previous menu, press **BACK**.

The available option settings are described in the following:

Setting	Description
Network Setting	Configure the network settings.
	Network setting When the Wi-Fi dongle is connected, you can view and connect to any available wireless network.
Network Status	Display the network status.

Network Connection Options

Setting	Description
Setting from the AP list	Select an AP to connect to a wireless network.
Simple setting (WPS-button mode)	Press the button on the wireless router that supports PBC to easily connect to the router.

PICTURE ID Settings

- Only applies to certain models.

PICTURE ID is used to change the settings of a specific set (display) using a single IR receiver for multi-vision. Communication is possible between a monitor with an IR receiver and other monitors using RS-232C cables. Each monitor is identified by a **Set ID**. If you assign the **PICTURE ID** using the remote control, only displays with matching **PICTURE ID** and **Set ID** can be controlled remotely.

- 1 Assign the **Set ID** to the installed monitors as shown below.

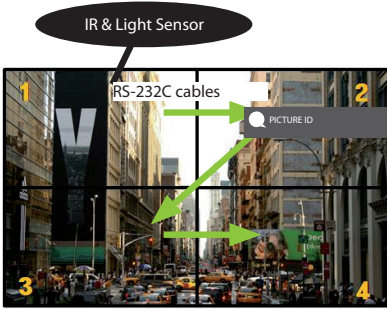

- 2 Press the red **ON** button on the remote control to assign the **PICTURE ID**.
- 3 Assign the **Set ID** to the selection of your choice.
 - A set with a different **Set ID** from the **PICTURE ID** cannot be controlled by IR signals.

! NOTE

- If **PICTURE ID** is set to 2, only the upper right monitor, which has a **Set ID** of 2, can be controlled by IR signals.
- If you press the green **OFF** button for **PICTURE ID**, the **PICTURE IDs** for all monitors are turned off. If you then press any button on the remote control, all monitors can be controlled by IR signals regardless of **Set ID**.

IR CODES

- All models do not support the HDMI/USB function.
- Some key codes are not supported depending on the model.

Code (Hexa)	Function	Note
08	 (Power)	R/C BUTTON
0B	INPUT	R/C BUTTON
C4	MONITOR ON	R/C BUTTON
C5	MONITOR OFF	R/C BUTTON
95	ENERGY SAVING 	R/C BUTTON
DC	3D	R/C BUTTON
10 to 19	Number Key 0 to 9	R/C BUTTON
53	1/a/A	R/C BUTTON
2F	CLEAR	R/C BUTTON
02	Volume  (+)	R/C BUTTON
03	Volume  (-)	R/C BUTTON
79	ARC	R/C BUTTON
99	AUTO	R/C BUTTON
09	MUTE	R/C BUTTON
E0	BRIGHTNESS  (Page UP)	R/C BUTTON
E1	BRIGHTNESS  (Page Down)	R/C BUTTON
4D	PSM	R/C BUTTON
AA	INFO 	R/C BUTTON
5F	W.BAL	R/C BUTTON
43	SETTINGS	R/C BUTTON
40	Up 	R/C BUTTON
41	Down 	R/C BUTTON
07	Left 	R/C BUTTON
06	Right 	R/C BUTTON
3F	S.MENU	R/C BUTTON
44	OK	R/C BUTTON
28	BACK	R/C BUTTON
5B	EXIT	R/C BUTTON
7E	 SIMPLINK	R/C BUTTON
7B	TILE (Tile Mode)	R/C BUTTON
B1		R/C BUTTON
B0		R/C BUTTON
BA		R/C BUTTON

Code (Hexa)	Function	Note
8F	◀	R/C BUTTON
8E	▶	R/C BUTTON
72	Red Key (PICTURE ID ON)	R/C BUTTON
71	Green Key (PICTURE ID OFF)	R/C BUTTON
63	Yellow Key	R/C BUTTON
61	Blue Key	R/C BUTTON

TO CONTROL MULTIPLE PRODUCTS

- Use this method to connect several products to a single PC. You can control several products at a time by connecting them to a single PC.
- In the Option menu, Set ID must be between 1 and 255 (or from 1 to 1,000) without being duplicated.

Connecting the Cable

Connect the RS-232C cable as shown in the picture.

- The RS-232C protocol is used for communication between the PC and product. You can turn the product on or off, select an input source or adjust the OSD menu from your PC.

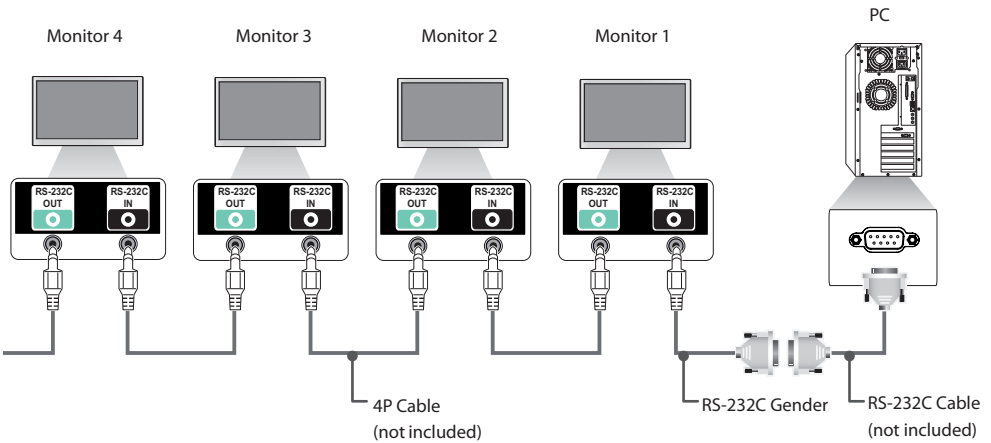

RS-232C Configurations

4P Cable

4-Wire Configurations (Standard RS-232C cable)



NOTE

- When using three-wire connections (non-standard), an IR daisy chain cannot be used.
- If you want to control multiple units simultaneously, use 3.5 mm 4-pole cables (sold separately).

RS-232C Cable

8-Wire Configurations (Standard RS-232C cable)

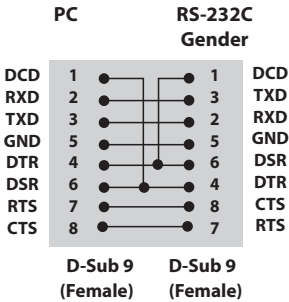

Communication Parameter

- **Baud Rate** : 9600 BPS
- **Data Length** : 8 bit
- **Parity Bit** : None
- **Stop Bit** : 1 bit
- **Flow Control** : None
- **Communication Code** : ASCII code
- Use a crossed (reverse) cable

Command Reference List

		COMMAND		DATA (Hexadecimal)
		1	2	
01	Power	k	a	00 to 01
02	Select input	x	b	See [Select input]
03	Aspect ratio	k	c	See [Aspect ratio]
04	Energy saving	j	q	See [Energy saving]
05	Picture mode	d	x	See [Picture mode]
06	Contrast	k	g	00 to 64
07	Brightness	k	h	00 to 64
08	Sharpness	k	k	00 to 32
09	Color	k	i	00 to 64
10	Tint	k	j	00 to 64
11	Color temperature	x	u	00 to 64
12	H position	f	q	00 to 64
13	V position	f	r	00 to 64
14	H size	f	s	00 to 64
15	Auto Config.	j	u	01
16	Balance	k	t	00 to 64
17	Sound Mode	d	y	See [Sound mode]
18	Mute	k	e	00 to 01
19	Volume	k	f	00 to 64
20	Clock 1 (year/month/day)	f	a	See [Clock 1]
21	Clock 2 (hour/minute/second)	f	x	See [Clock 2]
22	Off time schedule	f	c	00 to 01
23	On time schedule	f	b	00 to 01
24	Off timer (repeat mode/time)	f	e	See [Off timer]
25	On timer (repeat mode/time)	f	d	See [On timer]
26	On timer input	f	u	See [On timer input]
27	Automatic Standby	m	n	00 to 01
28	Auto off	f	g	00 to 01
29	Language	f	i	See [Language]
30	Reset	f	k	00 to 02
31	Current temperature	d	n	FF
32	Key	m	c	See [Key]
33	Time elapsed	d	l	FF
34	Product serial number	f	y	FF

		COMMAND		DATA (Hexadecimal)
		1	2	
35	Software version	f	z	FF
36	White balance red gain	j	m	00 to FE
37	White balance green gain	j	n	00 to FE
38	White balance blue gain	j	o	00 to FE
39	Backlight	m	g	00 to 64
40	Screen off	k	d	00 to 01
41	Tile Mode	d	d	See [Tile Mode]
42	Tile Mode Check	d	z	FF
43	Tile ID	d	i	Refer to 'Tile ID'.
44	Tile H Position	d	e	00 to 32
45	Tile V Position	d	f	00 to 32
46	Tile H Size	d	g	00 to 32
47	Tile V Size	d	h	00 to 32
48	Natural Mode (In Tile mode)	d	j	00 to 01

 **NOTE**

- During USB operations such as Dvix or EMF, all commands except Power (k a) and Key (m c) are not executed and treated as NG.
- Some commands are not supported depending on the model.
- The 'f f' command which shows the status of a certain command does not display the OSD as the result in order to be compatible with SuperSign program.

Transmission / Receiving Protocol

Transmission

[Command1][Command2][][Set ID][][Data][Cr]

- * [Command1] Identifies the factory setting and the user setting modes.
- * [Command2] Controls monitors.
- * [Set ID] Used for selecting a set you want to control. A Set ID can be assigned to each set from 1 to 255 (from 01H to FFH), or from 1 to 1,000 (from 001H to 3e8H) in certain models, under OPTION in the OSD menu. Selecting '00H' or '000H' for Set ID allows the simultaneous control of all connected monitors. (It may not be supported depending on the model.)
- * [Data] Transmits command data.
Data count may increase depending on the command.
- * [Cr] Carriage Return. Corresponds to '0x0D' in ASCII code.
- * [] White Space. Corresponds to '0x20' in ASCII code.

Acknowledgement

[Command2][][Set ID][][OK/NG][Data][x]

- * The Product transmits an ACK (acknowledgement) based on this format when receiving normal data. At this time, if the data is FF, it indicates the present status data. If the data is in data write mode, it returns the data of the PC computer.
- * If a command is sent with Set ID '00' (=0x00) or '000' (=0x000), the data is reflected to all monitor sets and they do send any acknowledgement (ACK).
- * If the data value 'FF' is sent in control mode via RS-232C, the current setting value of a function can be checked (only for some functions).
- * Some commands may not be supported on some models.

01. Power (Command: k a)

Controls the power on/off of the set.

Transmission`[k][a][][Set ID][][Data][Cr]`

Data	00: Off
	01: On

Acknowledgement`[a][][Set ID][][OK/NG][Data][x]`

* Only when the monitor is fully powered on, the acknowledgement signal is returned properly.

* There may be a delay between the transmission and acknowledgement signals.

02. Select input (Command: x b)

Selects an input signal.

Transmission`[x][b][][Set ID][][Data][Cr]`

Data	60: RGB
	70: DVI-D (PC)
	80: DVI-D (DTV)
	90: HDMI (HDMI1) (DTV)
	91: OPS (DTV)
	A0: HDMI (HDMI1) (PC)
	A1: OPS (PC)
	C0: DISPLAYPORT (DTV)
	D0: DISPLAYPORT (PC)

Acknowledgement`[b][][Set ID][][OK/NG][Data][x]`

* Some input signals may not be supported on some models.

03. Aspect ratio (Command: k c)

Adjusts the aspect ratio.

Transmission`[k][c][][Set ID][][Data][Cr]`

Data	01: 4:3
	02: 16:9
	04: Zoom (HDMI)(DTV)
	06: Auto ratio (HDMI)(DTV)
	09: Original (≥ 720p) (HDMI) (DTV)
	10 to 1F: Cinema zoom 1 to 16 (HDMI) (DTV)

* Available data types differ depending on the input signal. For more information, see the aspect ratio section of the owner's manual.

* The aspect ratio may differ depending on the model's input configuration.

Acknowledgement`[c][][Set ID][][OK/NG][Data][x]`**04. Energy saving (Command: j q)**

Sets the energy saving function.

Transmission`[j][q][][Set ID][][Data][Cr]`

Data	00: Off
	01: Minimum
	02: Medium
	03: Maximum
	04: Automatic
	05: Screen off

Acknowledgement`[q][][Set ID][][OK/NG][Data][x]`

** This may not be supported on some models.

05. Picture mode (Command: d x)

Selects a picture mode.

Transmission`[d][x][][Set ID][][Data][Cr]`

Data	00: Vivid
	01: Standard
	02: Cinema
	03: Sport
	04: Game
	05: Expert 1
	06: Expert 2
	08: Eco
	11: Calibration

Acknowledgement`[x][][Set ID][][OK/NG][Data][x]`**06. Contrast (Command: k g)**

Adjusts the screen contrast.

Transmission`[k][g][][Set ID][][Data][Cr]`

Data	00 to 64: Contrast 0 to 100
------	-----------------------------

Acknowledgement`[g][][Set ID][][OK/NG][Data][x]`

07. Brightness (Command: k h)

Adjusts the screen brightness.

Transmission

[k][h][][Set ID][][Data][Cr]

Data 00 to 64: Brightness 0 to 100

Acknowledgement

[h][][Set ID][][OK/NG][Data][x]

08. Sharpness (Command: k k)

Adjusts the screen sharpness.

Transmission

[k][k][][Set ID][][Data][Cr]

Data 00 to 32: Sharpness 0 to 50

Acknowledgement

[k][][Set ID][][OK/NG][Data][x]

09. Color (Command: k i)

Adjusts the screen color.

Transmission

[k][i][][Set ID][][Data][Cr]

Data 00 to 64: Color 0 to 100

Acknowledgement

[i][][Set ID][][OK/NG][Data][x]

10. Tint (Command: k j)

Adjusts the screen tint.

Transmission

[k][j][][Set ID][][Data][Cr]

Data 00 to 64: Tint red 50 to green 50

Acknowledgement

[j][][Set ID][][OK/NG][Data][x]

11. Color temperature (Command: x u)

Adjusts the screen color temperature.

Transmission

[x][u][][Set ID][][Data][Cr]

Data 00 to 64: Warm 50 to cool 50

Acknowledgement

[u][][Set ID][][OK/NG][Data][x]

12. H position (Command: f q)

Adjusts the horizontal position of the screen.

This function is only available when the Tile Mode is set to Off.

* The operational range varies depending on the RGB input resolution.

(Only available in RGB-PC input mode)

Transmission

[f][q][][Set ID][][Data][Cr]

Data 00 to 64: Min -50 (left) to max 50 (right)

Acknowledgement

[q][][Set ID][][OK/NG][Data][x]

13. V position (Command: f r)

Adjusts the vertical position of the screen.

This function is only available when the Tile Mode is set to Off.

* The operational range varies depending on the RGB input resolution.

(Only available in RGB-PC input mode)

Transmission

[f][r][][Set ID][][Data][Cr]

Data 00 to 64: Min -50 (down) to max 50 (up)

Acknowledgement

[r][][Set ID][][OK/NG][Data][x]

14. H size (Command: f s)

Adjusts the horizontal size of the screen.

This function is only available when the Tile Mode is set to Off.

* The operational range varies depending on the RGB input resolution.

(Only available in RGB-PC input mode)

Transmission

[f][s][][Set ID][][Data][Cr]

Data 00 to 64: Min -50 (small) to max 50 (large)

Acknowledgement

[s][][Set ID][][OK/NG][Data][x]

15. Auto Config. (Command: j u)

Automatically corrects position and shaking of the picture.

(Only available in RGB-PC input mode)

Transmission

[j][u][][Set ID][][Data][Cr]

Data 01: Execution

Acknowledgement

[u][][Set ID][][OK/NG][Data][x]

16. Balance (Command: k t)

Adjusts the sound balance.

Transmission

[k][t][][Set ID][][Data][Cr]

Data 00 to 64: Left 50 to right 50

Acknowledgement

[t][][Set ID][][OK/NG][Data][x]

17. Sound mode (Command: d y)

Selects a sound mode.

Transmission

[d][y][][Set ID][][Data][Cr]

Data 01: Standard
02: Music
03: Cinema
04: Sport
05: Game
07: News

Acknowledgement

[y][][Set ID][][OK/NG][Data][x]

18. Mute (Command: k e)

Mutes/unmutes the sound.

Transmission

[k][e][][Set ID][][Data][Cr]

Data 00: Mute
01: Unmute

Acknowledgement

[e][][Set ID][][OK/NG][Data][x]

19. Volume (Command: k f)

Adjusts the playback volume.

Transmission`[k][f][][Set ID][][Data][Cr]`

Data 00 to 64: Volume 0 to 100

Acknowledgement`[f][][Set ID][][OK/NG][Data][x]`**22. Off time schedule (Command: f c)**

Enables/disables the on time schedule.

Transmission`[f][c][][Set ID][][Data][Cr]`Data 00: Off
01: On**Acknowledgement**`[c][][Set ID][][OK/NG][Data][x]`**20. Clock 1 (year/month/day) (Command: f a)**

Adjusts the Clock 1 (year/month/day) value.

Transmission`[f][a][][Set ID][][Data1][][Data2][][Data3][Cr]`Data1 00 to 14: Year 2010 to 2040
Data2 01 to 0C: January to December
Data3 01 to 1F: 1st to 31st

* Enter "fa [Set ID] ff" to view the Clock 1 (year/month/day) settings.

Acknowledgement`[a][][Set ID][][OK/NG][Data1][Data2][Data3][x]`**23. On time schedule (Command: f b)**

Enables/disables the on time schedule.

Transmission`[f][b][][Set ID][][Data][Cr]`Data 00: Off
01: On**Acknowledgement**`[b][][Set ID][][OK/NG][Data][x]`**21. Clock 2 (hour/minute/second) (Command: f x)**

Adjusts the Clock 2 (hour/minute/second) value.

Transmission`[f][x][][Set ID][][Data1][][Data2][][Data3][Cr]`Data1 00 to 17: 00 to 23 hours
Data2 00 to 3B: 00 to 59 minutes
Data3 00 to 3B: 00 to 59 seconds

* Enter "fx [Set ID] ff" to view the Clock 2 (hour/minute/second) settings.

** This function is only available when Clock 1 (year/month/day) is set.

Acknowledgement`[x][][Set ID][][OK/NG][Data1][Data2][Data3][x]`

24. Off timer (repeat mode/time) (Command: f e)

Configures the off time (repeat mode/time) settings.

Transmission`[f][e][][Set ID][][Data1][][Data2][][Data3][Cr]`

Data1

1. F1 to F7 (reading data)

F1: Read the 1st off timer data

F2: Read the 2nd off timer data

F3: Read the 3rd off timer data

F4: Read the 4th off timer data

F5: Read the 5th off timer data

F6: Read the 6th off timer data

F7: Read the 7th off timer data

2. E1 to E7 (deleting one index), E0 (deleting all indexes)

E0: Erase all off timer setting

E1: Erase the 1st off timer setting

E2: Erase the 2nd off timer setting

E3: Erase the 3rd off timer setting

E4: Erase the 4th off timer setting

E5: Erase the 5th off timer setting

E6: Erase the 6th off timer setting

E7: Erase the 7th off timer setting

3. 01 to 0C (setting the day of the week for off timer)

01: Once

02: Daily

03: Mon - Fri

04: Mon - Sat

05: Sat - Sun

06: Every Sunday

07: Every Monday

08: Every Tuesday

09: Every Wednesday

0A: Every Thursday

0B: Every Friday

0C: Every Saturday

Data2 00 to 17: 00 to 23 hours

Data3 00 to 3B: 00 to 59 minutes

* To read or delete the Off Time list, set FFH for [Data2] and [Data3].

Example 1: fe 01 f1 ffff - Read the 1st index data from off timer.

Example 2: fe 01 e1 ffff - Delete the 1st index data from off timer.

Example 3: fe 01 04 02 03 - Sets Off Timer to 02:03 for Monday-Saturday.

* This function is only available when Clock 1 (year/month/day) and Clock 2 (hour/minute/second) are set.

Acknowledgement`[e][][Set ID][][OK/NG][Data1][Data2][Data3][x]`**25. On timer (repeat mode/time) (Command: f d)**

Configures the on time (repeat mode/time) settings.

Transmission`[f][d][][Set ID][][Data1][][Data2][][Data3][Cr]`

Data1

1. F1 to F7 (reading data)

F1: Read the 1st on timer data

F2: Read the 2nd on timer data

F3: Read the 3rd on timer data

F4: Read the 4th on timer data

F5: Read the 5th on timer data

F6: Read the 6th on timer data

F7: Read the 7th on timer data

2. E1 to E7 (deleting one index), E0 (deleting all indexes)

E0: Erase all on timer setting

E1: Erase the 1st on timer setting

E2: Erase the 2nd on timer setting

E3: Erase the 3rd on timer setting

E4: Erase the 4th on timer setting

E5: Erase the 5th on timer setting

E6: Erase the 6th on timer setting

E7: Erase the 7th on timer setting

3. 01 to 0C (setting the day of the week for the on timer)

01: Once

02: Daily

03: Mon - Fri

04: Mon - Sat

05: Sat - Sun

06: Every Sunday

07: Every Monday

08: Every Tuesday

09: Every Wednesday

0A: Every Thursday

0B: Every Friday

0C: Every Saturday

Data2 00 to 17: 00 to 23 hours

Data3 00 to 3B: 00 to 59 minutes

* To read or delete an on timer list you have set, [Data2][Data3] must be set to FFH.

Example 1: fd 01 f1 ffff - Read the 1st index data from on timer.

Example 2: fd 01 e1 ffff - Delete the 1st index data from on timer.

Example 3: fd 01 04 02 03 - Set on timer at 02:03 on Monday to Saturday.

* This function is only available when Clock 1 (year/month/day) and Clock 2 (hour/minute/second) are set.

Acknowledgement`[d][][Set ID][][OK/NG][Data1][Data2][Data3][x]`

26. On timer input (Command: f u)

Adds a new schedule entry by selecting input for the current on timer setting.

Transmission

[f][u][][Set ID][][Data1][Cr]

[f][u][][Set ID][][Data1][Data2][Cr]

Data (adding schedule)

60: RGB

70: DVI-D

90: HDMI (HDMI1)

91: OPS (DTV)

C0: DISPLAYPORT (DTV)

Data1

1. f1h to f7h (reading data)

F1: Select the 1st schedule input source

F2: Select the 2nd schedule input source

F3: Select the 3rd schedule input source

F4: Select the 4th schedule input source

F5: Select the 5th schedule input source

F6: Select the 6th schedule input source

F7: Select the 7th schedule input source

Data2

1. ffh (reading data)

To read the schedule input, enter FFH for [Data2].

If no schedule is available for [Data1] when attempting to read or change the schedule data, the text NG will be displayed and the operation will fail.

(Example 1: fu 01 60 - Move existing schedule entries down one row each and save RGB as input source for the 1st schedule entry.)

(Example 2: fu 01 f1 ff - Read the 1st schedule input data.)

* This function is only supported when 1 (year/month/date), 2 (hour/minute/second) and On Time (repeat mode/time) are set.
** Input may not be supported on some models.

Acknowledgement

[u][][Set ID][][OK/NG][Data][x]

[u][][Set ID][][OK/NG][Data1][Data2][x]

27. Automatic standby (Command: m n)

Configures the automatic standby settings.

Transmission

[m][n][][Set ID][][Data][Cr]

Data

00: Off (Will not turn off after 4/6/8 hours)

01: 4 hours (Off after 4 hours)

02: 6 hours (Off after 6 hours)

03: 8 hours (Off after 8 hours)

Acknowledgement

[n][][Set ID][][OK/NG][Data][x]

28. Auto off (Command: f g)

Configures the automatic off settings.

Transmission

[f][g][][Set ID][][Data][Cr]

Data

00: Off (Will not turn off after 15 minutes)

01: On (Off after 15 minutes)

Acknowledgement

[g][][Set ID][][OK/NG][Data][x]

29. Language (Command: f i)

Sets the OSD language.

Transmission

[f][i][][Set ID][][Data][Cr]

Data

00: Czech

01: Danish

02: German

03: English

04: Spanish (Europe)

05: Greek

06: French

07: Italian

08: Dutch

09: Norwegian

0A: Portuguese

0B: Portuguese (Brazil)

0C: Russian

0D: Finnish

0E: Swedish

0F: Korean

10: Chinese (Cantonese)

11: Japanese

12: Chinese (Mandarin)

Acknowledgement

[i][][Set ID][][OK/NG][Data][x]

30. Reset (Command: f k)

Resets settings for Picture, Screen and Audio or restores factory settings.

(Screen reset can only be performed in RGB input mode.)

Transmission

[f][k][][Set ID][][Data][Cr]

Data 00: Picture reset
01: Screen reset
02: Initial settings (factory reset)

Acknowledgement

[k][][Set ID][][OK/NG][Data][x]

31. Current temperature (Command: d n)

Checks the inside temperature value.

Transmission

[d][n][][Set ID][][Data][Cr]

Data FF: Check status

Acknowledgement

[n][][Set ID][][OK/NG][Data][x]

[n][][Set ID][][OK/NG][Data1][Data2][Data3][x]

* Temperature is displayed as a hexadecimal value.

32. Key (Command: m c)

Sends a key code for the IR remote control.

Transmission

[m][c][][Set ID][][Data][Cr]

Data IR_KEY_CODE

Acknowledgement

[c][][Set ID][][OK/NG][Data][x]

For key codes, see IR Codes.

* Some key codes may not be supported on some models.

33. Time elapsed (Command: d l)

Checks the elapsed time.

Transmission

[d][l][][Set ID][][Data][Cr]

Data FF: Read status

Acknowledgement

[l][][Set ID][][OK/NG][Data][x]

* The data received is shown as a hexadecimal value.

34. Product serial number (Command: f y)

Checks the serial number of the product.

Transmission

[f][y][][Set ID][][Data][Cr]

Data FF: Check product serial number

Acknowledgement

[y][][Set ID][][OK/NG][Data][x]

* Data is in ASCII code.

35. Software version (Command: f z)

Checks the software version of the product.

Transmission

[f][z][][Set ID][][Data][Cr]

Data FF: Check software version

Acknowledgement

[z][][Set ID][][OK/NG][Data][x]

36. White balance red gain (Command: j m)

Adjusts the white balance red gain value.

Transmission

[j][m][][Set ID][][Data][Cr]

Data 00 to FE: Red gain 0 to 254

Acknowledgement

[m][][Set ID][][OK/NG][Data][x]

37. White balance green gain (Command: j n)

Adjusts the white balance green gain value.

Transmission

[j][n][][Set ID][][Data][Cr]

Data 00 to FE: Green gain 0 to 254

Acknowledgement

[n][][Set ID][][OK/NG][Data][x]

38. White balance blue gain (Command: j o)

Adjusts the white balance blue gain value.

Transmission

[j][o][][Set ID][][Data][Cr]

Data 00 to FE: Blue gain 0 to 254

Acknowledgement

[o][][Set ID][][OK/NG][Data][x]

39. Backlight (Command: m g)

Adjusts the back light brightness.

Transmission

[m][g][][Set ID][][Data][Cr]

Data 00 to 64: Back light brightness 0 to 100

Acknowledgement

[g][][Set ID][][OK/NG][Data][x]

** This may not be supported on some models.

40. Screen off (Command: k d)

Turns the screen on or off.

Transmission

[k][d][][Set ID][][Data][Cr]

Data 00: Turns the screen on
01: Turns the screen off

Acknowledgement

[d][][Set ID][][OK/NG][Data][x]

41. Tile Mode (Command: d d)

To set a Tile Mode and Tile Column/ Row values.

Transmission

[d][d][][Set ID][][Data][Cr]

Data 00 to FF: 1st byte - Tile Row
2nd byte - Tile Column

*00, 01, 10, 11 means Tile Mode Off

** It may not be supported depending on the model.

Acknowledgement

[d][][Set ID][][OK/NG][Data][x]

42. Tile Mode Check (Command: d z)

To check Tile Mode status.

Transmission

[d][z][][Set ID][][Data][Cr]

Data FF: Check Tile Mode status.

** It may not be supported depending on the model.

Acknowledgement

[z][][Set ID][][OK/NG][Data1][Data2][Data3][x]

Data1 00: Tile Mode Off

01: Tile Mode On

Data2 00 to 0F: Tile Row

Data3 00 to 0F: Tile Column

43. Tile ID (Command: d i)

To set Tile ID.

Transmission

[d][i][][Set ID][][Data][Cr]

Data 01 to E1: Tile ID 01 to 225**

FF: Check Tile ID

** Data could not be set over (Tile Column) x (Tile Row).

** It may not be supported depending on the model.

Acknowledgement

[i][][Set ID][][OK/NG][Data][x]

*NG will be return if data is over (Tile Column) x (Tile Row), except 0xFF.

44. Tile H Position (Command: d e)

To adjust the Tile Horizontal position.

* This function is available only when the Natural option of the Tile Mode is set to Off while the Tile Mode set to On.

Transmission

[d][e][][Set ID][][Data][Cr]

Data 00 to 32: -50 (Left) to 0 (Right)

*Left/Right values depend on Tile H size.

** It may not be supported depending on the model.

Acknowledgement

[e][][Set ID][][OK/NG][Data][x]

45. Tile V Position (Command: d f)

To adjust the Tile Vertical position.

* This function is available only when the Natural option of the Tile Mode is set to Off while the Tile Mode set to On.

Transmission

[d][f][][Set ID][][Data][Cr]

Data 0 to 32: 0 (Bottom) to 50 (Top)

* Bottom/Top values depend on Tile Vertical size.

** It may not be supported depending on the model.

Acknowledgement

[f][][Set ID][][OK/NG][Data][x]

46. Tile H Size (Command: d g)

To adjust the Tile Horizontal size.

*Set Tile H Position to 0x32 before setting Tile H Size.

* This function is available only when the Natural option of the Tile Mode is set to Off while the Tile Mode set to On.

Transmission

[d][g][][Set ID][][Data][Cr]

Data 00 to 32: 0 to 50

** It may not be supported depending on the model.

Acknowledgement

[g][][Set ID][][OK/NG][Data][x]

47. Tile V Size (Command: d h)

To adjust the Tile Vertical size.

*Set Tile V Position to 0x00 before setting Tile V Size.

* This function is available only when the Natural option of the Tile Mode is set to Off while the Tile Mode set to On.

Transmission

[d][h][][Set ID][][Data][Cr]

Data 00 to 32: 0 to 50

** It may not be supported depending on the model.

Acknowledgement

[h][][Set ID][][OK/NG][Data][x]

48. Natural Mode (In Tile Mode) (Command : d j)

To display the image naturally, the part of the image that would normally be displayed in the gap between the monitors is omitted.

Transmission`[d][j][][Set ID][][Data][Cr]`

Data 00: Off
 01: On

Acknowledgement`[j][][Set ID][][OK/NG][Data][x]`

