



Cisco UCS Servers RAID Guide

June 19, 2013

Americas Headquarters

Cisco Systems, Inc.
170 West Tasman Drive
San Jose, CA 95134-1706
USA
<http://www.cisco.com>
Tel: 408 526-4000
800 553-NETS (6387)
Fax: 408 527-0883

Text Part Number: OL-26591-01

THE SPECIFICATIONS AND INFORMATION REGARDING THE PRODUCTS IN THIS MANUAL ARE SUBJECT TO CHANGE WITHOUT NOTICE. ALL STATEMENTS, INFORMATION, AND RECOMMENDATIONS IN THIS MANUAL ARE BELIEVED TO BE ACCURATE BUT ARE PRESENTED WITHOUT WARRANTY OF ANY KIND, EXPRESS OR IMPLIED. USERS MUST TAKE FULL RESPONSIBILITY FOR THEIR APPLICATION OF ANY PRODUCTS.

THE SOFTWARE LICENSE AND LIMITED WARRANTY FOR THE ACCOMPANYING PRODUCT ARE SET FORTH IN THE INFORMATION PACKET THAT SHIPPED WITH THE PRODUCT AND ARE INCORPORATED HEREIN BY THIS REFERENCE. IF YOU ARE UNABLE TO LOCATE THE SOFTWARE LICENSE OR LIMITED WARRANTY, CONTACT YOUR CISCO REPRESENTATIVE FOR A COPY.

The following information is for FCC compliance of Class A devices: This equipment has been tested and found to comply with the limits for a Class A digital device, pursuant to part 15 of the FCC rules. These limits are designed to provide reasonable protection against harmful interference when the equipment is operated in a commercial environment. This equipment generates, uses, and can radiate radio-frequency energy and, if not installed and used in accordance with the instruction manual, may cause harmful interference to radio communications. Operation of this equipment in a residential area is likely to cause harmful interference, in which case users will be required to correct the interference at their own expense.

The following information is for FCC compliance of Class B devices: This equipment has been tested and found to comply with the limits for a Class B digital device, pursuant to part 15 of the FCC rules. These limits are designed to provide reasonable protection against harmful interference in a residential installation. This equipment generates, uses and can radiate radio frequency energy and, if not installed and used in accordance with the instructions, may cause harmful interference to radio communications. However, there is no guarantee that interference will not occur in a particular installation. If the equipment causes interference to radio or television reception, which can be determined by turning the equipment off and on, users are encouraged to try to correct the interference by using one or more of the following measures:

- Reorient or relocate the receiving antenna.
- Increase the separation between the equipment and receiver.
- Connect the equipment into an outlet on a circuit different from that to which the receiver is connected.
- Consult the dealer or an experienced radio/TV technician for help.

Modifications to this product not authorized by Cisco could void the FCC approval and negate your authority to operate the product.

The Cisco implementation of TCP header compression is an adaptation of a program developed by the University of California, Berkeley (UCB) as part of UCB's public domain version of the UNIX operating system. All rights reserved. Copyright © 1981, Regents of the University of California.

NOTWITHSTANDING ANY OTHER WARRANTY HEREIN, ALL DOCUMENT FILES AND SOFTWARE OF THESE SUPPLIERS ARE PROVIDED "AS IS" WITH ALL FAULTS. CISCO AND THE ABOVE-NAMED SUPPLIERS DISCLAIM ALL WARRANTIES, EXPRESSED OR IMPLIED, INCLUDING, WITHOUT LIMITATION, THOSE OF MERCHANTABILITY, FITNESS FOR A PARTICULAR PURPOSE AND NONINFRINGEMENT OR ARISING FROM A COURSE OF DEALING, USAGE, OR TRADE PRACTICE.

IN NO EVENT SHALL CISCO OR ITS SUPPLIERS BE LIABLE FOR ANY INDIRECT, SPECIAL, CONSEQUENTIAL, OR INCIDENTAL DAMAGES, INCLUDING, WITHOUT LIMITATION, LOST PROFITS OR LOSS OR DAMAGE TO DATA ARISING OUT OF THE USE OR INABILITY TO USE THIS MANUAL, EVEN IF CISCO OR ITS SUPPLIERS HAVE BEEN ADVISED OF THE POSSIBILITY OF SUCH DAMAGES.

Cisco and the Cisco logo are trademarks or registered trademarks of Cisco and/or its affiliates in the U.S. and other countries. To view a list of Cisco trademarks, go to this URL: www.cisco.com/go/trademarks. Third-party trademarks mentioned are the property of their respective owners. The use of the word partner does not imply a partnership relationship between Cisco and any other company. (1110R)

Any Internet Protocol (IP) addresses and phone numbers used in this document are not intended to be actual addresses and phone numbers. Any examples, command display output, network topology diagrams, and other figures included in the document are shown for illustrative purposes only. Any use of actual IP addresses or phone numbers in illustrative content is unintentional and coincidental.

Cisco UCS Servers RAID Guide

© 2013 Cisco Systems, Inc. All rights reserved.



CONTENTS

Preface vii

Organization vii

Conventions 1-viii

Related Documentation ix

Obtaining Documentation and Submitting a Service Request ix

CHAPTER 1

RAID Overview 1-1

Information About RAID 1-1

 Drive Group 1-1

 Virtual Drive 1-1

 Disk Striping 1-2

 Disk Mirroring (RAID 1 and RAID 10) 1-2

 Parity 1-3

 Disk Spanning 1-3

 Hot Spares 1-4

 Global Hot Spare 1-5

 Dedicated Hot Spare 1-5

 Disk Rebuilds 1-6

 Hot Swap 1-6

 Drive States 1-7

 Virtual Drive States 1-7

RAID Levels 1-7

 RAID Levels Summary 1-8

 RAID 0 1-8

 RAID 1 1-9

 RAID 5 1-10

 RAID 6 1-11

 RAID 00 1-12

 RAID 10 1-13

 RAID 50 1-14

 RAID 60 1-15

 Fault Tolerance 1-16

Generic Drive Replacement Procedure 1-17

 Removing a Drive from a Server 1-17

Installing a Drive in a Server 1-18
 Platform-Specific RAID and Drive Procedures 1-18

CHAPTER 2

Using Cisco Integrated Management Controller and Cisco UCS Server Configuration Utility for RAID Monitoring and Configuring 2-1

Cisco Integrated Management Controller—Viewing Storage Properties 2-1
 Cisco UCS Server Configuration Utility—RAID Configuration 2-2

CHAPTER 3

Using Cisco UCS Manager for RAID Configuring and Monitoring 3-1

Cisco UCS Manager Configuration 3-1
 Local Disk Configuration Policy 3-1
 Guidelines for all Local Disk Configuration Policies 3-2
 Guidelines for Local Disk Configuration Policies Configured for RAID 3-3
 Creating a Local Disk Configuration Policy 3-4
 Changing a Local Disk Configuration Policy 3-6
 Deleting a Local Disk Configuration Policy 3-7
 Server Disk Drive Monitoring 3-7
 Support for Disk Drive Monitoring 3-7
 Viewing the Status of a Disk Drive 3-8
 Interpreting the Status of a Monitored Disk Drive 3-9
 RAID Controllers in UCS Servers 3-10
 Determining Which Controller is in Your Server 3-11
 RAID Controllers 3-12
 Disabling Quiet Boot 3-12
 Accessing ROM-Based Controller Utilities 3-13
 Documentation About RAID Controllers and LSI Utilities 3-13
 Moving a RAID Cluster Using UCS Software Version 1.4(1) 3-13
 Moving a RAID Cluster Using UCS Software Version 1.4(2) and Later Releases 3-14
 Moving a RAID Cluster Between B200 M3 Servers 3-15
 Replacing a Failed Drive in a RAID Cluster 3-16

CHAPTER 4

Configuring the LSI SAS2 Integrated RAID Controller 4-1

Information about LSI Integrated RAID 4-1
 Mirrored Volumes 4-2
 Operation of Mirrored Volumes 4-3
 Mirrored Volume Features 4-6
 Mirroring and Mirroring Enhanced Features 4-7
 Integrated Striping 4-8
 Integrated Striping Features 4-9

Creating Mirrored Volumes	4-10
Launching the LSI SAS2 BIOS Configuration Utility	4-10
Creating Mirrored Volumes	4-11
Creating an Integrated Mirroring Volume	4-11
Creating an Integrated Mirroring Enhanced or Integrated Mirroring and Striping Volume	4-13
Expanding an Integrated Mirroring Volume with OCE	4-14
Managing Hot Spare Disks	4-15
Creating Hot Spare Disks	4-15
Deleting Hot Spare Disks	4-15
Other Configuration Tasks	4-16
Viewing Volume Properties	4-16
Running a Consistency Check	4-16
Activating an Array	4-17
Deleting an Array	4-17
Locating Disk Drives in a Volume	4-18
Choosing a Boot Disk	4-18
Creating Integrated Striping Volumes	4-19
Other Configuration Tasks	4-21
Viewing Volume Properties	4-21
Activating an Array	4-21
Deleting an Array	4-21
Locating Disk Drives in a Volume	4-22
Choosing a Boot Disk	4-23
Determining Which Controller is in Your Server	4-23
Disabling Quiet Boot for CIMC Firmware Earlier than Release 1.2(1)	4-24
Launching Option ROM-Based Controller Utilities	4-24
Restoring RAID Configuration After Replacing a RAID Controller	4-25

CHAPTER 5

LSI MegaRAID SAS Controller Tasks	5-1
LSI MegaRAID Controller Management Utilities	5-1
LSI WebBIOS Configuration Utility	5-1
MegaRAID Command Tool	5-1
MegaRAID Storage Manager	5-2
LSI WebBIOS CU	5-2
Starting the WebBIOS CU	5-2
WebBIOS CU Main Menu Window Options	5-3
Toolbar	5-4
Menu Options	5-4
Configuring RAID Drive Groups and Virtual Drives	5-5

- Choosing the Configuration with the Configuration Wizard 5-5
- Using Automatic Configuration 5-5
- Using Manual Configuration 5-6
- Viewing and Changing Device Properties 5-11
 - Viewing Controller Properties 5-11
 - Viewing Virtual Drive Properties, Policies, and Operations 5-13
 - Viewing Physical Drive Properties and Operations 5-14
 - Viewing and Changing Battery Backup Unit Information 5-15
- Managing RAID 5-16
 - Expanding a Virtual Drive 5-16
 - Monitoring Array Health 5-16
 - Recovery 5-17
 - Deleting a Virtual Drive 5-18
 - Migrating an Array to a New Server 5-18
 - Foreign Configurations in Cable Pull and Drive Removal Scenarios 5-19
 - Importing Foreign Configurations from Integrated RAID to MegaRAID 5-20
 - Troubleshooting Information 5-20
 - Migrating the RAID Level of a Virtual Drive 5-20
- Determining Which Controller is in Your Server 5-21
 - Disabling Quiet Boot for CIMC Firmware Earlier than Release 1.2(1) 5-22
 - Launching an Option ROM-Based Controller Utility 5-22
 - LSI MegaRAID Card Beep Codes 5-23
 - Restoring the RAID Configuration After Replacing a RAID Controller 5-23

CHAPTER 6

- Configuring the Embedded ICH10R SATA Controller 6-1**
 - Enabling the Integrated Intel ICH10R RAID Controller in the BIOS 6-1
 - Launching the LSI Software RAID Setup Utility 6-1
 - Configuring the Onboard Intel ICH10R RAID Controller 6-2
 - Creating a New RAID Configuration 6-3
 - Viewing or Changing a RAID Configuration 6-4



Preface

This preface describes the organization of the *Cisco UCS C-Series Servers RAID Configuration Guide*. It also provides information on how to obtain related documentation and submit a service request.

Organization

This guide is organized as into the following chapters:

Chapter	Title	Description
Chapter 1	RAID Overview	Describes Redundant Array of Independent Disks (RAID), RAID functions and benefits, RAID components, RAID levels, and configuration strategies. It also describes RAID availability and offers tips for configuration planning.
Chapter 2	Using Cisco Integrated Management Controller and Cisco UCS Server Configuration Utility for RAID Monitoring and Configuring	Summarizes monitoring and configuring RAID controllers using Cisco Integrated Management Controller (CIMC) and Cisco UCS Server Configuration Utility (UCS-SCU).
Chapter 3	Using Cisco UCS Manager for RAID Configuring and Monitoring	Summarizes monitoring and configuring RAID controllers using Cisco UCS Manager.
Chapter 4	Configuring the LSI SAS2 Integrated RAID Controller	Provides an introduction to the features and benefits of the LSI Integrated RAID solution for LSI SAS2 RAID controllers.
Chapter 5	LSI MegaRAID SAS Controller Tasks	Describes the LSI WebBIOS Configuration Utility (CU) and describes creating and managing RAID configurations on LSI MegaRAID SAS controllers.
Chapter 6	Configuring the Embedded ICH10R SATA Controller	Describes how to use the LSI Software RAID setup Utility to configure the onboard Intel ICH10R RAID controller.

Conventions

This document uses the following conventions:

Convention	Indication
bold font	Commands and keywords and user-entered text appear in bold font .
<i>italic font</i>	Document titles, new or emphasized terms, and arguments for which you supply values are in <i>italic font</i> .
[]	Elements in square brackets are optional.
{ x y z }	Required alternative keywords are grouped in braces and separated by vertical bars.
[x y z]	Optional alternative keywords are grouped in brackets and separated by vertical bars.
string	A nonquoted set of characters. Do not use quotation marks around the string or the string will include the quotation marks.
<code>courier font</code>	Terminal sessions and information the system displays appear in <code>courier font</code> .
< >	Non-printing characters such as passwords are in angle brackets.
[]	Default responses to system prompts are in square brackets.
!, #	An exclamation point (!) or a pound sign (#) at the beginning of a line of code indicates a comment line.



Note

Means *reader take note*.



Tip

Means *the following information will help you solve a problem*.



Caution

Means *reader be careful*. In this situation, you might perform an action that could result in equipment damage or loss of data.



Timesaver

Means *the described action saves time*. You can save time by performing the action described in the paragraph.



Warning

Means ***reader be warned***. In this situation, you might perform an action that could result in **bodily injury**.

Related Documentation

The documentation set for the Cisco Unified Computing System (UCS) C-Series rack-mount servers is described in the roadmap document at the following link:

[Cisco UCS C-Series Documentation Roadmap](#)

Obtaining Documentation and Submitting a Service Request

For information on obtaining documentation, submitting a service request, and gathering additional information, see the monthly *What's New in Cisco Product Documentation*, which also lists all new and revised Cisco technical documentation, at:

<http://www.cisco.com/en/US/docs/general/whatsnew/whatsnew.html>

Subscribe to the *What's New in Cisco Product Documentation* as an RSS feed and set content to be delivered directly to your desktop using a reader application. The RSS feeds are a free service. Cisco currently supports RSS Version 2.0.



CHAPTER 1

RAID Overview

This chapter describes RAID (Redundant Array of Independent Disks), RAID functions and benefits, RAID components, RAID levels, and configuration strategies.

This chapter contains the following sections:

- [Information About RAID, page 1-1](#)
- [RAID Levels, page 1-7](#)
- [Generic Drive Replacement Procedure, page 1-17](#)
- [Platform-Specific RAID and Drive Procedures, page 1-18](#)

Information About RAID

RAID is an array, or group, of multiple independent physical drives that provide high performance and fault tolerance. A RAID drive group improves input/output (I/O) performance and reliability. The RAID drive group appears to the host computer as a single storage unit or as multiple virtual units. I/O is expedited because several drives can be accessed simultaneously.

RAID drive groups improve data storage reliability and fault tolerance compared to single-drive storage systems. Data loss resulting from a drive failure can be prevented by reconstructing missing data from the remaining drives. RAID improves I/O performance and increases storage subsystem reliability.

RAID levels describe a system for ensuring the availability and redundancy of data stored on large disk subsystems. See [RAID Levels, page 1-7](#) for detailed information about RAID levels. The RAID drive-group components and RAID levels are described in the following sections.

Drive Group

A drive group is a group of physical drives. These drives are managed in partitions known as virtual drives.

Virtual Drive

A virtual drive is a partition in a drive group that is made up of contiguous data segments on the drives. A virtual drive can consist of an entire drive group, more than one entire drive group, a part of a drive group, parts of more than one drive group, or a combination of any two of these conditions.

Disk Striping

Disk striping (used in RAID level 0) allows you to write data across multiple drives instead of only one drive. Disk striping involves partitioning each drive storage space into stripes that can vary in size from 8 KB to 1024 KB. These stripes are interleaved in a repeated sequential manner. The combined storage space is composed of stripes from each drive. We recommend that you keep stripe sizes the same across RAID drive groups.

For example, in a four-disk system using only disk striping, segment 1 is written to disk 1, segment 2 is written to disk 2, and so on (see [Figure 1-1](#)). Disk striping enhances performance because multiple drives are accessed simultaneously, but disk striping does not provide data redundancy.

Figure 1-1 Example of Disk Striping (RAID 0)

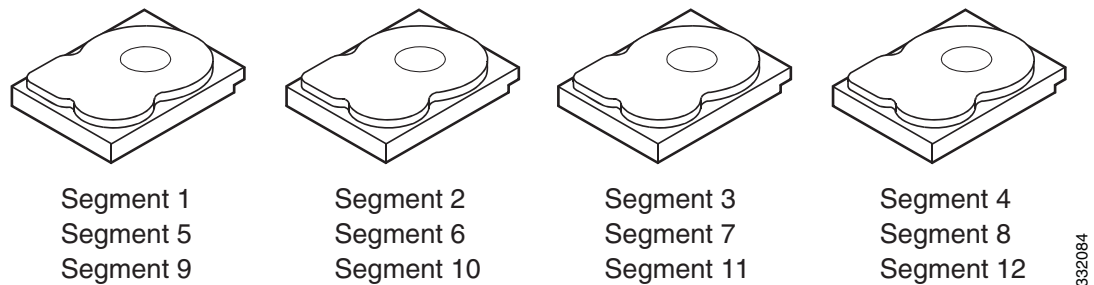

332084

Stripe width is the number of drives involved in a drive group where striping is implemented. For example, a four-disk drive group with disk striping has a stripe width of four.

The stripe size is the length of the interleaved data segments that the RAID controller writes across multiple drives, not including parity drives. For example, consider a stripe that contains 64 KB of disk space and has 16 KB of data residing on each disk in the stripe. In this case, the stripe size is 64 KB and the strip size is 16 KB.

The strip size is the portion of a stripe that resides on a single drive.

Disk Mirroring (RAID 1 and RAID 10)

With disk mirroring (used in RAID 1 and RAID 10), data written to one drive is simultaneously written to another drive. The primary advantage of disk mirroring is that it provides 100 percent data redundancy. Because the contents of the disk are completely written to a second disk, data is not lost if one disk fails. In addition, both drives contain the same data at all times, so either disk can act as the operational disk. If one disk fails, the contents of the other disk can be used to run the system and reconstruct the failed disk.

Disk mirroring provides 100 percent redundancy but is expensive because each drive in the system must be duplicated (see [Figure 1-2](#)).

Figure 1-2 Example of Disk Mirroring (RAID 1)

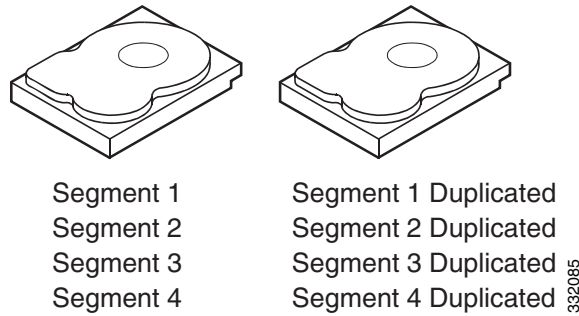

332085

Parity

Parity generates a set of redundancy data from two or more parent data sets. The redundancy data can be used to reconstruct one of the parent data sets in the event of a drive failure. Parity data does not fully duplicate the parent data sets, but parity generation can slow the write process. In RAID, this method is applied to entire drives or stripes across all of the drives in a drive group. There are two types of parity:

- Dedicated parity—The parity data on two or more drives is stored on an additional disk.
- Distributed parity—The parity data is distributed across more than one drive in the system.

RAID 5 combines distributed parity with disk striping (see Figure 1-3). If a single drive fails, it can be rebuilt from the parity and the data on the remaining drives. RAID 5 uses parity to provide redundancy for one drive failure without duplicating the contents of entire drives. RAID 6 uses distributed parity and disk striping also but adds a second set of parity data so that it can survive up to two drive failures.



Note

Parity is distributed across all drives in the drive group.

Figure 1-3 Example of Distributed Parity (RAID 5)

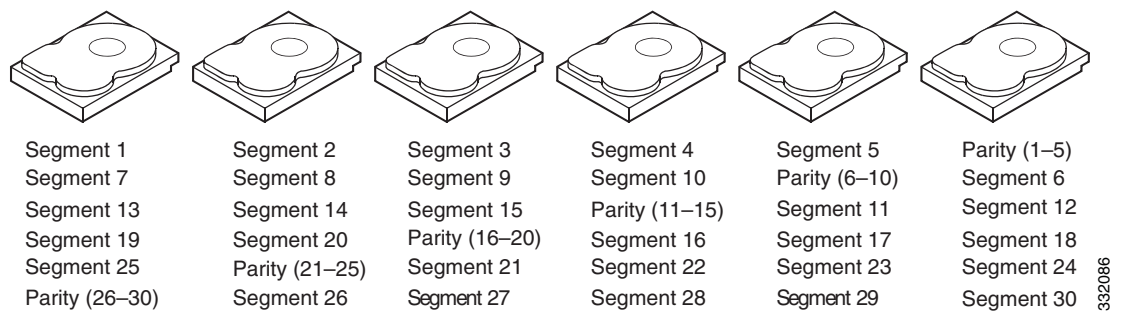

332086

Disk Spanning

Disk spanning allows multiple drives to function like one big drive. Spanning overcomes lack of disk space and simplifies storage management by combining existing resources or adding relatively inexpensive resources. For example, four 20-GB drives can be combined to appear to the operating system as a single 80-GB drive.

Spanning alone does not provide reliability or performance enhancements. Spanned virtual drives must have the same stripe size and must be contiguous. In Figure 1-4, RAID 1 drive groups are turned into a RAID 10 drive group.



Note

Make sure that the spans are in different backplanes, so that if one span fails, you do not lose the whole drive group.

Figure 1-4 Example of Disk Spanning

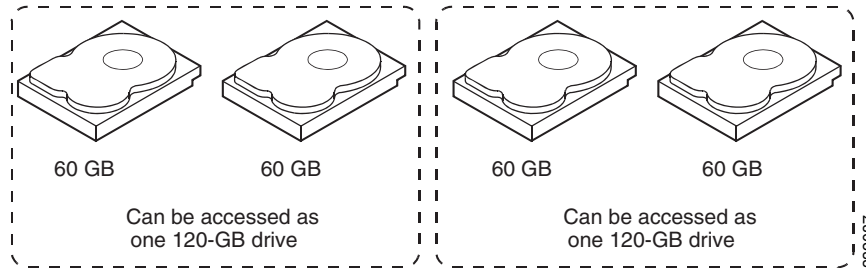

Spanning two contiguous RAID 0 virtual drives does not produce a new RAID level or add fault tolerance. It does increase the capacity of the virtual drive and improves performance by doubling the number of physical disks.

Table 1-1 describes how to configure RAID 00, RAID 10, RAID 50, and RAID 60 by spanning. The virtual drives must have the same stripe size and the maximum number of spans is eight. The full drive capacity is used when you span virtual drives; you cannot specify a smaller drive capacity.

Table 1-1 Spanning for RAID 00, RAID 10, RAID 50, and RAID 60

RAID Level	Description
00	Configure RAID 00 by spanning two contiguous RAID 0 virtual drives, up to the maximum number of supported devices for the controller.
10	Configure RAID 10 by spanning two contiguous RAID 1 virtual drives, up to the maximum number of supported devices for the controller. RAID 10 supports a maximum of eight spans. You must use an even number of drives in each RAID virtual drive in the span. The RAID 1 virtual drives must have the same stripe size.
50	Configure RAID 50 by spanning two contiguous RAID 5 virtual drives. The RAID 5 virtual drives must have the same stripe size.
60	Configure RAID 60 by spanning two contiguous RAID 6 virtual drives. The RAID 6 virtual drives must have the same stripe size.

Hot Spares

A hot spare is an extra, unused drive that is part of the disk subsystem. It is usually in standby mode, ready for service if a drive fails. If a drive used in a RAID virtual drive fails, a hot spare automatically takes its place and the data on the failed drive is rebuilt on the hot spare. Hot spares can be used for RAID levels 1, 5, 6, 10, 50, and 60.

Hot spares permit you to replace failed drives without system shutdown or user intervention. MegaRAID SAS RAID controllers can implement automatic and transparent rebuilds of failed drives using hot spare drives, providing a high degree of fault tolerance and zero downtime.

**Note**

When running RAID 0 and RAID 5 virtual drives on the same set of drives (a sliced configuration), a rebuild to a hot spare cannot occur after a drive failure until the RAID 0 virtual drive is deleted.

The LSI RAID management software allows you to specify drives as hot spares. When a hot spare is needed, the RAID controller assigns the hot spare that has a capacity closest to and at least as great as that of the failed drive to take the place of the failed drive. The failed drive is removed from the virtual drive and marked ready awaiting removal once the rebuild to a hot spare begins. You can make hot spares of the drives that are not in a RAID virtual drive.

You can use the RAID management software to designate the hot spare to have enclosure affinity, which means that if drive failures are present on a split backplane configuration, the hot spare is used first on the backplane side that it resides in.

If the hot spare is designated as having enclosure affinity, it attempts to rebuild any failed drives on the backplane that it resides in before rebuilding any other drives on other backplanes.

**Note**

If a rebuild to a hot spare fails for any reason, the hot spare drive is marked as failed. If the source drive fails, both the source drive and the hot spare drive is marked as failed.

There are two types of hot spares:

- Global hot spare
- Dedicated hot spare

Global Hot Spare

A global hot spare drive can be used to replace any failed drive in a redundant drive group as long as its capacity is equal to or larger than the capacity of the failed drive. A global hot spare defined on any channel should be available to replace a failed drive on both channels.

Dedicated Hot Spare

A dedicated hot spare can be used to replace a failed drive only in a chosen drive group. One or more drives can be designated as a member of a spare drive pool. The most suitable drive from the pool is chosen for failover. A dedicated hot spare is used before one from the global hot spare pool.

Hot spare drives can be located on any RAID channel. Standby hot spares (not being used in RAID drive group) are polled every 60 seconds at a minimum, and their status is made available in the drive group management software. RAID controllers offer the ability to rebuild with a disk that is in a system, but not initially set to be a hot spare.

When using hot spares, observe the following guidelines:

- Hot spares are used only in drive groups with redundancy, which includes RAID levels 1, 5, 6, 10, 50, and 60.
- A hot spare connected to a specific RAID controller can be used to rebuild a drive that is connected to the same controller only.

- You must assign the hot spare to one or more drives through the controller BIOS or use drive group management software to place it in the hot spare pool.
- A hot spare must have free space equal to or greater than the drive it replaces. For example, to replace an 18-GB drive, the hot spare must be 18 GB or larger.

Disk Rebuilds

When a drive in a RAID drive group fails, you can rebuild the drive by recreating the data that was stored on the drive before it failed. The RAID controller recreates the data using the data stored on the other drives in the drive group. Rebuilding can be done only in drive groups with data redundancy, which includes RAID 1, 5, 6, 10, 50, and 60 drive groups.

The RAID controller uses hot spares to rebuild failed drives automatically and transparently, at user-defined rebuild rates. If a hot spare is available, the rebuild can start automatically when a drive fails. If a hot spare is not available, the failed drive must be replaced with a new drive so that the data on the failed drive can be rebuilt.

The failed drive is removed from the virtual drive and marked ready awaiting removal when the rebuild to a hot spare begins. If the system goes down during a rebuild, the RAID controller automatically restarts the rebuild after the system reboots.

**Note**

When the rebuild to a hot spare begins, the failed drive is often removed from the virtual drive before management applications detect the failed drive. When this situation occurs, the events logs show the drive rebuilding to the hot spare without showing the failed drive. The formerly failed drive is marked as *ready* after a rebuild begins to a hot spare.

**Note**

If a source drive fails during a rebuild to a hot spare, the rebuild fails, and the failed source drive is marked as offline. In addition, the rebuilding hot spare drive is changed back to a hot spare. After a rebuild fails because of a source drive failure, the dedicated hot spare is still dedicated and assigned to the correct drive group, and the global hot spare is still global.

An automatic drive rebuild does not start if you replace a drive during a RAID-level migration. The rebuild must be started manually after the expansion or migration procedure is complete. (RAID-level migration changes a virtual drive from one RAID level to another.)

Hot Swap

A hot swap is the manual replacement of a defective drive unit while the computer is still running (performing its normal functions). When a new drive is installed, a rebuild occurs automatically if one of the following happens:

- The newly inserted drive is the same capacity as or larger than the failed drive.
- It is placed in the same drive bay as the failed drive it is replacing.

The RAID controller can be configured to detect the new drives and rebuild the contents of the drive automatically. The backplane and enclosure must support hot swap for the functionality to work.

Drive States

A drive state is a property that indicates the status of the drive. [Table 1-2](#) describes the drive states.

Table 1-2 *Drive States*

State	Description
Online	A drive that can be accessed by the RAID controller and is part of the virtual drive.
Unconfigured Good	A drive that is functioning normally but is not configured as a part of a virtual drive or as a hot spare.
Hot Spare	A drive that is powered up and ready for use as a spare in case an online drive fails.
Failed	A drive that was originally configured as Online or Hot Spare but on which the firmware detects an unrecoverable error.
Rebuild	A drive to which data is being written to restore full redundancy for a virtual drive.
Unconfigured Bad	A drive on which the firmware detects an unrecoverable error; the drive was Unconfigured Good or the drive could not be initialized.
Missing	A drive that was Online but which has been removed from its location.
Offline	A drive that is part of a virtual drive but which has invalid data as far as the RAID configuration is concerned. When a virtual drive with cached data goes offline, the cache for the virtual drive is discarded. Because the virtual drive is offline, the cache cannot be saved.

Virtual Drive States

A virtual drive state is a property indicating the status of the virtual drive. [Table 1-3](#) describes the virtual drive states.

Table 1-3 *Virtual Drive States*

State	Description
Optimal	The virtual drive operating condition is good. All configured drives are online.
Degraded	The virtual drive operating condition is not optimal. One of the configured drives has failed or is offline.
Partial Degraded	The operating condition in a RAID 6 virtual drive is not optimal. One of the configured drives has failed or is offline. RAID 6 can tolerate up to two drive failures.
Failed	The virtual drive has failed.
Offline	The virtual drive is not available to the RAID controller.

RAID Levels

The MegaRAID controller supports RAID levels 0, 00, 1, 5, 6, 10, 50, and 60. It also supports independent drives (configured as RAID 0 and RAID 00.) The supported RAID levels are summarized in the following section.

RAID Levels Summary

- RAID 0 uses striping to provide high data throughput, especially for large files in an environment that does not require fault tolerance.
- RAID 1 uses mirroring so that data written to one drive is simultaneously written to another drive which is good for small databases or other applications that require small capacity, but complete data redundancy.
- RAID 5 uses disk striping and parity data across all drives (distributed parity) to provide high data throughput, especially for small random access.
- RAID 6 uses distributed parity, with two independent parity blocks per stripe, and disk striping. A RAID 6 virtual drive can survive the loss of two drives without losing data. A RAID 6 drive group, which requires a minimum of three drives, is similar to a RAID 5 drive group. Blocks of data and parity information are written across all drives. The parity information is used to recover the data if one or two drives fail in the drive group.
- A RAID 00 drive group is a spanned drive group that creates a striped set from a series of RAID 0 drive groups.
- RAID 10, a combination of RAID 0 and RAID 1, consists of striped data across mirrored spans. A RAID 10 drive group is a spanned drive group that creates a striped set from a series of mirrored drives. RAID 10 allows a maximum of eight spans. You must use an even number of drives in each RAID virtual drive in the span. The RAID 1 virtual drives must have the same stripe size. RAID 10 provides high data throughput and complete data redundancy but uses a larger number of spans.
- RAID 50, a combination of RAID 0 and RAID 5, uses distributed parity and disk striping. A RAID 50 drive group is a spanned drive group in which data is striped across multiple RAID 5 drive groups. RAID 50 works best with data that requires high reliability, high request rates, high data transfers, and medium-to-large capacity.



Note

You cannot have virtual drives of different RAID levels, such as RAID 0 and RAID 5, in the same drive group. For example, if an existing RAID 5 virtual drive is created out of partial space in an array, the next virtual drive in the array has to be RAID 5 only.

- RAID 60, a combination of RAID 0 and RAID 6, uses distributed parity, with two independent parity blocks per stripe in each RAID set, and disk striping. A RAID 60 virtual drive can survive the loss of two drives in each of the RAID 6 sets without losing data. It works best with data that requires high reliability, high request rates, high data transfers, and medium-to-large capacity.

RAID 0

RAID 0 provides disk striping across all drives in the RAID drive group. RAID 0 does not provide any data redundancy but does offer the best performance of any RAID level. RAID 0 breaks up data into smaller segments and stripes the data segments across each drive in the drive group. The size of each data segment is determined by the stripe size. RAID 0 offers high bandwidth.



Note

RAID level 0 is not fault tolerant. If a drive in a RAID 0 drive group fails, the whole virtual drive (all drives associated with the virtual drive) will fail.

By breaking up a large file into smaller segments, the RAID controller can use both SAS drives and SATA drives to read or write the file faster. RAID 0 involves no parity calculations to complicate the write operation, which makes RAID 0 ideal for applications that require high bandwidth, but do not require fault tolerance. [Table 1-4](#) provides an overview of RAID 0. [Figure 1-5](#) shows an example of a RAID 0 drive group advantage.

Table 1-4 RAID 0 Overview

Feature	Description
Uses	Provides high data throughput, especially for large files. Any environment that does not require fault tolerance.
Benefits	Provides increased data throughput for large files. No capacity loss penalty for parity.
Limitations	Does not provide fault tolerance or high bandwidth. All data is lost if any drive fails.
Drives	1 to 32.

Figure 1-5 RAID 0 Drive Group Example

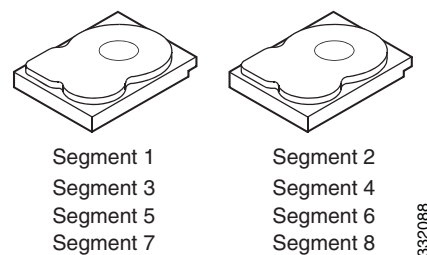

RAID 1

In RAID 1, the RAID controller duplicates all data from one drive to a second drive in the drive group. RAID 1 supports an even number of drives from 2 to 32 in a single span. RAID 1 provides complete data redundancy but at the cost of doubling the required data storage capacity. [Table 1-5](#) provides an overview of RAID 1. [Figure 1-6](#) shows an example of a RAID 1 drive group.

Table 1-5 RAID 1 Overview

Feature	Description
Uses	Use RAID 1 for small databases or any other environment that requires fault tolerance, but small capacity.
Benefits	Provides complete data redundancy. RAID 1 is ideal for any application that requires fault tolerance and minimal capacity.
Limitations	Requires twice as many drives. Performance is impaired during drive rebuilds.
Drives	2 to 32 (must be an even number of drives).

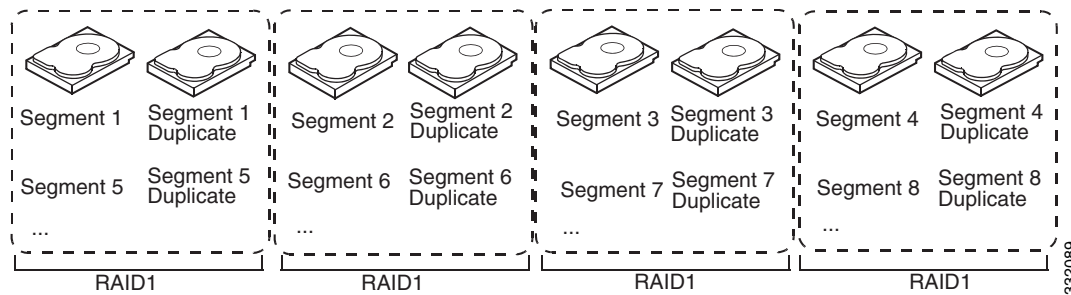
Figure 1-6 RAID 1 Drive Group Example

RAID 5

RAID 5 includes disk striping at the block level and parity. Parity is the property of the data of being odd or even, and parity checking is used to detect errors in the data. In RAID 5, the parity information is written to all drives. RAID 5 is best suited for networks that perform a lot of small input/output (I/O) transactions simultaneously. RAID 5 provides data redundancy, high read rates, and good performance in most environments. It also provides redundancy with the lowest loss of capacity.

In addition, RAID 5 is good for any application that has high read request rates but has low write request rates.

RAID 5 addresses the congestion issue for random I/O operations. Because each drive contains both data and parity, numerous writes can take place concurrently.

Table 1-6 provides an overview of RAID 5. Figure 1-7 shows an example of a RAID 5 drive group.

Table 1-6 RAID 5 Overview

Features	Description
Uses	Provides high data throughput, especially for large files. Use RAID 5 for transaction processing applications because each drive can read and write independently. If a drive fails, the RAID controller uses the parity drive to recreate all missing information. Use also for office automation and online customer service that requires fault tolerance. Use for any application that has high read request rates but low write request rates.
Benefits	Provides data redundancy, high read rates, and good performance in most environments. RAID 5 provides redundancy with the lowest loss of capacity.
Limitations	Not well-suited to tasks that require a large number of writes. RAID 5 has problems if no cache is used (clustering). The drive's performance is reduced if a drive is being rebuilt. Environments with few processes do not perform as well because the RAID overhead is not offset by the performance gains in handling simultaneous processes.
Drives	3 to 32.

**Note**

Parity is distributed across all drives in the drive group.

Figure 1-7 RAID 5 Drive Group Example

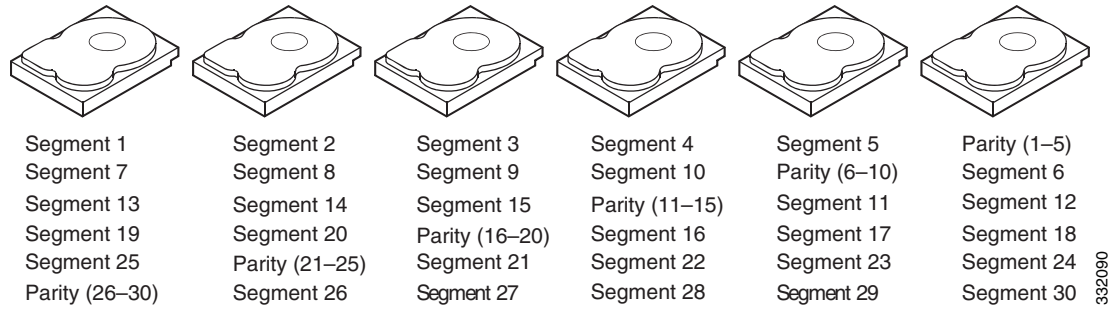

332090

RAID 6

RAID 6 is similar to RAID 5 (disk striping and distributed parity), except that instead of one parity block per stripe, there are two. With two independent parity blocks, RAID 6 can survive the loss of two drives in a virtual drive without losing data. RAID 6 provides a high level of data protection through the use of a second parity block in each stripe. Use RAID 6 for data that requires a very high level of protection from loss.

RAID 6 is best suited for networks that perform a lot of small input/output (I/O) transactions simultaneously. It provides data redundancy, high read rates, and good performance in most environments.

In the case of a failure of one drive or two drives in a virtual drive, the RAID controller uses the parity blocks to recreate all of the missing information. If two drives in a RAID 6 virtual drive fail, two drive rebuilds are required, one for each drive. These rebuilds do not occur at the same time. The controller rebuilds one failed drive and then the other failed drive.

Table 1-7 provides an overview of a RAID 6 drive group. Figure 1-8 shows a RAID 6 data layout. The second set of parity drives are denoted by Q. The P drives follow the RAID 5 parity scheme.

Table 1-7 RAID 6 Overview

Features	Description
Uses	Use for office automation and online customer service that requires fault tolerance. Use for any application that has high read request rates but low write request rates.
Benefits	Provides data redundancy, high read rates, and good performance in most environments, can survive the loss of two drives or the loss of a drive while another drive is being rebuilt, and provides the highest level of protection against drive failures of all of the RAID levels. The read performance is similar to that of RAID 5.
Limitations	Not well-suited to tasks that require a large number of writes. A RAID 6 virtual drive has to generate two sets of parity data for each write operation, which results in a significant decrease in performance during writes. The drive performance is reduced during a drive rebuild. Environments with few processes do not perform as well, because the RAID overhead is not offset by the performance gains in handling simultaneous processes. RAID 6 costs more because of the extra capacity required by using two parity blocks per stripe.
Drives	3 to 32.

Note

Parity is distributed across all drives in the drive group.

Figure 1-8 RAID 6 Drive Group Example

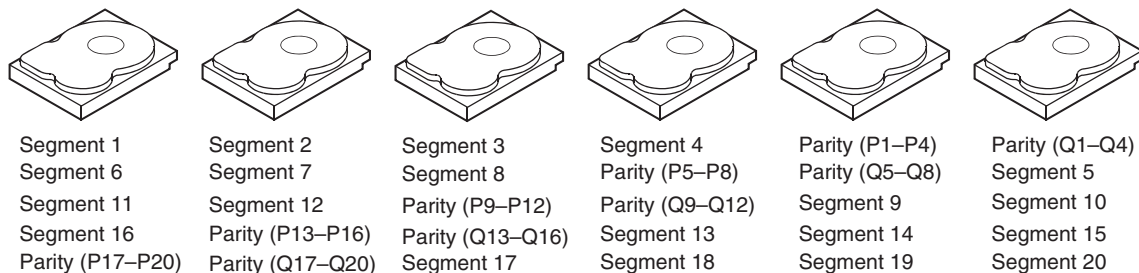

332094

RAID 00

A RAID 00 drive group is a spanned drive group that creates a striped set from a series of RAID 0 drive groups. RAID 00 does not provide any data redundancy, but along with RAID 0, RAID 00 offers the best performance of any RAID level. RAID 00 breaks up data into smaller segments and stripes the data segments across each drive in the drive groups. The size of each data segment is determined by the stripe size. RAID 00 offers high bandwidth.

Note

RAID level 00 is not fault tolerant. If a drive in a RAID 0 drive group fails, the whole virtual drive (all drives associated with the virtual drive) fails.

By breaking up a large file into smaller segments, the RAID controller can use both SAS drives and SATA drives to read or write the file faster. RAID 00 involves no parity calculations to complicate the write operation, which makes RAID 00 ideal for applications that require high bandwidth but do not require fault tolerance. [Table 1-8](#) provides an overview of RAID 00. [Figure 1-9](#) shows an example of a RAID 00 drive group.

Table 1-8 RAID 00 Overview

Features	Description
Uses	Provides high data throughput, especially for large files. Use RAID 00 in any environment that does not require fault tolerance.
Benefits	Provides increased data throughput for large files. RAID 00 has no capacity loss penalty for parity.
Limitations	Does not provide fault tolerance or high bandwidth. All data is lost if any drive fails.
Drives	2 to 256.

Figure 1-9 RAID 00 Drive Group Example Using Two Drives

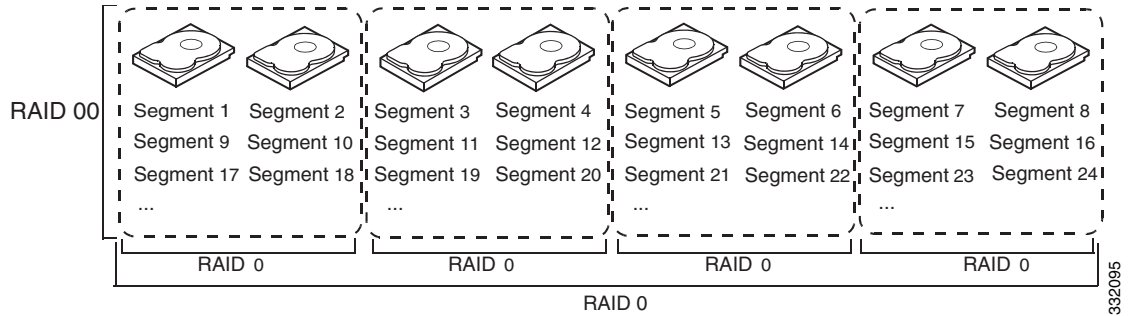

RAID 10

RAID 10 is a combination of RAID 0 and RAID 1 and consists of stripes across mirrored drives. RAID 10 breaks up data into smaller blocks and mirrors the blocks of data to each RAID 1 drive group. The first RAID 1 drive in each drive group then duplicates its data to the second drive. The size of each block is determined by the stripe size parameter, which is set during the creation of the RAID set. The RAID 1 virtual drives must have the same stripe size.

Spanning is used because one virtual drive is defined across more than one drive group. Virtual drives defined across multiple RAID 1 level drive groups are referred to as RAID level 10, (1+0). Data is striped across drive groups to increase performance by enabling access to multiple drive groups simultaneously.

Each spanned RAID 10 virtual drive can tolerate multiple drive failures, as long as each failure is in a separate drive group. If there are drive failures, less than the total drive capacity is available.

Configure RAID 10 by spanning two contiguous RAID 1 virtual drives, up to the maximum number of supported devices for the controller. RAID 10 supports a maximum of eight spans with a maximum of 32 drives per span. You must use an even number of drives in each RAID 10 virtual drive in the span.



Note

Other factors, such as the type of controller, can restrict the number of drives supported by RAID 10 virtual drives.

Table 1-9 provides an overview of RAID 10. In Figure 1-10, virtual drive 0 is created by distributing data across four RAID 1 drive groups (drive groups 0 through 3).

Table 1-9 RAID 10 Overview

Benefits	Description
Uses	Appropriate when used with data storage that needs 100 percent redundancy of mirrored drive groups and that also needs the enhanced I/O performance of RAID 0 (striped drive groups.) RAID 10 works well for medium-sized databases or any environment that requires a higher degree of fault tolerance and moderate to medium capacity.
Benefits	Provides both high data transfer rates and complete data redundancy.
Limitations	Requires twice as many drives as all other RAID levels except RAID 1.
Drives	4—The maximum number of drives supported by the controller (using an even number of drives in each RAID 10 virtual drive in the span).

Figure 1-10 RAID 10 Virtual Drive Example

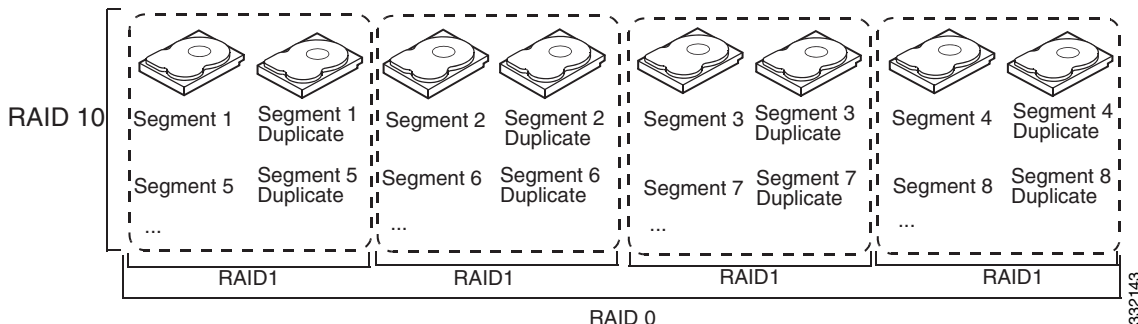

RAID 50

RAID 50 provides the features of both RAID 0 and RAID 5. RAID 50 includes both parity and disk striping across multiple drive groups. RAID 50 is best implemented on two RAID 5 drive groups with data striped across both drive groups.

RAID 50 breaks up data into smaller blocks and stripes the blocks of data to each RAID 5 disk set. RAID 5 breaks up data into smaller blocks, calculates parity, and writes the blocks of data and parity to each drive in the drive group. The size of each block is determined by the stripe size parameter, which is set during the creation of the RAIDset.

RAID level 50 can support up to eight spans and tolerate up to eight drive failures though less than total drive capacity is available. Though multiple drive failures can be tolerated, only one drive failure can be tolerated in each RAID 5 level drive group.

Table 1-10 provides an overview of RAID 50. In Figure 1-11, virtual drive 0 is created by distributing data across two RAID 5 drive groups.

Table 1-10 RAID 50 Overview

Features	Description
Uses	Appropriate when used with data that requires high reliability, high request rates, high data transfer, and medium to large capacity.
Benefits	Provides high data throughput, data redundancy, and very good performance.
Limitations	Requires 2 to 8 times as many parity drives as RAID 5.
Drives	Eight spans of RAID 5 drive groups containing 3 to 32 drives each (limited by the maximum number of devices supported by the controller).

Figure 1-11 RAID 50 Virtual Drive Example

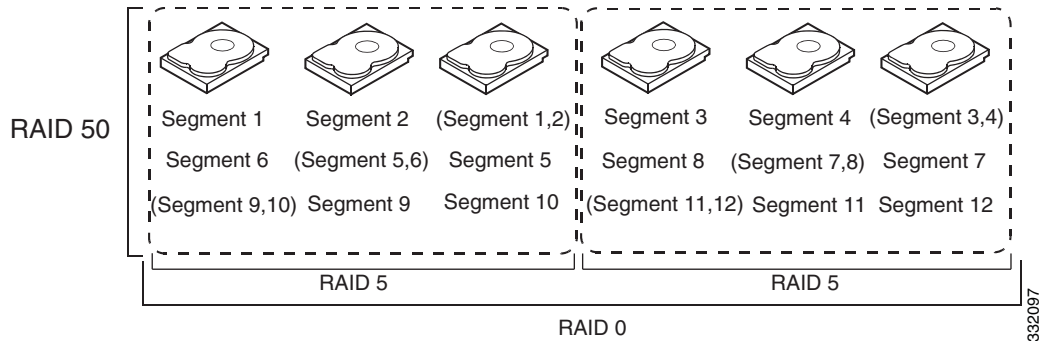

332097

RAID 60

RAID 60 provides the features of both RAID 0 and RAID 6 and includes both parity and disk striping across multiple drive groups. RAID 6 supports two independent parity blocks per stripe. A RAID 60 virtual drive can survive the loss of two drives in each of the RAID 6 sets without losing data. RAID 60 is best implemented on two RAID 6 drive groups with data striped across both drive groups.

RAID 60 breaks up data into smaller blocks and stripes the blocks of data to each RAID 6 disk set. RAID 6 breaks up data into smaller blocks, calculates parity, and writes the blocks of data and parity to each drive in the drive group. The size of each block is determined by the stripe size parameter, which is set during the creation of the RAID set.

RAID 60 can support up to 8 spans and tolerate up to 16 drive failures though less than total drive capacity is available. Two drive failures can be tolerated in each RAID 6 level drive group.

Table 1-11 provides an overview of RAID 60. Figure 1-12 shows a RAID 6 data layout. The second set of parity drives are denoted by Q. The P drives follow the RAID 5 parity scheme.

Table 1-11 RAID 60 Overview

Features	Description
Uses	<p>Provides a high level of data protection through the use of a second parity block in each stripe. Use RAID 60 for data that requires a very high level of protection from loss.</p> <p>In the case of a failure of one drive or two drives in a RAID set in a virtual drive, the RAID controller uses the parity blocks to recreate all of the missing information. If two drives in a RAID 6 set in a RAID 60 virtual drive fail, two drive rebuilds are required, one for each drive. These rebuilds can occur at the same time.</p> <p>Use for office automation and online customer service that requires fault tolerance. Use for any application that has high read request rates but low write request rates.</p>
Benefits	<p>Provides data redundancy, high read rates, and good performance in most environments. Each RAID 6 set can survive the loss of two drives or the loss of a drive while another drive is being rebuilt. RAID 60 provides the highest level of protection against drive failures of all of the RAID levels. The read performance is similar to that of RAID 50, though random reads in RAID 60 might be slightly faster because data is spread across at least one more disk in each RAID 6 set.</p>

Table 1-11 RAID 60 Overview (continued)

Features	Description
Limitations	Not well suited to tasks using many writes. A RAID 60 virtual drive has to generate two sets of parity data for each write operation, which results in a significant decrease in performance during writes. Drive performance is reduced during a drive rebuild. Environments with few processes do not perform as well because the RAID overhead is not offset by the performance gains in handling simultaneous processes. RAID 6 costs more because of the extra capacity required by using two parity blocks per stripe.
Drives	A minimum of 8.

**Note**

Parity is distributed across all drives in the drive group.

Figure 1-12 RAID 60 Virtual Drive Example

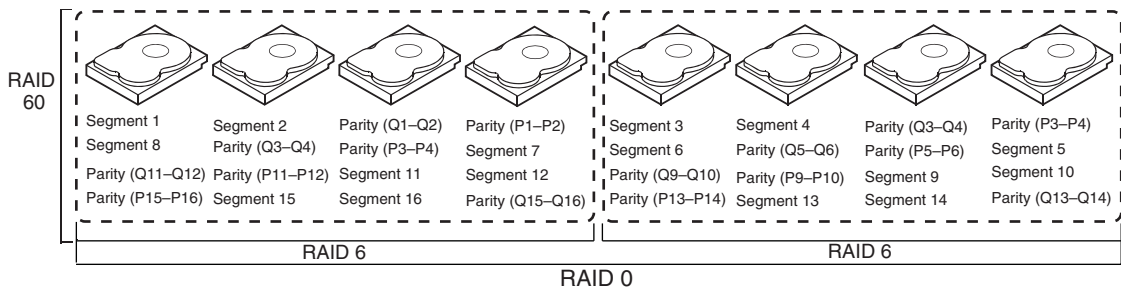

Fault Tolerance

Fault tolerance is the capability of the subsystem to undergo a drive failure or failures without compromising data integrity and processing capability. The RAID controller provides this support through redundant drive groups in RAID levels 1, 5, 6, 10, 50, and 60. The system can operate properly even with a drive failure in a drive group, although performance might be degraded to some extent.

- A RAID 1 drive group has two drives and can tolerate one drive failure.
- A RAID 5 drive group can tolerate one drive failure in each RAID 5 drive group.
- A RAID 6 drive group can tolerate up to two drive failures.
- Each spanned RAID 10 virtual drive can tolerate multiple drive failures as long as each failure is in a separate drive group.
- A RAID 50 virtual drive can tolerate two drive failures as long as each failure is in a separate drive group.
- RAID 60 drive groups can tolerate up to two drive failures in each drive group.

**Note**

RAID level 0 is not fault tolerant. If a drive in a RAID 0 drive group fails, the whole virtual drive (all drives associated with the virtual drive) fails.

Fault tolerance is often associated with system availability because it allows the system to be available during the failures. However, it is also important for the system to be available during the repair of the problem.

Hot spares are important in fault tolerance; see [Hot Spares, page 1-4](#) for more information.

Auto-rebuild allows a failed drive to be replaced and the data automatically rebuilt by hot swapping the drive in the same drive bay. See [Hot Swap, page 1-6](#) for more information. The RAID drive group continues to handle requests while the rebuild occurs.

Generic Drive Replacement Procedure

**Note**

B-series blade servers are shown but the mechanical features (release button, eject lever) are the same for most B-series and C-series servers.

Removing a Drive from a Server

- Step 1** Push the button to release the ejector, fully extend the ejection lever and then pull the hard drive from its slot. See [Figure 1-13](#).

Figure 1-13 Removing the Drive

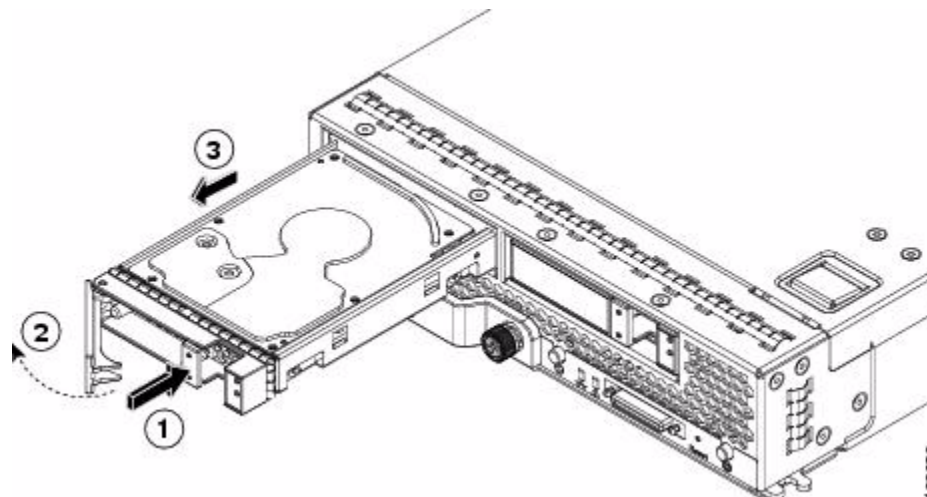

- Step 2** Place the hard drive on an antistatic mat or antistatic foam if you are not immediately reinstalling it in another blade server.
- Step 3** Install a blank faceplate (N20-BBLKD) to keep dust out of the server if the slot will remain empty.

Installing a Drive in a Server

- Step 1** Place the hard drive lever into the open position by pushing the release button (see Figure 1-14).

Figure 1-14 Installing a Hard Drive in a Blade Server

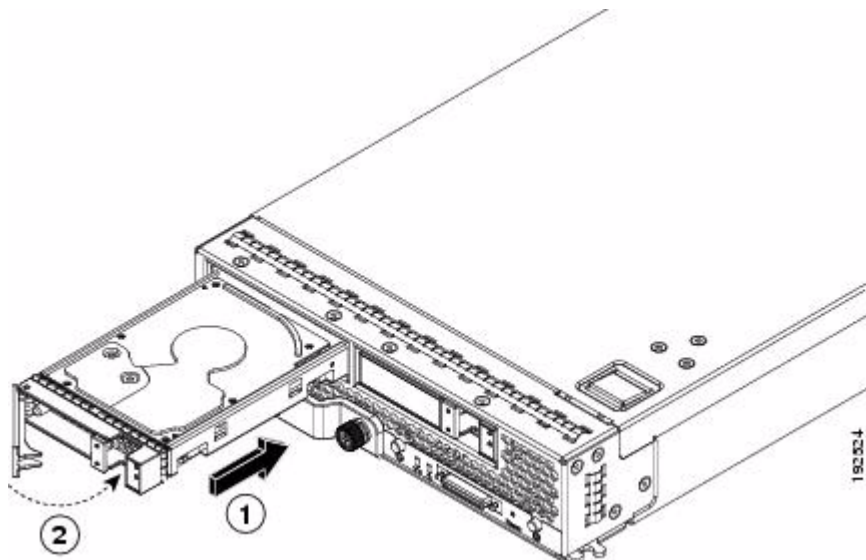

- Step 2** Gently slide the hard drive into the opening in the blade server until it seats into place.
- Step 3** Push the hard drive lever into the closed position.

If you need to move a RAID cluster, see the Moving a RAID Cluster section of the “Troubleshooting Server Hardware” chapter of the *Cisco UCS Troubleshooting Guide*.

Platform-Specific RAID and Drive Procedures

B-series RAID and supported drive information that was previously in the software configuration, hardware installation and service, and troubleshooting guides is repeated in this guide. B series servers all have onboard RAID controllers that cannot be removed or upgraded. Only software configuration and drive operations appropriate for that server’s controller are possible.

Supported RAID controllers for all models are listed in [RAID Controllers in UCS Servers, page 3-10](#).

The C-Series hardware installation guides each have a “RAID Considerations” appendix that provides information about supported RAID controllers and cables, plus cabling instructions specific to each server model. See that documentation as needed at:

http://www.cisco.com/en/US/products/ps10493/prod_installation_guides_list.html



CHAPTER 2

Using Cisco Integrated Management Controller and Cisco UCS Server Configuration Utility for RAID Monitoring and Configuring

This chapter provides information about monitoring and configuring your RAID controller in your Cisco Integrated Management Controller (CIMC) and Cisco UCS Server Configuration Utility. The Cisco C-Series servers have built-in monitoring and configuration tools for storage, including RAID.

This chapter contains the following sections:

- [Cisco Integrated Management Controller—Viewing Storage Properties, page 2-1](#)
- [Cisco UCS Server Configuration Utility—RAID Configuration, page 2-2](#)



Note

The tools and software referred to in this chapter are used only in C-series rack-mounted servers that are not integrated with Cisco UCS Manager.

Cisco Integrated Management Controller—Viewing Storage Properties

CIMC is the management service for the C-Series servers and runs within the server.

You can use a web-based GUI or Secure Shell-based CLI to access, configure, administer, and monitor the server. Almost all tasks can be performed in either interface, and the results of tasks performed in one interface are displayed in another.

The configuration information for CIMC is located in the *Cisco UCS C-Series Rack-Mount Servers Configuration Guide* and the *Cisco UCS C-Series Rack-Mount Servers CLI Configuration Guide*. For details, see the guide that applies to the release that you are using.

A complete list of GUI and CLI configuration guides can be found here: [Cisco UCS C-Series Configuration Guides](#).

The following information is included:

- Storage adapters—including all MegaRAID and Cisco Flexible Flash controllers.
- Controller information—that include the following:
 - PCI information
 - Manufacturing information

- Running and startup firmware image information
- Virtual and physical drive counts
- General settings
- Capabilities
- Hardware configuration
- Error counters
- Physical drive information—Including general drive information, identification information, and drive status.
- Virtual drive information—Including general drive information, RAID information, and physical drive information.
- Battery backup unit information (does not apply to Cisco Flexible Flash).

Cisco UCS Server Configuration Utility—RAID Configuration

You can use the RAID Configuration section in the Cisco UCS Server Configuration Utility document to configure your system RAID controllers.

RAID levels supported by SCU are RAID 0, 1, 5, and 6.

The latest documentation can be found here: [Cisco UCS Server Configuration Utility, Release 3.0 User Guide](#).

If your system has multiple RAID controllers, Cisco UCS Server Configuration Utility displays a list of all available RAID devices. This feature is described in the Server Configuration section.

Three types of RAID configurations can be set up using Cisco UCS Server Configuration Utility. This feature is documented in the RAID configuration section.

- Automatic setup with redundancy
- Automatic setup without redundancy
- Create custom or multiple RAID arrays



CHAPTER 3

Using Cisco UCS Manager for RAID Configuring and Monitoring

This chapter describes monitoring and configuring your RAID controller using Cisco UCS Manager. The Cisco B-Series servers have built-in monitoring and configuration tools for storage, including RAID.

This chapter contains the following sections:

- [Cisco UCS Manager Configuration, page 3-1](#)
- [Server Disk Drive Monitoring, page 3-7](#)
- [RAID Controllers in UCS Servers, page 3-10](#)



Note

Cisco UCS Manager is used both with B-series blade servers and C-series rack servers that have been integrated.

Cisco UCS Manager Configuration

Cisco UCS Manager interfaces with the LSI controllers and software and creates RAID configurations as part of creating local disk configuration policies, which allow the same configuration steps to be applied to many servers at once.

Local Disk Configuration Policy

This policy configures any optional SAS local drives that have been installed on a server through the onboard RAID controller of the local drive. This policy enables you to set a local disk mode for all servers that are associated with a service profile that includes the local disk configuration policy.

The local disk modes include the following:

- **No Local Storage**—For a diskless server or a SAN-only configuration. If you select this option, you cannot associate any service profile that uses this policy with a server that has a local disk.
- **RAID 0 Striped**—Data is striped across all disks in the array, providing fast throughput. There is no data redundancy, and all data is lost if any disk fails.
- **RAID 1 Mirrored**—Data is written to two disks, which provides complete data redundancy if one disk fails. The maximum array size is equal to the available space on the smaller of the two drives.
- **Any Configuration**—For a server configuration that carries forward the local disk configuration without any changes.

- No RAID—For a server configuration that removes the RAID and leaves the disk MBR and payload unaltered.
- RAID 5 Striped Parity—Data is striped across all disks in the array. Part of the capacity of each disk stores parity information that can be used to reconstruct data if a disk fails. RAID 5 provides good data throughput for applications with high read request rates.
- RAID 6 Striped Dual Parity—Data is striped across all disks in the array, and two parity disks are used to provide protection against the failure of up to two physical disks. In each row of data blocks, two sets of parity data are stored.
- RAID10 Mirrored and Striped— RAID 10 uses mirrored pairs of disks to provide complete data redundancy and high throughput rates.

You must include this policy in a service profile, and that service profile must be associated with a server for the policy to take effect.

Guidelines for all Local Disk Configuration Policies

Before you create a local disk configuration policy, consider the following guidelines:

- No Mixed HDDs and SSDs
Mixing HDD and SSDs in a single server or RAID configuration is not supported.
- Do Not Assign a Service Profile with the Default Local Disk Configuration Policy from a B200 M1 or M2 to a B200 M3
Due to the differences in the RAID/JBOD support provided by the storage controllers of B200 M1 and M2 servers and those of the B200 M3 server, you cannot assign or reassign a service profile that includes the default local disk configuration policy from a B200M1 or M2 server to a B200 M3 server. The default local disk configuration policy includes the Any Configuration or JBOD modes.
- Impact of Upgrade to Release 1.3(1i) or Higher

An upgrade from an earlier Cisco UCS firmware release to release 1.3(1i) or higher has the following impact on the Protect Configuration property of the local disk configuration policy the first time servers are associated with service profiles after the upgrade:

- Unassociated Servers
After you upgrade the Cisco UCS domain, the initial server association proceeds without configuration errors whether or not the local disk configuration policy matches the server hardware. Even if you enable the Protect Configuration property, Cisco UCS does not protect the user data on the server if there are configuration mismatches between the local disk configuration policy on the previous service profile and the policy in the new service profile.



Note If you enable the Protect Configuration property and the local disk configuration policy encounters mismatches between the previous service profile and the new service profile, all subsequent service profile associations with the server are blocked.

- Associated Servers
Any servers that are already associated with service profiles do not reboot after the upgrade. Cisco UCS Manager does not report any configuration errors if there is a mismatch between the local disk configuration policy and the server hardware.

When a service profile is disassociated from a server and a new service profile associated, the setting for the Protect Configuration property in the new service profile takes precedence and overwrites the setting in the previous service profile.

Guidelines for Local Disk Configuration Policies Configured for RAID

- No Mixed HDDs and SSDs

Do not include HDDs and SSDs in a single RAID configuration.

- Do Not Use the Any Configuration Mode on Servers with MegaRAID Storage Controllers

If a blade server or rack-mount server in a Cisco UCS domain includes a MegaRAID storage controller, do not configure the local disk configuration policy in the service profile for that server with the Any Configuration mode. If you use this mode for servers with a MegaRAID storage controller, the installer for the operating system cannot detect any local storage on the server.

If you want to install an operating system on local storage on a server with a MegaRAID storage controller, you must configure the local disk configuration policy with a mode that creates a RAID LUN (Logical Unit Number) for that volume on the server.

- Server May Not Boot After RAID 1 Cluster Migration if Any Configuration Mode Specified in Service Profile

After RAID 1 clusters are migrated, you must associate a service profile with the server. If the local disk configuration policy in the service profile is configured with Any Configuration mode rather than RAID 1, the RAID LUN remains in an “inactive” state during and after association. As a result, the server cannot boot.

To avoid this issue, ensure that the service profile you associate with the server contains the identical local disk configuration policy as the original service profile before the migration and does not include the Any Configuration mode.

- Configure RAID Settings in Local Disk Configuration Policy for Servers with MegaRAID Storage Controllers

If a blade server or integrated rack-mount server has a MegaRAID controller, you must configure RAID settings for the drives in the Local Disk Configuration policy included in the service profile for that server.

If you do not configure your RAID LUNs before installing the OS, disk discovery failures might occur during the installation and you might see error messages such as “No Device Found.”

- Do Not Use JBOD Mode on Servers with MegaRAID Storage Controllers

Do not configure or use JBOD mode or JBOD operations on any blade server or integrated rack-mount server with MegaRAID storage controllers. JBOD mode and operations are not supported on these servers.

- Maximum of One RAID Volume and One RAID Controller in Integrated Rack-Mount Servers

A rack-mount server that has been integrated with Cisco UCS Manager can have a maximum of one RAID volume irrespective of how many hard drives are present on the server.

All the local hard drives in an integrated rack-mount server must be connected to only one RAID controller. Integration with Cisco UCS Manager does not support the connection of local hard drives to multiple RAID controllers in a single rack-mount server. We therefore recommend that you request a single RAID controller configuration when you order rack-mount servers to be integrated with Cisco UCS Manager.

In addition, do not use third-party tools to create multiple RAID LUNs on rack-mount servers. Cisco UCS Manager does not support that configuration.

- Maximum of One RAID Volume and One RAID Controller in Blade Servers

A blade server can have a maximum of one RAID volume irrespective of how many drives are present in the server. All the local hard drives must be connected to only one RAID controller. For example, a B200 M3 server has an LSI controller and an Intel Patsburg controller, but only the LSI controller can be used as a RAID controller.

In addition, do not use third-party tools to create multiple RAID LUNs on blade servers. Cisco UCS Manager does not support that configuration.

- Number of Disks Selected in Mirrored RAID Should Not Exceed Two

If the number of disks selected in the Mirrored RAID exceed two, RAID 1 is created as a RAID 10 LUN. This issue can occur with the Cisco UCS B440 M1 and B440 M2 servers.

Creating a Local Disk Configuration Policy

-
- Step 1** In the Navigation pane, click the **Servers** tab.
- Step 2** On the **Servers** tab, expand **Servers > Policies**.
- Step 3** Expand the node for the organization where you want to create the policy.
If the system does not include multi-tenancy, expand the **root** node.
- Step 4** Right-click **Local Disk Config Policies** and choose **Create Local Disk Configuration Policy**.
- Step 5** In the **Create Local Disk Configuration Policy** dialog box, complete the following fields:

Name	Description
Name field	<p>The name of the policy.</p> <p>This name can be between 1 and 16 alphanumeric characters. You cannot use spaces or any special characters other than - (hyphen), _ (underscore), : (colon), and . (period), and you cannot change this name after the object has been saved.</p>
Description field	<p>A description of the policy. We recommend that you include information about where and when the policy should be used.</p> <p>Enter up to 256 characters. You can use any characters or spaces except ^ (carat), \ (back slash), > (greater than), < (less than), ' (single quote), " (double quote), ` (accent mark), or = (equal sign).</p>

Name	Description
Mode drop-down list	<p>This can be one of the following local disk policy modes:</p> <ul style="list-style-type: none"> • No Local Storage—For a diskless server or a SAN-only configuration. If you select this option, you cannot associate any service profile which uses this policy with a server that has a local disk. • RAID 0 Striped—Data is striped across all disks in the array, providing fast throughput. There is no data redundancy, and all data is lost if any disk fails. • RAID 1 Mirrored—Data is written to two disks, which provides complete data redundancy if one disk fails. The maximum array size is equal to the available space on the smaller of the two drives. • Any Configuration—For a server configuration that carries forward the local disk configuration without any changes. • No RAID—For a server configuration that removes the RAID and leaves the disk MBR and payload unaltered. • RAID 5 Striped Parity—Data is striped across all disks in the array. Part of the capacity of each disk stores parity information that can be used to reconstruct data if a disk fails. RAID 5 provides good data throughput for applications with high read request rates. • RAID 6 Striped Dual Parity—Data is striped across all disks in the array and two parity disks are used to provide protection against the failure of up to two physical disks. In each row of data blocks, two sets of parity data are stored. • RAID10 Mirrored and Striped— RAID 10 uses mirrored pairs of disks to provide complete data redundancy and high throughput rates. <p>Note If you choose No RAID and you apply this policy to a server that already has an operating system with RAID storage configured, the system does not remove the disk contents. Therefore, there may be no visible differences after you apply the No RAID mode.</p> <p>To make sure that any previous RAID configuration information is removed from a disk, apply a scrub policy that removes all disk information after you apply the No RAID configuration mode.</p>

Name	Description
Protect Configuration check box	If checked, the server retains the configuration in the local disk configuration policy even if the server is disassociated from the service profile.
	
Caution	Protect Configuration becomes non functional if one or more disks in the server are defective or faulty.
	This property is checked by default.
	When a service profile is disassociated from a server and a new service profile associated, the setting for the Protect Configuration property in the new service profile takes precedence and overwrites the setting in the previous service profile.
Note	If you disassociate the server from a service profile with this option enabled and then associate it with a new service profile that includes a local disk configuration policy with different properties, the server returns a configuration mismatch error and the association fails.

Step 6 Click OK.

Changing a Local Disk Configuration Policy

This procedure describes how to change a local disk configuration policy from an associated service profile. You can also change a local disk configuration policy from the Policies node of the Servers tab.

- Step 1** In the Navigation pane, click the **Servers** tab.
- Step 2** On the **Servers** tab, expand **Servers > Service Profiles**.
- Step 3** Expand the organization that includes the service profile with the local disk configuration policy you want to change.
- If the system does not include multi-tenancy, expand the **root** node.
- Step 4** Click the service profile that contains the local disk configuration policy you want to change.
- Step 5** In the Work pane, click the **Policies** tab.
- Step 6** In the **Actions** area, click **Change Local Disk Configuration Policy**.
- Step 7** In the **Change Local Disk Configuration Policy** dialog box, choose one of the following options from the **Select the Local Disk Configuration Policy** drop-down list.

Option	Description
Use a Disk Policy	Select an existing local disk configuration policy from the list below this option. Cisco UCS Manager assigns this policy to the service profile.

Option	Description
Create a Local Disk Policy	Enables you to create a local disk configuration policy that can only be accessed by the selected service profile.
No Disk Policy	Does not use a local disk configuration policy for the selected service profile.

Step 8 Click **OK**.

Step 9 (Optional) Expand the Local Disk Configuration Policy area to confirm that the change has been made.

Deleting a Local Disk Configuration Policy

Step 1 In the Navigation pane, click the **Servers** tab.

Step 2 On the **Servers** tab, expand **Servers > Policies > Organization_Name**.

Step 3 Expand the **Local Disk Config Policies** node.

Step 4 Right-click the policy you want to delete and choose **Delete**.

Step 5 If the Cisco UCS Manager GUI displays a confirmation dialog box, click **Yes**.

Server Disk Drive Monitoring

The disk drive monitoring for Cisco UCS provides Cisco UCS Manager with blade-resident disk drive status for supported blade servers in a Cisco UCS domain. Disk drive monitoring provides a unidirectional fault signal from the LSI firmware to Cisco UCS Manager to provide status information.

The following server and firmware components gather, send, and aggregate information about the disk drive status in a server:

- Physical presence sensor—Determines whether the disk drive is inserted in the server drive bay.
- Physical fault sensor—Determines the operability status reported by the LSI storage controller firmware for the disk drive.
- IPMI disk drive fault and presence sensors—Sends the sensor results to Cisco UCS Manager.
- Disk drive fault LED control and associated IPMI sensors—Controls disk drive fault LED states (on/off) and relays the states to Cisco UCS Manager.

Support for Disk Drive Monitoring

Disk drive monitoring only supports certain blade servers and a specific LSI storage controller firmware level.

Through Cisco UCS Manager, you can monitor disk drives for the following servers:

- B200 blade server
- B230 blade server

- B250 blade server
- B440 blade server

Cisco UCS Manager cannot monitor disk drives in any other blade server or rack-mount server.

The storage controller on a supported server must have LSI firmware.

Cisco UCS Manager cannot disk drives in servers with a different version of the storage controller firmware.

In addition to the supported servers and storage controller firmware version, you must ensure that the following prerequisites have been met for disk drive monitoring to provide useful status information:

- The drive must be inserted in the server drive bay.
- The server must be powered on.
- The server must have completed discovery.
- The results of the BIOS POST complete must be TRUE.

Viewing the Status of a Disk Drive

- Step 1** In the Navigation pane, click the **Equipment** tab.
- Step 2** On the **Equipment** tab, expand **Equipment > Chassis > Chassis Number > Servers**.
- Step 3** Click the server for which you want to view the status of the disk drive.
- Step 4** In the **Work** pane, click the **Inventory** tab.
- Step 5** Click the **Storage** sub-tab.
- Step 6** Click the down arrows to expand the Disks bar and view the following fields in the States section for each disk drive:

Name	Description
Operability field	<p>The operational state of the disk drive, which can be one of the following:</p> <ul style="list-style-type: none"> • Operable—The disk drive is operable. • Inoperable—The disk drive is inoperable, possibly due to a hardware issue such as bad blocks. • N/A—The operability of the disk drive cannot be determined, which could be due to the server or firmware not being supported for disk drive monitoring, or because the server is powered off. <p>Note The Operability field might show the incorrect status for several reasons, such as if the disk is part of a broken RAID set or if the BIOS POST (Power On Self Test) has not completed.</p>
Presence field	<p>The presence of the disk drive, and whether it can be detected in the server drive bay, regardless of its operational state, which can be either of the following:</p> <p>Equipped—A disk drive can be detected in the server drive bay.</p> <p>Missing—No disk drive can be detected in the server drive bay.</p>

Interpreting the Status of a Monitored Disk Drive

Cisco UCS Manager displays the following properties for each monitored disk drive:

- Operability—The operational state of the disk drive.
- Presence—The presence of the disk drive, and whether it can be detected in the server drive bay, regardless of its operational state.

You need to look at both properties to determine the status of the monitored disk drive. The following table shows the likely interpretations of the property values.

Table 3-1 *Disk States*

Operability Status	Presence Status	Interpretation
Operable	Equipped	No fault condition. The disk drive is in the server and can be used.
Inoperable	Equipped	Fault condition. The disk drive is in the server, but one of the following could be causing an operability problem: <ul style="list-style-type: none"> The disk drive is unusable due to a hardware issue such as bad blocks. There is a problem with the IPMI link to the storage controller.
N/A	Missing	Fault condition. The server drive bay does not contain a disk drive.
N/A	Equipped	Fault condition. The disk drive is in the server, but one of the following could be causing an operability problem: <ul style="list-style-type: none"> The server is powered off. The storage controller firmware is the wrong version and does not support disk drive monitoring. The server does not support disk drive monitoring.

**Note**

The Operability field might show the incorrect status for several reasons, such as if the disk is part of a broken RAID set or if the BIOS POST (Power On Self Test) has not completed.

RAID Controllers in UCS Servers

Table 3-2 *C-Series RAID Controllers*

Server Model	Onboard Controller	Integrated Controller	MegaRAID Controller
C200 LFF	Intel ICH10R	LSI 1064E	LSI MR 9260-4i LSI MR 9280-4i4e
C200 SFF	Intel ICH10R	LSI 1068E	LSI MR 9260-8i LSI MR 9280-4i4e
C210	Intel ICH10R	LSI 1064E	LSI MR 9280-4i4e LSI MR 9261-8i
C250	—	LSI SAS 3081E-R	LSI MR 9261-8i
C260	—	—	LSI MR 9261-8i
C460	—	—	LSI MR 9240-8i LSI MR 9260-8i

Table 3-2 C-Series RAID Controllers

Server Model	Onboard Controller	Integrated Controller	MegaRAID Controller
C220	Embedded MegaRAID	Cisco SAS 2008M-8i	LSI MR 9266-8i LSI MR SAS 9266CV-8i LSI MR 9285CV-8e
C240	Embedded MegaRAID	Cisco SAS 2008M-8i	LSI MR 9266-8i LSI MR SAS 9266CV-8i LSI MR 9285CV-8e

All B-series servers use a fixed onboard controller that is not field replaceable. The controller uses the same integrated SAS or MegaRAID firmware as the C-series servers, but except as noted, configuration and other software tasks are done using Cisco UCS Manager. [Table 3-3](#) shows the B-series RAID Controllers

Table 3-3 B-Series RAID Controllers

Server Model	SAS Controller	MegaRAID Controller
B200 (M1 and M2)	LSI 1064E	—
B200 M3	LSI SAS 2004	—
B230	—	LSI SAS 2008 (onboard version of the LSI MegaRAID 9240) Note This server model only has 2 disks
B250 (M1 and M2)	LSI 1064E	—
B440	—	LSI SAS 2108 (onboard version of the LSI MegaRAID 9260)
B22	LSI SAS 2002	—

Determining Which Controller is in Your Server

You can use the Cisco UCS Manager GUI Inventory tab to determine which controller is installed in a server. CIMC has a similar functionality.

If you do not have a record of which device is used in the server, you can read the on-screen messages that are displayed during system bootup. These messages display information about the devices that are installed in your server.

- Information about the models of card installed are displayed as part of the verbose boot. You are also prompted to press **Ctrl-H** to launch configuration utilities for those cards. For servers running CIMC firmware earlier than release 1.2(1), see also [Disabling Quiet Boot for CIMC Firmware Earlier than Release 1.2\(1\)](#), page 4-24.
- If a mezzanine-style card is enabled, you are prompted to press **Ctrl-C** to launch the configuration for these cards.
- If no models of card are displayed but there is a RAID configuration, your server is using the onboard ICH10R controller. You are also prompted to press **Ctrl-M** to launch the configuration utilities for this controller.

Figure 3-1 ICH10R Launch Window

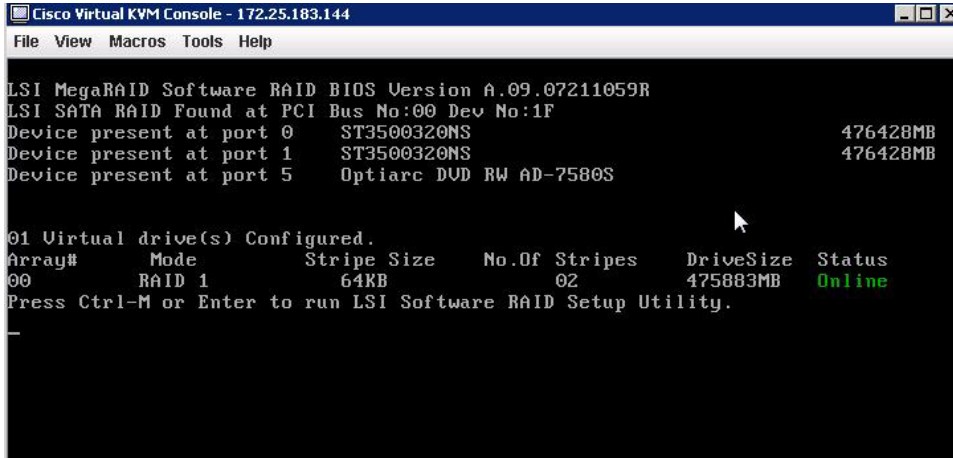

```

Cisco Virtual KVM Console - 172.25.183.144
File View Macros Tools Help

LSI MegaRAID Software RAID BIOS Version A.09.07211059R
LSI SATA RAID Found at PCI Bus No:00 Dev No:1F
Device present at port 0      ST3500320NS      476428MB
Device present at port 1      ST3500320NS      476428MB
Device present at port 5      Optiarc DVD RW AD-7580S

01 Virtual drive(s) Configured.
Array#   Mode      Stripe Size   No.Of Stripes   DriveSize   Status
00       RAID 1      64KB         02              475883MB    Online
Press Ctrl-M or Enter to run LSI Software RAID Setup Utility.

```

RAID Controllers

You can order or configure the B-Series servers with the following RAID controller options:

- The Cisco UCS B200 and B250 servers have an LSI 1064E controller on the motherboard. The controller supports RAID 0 and 1 for up to two SAS or two SATA drives. The controller must be enabled in Cisco UCS Manager before configuring RAID. All RAID options can be configured from Cisco UCS Manager.
- The Cisco UCS B440 servers have the LSI MegaRAID controller (the model varies by server). Depending on the license key installed, these controllers provide RAID 0, 1, 5, 6, and 10 support for up to four SAS or SATA drives.
- The Cisco B200 M3 servers have an LSI SAS 2004 RAID controller on the motherboard. The controller supports RAID 0 and 1 for up to two SAS or two SATA drives.



Note

If you ever need to move a RAID cluster from one server to another, both the old and new servers for the cluster must use the same LSI controller. For example, migration from a server with an LSI 1064E to a server with an LSI MegaRAID is not supported.

If there is no record of which option is used in the server, disable the quiet boot feature and read the messages that appear during system boot. Information about the models of installed RAID controllers appears as part of the verbose boot feature. You are prompted to press Ctrl-H to launch configuration utilities for those controllers.

Disabling Quiet Boot

When the quiet boot feature is disabled, the controller information and the prompts for the option ROM-based LSI utilities are displayed during bootup.

- Step 1** Boot the server and watch for the F2 prompt during the boot process.
- Step 2** To enter the BIOS Setup Utility, press **F2** when prompted.
- Step 3** On the Main page of the BIOS Setup Utility, set Quiet Boot to **disabled**.

This action allows non default messages, prompts, and POST messages to display during bootup instead of the Cisco logo window.

Step 4 Press **F10** to save the changes and exit the utility.

Accessing ROM-Based Controller Utilities

To change the RAID configurations on your hard drives, use the host-based utilities that were installed on top of the host OS. You can also use the LSI option ROM-based utilities that are installed on the server.

Step 1 Boot the server with Quiet mode disabled.

Information about the controller appears along with the prompts for the key combination to launch the LSI option ROM-based utilities for your controller.

Step 2 During the verbose boot process, enter one of the following control commands when the prompt for the desired controller appears.

- When the Ctrl-H prompt appears, press **Ctrl-H** to enter the LSI controller card utility.
 - When the Ctrl-M prompt appears, press **Ctrl-M** to enter the onboard Intel ICH10R controller utility.
-

Documentation About RAID Controllers and LSI Utilities

The LSI utilities have manufacturer documentation. For non Cisco UCS-specific information on RAID and how to use the LSI utilities, see the following documentation:

- *LSI MegaRAID SAS Software User's Guide* (for LSI MegaRAID)
- *LSI Fusion-MPT Device Management User's Guide* (for LSI 3081E)
- *LSI SAS2 Integrated RAID Solution User Guide* (for LSI SAS1064E)

Moving a RAID Cluster Using UCS Software Version 1.4(1)

You can set a server to recognize a RAID cluster created on another server. This procedure is useful when upgrading from the M1 version of a server to the M2 version of a server. You can also use this procedure whenever data on a RAID cluster needs to be moved between servers.



Note

Both the old and new servers for the cluster must use the same LSI controller. For example, migration from a server with an LSI 1064E to a server with an LSI MegaRAID is not supported.

Before You Begin

Verify that the service profiles for both the source and destination servers have an identical local disk configuration policy and can boot successfully.

Step 1 Put both the start and destination servers for the RAID cluster in the associated state.

Step 2 Shut down both servers.



Note

When using this procedure during an M1 to M2 upgrade or a direct replacement within a slot, at this point in process the destination server is not yet associated and does not have a disk policy. When the destination server is inserted into the slot where the start server was located, the destination server inherits policies from the start server. The raid controller and the PnuOS reads the disk and RAID volume details during the subsequent association (when PnuOS boots).

Step 3 After the servers power off, physically move the drives in the array to the destination server. If you are changing servers but keeping the drives in the same slots, insert the new server into the slot of the original server.

Step 4 Connect the KVM dongle.

Step 5 Connect a monitor, keyboard, and mouse to the destination server.

Step 6 Boot the destination server, using the power switch on the front of the server. If necessary, disable the quiet boot feature and boot again.

Step 7 Wait for the LSI Configuration Utility banner.

Step 8 To enter the LSI Configuration Utility, press **Ctrl-C**.

Step 9 From the **SAS Adapter List** window, choose the SAS adapter used in the server.

Step 10 Choose **RAID Properties**. The **View Array** window appears.

Step 11 Choose **Manage Array**. The **Manage Array** window appears.

Step 12 Choose **Activate Array**. When the activation is complete, the RAID status changes to Optimal.

Step 13 On the **Manage Array** window, choose **Synchronize Array**.

Step 14 Wait for the mirror synchronization to complete, and monitor the progress bar that comes up.



Note

The time to complete the synchronization can vary depending upon the size of the disks in the RAID array.

Step 15 When the mirror synchronization is complete, press the **ESC** key several times to go back through each of the widows (one at a time) and then exit the LSI Configuration Utility.

Step 16 Choose the **reboot** option to implement the changes.

Moving a RAID Cluster Using UCS Software Version 1.4(2) and Later Releases

You can set a server to recognize a RAID array created on another server. This procedure is useful when upgrading from the M1 version of a server to the M2 version of a server. You can also use this procedure whenever data on a RAID array needs to be moved between servers.



Note

Both the old and new servers for the cluster must use the same LSI controller family. For example, migration between a server with an LSI 1064 to a server with an LSI MegaRAID is not supported.

Before You Begin

Verify that the service profiles for both the source and destination servers have an identical local disk configuration policy and can boot successfully.

Step 1 Decommission both the source and destination servers from Cisco UCS Manager.

Step 2 Wait for the servers to shut down (Decommission Server prompts you to shut down the server).

**Note**

When you use this procedure during an M1 to M2 upgrade or a direct replacement within a slot, at this point in the process the destination server is not yet associated and does not have a disk policy. When the destination server is inserted into the slot where the start server was located, the destination server inherits policies from the start server. The RAID controller and the PnuOS reads the disk and RAID volume details during the subsequent association (when PnuOS boots).

Step 3 After the servers power off, physically move the drives in the array to the destination server.

If you are changing servers but keeping the drives in the same slots, insert the new server into the slot of the original server.

Step 4 Power on the servers by pressing the front power button of each of the servers.

Step 5 Choose **Reacknowledge Slot** for each of the slots (Source and Destination). If Cisco UCS Manager prompts you to Resolve Slot Issue, choose the **here** link in the **Resolve Slot** window and resolve the slot issue before server discovery begins.

Step 6 Wait for server discovery and association to complete for each server.

If each of the preceding steps runs without issues, the servers boot up with the OS that was installed on the respective RAID volumes prior to the RAID Cluster Migration.

Moving a RAID Cluster Between B200 M3 Servers

You can set a server to recognize a RAID cluster created on another server. You can also use this procedure whenever data on a RAID cluster needs to be moved between servers.

Before You Begin

Verify that the service profiles for both the source and destination servers have an identical local disk configuration policy and can boot successfully.

Step 1 Shut down the source server's operating system from within that operating system.

Before proceeding, verify that the OS has shut down completely and not restarted itself.

Step 2 Disassociate the service profile currently applied to the B200M3 server.

Step 3 Physically move the drives in the array to the destination server.

If you are changing servers, you must keep the drives in the same slot in the new server as they were in the original server.

Step 4 Reassociate the service profile to the new blade, keeping the same LD Config Policies as were previously used.

- Step 5** Power on the servers by pressing the front power button of each of the servers.
 - Step 6** Open a KVM connection to the new server and wait for the Storage Web BIOS Utility.
 - Step 7** Follow the web BIOS Utility prompts to migrate the RAID LUN.
-

Replacing a Failed Drive in a RAID Cluster

We recommend that you follow the industry standard practice of using drives of the same capacity when creating RAID volumes. If you use drives of different capacities, the usable portion of the smallest drive is used on all drives that make up the RAID volume.

Before You Begin

Replace a failed HDD or SSD with a drive of the same size, model, and manufacturer. Before changing an HDD in a running system, check the service profile in Cisco UCS Manager to make sure that the new hardware configuration is within the parameters allowed by the service profile.

- Step 1** Connect the KVM dongle to the server with the failed drive.
 - Step 2** Connect a monitor, keyboard, and mouse to the destination server.
 - Step 3** Physically replace the failed drive.
If needed, refer to the service note for your server model. In general, the steps are similar for most models.
 - Step 4** Boot the server, using the power switch on the front of the server.
If necessary, disable the quiet boot feature and boot again. (See *Disabling Quiet Boot*, on page 57.)
 - Step 5** Wait for the LSI Configuration Utility banner.
 - Step 6** To enter the LSI Configuration Utility, press **Ctrl-C**.
 - Step 7** From the **SAS Adapter List** window, choose the SAS adapter used in the server.
To determine which RAID controller is being used, refer to *RAID Controllers*, on page 57.
 - Step 8** Choose **RAID Properties**.
The **View Array** window appears.
 - Step 9** Choose **Manage Array**.
The **Manage Array** window appears.
 - Step 10** Choose **Activate Array**.
When the activation is complete, the RAID status changes to Optimal.
 - Step 11** On the **Manage Array** screen, choose **Synchronize Array**.
 - Step 12** Wait for the mirror synchronization to complete, and monitor the progress bar that comes up.
-
-  **Note** The time to complete the synchronization can vary depending upon the size of the disks in the RAID array.
-
- Step 13** When the mirror synchronization is complete, press the **ESC** key several times to go back through each of the windows (one at a time) and then exit the LSI Configuration Utility.
 - Step 14** Choose the **reboot** option to implement the changes.
-



CHAPTER 4

Configuring the LSI SAS2 Integrated RAID Controller

This chapter describes the LSI Integrated RAID solution for LSI SAS2 RAID controllers.

You should use this chapter if your server has an integrated RAID controller. The supported integrated RAID controllers at this time are the LSI 1064E-based controller, the LSI 1068-based controller, and the LSI 2008-based controller.

If your server has an LSI MegaRAID SAS controller, see [Chapter 5, “LSI MegaRAID SAS Controller Tasks.”](#)

This chapter contains the following sections:

- [Information about LSI Integrated RAID, page 4-1](#)
- [Mirrored Volumes, page 4-2](#)
- [Integrated Striping, page 4-8](#)
- [Creating Mirrored Volumes, page 4-10](#)
- [Creating Integrated Striping Volumes, page 4-19](#)

Information about LSI Integrated RAID

The LSI Integrated RAID solution includes the following RAID features:

- Integrated Mirroring, which provides RAID 1 features.
- Integrated Mirroring and Striping, which provides RAID 10 features.
- Integrated Mirroring Enhanced, which provides RAID 1 Enhanced (RAID 1E) features.
- Integrated Striping, which provides RAID 0 features.

For more information, see [RAID Levels, page 1-7](#).

The LSI Fusion-MPT firmware supports Integrated Mirroring volumes, Integrated Mirroring and Striping volumes, Integrated Mirroring Enhanced volumes, and Integrated Striping volumes. You can create up to two Integrated RAID volumes on each LSI SAS2 controller.

The LSI Integrated RAID firmware uses the same device drivers as the standard LSI Fusion-MPT-based controllers, which eliminates the need for complex backup software or expensive RAID hardware. To conserve system resources, the Integrated RAID firmware operates independently from the operating system.

The LSI SAS2 BIOS Configuration Utility makes it easy to configure mirrored and striped volumes. The Integrated RAID solution is currently available as an optional component of the Fusion-MPT architecture on LSI SAS2 controllers.

The LSI Integrated RAID solution has the following features:

- Support for up to ten disks per Integrated RAID volume, with one or two volumes on each SAS2 controller. Each controller can support 14 volume drives, including one or two hot spare disks.
- Support for two-disk Integrated Mirroring volumes (RAID 1).
- Support for online capacity expansion (OCE) for RAID 1 volumes. OCE allows you to increase the size of a RAID 1 volume by replacing the disk drives with higher-capacity drives.
- RAID volume creation, which meets the needs of most internal RAID installations.
- Easy installation and configuration.
- Support for booting from any kind of Integrated RAID volume.
- Ability to operate without special operating system-specific software.
- High reliability and data integrity as follows:
 - Nonvolatile write journaling.
 - Physical disks in a volume are not visible to the operating system (OS) or to application software.
- Low host CPU and PCI bus utilization
- Processing power provided by Fusion-MPT architecture:
 - Shared-memory architecture that minimizes external memory requests.
 - Device hardware and firmware that contain the Fusion-MPT architecture functionality.

The Integrated RAID host interface uses the message-passing interface that gives the host OS access to the RAID volumes and to additional non-RAID physical disks.

The Integrated RAID firmware supports metadata, which describes the logical drive configuration stored on each member disk of a volume. After initialization, the firmware queries each member disk to read the metadata and verify the configuration. The firmware reduces the usable disk space for each member disk when it creates the volume, which makes room for the metadata.

The Self-Monitoring Analysis and Reporting Technology (SMART) monitors disk drives for signs of future disk failure and generates an alert if it detects such signs. The Integrated RAID firmware polls each physical disk in the volume at regular intervals. If the firmware detects a SMART code on a physical disk in the volume, it processes the SMART data and stores it in a log. The volume does not support SMART directly because it is only a logical representation of the physical disks in the volume.

The Integrated RAID BIOS uses the LSI Fusion-MPT interface to communicate to the SAS2 controller and firmware, which includes reading the Fusion-MPT configuration to access the parameters that define behavior between the SAS2 controller and the devices that connect to it. The Fusion-MPT drivers for all supported operating systems implement the Fusion-MPT interface to communicate with the controller and firmware.

Mirrored Volumes

The mirroring features of LSI Integrated RAID provide data protection for the system boot volume, which safeguards the operating system and other critical information on servers and high-performance workstations.

The Integrated RAID solution supports the following types of mirrored arrays:

- Integrated Mirroring, which provides RAID 1 features.
- Integrated Mirroring and Striping, which provides RAID 10 features.
- Integrated Mirroring Enhanced, which provides RAID 1 Enhanced (RAID 1E) features.

These three mirroring solutions provide a robust, high-performance, fault-tolerant solution to data storage needs at a lower cost than a dedicated RAID controller.

Mirrored volumes can have from two to ten disks to provide fault-tolerant protection for critical data. Mirrored volumes also support one or two global hot spare drives, with a maximum of 14 drives on each LSI SAS2 controller.

**Note**

Fourteen drives is the upper limit for a single LSI SAS2 controller, although the controller may support fewer than 14 drives. You can also configure one mirrored volume and one Integrated Striping volume on the same LSI SAS controller.

Each SAS2 controller can have two global hot spare disks available to automatically replace a failed disk in the one or two mirrored volumes configured on the controller. The hot spares make the mirrored volumes even more fault tolerant.

Operation of Mirrored Volumes

LSI Integrated RAID supports one or two mirrored volumes on each LSI SAS2 controller (or one mirrored volume and one Integrated Striping volume). Typically, one of these volumes is the boot volume. Boot support is available through the firmware of the LSI SAS2 controller that supports the standard Fusion-MPT interface. The runtime mirroring of the boot disk is transparent to the BIOS, the drivers, and the operating system.

Host-based status software monitors the state of the mirrored disks and reports any error conditions. Figure 4-1 shows an Integrated Mirroring volume in which the second disk is a mirrored copy of the data on the first (primary) disk.

Figure 4-1 Typical Integrated Mirroring Implementation

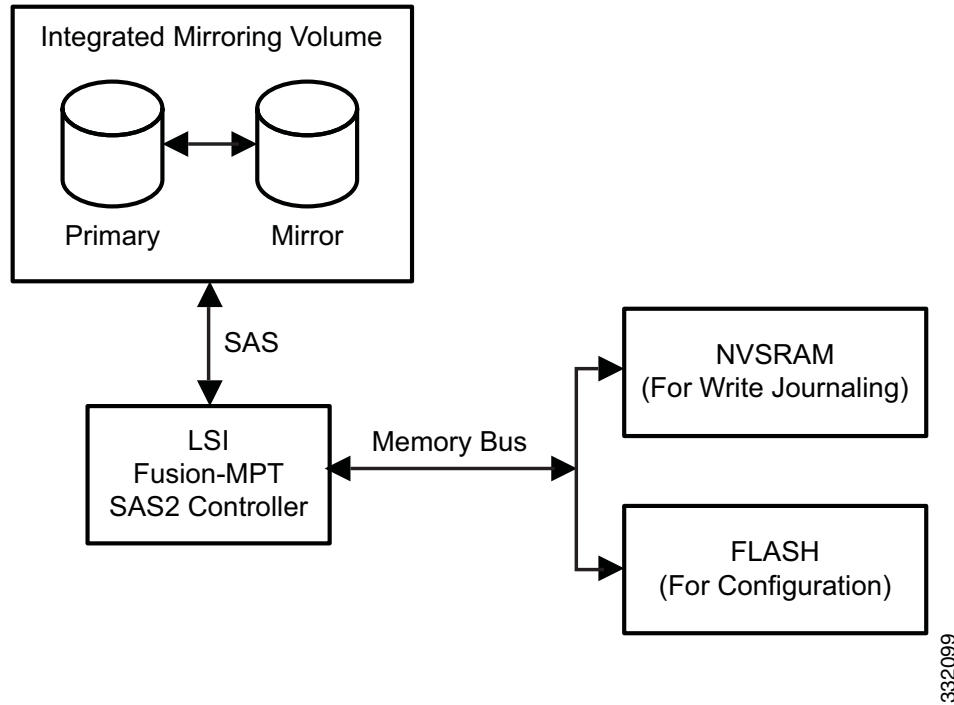
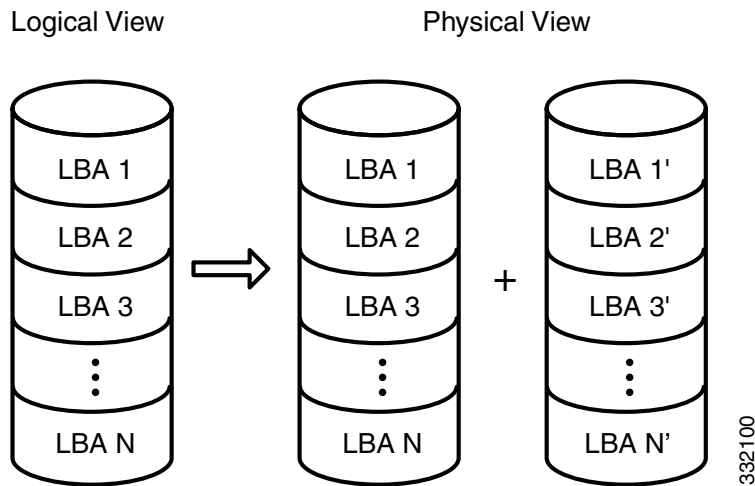

Figure 4-2 shows the logical view and physical view of an Integrated Mirroring volume. Each logical block address (LBA) is mirrored on the second disk.

Figure 4-2 Integrated Mirroring Volume



You can configure an Integrated Mirroring Enhanced volume with up to ten mirrored disks. Figure 4-3 shows the logical view and physical view of an Integrated Mirroring Enhanced volume with three mirrored disks. The firmware writes each mirrored stripe to a disk and mirrors it to an adjacent disk. RAID 1E is another term for this type of mirrored configuration.

Figure 4-3 Integrated Mirroring and Striping with Three Mirrored Disks

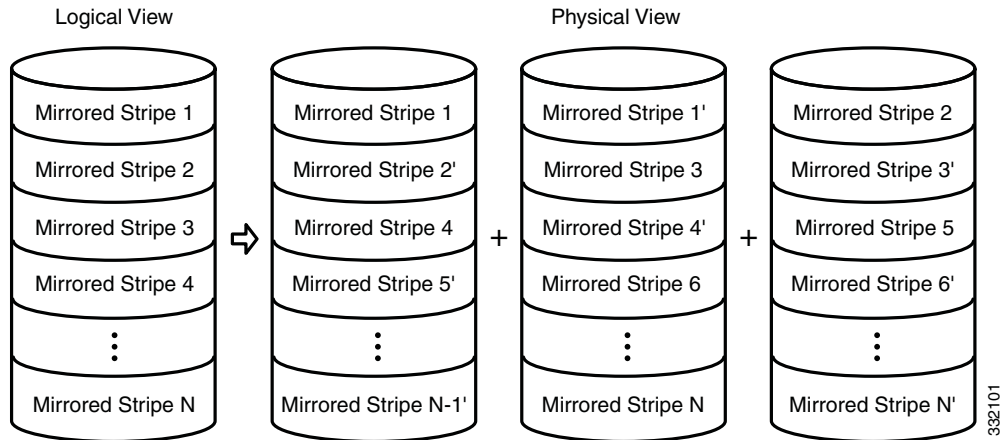

You can configure an Integrated Mirroring and Striping volume with an even number of disks, ranging from a minimum of four to a maximum of ten. Figure 4-4 shows the logical and physical views of an Integrated Mirroring and Striping volume with four mirrored disks. The firmware writes each mirrored stripe to a disk and mirrors it to an adjacent disk. RAID 10 is another term for this type of mirrored/striped configuration.

Figure 4-4 Integrated Mirroring and Striping with Four Mirrored Disks

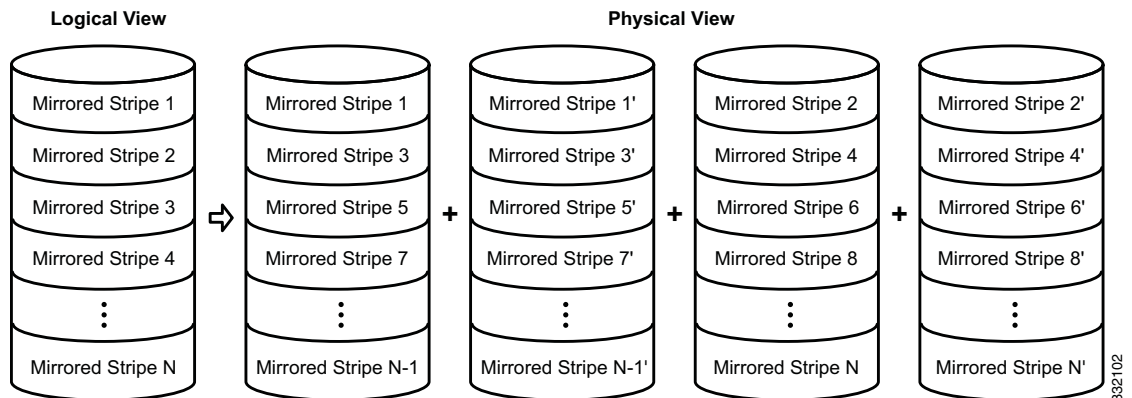

The LSI SAS2 BIOS Configuration Utility enables you to create mirrored volumes during initial setup and to reconfigure them in response to hardware failures or changes in the environment.



Caution

The LSI SAS2 BIOS Configuration Utility deletes all existing data from the disks drives when you choose to use the drives for a mirrored volume.

Mirrored Volume Features

This section lists the features of Integrated Mirroring, Integrated Mirroring and Striping, and Integrated Mirroring Enhanced volumes. You can configure one or two mirrored volumes on each LSI SAS2 controller.

- Resynchronization with Concurrent Host I/O Operation

The Integrated RAID firmware allows host I/O transactions to continue on a mirrored volume while it resynchronizes the volume in the background. The firmware automatically starts resynchronizing data after a disk failure activates a hot spare or after a disk in a mirrored volume has been hot swapped.

- Hot Swapping

The Integrated RAID firmware supports hot swapping, and it automatically resynchronizes the hot-swapped disk in the background without any host or user intervention. The firmware detects hot-swap removal and disk insertion.

Following a hot-swap event, the firmware verifies that the new physical disk has enough capacity for the mirrored volume. The firmware resynchronizes all replaced hot-swapped disks, even if the same disk is reinserted. In a mirrored volume with an even numbers of disks, the firmware marks the hot-swapped disk as a secondary disk and the other disk with data as the primary disk. The firmware resynchronizes all data from the primary disk onto the new secondary disk. In a mirrored volume with an odd number of disks, primary and secondary sets include three disks instead of two.

- Hot Spare Disk

You can configure two disks as global hot spare disks to protect data on the mirrored volumes configured on the SAS2 controller. If the Integrated RAID firmware fails one of the mirrored disks, it automatically replaces the failed disk with a hot spare disk and resynchronizes the mirrored data. The firmware automatically receives a notification when a hot spare replaces the failed disk, and it then designates that disk as the new hot spare.

- Online Capacity Expansion

The online capacity expansion (OCE) feature enables you to expand the capacity of an existing two-disk Integrated Mirroring (RAID 1) volume by replacing the original disk drives with higher-capacity drives that have the same protocol (SAS or SATA).



Note

The new drives must have at least 50 GB more capacity than the original drives of the volume.

After you replace the disk drives and run the OCE command, you must use a commercial tool that is specific to the operating system to move or increase the size of the partition on the volume.

- Media Verification

The Integrated RAID firmware supports a background *media verification* feature that runs at regular intervals when the mirrored volume is in the Optimal state. If the verification command fails for any reason, the firmware reads the other disk's data for this segment and writes it to the failing disk in an attempt to refresh the data. The firmware periodically writes the current media verification logical block address to nonvolatile memory so that the media verification can continue from where it stopped prior to a power cycle.

- Disk Write Caching

By default, the Integrated RAID firmware disables disk write caching for mirrored volumes to ensure that the write journal entry stored in the nonvolatile static RAM (NVSRAM) is always valid. If you enable disk write caching (not recommended), you might cause the disk write log to be invalid.

- NVSRAM Usage

The Integrated RAID firmware requires at least a 32-KB NVSRAM to perform write journaling for mirrored volumes on LSI SAS2 controllers. The NVSRAM also preserves configuration information across reboots. The firmware uses write journaling to verify that the disks in the mirrored volume are synchronized with each other.

- Background Initialization

Background initialization (BGI) is the process of copying data from primary to secondary disks in a mirrored volume. The Integrated RAID firmware starts BGI automatically as a background task when it creates a volume. The volume remains in the Optimal state while BGI is in progress.

- Consistency Check

A consistency check is a background process that reads data from primary and secondary disks in a mirrored volume and compares it to make sure that the data is identical on both disks. You can use the LSI SAS2 BIOS Configuration Utility to run a consistency check on a mirrored volume.

- Make Data Consistent Process

If enabled in the Integrated RAID firmware, the make data consistent (MDC) process starts automatically and runs in the background when you move a redundant volume from one SAS controller to another SAS controller. MDC compares the data on the primary and secondary disks. If it finds inconsistencies, it copies data from the primary disk to the secondary disk.

Mirroring and Mirroring Enhanced Features

Integrated Mirroring, Integrated Mirroring and Striping, and Integrated Mirroring Enhanced volumes support the following features:

- Configurations of one or two mirrored volumes on each LSI SAS2 controller. Each volume can consist of two mirrored disks for an Integrated Mirroring volume; three to ten mirrored disks for an Integrated Mirroring Enhanced volume; or four, six, eight, or ten mirrored disks for an Integrated Mirroring and Striping volume.
- Two optional global hot spare disks per LSI SAS2 controller to automatically replace failed disks in mirrored volumes.
- Ability of mirrored volumes to run in optimal mode or in degraded mode if one mirrored disk in an Integrated Mirroring volume fails or if one or more mirrored disks fail in an Integrated Mirroring and Striping volume or Integrated Mirroring Enhanced volume.
- Support for hot swapping.
- Support for online capacity expansion (OCE) for RAID1 volumes. OCE allows you to increase the size of a RAID1 volume by replacing the existing disk drives with higher-capacity disk drives. Data is protected during the expansion process, and the RAID1 volume remains online.
- Presentation of a single, virtual drive to the operating system for each mirrored volume.
- Support for both SAS and SATA disks, although you cannot combine the two types of disks in the same volume. However, an LSI SAS2 controller can support one volume with SATA disks and a second volume with SAS disks.
- Automatic background initialization after volume creation.

- Consistency checking.
- Fusion-MPT architecture.
- Menu-driven, BIOS-based configuration utility.
- Error notification, in which the drivers update an OS-specific event log.
- Support for SCSI Enclosure Services (SES) status LED.
- Write journaling, which allows automatic synchronization of potentially inconsistent data after unexpected power-down situations.
- Use of metadata to store volume configuration on disks in a mirrored volume.
- Automatic background resynchronization while host I/Os continue.
- Background media verification, which ensures that data on mirrored volumes is always accessible.

Integrated Striping

This section provides an overview of the LSI Integrated RAID features that support the creation of striped arrays.

The LSI Integrated RAID solution enables you to create Integrated Striping volumes for applications that require the faster performance and increased storage capacity of striping. The low-cost Integrated Striping feature has many of the advantages of a more expensive RAID striping solution. You can configure an Integrated Striping volume as the boot disk or as a data disk.

The Integrated Striping solution provides better performance and more capacity than individual disks, without burdening the host CPU. The firmware distributes host I/O transactions over multiple disks and presents the disks as a single, logical drive. Striping is transparent to the BIOS, the drivers, and the operating system.

You can use the LSI SAS2 BIOS CU to configure Integrated Striping volumes. These volumes can consist of two to ten disks.

On Integrated Striping volumes, the firmware writes data across multiple disks instead of onto one disk by partitioning the storage space of each disk into 64-KB stripes. The firmware interleaves the stripes round-robin so that the combined storage space consists alternately of stripes from each disk.

[Figure 4-5](#) shows an example of integrated striping: the firmware writes segment 1 to disk 1, segment 2 to disk 2, segment 3 to disk 3, and so on. When the firmware reaches the end of the disk list, it continues writing data at the next available segment of disk 1.

Figure 4-5 Integrated Striping Example

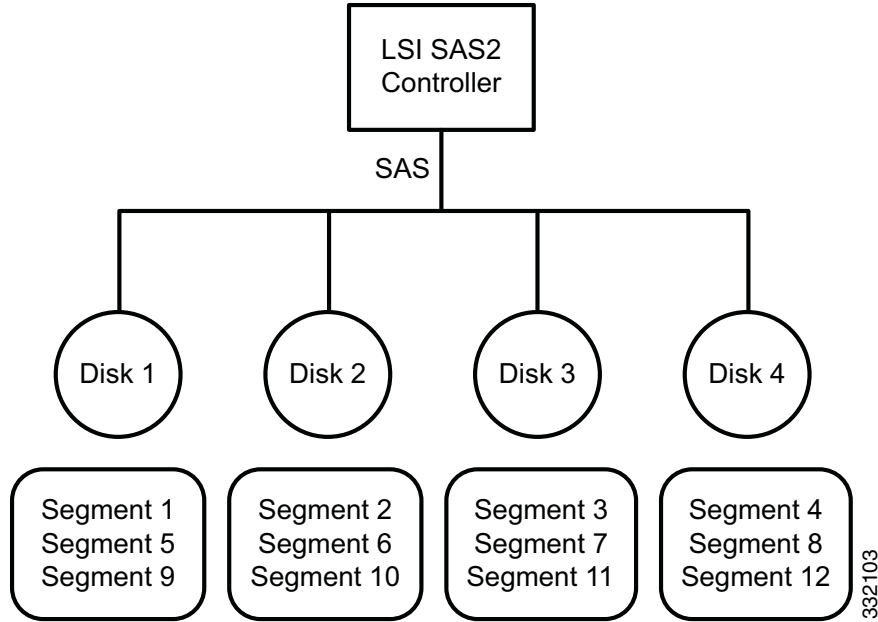
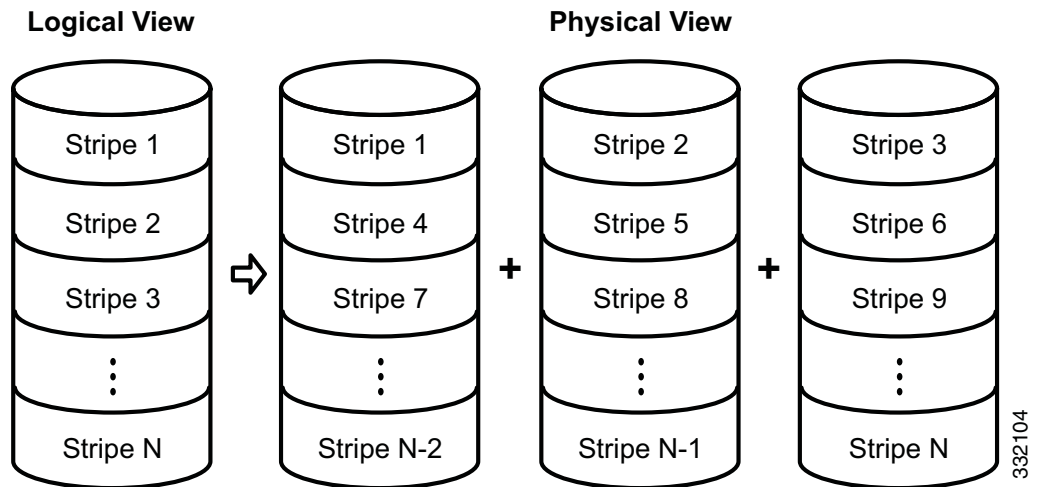

Figure 4-6 shows a logical view and a physical view of an Integrated Striping volume with three disks.

Figure 4-6 Integrated Striping—Logical and Physical Views



Speed is the primary advantage of the Integrated Striping solution because it transfers data to or from multiple disks simultaneously. However, there is no data redundancy. You should back up the data on other media to avoid losing unsaved data if one disk fails.

Integrated Striping Features

Integrated Striping supports the following features:

- Support for volumes with two to ten disks.
- Support for two Integrated Striping volumes with up to 14 drives total on a SAS2 controller.

- Support for combining one Integrated Striping volume and one Integrated Mirroring, Integrated Mirroring and Striping, or Integrated Mirroring Enhanced volume on a single controller.
- Support for both SAS and SATA drives, although you cannot combine the two types of drives in one volume.
- Fusion-MPT architecture.
- Easy-to-use SAS BIOS configuration utility.
- Error notification.
- Disk write caching, which is enabled by default on all Integrated Striping volumes.
- Use of metadata to store volume configurations on disks.
- OS-specific event log.
- Error display inside the Fusion-MPT BIOS.
- SCSI Enclosure Services (SES) status LED support for drives used in Integrated Striping volumes.

Creating Mirrored Volumes

The LSI SAS2 BIOS Configuration Utility is a menu-driven utility program that enables you to easily configure and manage Integrated RAID volumes. You can use the LSI SAS2 BIOS Configuration Utility to create one or two mirrored volumes on each LSI SAS2 controller, with up to two optional global hot spare disks. You must connect all disks in a mirrored volume to the same LSI SAS2 controller.

Although you can use different sized disks in mirrored volumes, the smallest disk in the volume determines the logical size of all disks in the volume. The volume does not use the excess space of the higher-capacity member disks. For example, if you create an Integrated Mirroring Enhanced volume with two 100-GB disks and two 120-GB disks, the volume uses only 100 GB on each of the 120-GB disks.

See [Mirrored Volumes, page 4-2](#), for more information about the features of Integrated Mirroring, Integrated Mirroring and Striping, and Integrated Mirroring Enhanced volumes.

Launching the LSI SAS2 BIOS Configuration Utility

The LSI SAS2 BIOS Configuration Utility is part of the Fusion-MPT BIOS.

Step 1 The BIOS loads during the startup sequence. After a message appears about the LSI Configuration Utility, press **Ctrl-C** to start the LSI SAS2 BIOS Configuration Utility.

- Next, the message changes to

```
Please wait, invoking SAS Configuration Utility...
```

- After a brief pause, the **Adapter List** window (main menu) of the LSI SAS2 BIOS Configuration Utility appears.

However, on some systems the following message appears:

```
LSI Corp Configuration Utility will load following initialization!
```

In this case, the LSI SAS2 BIOS Configuration Utility loads after the system completes its power-on self test (POST).

Once you launch the LSI SAS2 BIOS Configuration Utility, you can complete one of the following tasks:

- [Creating an Integrated Mirroring Volume, page 4-11](#)
- [Creating an Integrated Mirroring Enhanced or Integrated Mirroring and Striping Volume, page 4-13](#)
- [Creating Hot Spare Disks, page 4-15](#)
- [Deleting Hot Spare Disks, page 4-15](#)

Creating Mirrored Volumes

You can configure one or two Integrated Mirroring, Integrated Mirroring and Striping, and Integrated Mirroring Enhanced volumes on each LSI SAS2 controller. You can also configure one mirrored volume and one Integrated Striping volume on the same controller, which means that you can configure up to a maximum of 14 disk drives for the two volumes. This number includes one or two optional hot spare disks for the mirrored volume.

- All physical disks in a volume must be either SATA (with extended command set support) or SAS (with SMART support).



Note You cannot combine SAS and SATA disks in the same volume. However, you can create one volume with SAS disks and a second volume with SATA disks on the same controller.

- Disks must have 512-B blocks and must not have removable media.
- Integrated mirroring volumes must have two disks, Integrated Mirroring Enhanced volumes can have three to ten disks, and Integrated Mirroring and Striping volumes can have an even number of disks ranging from four to ten disks.



Note We strongly recommend that you create global hot spare disks for all mirrored volumes to increase the level of data protection. If a disk in a mirrored volume fails, the Integrated RAID firmware rebuilds it by using one of the global hot spares, and the data is safe. If you create two mirrored volumes on an LSI SAS2 controller, either of the two mirrored volumes can use the global hot spares if a disk fails.

Creating an Integrated Mirroring Volume

-
- Step 1** Start the SAS2 BIOS CU as shown in [Launching the LSI SAS2 BIOS Configuration Utility, page 4-10](#).
- Step 2** In the **Adapter List** window, use the arrow keys to choose an LSI SAS adapter and press **Enter**. The **Adapter Properties** window appears, as [Figure 4-7](#) shows.

Figure 4-7 Adapter Properties Window

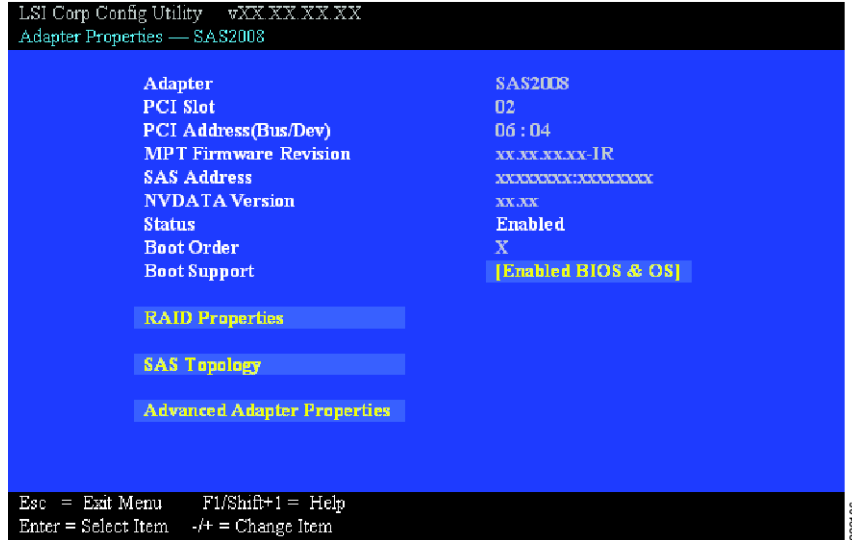

Step 3 Use the arrow keys to choose RAID Properties, and press **Enter**.

The **Create Array** window appears.

Step 4 Choose **Create RAID 1 Volume**.

The **Create New Array** window appears.

Step 5 Move the cursor to the **RAID Disk** column and choose a line that has a **No entry** in this column, indicating that the disk is not already part of the volume that you are creating. To add the disk to the new array, press **Spacebar** to change **No** to **Yes**.

This is the **Primary disk** in the array.



Caution

The SAS2 BIOS CU deletes all existing data from the disks drives when you choose them to use in a mirrored volume.

Step 6 To add the second disk to the array, move the cursor to another line and press **Spacebar**.

This is the **Secondary disk** in the array.

Step 7 To create the array, press **C**.

A menu window appears.

Step 8 From the menu options, choose **Save changes then exit this menu**.

A **processing** message appears briefly, and the SAS2 BIOS CU returns to the **Adapter Properties** window. Initialization of the new array continues in the background.



Note

To create a second Integrated Mirroring volume, repeat these instructions starting with [Step 3](#). To create an Integrated Mirroring Enhanced or Integrated Mirroring and Striping volume, follow the steps in [Creating an Integrated Mirroring Enhanced or Integrated Mirroring and Striping Volume](#), page 4-13.

**Note**

To create one or two global hot spares, follow the steps in [Managing Hot Spare Disks, page 4-15](#).

Creating an Integrated Mirroring Enhanced or Integrated Mirroring and Striping Volume

Integrated Mirroring Enhanced volumes can have from three to ten physical disks. Data is written to a disk and mirrored on an adjacent disk. Integrated Mirroring and Striping volumes can have a minimum of four and a maximum of ten physical disks, in even numbers. In an Integrated Mirroring Enhanced or Integrated Mirroring and Striping volume, the data is both mirrored and striped.

- Step 1** Start the SAS2 BIOS CU as shown in [Launching the LSI SAS2 BIOS Configuration Utility, page 4-10](#).
- Step 2** In the **Adapter List** window, use the arrow keys to choose an LSI SAS adapter and press **Enter**.
The **Adapter Properties** window appears, as [Figure 4-7](#) shows.
- Step 3** Use the arrow keys to choose **RAID Properties** and press **Enter**.
The **Create Array** window appears.
- Step 4** Choose **Create RAID 1E Volume**.
The **Create New Array** window appears.
- Step 5** Move the cursor to the **RAID Disk** column and choose a line that has a **No entry** in this column, indicating that the disk is not already part of the volume that you are creating. To add the disk to the new array, press **Spacebar** to change **No** to **Yes**.

**Caution**

The SAS2 BIOS CU deletes all existing data from the disk drives when you choose the drives to use for a mirrored volume.

- Step 6** Move the cursor to another line and press **Spacebar** to add another disk to the array:
- If you choose an odd number of disks, the SAS2 BIOS CU creates an Integrated Mirroring Enhanced array.
 - If you choose an even number of disks, it creates an Integrated Mirroring and Striping array. As you add disks, the Array Size field changes to reflect the size of the new array.
- Step 7** To create the array, press **C**.
A menu window appears.
- Step 8** From the menu options, choose **Save changes then exit this menu**.
A processing message appears briefly, and the SAS2 BIOS CU returns to the **Adapter Properties** window. Initialization of the new array continues in the background.

**Note**

To create a second Integrated Mirroring Enhanced or Integrated Mirroring and Striping volume, repeat the instructions above starting with [Step 3](#).

**Note**

To create one or two global hot spares, follow the steps in [Managing Hot Spare Disks, page 4-15](#).

Expanding an Integrated Mirroring Volume with OCE

You can use the online capacity expansion (OCE) feature to expand the capacity of a two-disk Integrated Mirroring (RAID1) volume by replacing the original disks with two higher-capacity disk drives while the volume remains online. This process maintains data integrity at all times, even if one of the disks fails during the replacement process. The new disks must have at least 50 GB more capacity than the disks they are replacing, and they must use the same protocol (SAS or SATA) as the disks they are replacing.

-
- Step 1** Physically replace one of the two volume disk drives with a drive that has at least 50 GB more capacity. If necessary, you can identify the disks in the volume by following the instructions in [Locating Disk Drives in a Volume, page 4-22](#).
- Step 2** Wait until synchronization completes on the new disk and the volume returns to the **Optimal state**, as indicated in the **Adapter Properties** window.
- Step 3** Physically replace the other volume disk drive with a drive that has at least 50 GB more capacity.
- Step 4** Wait until synchronization completes on the new disk and the volume returns to the **Optimal state**.
- Step 5** In the **Adapter List** window of the SAS2 BIOS CU, use the arrow keys to choose the **LSI SAS adapter** with the RAID 1 volume and press **Enter**.
The **Adapter Properties** window appears.
- Step 6** Use the arrow keys to choose **RAID Properties**, and press **Enter**.
The **Select New Array Type** window appears.
- Step 7** Choose **View Existing Array**.
The **View Array** window appears. If necessary, press **Alt-N** to switch to the RAID 1 volume with the new, higher-capacity disk drives.
- Step 8** Choose **Manage Array**.
The **Manage Array** window appears.
- Step 9** Choose **Online Capacity Expansion**.
A menu window appears with a warning message and with options to start the expansion process or quit.
- Step 10** To start the expansion, press **Y**.
When the expansion process completes, the **RAID Properties** window appears.
- Step 11** Run a commercial tool that is specific to the operating system to move or increase the size of the partition on the newly expanded RAID 1 volume.
-

Managing Hot Spare Disks

You can create one or two global hot spare disks to protect the data on mirrored volumes on an LSI SAS2 controller. You can also delete hot spare disks.

Creating Hot Spare Disks

-
- Step 1** Start the LSI SAS2 BIOS Configuration Utility as shown in [Launching the LSI SAS2 BIOS Configuration Utility, page 4-10](#).
 - Step 2** In the **Adapter List** window, use the arrow keys to choose an LSI SAS adapter and press **Enter**. The **Adapter Properties** window appears, as [Figure 4-7](#) shows.
 - Step 3** Use the arrow keys to choose **RAID Properties**, and press **Enter**. The **Select New Array Type** window appears.
 - Step 4** Choose **View Existing Array**. The **View Array** window appears. If necessary, press **Alt-N** to switch to another array on this adapter.
 - Step 5** Choose **Manage Array**. The **Manage Array** window appears.
 - Step 6** Choose **Manage Hot Spares**, which is the first option. The **Manage Hot Spares** window appears.
 - Step 7** Identify a disk that is not part of a RAID volume (that is, the value in the Drive Status column is not **RAID**) and that is not already identified as a hot spare disk.
A global hot spare disk must have 512-byte blocks and nonremovable media. The disk type must be either SATA with extended command set support or SAS with SMART support.
 - Step 8** Choose the **Hot Spr** (Hot Spare) field for this disk and press **Spacebar**. The **Hot Spare** status changes to **Yes**.
 - Step 9** (Optional) Repeat [Step 8](#) to choose a second global hot spare disk.
 - Step 10** To create the hot spare disk, press **C**.
A menu window appears. An error message appears if the chosen disk is not at least as large as the smallest disk used in the existing volume. An error message also appears if you try to add a SATA disk as a hot spare for volumes that use SAS disks, or if you try to add a SAS disk as a hot spare for volumes that use SATA disks.
 - Step 11** Choose **Save changes then exit this menu** to create the hot spare disk. The **SAS2 BIOS CU** pauses while it configures the global hot spares.
-

Deleting Hot Spare Disks

-
- Step 1** Access the **Manage Hot Spares** window by following [Step 1](#) through [Step 6](#) of [Expanding an Integrated Mirroring Volume with OCE, page 4-14](#).
 - Step 2** Choose a hot spare disk for deletion, and press **C**.
 - Step 3** Choose **Save changes then exit this menu** to commit the changes.

The SAS2 BIOS CU pauses while it removes the global hot spare.

Other Configuration Tasks

This section describes how to perform other configuration and maintenance tasks for mirrored volumes.

Viewing Volume Properties

-
- Step 1** In the SAS2 BIOS CU, choose an **LSI SAS2 adapter** from the **Adapter List**.
The **Adapter Properties** window appears.
- Step 2** Choose **RAID Properties**.
The **Select New Array Type** window appears.
- Step 3** Choose **View Existing Array**.
The **View Array** window appears, showing information about the array and each disk in it. The window includes global hot spare information, if any exists.
-  **Note** If you create one volume using SAS disks, another volume using SATA disks, and one or two global hot spare disks, the hot spare disks only appear when you view the mirrored volume that uses the same type of disks as the hot spare disks.
-
- Step 4** If the currently displayed array is not the one you want, press **Alt-N** to view another array in the adapter.
-

Running a Consistency Check

Use the **Consistency Check** command to verify that the data is synchronized in the mirrored disks in the volume.

- Step 1** In the **Adapter List** window, use the arrow keys to choose an **LSI SAS adapter**.
The **Adapter Properties** window appears.
- Step 2** Use the arrow keys to choose **RAID Properties**, and press **Enter**.
The **Select New Array Type** window appears.
- Step 3** Choose **View Existing Array**.
The **View Array** window appears. If necessary, press **Alt-N** to switch to another array on this adapter.
- Step 4** Choose **Manage Array**.
The **Manage Array** window appears.
- Step 5** Choose **Consistency Check** in the **Manage Array** window.
A menu window appears.
- Step 6** Press **Y** to start the consistency check.

The consistency check runs a read-read-compare algorithm in the background. If it encounters any data mismatches, it stores the information in a bad block table.

Activating an Array

A volume (array) can become inactive if, for example, you remove it from one controller or computer and install it on a different one. The Activate Array option allows you to reactivate an inactive volume. This option is available only when the chosen volume is currently inactive.

- Step 1** In the **Adapter List** window, use the arrow keys to choose an **LSI SAS adapter** and press **Enter**.
The **Adapter Properties** window appears.
 - Step 2** Choose **RAID Properties**, and press **Enter**.
The **Select New Array Type** window appears.
 - Step 3** Choose **View Existing Array**.
The **View Array** window appears. If necessary, press **Alt + N** to switch to another array on this adapter.
 - Step 4** Choose **Manage Array**.
The **Manage Array** window appears.
 - Step 5** Choose **Activate Array** in the **Manage Array** window.
A menu window appears.
 - Step 6** Press **Y** to activate the array.
The array becomes active after a pause.
-

Deleting an Array



Caution

Before you delete an array, be sure to back up all data on the array that you want to keep.

- Step 1** In the **Adapter List** window, use the arrow keys to choose an **LSI SAS adapter**.
The **Adapter Properties** window appears.
- Step 2** Use the arrow keys to choose **RAID Properties**, and press **Enter**.
The **Select New Array Type** window appears.
- Step 3** Choose **View Existing Array**.
The **View Array** window appears. If necessary, press **Alt + N** to switch to another array on this adapter.
- Step 4** Choose **Manage Array**.
The **Manage Array** window appears.
- Step 5** Choose **Delete Array**.
A menu window appears.
- Step 6** Press **Y** to delete the array, or press **N** to cancel the deletion process.

After a pause, the utility deletes the array. If there is another remaining array and one or two hot spare disks, the BIOS checks the hot spare disks to determine if they are compatible with the remaining volume. If they are not compatible (too small or wrong disk type), the BIOS deletes them also.

Locating Disk Drives in a Volume

You can use the SAS2 BIOS CU to locate and identify a specific physical disk drive in a disk enclosure by flashing the drive's LED. You can also flash the LEDs of all the disk drives in a RAID volume, if they are in a disk enclosure.

When you add a disk drive to a new mirrored volume, the LED on the disk drive starts flashing. The LED stops flashing when you finish creating the volume.

-
- Step 1** Choose the desired **SAS2 controller** in the **Adapter List** window and press **Enter**.
The **Adapter Properties** window appears.
- Step 2** Highlight **SAS Topology** and press **Enter**.
The **SAS Topology** window appears.
- Step 3** Choose the disk in the **Device Identifier** column and press **Enter**.
The LED on the disk flashes until you press a key to stop it.
- Step 4** Choose the volume in the left column of the **SAS Topology** window and press **Enter** to identify all the disk drives in a volume.
The LEDs flash on all disk drives in the volume until you press a key to stop them.



Note

The LEDs on the disk drives flash as previously described if the firmware configuration is correct and the drives are in a disk enclosure.

Choosing a Boot Disk

You can choose a boot disk in the SAS Topology window. The next time you boot the computer, the firmware moves this disk to scan ID 0, making it the new boot disk, which makes it easier to set BIOS boot device options and to keep the boot device constant during device additions and removals. You can also choose an alternative boot device. If the BIOS cannot find the preferred boot device when it loads, it attempts to boot from the alternate device.

-
- Step 1** In the **SAS2 BIOS CU**, choose an adapter from the **Adapter List**.
- Step 2** Choose the **SAS Topology** option. If a device is currently designated as the boot device, the **Device Info** column in the **SAS Topology** window lists the word *Boot*, as shown in [Figure 4-8](#).

Figure 4-8 Boot Device on the SAS Topology Window

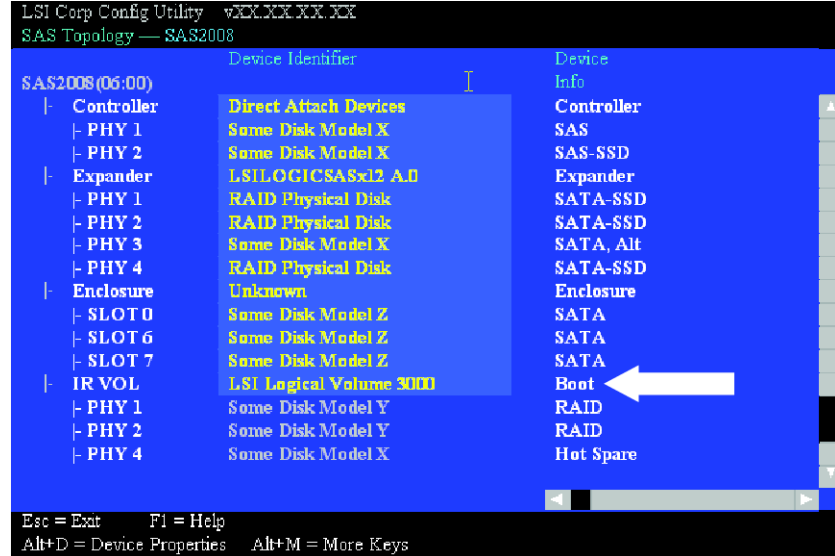

If a device is currently designated as the alternate boot device, the **Device Info** column shows the word **Alt**.

- Step 3** Move the cursor to the disk and press **Alt-B** to choose the preferred boot disk.
- Step 4** Move the cursor to the current boot disk and press **Alt-B** to remove the boot designator.
- This controller no longer has a disk designated as boot.
- Step 5** Move the cursor to the new boot disk and press **Alt-B** to change the boot disk.
- The **Boot** designator moves to this disk.
- Step 6** Move the cursor to the disk and press **Alt-A** to choose an alternate boot disk.



Note Follow [Step 4](#) and [Step 5](#) to change the alternate boot device from one disk to another, but use **Alt-A** instead of **Alt-B**.

Creating Integrated Striping Volumes

This section describes how to create Integrated Striping volumes using the LSI SAS2 BIOS Configuration Utility (SAS2 BIOS CU).

The LSI SAS2 BIOS CU is a menu-driven utility program that enables you to easily configure and manage Integrated RAID volumes. You can use the SAS2 BIOS CU to create one or two Integrated Striping volumes on each LSI SAS2 controller. Each volume can have from two to ten drives. All disks in an Integrated Striping volume must be connected to the same LSI SAS2 controller.

Although you can use disks of different sizes in Integrated Striping volumes, the smallest disk in the volume determines the logical size of all disks in the volume. The firmware does not use the excess space of the higher-capacity member disk. For example, if you create an Integrated Striping volume with two 100-GB disks and two 120-GB disks, the firmware uses only 100 GB on each of the 120-MB disks for the volume. The supported stripe size is 64 KB.

See [Integrated Striping, page 4-8](#) for more information about Integrated Striping volumes.

You can configure one or two Integrated RAID volumes on each LSI SAS2 controller. For a two-volume configuration, you can have two Integrated Striping (RAID 0) volumes, two mirrored volumes, or one volume of each type. The two volumes can have a maximum of 14 disk drives, which includes one or two hot spare disks for mirrored volumes.

The following guidelines apply when creating an Integrated Striping volume:

- All physical disks in an Integrated Striping volume must be either SATA (with extended command set support) or SAS (with SMART support). You cannot combine SAS and SATA disks in the same volume. However, you can create one volume with SAS disks and a second volume with SATA disks on the same controller.
- Disks must have 512-B blocks and must not have removable media.
- Integrated Striping volumes must have at least two disks and no more than ten disks. Integrated Striping volumes do not support hot spare disks.

-
- Step 1** In the **Adapter List** window, choose an **LSI SAS** adapter and press **Enter**.
The **Adapter Properties** window appears as seen in [Figure 4-7](#).
- Step 2** Choose **RAID Properties** and press **Enter**.
The **Create Array** window appears.
- Step 3** Choose **Create RAID 0 Volume**.
The **Create New Array** window appears.
- Step 4** Move the cursor to the RAID Disk column and choose a line that has a **No entry** in this column, which indicates that the disk is not already part of the volume you are creating.
To add the disk to the new array, press **Spacebar** to change the **No** to **Yes**.
- Step 5** Move the cursor to another line and press **Spacebar** to add another disk to the array.
- Step 6** Continue adding disks in this way until you have added the desired number of disks.
- Step 7** Press **C** to create the array.
A menu appears.
- Step 8** From the menu options, choose **Save changes then exit this menu**.
A processing message appears briefly, and the **SAS2 BIOS CU** returns to the **Adapter Properties** window. Initialization of the new array continues in the background.



Note

Repeat the previous instructions to create a second Integrated Striping volume, if desired, and if enough additional disks are available.

Other Configuration Tasks

This section describes how to perform other configuration and maintenance tasks for Integrated Striping volumes.

Viewing Volume Properties

-
- Step 1** In the **SAS2 BIOS CU**, choose an **LSI SAS2** adapter from the **Adapter List**.
The **Adapter Properties** window appears.
- Step 2** Choose **RAID Properties**.
The **Select New Array Type** window appears.
- Step 3** Choose **View Existing Array**.
The **View Array** window appears, showing information about the array and each disk in it.
- Step 4** If the currently displayed array is not the one you want, press **Alt-N** to view another array on the adapter.
-

Activating an Array

A volume (array) can become inactive if, for example, you remove it from one controller or computer and install it on a different one. The Activate Array option allows you to reactivate an inactive volume. This option is available only when the chosen volume is currently inactive.

-
- Step 1** In the **Adapter List** window, use the arrow keys to choose an **LSI SAS** adapter and press **Enter**.
The **Adapter Properties** window appears.
- Step 2** Choose **RAID Properties**, and press **Enter**.
The **Select New Array Type** window appears.
- Step 3** Choose **View Existing Array**.
The **View Array** window appears. If necessary, press **Alt-N** to switch to another array on this adapter.
- Step 4** Choose **Manage Array**.
The **Manage Array** window appears.
- Step 5** Choose **Activate Array** in the **Manage Array** window.
A menu window appears.
- Step 6** Press **Y** to activate the array.
The array becomes active after a pause.
-

Deleting an Array

**Caution**

Before you delete an array, be sure to back up the data.

-
- Step 1** In the **Adapter List** window, use the arrow keys to choose an **LSI SAS** adapter.
The **Adapter Properties** window appears.
Use the arrow keys to choose RAID Properties, and press **Enter**.
The **Select New Array Type** window appears.
- Step 2** Choose **View Existing Array**.
The **View Array** window appears. If necessary, press **Alt-N** to switch to another array on this adapter.
- Step 3** Choose **Manage Array**.
The **Manage Array** window appears.
- Step 4** Choose **Delete Array**.
A menu window appears.
- Step 5** Press **Y** to delete the array, or press **N** to cancel the deletion process.
After a pause, the utility deletes the array.
-

Locating Disk Drives in a Volume

You can use the LSI SAS2 BIOS Configuration Utility to locate and identify a specific physical disk drive in a disk enclosure by flashing the drive's LED. You can also flash the LEDs of all the disk drives in a RAID volume, if they are in a disk enclosure.

When you add a disk drive to a new mirrored volume, the LED on the disk drive starts flashing. The LED stops flashing when you finish creating the volume.

-
- Step 1** Choose the desired **SAS2 controller** in the **Adapter List** window and press **Enter**.
The **Adapter Properties** window appears.
- Step 2** Highlight **SAS Topology** and press **Enter**.
The **SAS Topology window** appears.
- Step 3** Choose the disk in the **Device Identifier** column and press **Enter**.
The LED on the disk flashes until you press a key to stop it.
- Step 4** Choose the volume in the left column of the **SAS Topology** window and press **Enter** to identify all the disk drives in a volume,
The LEDs flash on all disk drives in the volume until you press a key to stop them.



Note

The LEDs on the disk drives flash, as previously described, if the firmware configuration is correct and the drives are in a disk enclosure.

Choosing a Boot Disk

You can choose a boot disk in the SAS Topology window. The next time you boot the computer, the firmware moves this disk to scan ID 0, making it the new boot disk, which makes it easier to set BIOS boot device options and to keep the boot device constant during device additions and removals. You can also choose an alternative boot device. If the BIOS cannot find the preferred boot device when it loads, it attempts to boot from the alternate device.

-
- Step 1** In the **LSI SAS2 BIOS Configuration Utility**, choose an adapter from the **Adapter List**.
- Step 2** Choose the **SAS Topology** option. If a device is currently designated as the boot device, the **Device Info** column in the **SAS Topology** window lists the word **Boot** (see [Figure 4-8 on page 4-19](#)).
- If a device is currently designated as the alternate boot device, the **Device Info** column shows the word **Alt**.
- Step 3** Move the cursor to the disk and press **Alt-B** to choose the preferred boot disk.
- Step 4** Move the cursor to the current boot disk and press **Alt-B** to remove the boot designator.
- This controller no longer has a disk designated as boot.
- Step 5** Move the cursor to the new boot disk and press **Alt-B** to change the boot disk.
- The Boot designator moves to this disk.
- Step 6** Move the cursor to the disk and press **Alt-A** to choose an alternate boot disk.
- To change the alternate boot device from one disk to another, follow [Step 4](#) and [Step 5](#) in this procedure, but use **Alt-A** instead of **Alt-B**.
-

Determining Which Controller is in Your Server

Supported RAID controllers for all models are listed in [RAID Controllers in UCS Servers, page 3-10](#).

If you do not have a record of which device is used in the server, you can read the on-screen messages that are displayed during system bootup. These messages display information about the devices that are installed in your server.

- Information about the models of card installed are displayed as part of the verbose boot. You are also prompted to press **Ctrl-H** to launch configuration utilities for those cards. For servers running CIMC firmware earlier than release 1.2(1), see also [Disabling Quiet Boot for CIMC Firmware Earlier than Release 1.2\(1\), page 4-24](#).
- If a mezzanine-style card is enabled, you are prompted to press **Ctrl-C** to launch the configuration for these cards.
- If no models of card are displayed but there is a RAID configuration, your server is using the onboard ICH10R controller. You are also prompted to press **Ctrl-M** to launch the configuration utilities for this controller.

Figure 4-9 ICH10R Launch Window

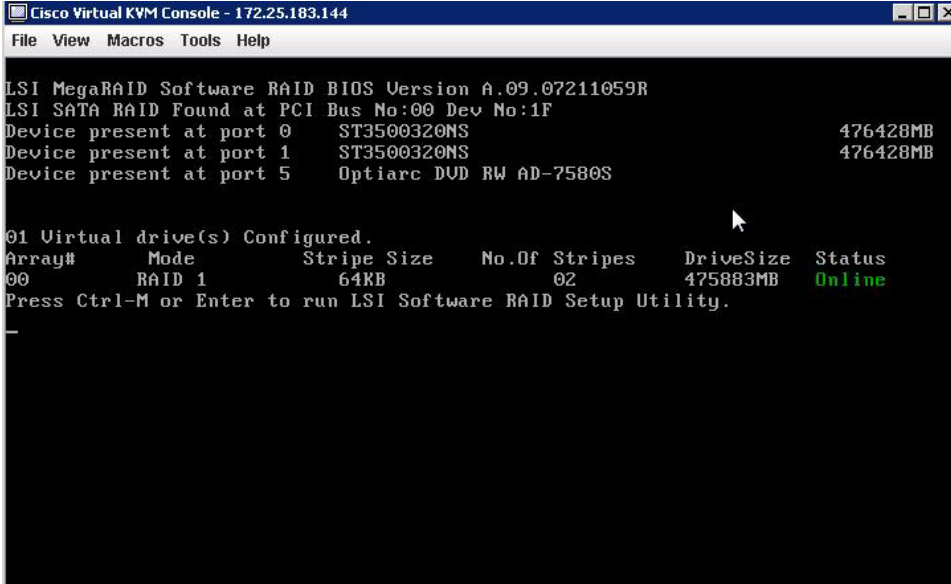

```

Cisco Virtual KVM Console - 172.25.183.144
File View Macros Tools Help

LSI MegaRAID Software RAID BIOS Version A.09.07211059R
LSI SATA RAID Found at PCI Bus No:00 Dev No:1F
Device present at port 0      ST3500320NS      476428MB
Device present at port 1      ST3500320NS      476428MB
Device present at port 5      Optiarc DVD RW AD-7580S

01 Virtual drive(s) Configured.
Array#   Mode      Stripe Size   No.Of Stripes   DriveSize   Status
00       RAID 1      64KB         02              475883MB   Online
Press Ctrl-M or Enter to run LSI Software RAID Setup Utility.

```

Disabling Quiet Boot for CIMC Firmware Earlier than Release 1.2(1)

For CIMC firmware and BIOS release 1.2(1) and later releases, Quiet Boot has been removed and is not required. If you are running CIMC firmware and BIOS earlier than release 1.2(1), you can use the following procedure to disable Quiet Boot.

-
- Step 1** Boot the server and watch for the F2 prompt during bootup.
 - Step 2** Press **F2** when prompted to enter the BIOS Setup utility.
 - Step 3** On the Main page of the BIOS Setup utility, set Quiet Boot to **Disabled**, which allows non-default messages, prompts, and POST messages to display during bootup instead of the Cisco logo window.
 - Step 4** Press **F10** to save your changes and exit the utility.
-

Launching Option ROM-Based Controller Utilities

To alter the RAID configurations on your hard drives, you can use your host-based utilities that you install on top of your host OS, or you can use the LSI option ROM-based utilities that are installed on the server.

When you boot the server and you have quiet boot disabled (see [Disabling Quiet Boot for CIMC Firmware Earlier than Release 1.2\(1\)](#), page 4-24), information about your controller is displayed with the prompts for the key combination to launch the option ROM-based utilities for your controller.

Watch for the prompt for your controller during verbose boot:

- The prompt for LSI controller card utility is **Ctrl-H**.
- The prompt for the mezzanine-style controller cards is **Ctrl-C**.
- The prompt for the onboard Intel ICH10R controller utility is **Ctrl-M**.

**Note**

Cisco has also developed the Cisco Server Configuration Utility for C-Series servers, which can assist you in setting up some RAID configurations for your drives. This utility is shipped with new servers on CD. You can also download the ISO from Cisco.com. See the user documentation for this utility at the following URL:

http://www.cisco.com/en/US/docs/unified_computing/ucs/sw/ucsscu/user/guide/20/SCUUG20.html

Restoring RAID Configuration After Replacing a RAID Controller

When you replace a RAID controller, the RAID configuration that is stored in the controller is lost. Use the following procedure to restore your RAID configuration to your new RAID controller.

-
- Step 1** Replace your RAID controller.
- Step 2** If this was a full chassis swap, replace all drives into the drive bays, in the same order that they were installed in the old chassis.
- Step 3** If Quiet Boot is enabled, disable it in the system BIOS. See [Disabling Quiet Boot for CIMC Firmware Earlier than Release 1.2\(1\), page 4-24](#).
- Step 4** Reboot the server and watch for the prompt to press F.
- Step 5** Press **F** when you see the following on-screen prompt:
- ```
Foreign configuration(s) found on adapter.
Press any key to continue or 'C' load the configuration utility,
or 'F' to import foreign configuration(s) and continue.
```
- Step 6** Press any key (other than C) to continue when you see the following message:
- ```
All of the disks from your previous configuration are gone. If this is  
an unexpected message, then please power of your system and check your cables  
to ensure all disks are present.  
Press any key to continue, or 'C' to load the configuration utility.
```
- Step 7** Watch the subsequent windows for confirmation that your RAID configuration was imported correctly.
- If you see the following message, your configuration was successfully imported. The LSI virtual drive is also listed among the storage devices.

```
N Virtual Drive(s) found on host adapter.
```
 - If you see the following message, your configuration was not imported which can happen if you do not press F quickly enough when prompted. In this case, reboot the server and try the import operation again when you are prompted to press F.

```
0 Virtual Drive(s) found on host adapter.
```
-



CHAPTER 5

LSI MegaRAID SAS Controller Tasks

This chapter describes the LSI WebBIOS Configuration Utility (CU), which operates independently of the operating system and enables you to create and manage RAID configurations on LSI MegaRAID SAS controllers.

If your server has an integrated RAID SAS controller, see [Chapter 4, “Configuring the LSI SAS2 Integrated RAID Controller.”](#)

This chapter contains the following sections:

- [LSI MegaRAID Controller Management Utilities, page 5-1](#)
- [LSI WebBIOS CU, page 5-2](#)
- [Managing RAID, page 5-16](#)
- [Determining Which Controller is in Your Server, page 5-21](#)

LSI MegaRAID Controller Management Utilities

LSI offers these three main MegaRAID controller management utilities:

- LSI WebBIOS Configuration Utility
- MegaRAID Command Tool
- MegaRAID Storage Manager Software

The LSI utilities have help documentation for more information about using the utilities.

For basic information on RAID and how to use the LSI utilities, see the following documentation:

- [LSI MegaRAID SAS Software User Guide \(for LSI MegaRAID\).](#)

LSI WebBIOS Configuration Utility

The LSI WebBIOS Configuration Utility (CU) operates independently of the operating system and enables you to create and manage RAID configurations on LSI MegaRAID SAS controllers.

MegaRAID Command Tool

The LSI MegaRAID Command Tool (CT) is a command-line interface (CLI) utility that enables you to configure, monitor, and maintain LSI MegaRAID SAS controllers and the devices connected to them.

MegaRAID Storage Manager

The LSI MegaRAID Storage Manager (MSM) is a software application with a graphical user interface that enables you to configure, monitor, and maintain storage configurations on LSI MegaRAID SAS controllers.

LSI WebBIOS CU

The LSI WebBIOS CU, unlike the LSI MegaRAID Storage Manager software, resides in the SAS controller BIOS and operates independently of the operating system.

You can use the WebBIOS CU to do the following tasks:

- Create drive groups and virtual drives for storage configurations.
- Display controller, virtual drive, physical drive, and battery backup unit (BBU) properties, and change parameters.
- Delete virtual drives.
- Migrate a storage configuration to a different RAID level.
- Detect configuration mismatches.
- Import a foreign configuration.
- Scan devices connected to the controller.
- Initialize virtual drives.

The WebBIOS CU provides a configuration wizard to guide you through the configuration of virtual drives and drive groups.

Starting the WebBIOS CU

Step 1 When the host computer is booting, the following text appears:

```
Copyright© LSI Corporation  
Press <Ctrl><H> for WebBIOS  
Press Ctrl+H.
```

The **Controller Selection** window appears.

Step 2 If the system has multiple SAS controllers, choose a controller.

Step 3 Click **Start** to continue.

The main **WebBIOS CU** window appears. See [Figure 5-1](#).

WebBIOS CU Main Menu Window Options

Figure 5-1 shows the window that appears when you start the WebBIOS CU and choose a controller.

Figure 5-1 Main WebBIOS CU Window

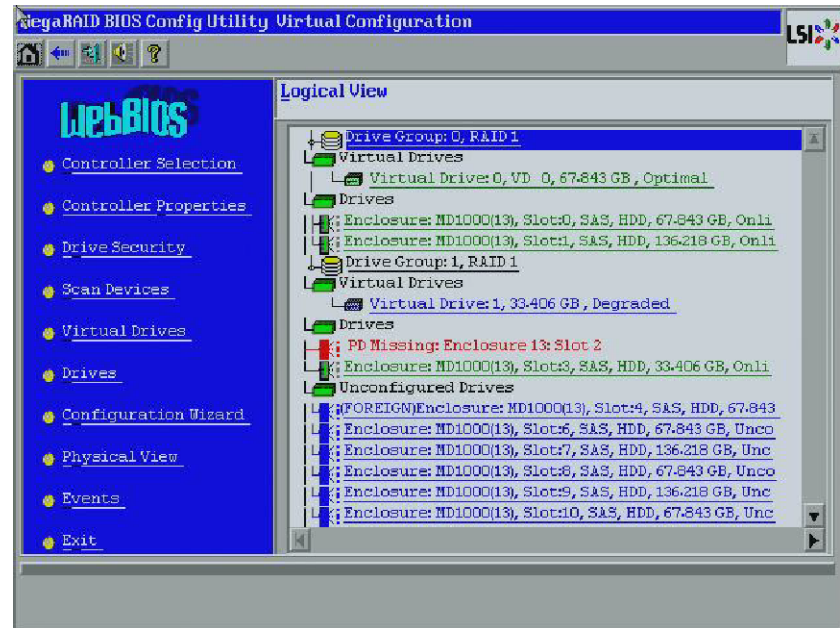

Listed in the right pane are the following:

- Virtual drives configured on the controller
- Drives that are connected to the controller
- Drives that are foreign or missing



Note

In the list of virtual drives, the drive nodes are sorted based on the order in which you added the drives to the drive group, rather than the physical slot order that displays in the physical trees.



Note

The minimum screen resolution for WebBIOS is 640x480.

Click **Physical View** or **Logical View** in the left pane to toggle between the physical view and logical view of the storage devices connected to the controller. When Physical View appears in the right pane, it shows the drive groups that are configured on this controller.

For drives in an enclosure, the window shows the following drive information:

- Enclosure
- Slot
- Interface type (such as SAS or SATA)
- Drive type (HDD or SSD)
- Drive size

- Drive status (such as Online or Unconfigured Good)

Toolbar

The toolbar at the top of the WebBIOS CU contains the following tools, from left to right (see [Figure 3-1](#)):

- Main window—Click to return to the main window from any other WebBIOS CU window.
- Previous—Click to return to the previous window that you were viewing.
- Exit—Click to exit the WebBIOS CU program.
- Turn off alarm—Click to turn off the sound from the onboard controller alarm.
- About—Click to display information about the WebBIOS CU version, browser version, and HTML interface engine.

Menu Options

These options are located in the left pane of the main WebBIOS CU window (the hotkey shortcut for each option is shown in parentheses next to the option name):

- Controller Selection (Alt-c)—Views the Controller Selection window, where you can choose a different SAS controller. You can then view information about the controller and the devices connected to it, or create a new configuration on the controller.
- Controller Properties (Alt-p)—Views the properties of the currently chosen SAS controller. For more information, see [Table 5-1](#).
- Scan Devices (Alt-s)—Allows the WebBIOS CU to rescan the physical and virtual drives for any changes in the drive status or the physical configuration. The WebBIOS CU displays the results of the scan in the physical and virtual drive descriptions.
- Virtual Drives (Alt-v)—Views the Virtual Drives window, where you can change and view virtual drive properties, delete virtual drives, initialize drives, and perform other tasks. For more information, see [Viewing Virtual Drive Properties, Policies, and Operations, page 5-13](#).
- Drives (Alt-d)—Views the Drives window, where you can view drive properties, create hot spares, and perform other tasks. For more information, see [Viewing Physical Drive Properties and Operations, page 5-14](#).
- Configuration Wizard (Alt-o)—Starts the Configuration Wizard and creates a new storage configuration, clear a configuration, or add a configuration. For more information, see [Configuring RAID Drive Groups and Virtual Drives, page 5-5](#).
- Logical View (Alt-l)—Toggles between the Physical View window and the Logical View window.
- Physical View (Alt-h)—Toggles between the Physical View window and the Logical View window.
- Events (Alt-e)—Views system events in the Event Information window. For more information, see [Managing RAID, page 5-16](#).
- Exit (Alt+x)—Exits the WebBIOS CU and continue with system boot.

Configuring RAID Drive Groups and Virtual Drives

This section describes how to use the WebBIOS CU Configuration Wizard to configure RAID drive groups and virtual drives to create storage configurations.

Choosing the Configuration with the Configuration Wizard

Step 1 Click **Configuration Wizard** in the left pane of the WebBIOS main window.

The first **Configuration Wizard** window opens.

Step 2 Choose a configuration type:



Caution

If you choose **Clear Configuration** or **New Configuration**, all existing data in the configuration is deleted. Back up data that you want to keep before you choose a configuration type.

- **Clear Configuration**—Clears the existing configuration.
- **New Configuration**—Clears the existing configuration and allows you to create a new configuration.
- **Add Configuration**—Retains the existing storage configuration and adds new drives to it (this option does not cause any data loss).

Step 3 Click **Next**.

The **WebBIOS Configuration Method** window opens.

Step 4 Choose a configuration method:

- **Manual Configuration**—Allows you to control all attributes of the new storage configuration as you create drive groups and virtual drives, and set their parameters.
- **Automatic Configuration**—Automatically creates an optimal RAID configuration.

If you choose Automatic Configuration, you can choose whether to create a redundant RAID drive group or a nonredundant RAID 0 drive group. Choose one of the following from the **Redundancy** drop-down list:

Redundancy when possible

No redundancy

Step 5 Click **Next** to continue.

- For Automatic Configuration, continue with [Using Automatic Configuration, page 5-5](#).
 - For Manual Configuration, continue with [Using Manual Configuration, page 5-6](#).
-

Using Automatic Configuration

Step 1 When WebBIOS displays the proposed new configuration, review the information in the window, and click **Accept** or click **Back** to change the configuration.

One of the following configuration appears:

- **RAID 0**—If you choose **Automatic Configuration** and **No Redundancy**, WebBIOS creates a RAID 0 configuration.
- **RAID 1**—If you choose **Automatic Configuration** and **Redundancy when possible**, and only two drives are available, WebBIOS creates a RAID 1 configuration.
- **RAID 5**—If you choose **Automatic Configuration** and **Redundancy when possible**, and three or more drives are available, WebBIOS creates a RAID 5 configuration.
- **RAID 6**—If you choose **Automatic Configuration** and **Redundancy when possible**, and the RAID 6 option is enabled, and three or more drives are available, WebBIOS creates a RAID 6 configuration.

Step 2 When you are prompted to save the configuration, click **Yes**.

Step 3 When you are prompted to initialize the new virtual drives, click **Yes**.

WebBIOS CU begins a background initialization of the virtual drives.

New RAID 5 virtual drives and new RAID 6 virtual drives require a minimum number of drives for a background initialization to start. If there are fewer drives, the background initialization does not start. The following number of drives is required:

- New RAID 5 virtual drives must have at least five drives for a background initialization to start.
- New RAID 6 virtual drives must have at least seven drives for a background initialization to start.

Using Manual Configuration

This section contains the procedures for creating RAID drive groups for RAID levels 0, 1, 5, 6, 00, 10, 50, and 60.

Using Manual Configuration (RAID 0, 1, 5, 6)

For more information about RAID levels, see [RAID Levels, page 1-7](#).



Note

RAID level 0 is not fault tolerant. If a drive in a RAID 0 drive group fails, the whole virtual drive (all drives associated with the virtual drive) fails.

Step 1 Choose **Manual Configuration** and click **Next**.

The **Drive Group Definition** window appears. Use this window to choose drives to create drive groups.

Step 2 Press and hold **Ctrl** while choosing two or more ready drives in the **Drives** pane.

Choose all of the drives for the drive group.

Step 3 Click **Add To Array** to move the drives to a proposed drive group configuration in the **Drive Groups** pane.

If you need to undo the changes, click **Reclaim**.

Step 4 From the **Encryption** drop-down list, choose an encryption option.

Step 5 If needed, finish adding drives to the **Drive Groups** pane and click **Accept DG**.

Step 6 Click **Next**.

The **Virtual Drive Definition** window appears. This window lists the possible RAID levels for the drive group. Use this window to choose the RAID level, strip size, read policy, and other attributes for the new virtual drives.

Step 7 Choose the virtual drive options using the drop-down list in the left pane (the default values are shown).

- From the **RAID Level** drop-down list, choose the desired RAID option (RAID 0, 1, 5, or 6).

All of the possible RAID levels for the virtual drive are listed.

- From the **Strip Size** drop-down list, choose one of the following:
8, 16, 32, 64, 128, 256, 512, 1024 KB. The default is 64 KB.

The strip size is the portion of a stripe that resides on a single drive in the drive group. The stripe consists of the data segments that the RAID controller writes across multiple drives, not including parity drives.

For example, consider a stripe that contains 64 KB of drive space and has 16 KB of data residing on each drive in the stripe. In this case, the stripe size is 64 KB and the strip size is 16 KB. A larger strip size produces higher read performance. If your server regularly performs random read requests, choose a smaller strip size.

- From the **Access Policy** drop-down list, choose one of the following:
 - **RW**—Allows read/write access. This is the default.
 - **Read Only**—Allows read-only access.
 - **Blocked**—Does not allow access.
- From the **Read Policy** drop-down list, choose one of the following:
 - **Normal**—Disables the read-ahead capability. This is the default.
 - **Ahead**—Enables read-ahead capability, which allows the controller to read sequentially ahead of requested data and to store the additional data in cache memory, anticipating that the data will be needed soon. This option speeds up reads for sequential data but there is little improvement when accessing random data.
- From the **Write Policy** drop-down list, choose one of the following:
 - **WBack**—In Writeback mode, the controller sends a data transfer completion signal to the host when the controller cache has received all of the data in a transaction. This setting is recommended in Standard mode.
 - **WThru**—In Writethrough mode, the controller sends a data transfer completion signal to the host when the drive subsystem has received all of the data in a transaction. This is the default.
 - **Bad BBU**—Choose this mode if you want the controller to use Writeback mode, but the controller has no BBU or the BBU is bad. If you do not choose this option, the controller firmware automatically switches to Writethrough mode if it detects a bad or missing BBU.



Caution

The LSI WebBIOS CU allows Writeback mode to be used with or without a battery. We recommend that you use either a battery to protect the controller cache or an uninterruptable power supply (UPS) to protect the entire system. If you do not use a battery or a UPS, and there is a power failure, you risk losing the data in the controller cache.

- From the **IO Policy** drop-down list, choose one of the following:
 - **Direct**—In direct I/O mode, reads are not buffered in the cache memory. Data is transferred to the cache and the host concurrently. If the same data block is read again, it comes from the cache memory. This is the default.

- **Cached**—In cached I/O mode, all reads are buffered in the cache memory.

The IO Policy applies to reads on a specific virtual drive. It does not affect the read-ahead cache.

- From the **Drive Cache** drop-down list, choose one of the following:
 - **Enable**—Enables the drive cache.
 - **Disable**—Disables the drive cache.
 - **NoChange**—Leaves the current drive cache policy as is. This is the default.
- From the **Disable BGI** drop-down list, choose the background initialization status from the following:
 - **No**—Leaves background initialization enabled, which means that a new configuration can be initialized in the background while you use WebBIOS to do other configuration tasks. This is the default.
 - **Yes**—Does not allow background initializations for configurations on this controller.
- From the **Select Size** drop-down list, choose the size of the virtual drive in **MB**.
Normally, this would be the full size for RAID 0 shown in the Configuration pane. You can specify a smaller size if you want to create other virtual drives in the same drive group.

Step 8 Click **Accept** to accept the changes to the virtual drive definitions.

If you need to undo the changes, click **Reclaim**.

Step 9 After you finish the virtual drive definitions, click **Next**.

The **Configuration Preview** window appears.

Step 10 Check the virtual drive configuration in the **Configuration Preview** window and choose one of the following:

- If the virtual drive configuration is acceptable, click **Accept** to save the configuration.
- Click **Back** to return to the previous windows and change the configuration.

Step 11 Click **Yes** at the prompt to save the configuration.

The main **WebBIOS CU** window appears.

Using Manual Configuration (RAID 00, 10, 50, 60)

For more information about RAID levels, see [RAID Levels, page 1-7](#).

Step 1 Choose **Manual Configuration** and click **Next**.

The **Drive Group Definition** window appears. Use this window to choose drives to create drive groups.

Step 2 Press and hold **Ctrl** while choosing ready drives in the **Drives** pane.

Choose all of the drives for the drive group.

Step 3 Click **Add To Array** to move the drives to a proposed drive group configuration in the **Drive Groups** pane.

If you need to undo the changes, click **Reclaim**.

Step 4 If needed, finish adding drives to the **Drive Groups** pane and click **Accept DG** to create a RAID drive group.

An icon for the next drive group appears in the **Drive Groups** pane.

Step 5 Choose the drive group created in [Step 4](#), and press and hold **Ctrl** while choosing more ready drives in the **Drives** pane to create a second RAID drive group.

Step 6 Click **Add To Array** to move the drives to a second drive group configuration in the **Drive Groups** pane. If you need to undo the changes, click **Reclaim**.



Note RAID 00 supports a maximum of eight spans with a maximum of 32 drives per span.



Note RAID 10 supports a maximum of eight spans with a maximum of 32 drives per span. You must use an even number of drives in each RAID 10 drive group in the span.

Step 7 From the **Encryption** drop-down list, choose an encryption option.

Step 8 If needed, finish adding drives to the **Drive Groups** pane and click **Accept DG** to create a RAID 0 drive group.

Step 9 Repeat [Step 4](#) through [Step 6](#) until you have chosen all the drives you want for the drive groups.

Step 10 After you finish adding drives to the **Drive Groups** pane, choose each drive group, and click **Accept DG** after each drive group choice.

Step 11 Click **Next**.

The **Span Definition** window appears. This window shows the drive group holes that you can choose to add to the **Span** pane.

Step 12 Press and hold **Ctrl** while you choose a drive group in the **Array With Free Space** pane, and click **Add to SPAN**.

The drive group you chose appears in the **Span** pane.

Step 13 Press and hold **Ctrl** while you choose a second drive group, and click **Add to SPAN**.

Step 14 Repeat [Step 12](#) and [Step 13](#) until you have chosen all of the drive groups that you need.

Step 15 Click **Next**.

The **Virtual Drive Definition** window appears. This window lists the possible RAID levels for the drive group. Use this window to choose the RAID level, strip size, read policy, and other attributes for the new virtual drives.

Step 16 Press and hold **Ctrl** to choose the drive group in the **Configuration** pane, and then choose the virtual drive options using the drop-down lists in the left pane (the default values are shown):

- From the **RAID Level** drop-down list, choose The desired RAID level (RAID 00, 10, 50, or 60).

All of the possible RAID levels for the virtual drive are listed.

- From the **Strip Size** drop-down list, choose one of the following:
8, 16, 32, 64, 128, 256, 512, 1024 KB. The default is 64 KB.

The strip size is the portion of a stripe that resides on a single drive in the drive group. The stripe consists of the data segments that the RAID controller writes across multiple drives, not including parity drives.

For example, consider a stripe that contains 64 KB of drive space and has 16 KB of data residing on each drive in the stripe. In this case, the stripe size is 64 KB and the strip size is 16 KB. A larger strip size produces higher read performance. If your server regularly performs random read requests, choose a smaller strip size.

- From the **Access Policy** drop-down list, choose one of the following:

- **RW**—Allows read/write access. This is the default.
- **Read Only**—Allows read-only access.
- **Blocked**—Does not allow access.
- From the **Read Policy** drop-down list, choose one of the following:
 - **Normal**—Disables the read-ahead capability. This is the default.
 - **Ahead**—Enables read-ahead capability, which allows the controller to read sequentially ahead of requested data and to store the additional data in cache memory, anticipating that the data will be needed soon. This speeds up reads for sequential data but there is little improvement when accessing random data.
- From the **Write Policy** drop-down list, choose one of the following:
 - **WBack**—In Writeback mode, the controller sends a data transfer completion signal to the host when the controller cache has received all of the data in a transaction. This setting is recommended in Standard mode.
 - **WThru**—In Writethrough mode, the controller sends a data transfer completion signal to the host when the drive subsystem has received all of the data in a transaction. This is the default.
 - **Bad BBU**—Choose this mode if you want the controller to use Writeback mode but the controller has no BBU or the BBU is bad. If you do not choose this option, the controller firmware automatically switches to Writethrough mode if it detects a bad or missing BBU.

**Caution**

LSI allows Writeback mode to be used with or without a battery. LSI recommends that you use *either* a battery to protect the controller cache or an uninterruptable power supply (UPS) to protect the entire system. If you do not use a battery or a UPS, and there is a power failure, you risk losing the data in the controller cache.

- From the **IO Policy** drop-down list, choose one of the following:
 - **Direct**—In direct I/O mode, reads are not buffered in the cache memory. Data is transferred to the cache and the host concurrently. If the same data block is read again, it comes from the cache memory. This is the default.
 - **Cached**—In cached I/O mode, all reads are buffered in the cache memory.

The IO Policy applies to reads on a specific virtual drive. It does not affect the read-ahead cache.
- From the **Drive Cache** drop-down list, choose one of the following:
 - **Enable**—Enables the drive cache.
 - **Disable**—Disables the drive cache.
 - **NoChange**—Leaves the current drive cache policy as is. This is the default.
- From the **Disable BGI** drop-down list, choose the background initialization status from the following:
 - **No**—Leaves background initialization enabled, which means that a new configuration can be initialized in the background while you use WebBIOS to do other configuration tasks. This is the default.
 - **Yes**—Does not allow background initializations for configurations on this controller.
- From the **Select Size** drop-down list, choose the size of the virtual drive in **MB**.
Normally, this would be the full size for RAID 00 shown in the Configuration pane. You can specify a smaller size if you want to create other virtual drives in the same drive group.

- Step 17** Click **Accept** to accept the changes to the virtual drive definitions.
If you need to undo the changes, click **Reclaim**.
- Step 18** After you finish the virtual drive definitions, click **Next**.
The **Configuration Preview** window appears.
- Step 19** Check the virtual drive configuration in the **Configuration Preview** window and choose one of the following:
- If the virtual drive configuration is acceptable, click **Accept** to save the configuration.
 - Click **Back** to return to the previous windows and change the configuration.
- Step 20** Click **Yes** at the prompt to save the configuration.
The main **WebBIOS CU** window appears.
-

Viewing and Changing Device Properties

This section describes how you can use the WebBIOS CU to view and change the properties for controllers, virtual drives, physical drives, and BBUs.

Viewing Controller Properties

WebBIOS displays information for one LSI SAS controller at a time. If your computer system has multiple LSI SAS controllers, you can view information for a different controller by clicking **Controller Selection** in the main window. When the Controller Selection window appears, choose the controller you want from the list.

To view the properties of the current controller, follow these steps:

-
- Step 1** Click **Controller Properties** in the main **WebBIOS CU** window.
- There are three Controller Properties windows. The information in the first window is read-only and cannot be modified directly. The window lists the number of virtual drives that are already defined on this controller and the number of drives connected to the controller.
- Step 2** Click **Next** to view the second **Controller Properties** window.
- Step 3** Click **Next** to view the third **Controller Properties** window.
- [Table 5-1](#) describes the entries and options listed in the second and third Controller Properties windows. LSI recommends that you leave these options at their default settings to achieve the best performance, unless you have a specific reason for changing them.
- Step 4** If you make changes to the options on these windows, click **Submit** to register them. If you change your mind, click **Reset** to return the options to their default values.
-

Table 5-1 Controller Properties Menu Options

Option	Description
Battery Backup	Indicates whether the chosen controller has a BBU. If present, you can click Present to view information about the BBU. For more information, see Viewing and Changing Device Properties, page 5-11 .
Set Factory Defaults	Loads the default MegaRAID WebBIOS CU settings. The default is No.
Rebuild Rate	Chooses the rebuild rate for drives connected to the chosen controller. The default is 30 percent. The rebuild rate is the percentage of system resources dedicated to rebuilding a failed drive. The higher the number, the more system resources are devoted to a rebuild.
BGI Rate	Chooses the amount of system resources dedicated to background initialization of virtual drives connected to the chosen controller. The default is 30 percent.
CC Rate	Chooses the amount of system resources dedicated to consistency checks of virtual drives connected to the chosen controller. The default is 30 percent.
Reconstruction Rate	Chooses the amount of system resources dedicated to reconstruction of drives connected to the chosen controller. The default is 30 percent.
Controller BIOS	Enables or disables the BIOS for the chosen controller. The default is Enabled. If the boot device is on the chosen controller, the BIOS must be enabled. Otherwise, the BIOS should be disabled or it might not be possible to use a boot device elsewhere.
NCQ	Native Command Queuing (NCQ) gives an individual drive the ability to optimize the order in which it executes the read and write commands. The default is Enabled.
Coercion Mode	Drive coercion is a tool for forcing drives of varying capacities to the same size so they can be used in a drive group. The coercion mode options are None, 128MB-way, and 1GB-way. The default is None. The number you choose depends on how much the drives from various vendors vary in their actual size. LSI recommends that you use the 1-GB coercion mode option.
SMART Polling	Determines how frequently the controller polls for drives reporting a Predictive Drive Failure (SMART: Self-Monitoring Analysis and Reporting Technology error). The default is 300 seconds (5 minutes).
Alarm Control	Enables, disables, or silences the onboard alarm tone generator on the controller. The default is Disabled.
Patrol Read Rate	Chooses the rate for patrol reads for drives connected to the chosen controller. The default is 30 percent. The patrol read rate is the percentage of system resources dedicated to running a patrol read. See “Patrol Read-Related Controller Properties” in the Chapter 5 of the <i>LSI MegaRAID Software User Guide</i> for additional information about patrol read.
Cache Flush Interval	Controls the interval (in seconds) at which the contents of the onboard data cache are flushed. The default is 4 seconds.
Spinup Drive Count	Controls the number of drives that spin up simultaneously. The default is 2 drives.

Table 5-1 Controller Properties Menu Options (continued)

Option	Description
Spinup Delay	Controls the interval (in seconds) between the spinup of drives connected to this controller. The delay prevents a drain on the system power supply that would occur if all drives spun up at the same time. The default is 12 seconds.
StopOnError	When enabled, this option stops the boot process when the controller BIOS encounters an error during boot-up. The default is Disabled.
Spin Down Delay Time	Controls the interval (in seconds) between the spindown of drives connected to this controller. The delay prevents a drain on the system's power supply that would occur if all drives spun down at the same time. The default is 30 minutes.
Stop CC on Error	When enabled, this option stops a consistency check when the controller BIOS encounters an error. The default is No.
Maintain PD Fail History	Maintains the history of all drive failures. The default is Disabled.
Schedule CC	Indicates whether the option to schedule the date and time for a consistency check is supported.

Viewing Virtual Drive Properties, Policies, and Operations

Step 1 Click the **Virtual Drives** icon in the right pane in the main **WebBIOS CU** window.

The **Virtual Drive** window displays the following information:

- **Properties** area—Displays the virtual drive's RAID level, state, capacity, and strip size information.
- **Policies** area—Lists the virtual drive policies that were defined when the storage configuration was created. For information about these policies, see [Using Manual Configuration, page 5-6](#).
 - Choose an option from any of the drop-down lists and click **Change** to change any of these policies.
- **Operations** area—Lists operations that can be performed on the virtual drive.

Choose from the following options and click **Go** to perform an operation:

- **Delete**—Deletes this virtual drive. For more information, see [Deleting a Virtual Drive, page 5-18](#).
- **Fast Init**—Initializes this virtual drive. A fast initialization quickly writes zeroes to the first and last 10-MB regions of the new virtual drive and completes the initialization in the background.
- **Slow Init**—Initializes this virtual drive. A slow initialization is not complete until the entire virtual drive has been initialized with zeroes. It is seldom necessary to use this option, because the virtual drive was already initialized when you created it.



Caution

Before you run an initialization, back up any data on the virtual drive that you want to save. All data on the virtual drive is lost when you initialize the drive.

- **CC**—Runs a consistency check on this virtual drive. For more information, see [Using Manual Configuration, page 5-6](#). (This option is not available for RAID 0 virtual drives.)

- **AdvOpers**—Accesses windows to remove drives, migrates RAID levels (that is, changes the virtual drive configuration by adding a drive and changing the RAID level).

See [Migrating the RAID Level of a Virtual Drive, page 5-20](#) for information about adding a drive to a virtual drive or migrating its RAID level.

- **Expand**—Increases the size of a virtual drive to occupy the remaining capacity in the drive group. In addition, you can add drives to the virtual drive to increase the capacity.



Note Drives can be added to a drive group only when there is a *single* virtual drive present on the drive group. If there are multiple virtual drives present on the drive group, the option to add an extra disk is not available.

See [Expanding a Virtual Drive, page 5-16](#) for the procedure you can use to expand a virtual drive.



Caution

Before you change a virtual drive configuration, back up any data on the virtual drive that you want to save.

Viewing Physical Drive Properties and Operations

The Physical Drive window displays the properties of a chosen drive and then enables you to perform operations on the drive.

To view drive properties and perform subsequent operations, follow these steps:

- Step 1** To access the **Physical Drive** window, choose one of the following options:
- In the main **WebBIOS CU** window, in the **Physical Drives** area (in the right side), click a drive. The **Physical Drive** window appears.
 - In the main **WebBIOS CU** window, click **Physical Drives** in the left pane. Then click a drive in the right pane. The **Physical Drive** window appears.

- Step 2** Click **Properties**, and click **Go**. The drive properties window for the chosen drive appears.

The drive properties are view-only and include the state of the drive.

- Step 3** If the drive state is **Online**, choose one of the following operations and click **Go**:

- **MakeDriveOffline**—Forces the drive offline.



Note If you force offline a good drive that is part of a redundant drive group with a hot spare, the drive rebuilds to the hot spare drive. The drive you forced offline goes into the Unconfigured Bad state. Access the BIOS utility to set the drive to the Unconfigured Good state.

- **Locate**—Makes the LED flash on the drive, which works only if the drive is installed in a drive enclosure.

- Step 4** If the drive state is **Unconfigured Good**, choose one of the four following operations and click **Go**:

- **Make Global HSP**—Makes a global hot spare available to all of the virtual drives.
- **Make Dedicated HSP**—Makes a hot spare dedicated to a specific virtual drive.

WebBIOS displays the global hot spare as **Global** and the dedicated hot spare as **Ded**. The icon for the dedicated hot spare displays under its associated virtual drive. The drive number, drive state, drive capacity, and drive manufacturer display.

- **Enclosure Affinity**—Specifies where the hot spare is used first.

If there are drive failures present on a split backplane configuration, then the hot spare will be used first on the backplane side that it resides in.

- **Prepare for Removal**—Prepares the drive for removal from the enclosure.

The **Prepare for Removal** feature is different from spinning a drive down into powersave mode, because it also involves flagging the drive as ready to remove. Therefore, if you choose to prepare a drive for removal, **Ready to Remove** displays in the device tree for that drive, instead of **Powersave**.

Viewing and Changing Battery Backup Unit Information

If your SAS controller has a battery backup unit (BBU), you can view information and change settings.

Step 1 Click **Controller Properties** in the main **WebBIOS CU** window. The first **Controller Information** window appears.

Step 2 Click **Next** to view the second **Controller Properties** window.

The second **Controller Properties** window appears. The **Battery Backup** field indicates whether the BBU is present.

Step 3 Click **Present** in the **Battery Backup** field.

The **Battery Module** window appears. This window contains the following information:

- Battery information
- Design information
- Capacity information
- Auto Learn properties and settings

Most of the Battery Module properties are view-only and are self-explanatory.

In the lower right corner of the window are the auto learn options. A *learning cycle* is a battery calibration operation performed by the controller periodically to determine the condition of the battery. You can change the learn delay interval (the length of time between automatic learning cycles) and the auto learn mode.



Note

LSI recommends leaving the learn delay interval and the auto learn mode at their default settings.

Managing RAID

This section includes information about maintaining and managing storage configurations.

Expanding a Virtual Drive

You can increase the size of a virtual drive to occupy the remaining capacity in a drive group. In addition, you can add drives to the virtual drive to increase capacity.



Note Drives can be added to a drive group only when there is a *single* virtual drive present on the drive group. If there are multiple virtual drives present on the drive group, the option to add an extra disk is not available.

-
- Step 1** Click a virtual drive icon in the right pane of the main **WebBIOS CU** window to access the **Virtual Drive** window. The **Virtual Drive** window appears.
 - Step 2** Choose the **Expand** radio button and click **Go**. The **Expand Virtual Drive** window appears.
 - Step 3** Enter the percentage of the available capacity that you want the virtual drive to use.
For example, if 100 GB capacity is available and you want to increase the size of the virtual drive by 30 GB, choose 30 percent.
 - Step 4** Click **Calculate** to determine the capacity of the virtual drive after expansion.
 - Step 5** Click **Ok**. The virtual drive expands by the chosen percentage of the available capacity.
-

Monitoring Array Health

You should periodically run a consistency check on fault-tolerant virtual drives. A consistency check verifies that the redundancy data is correct and available for RAID 1, RAID 5, RAID 6, RAID 10, RAID 50, and RAID 60 drive groups.

-
- Step 1** In the main WebBIOS CU window, choose a virtual drive.
 - Step 2** Click **Virtual Drives**.
 - Step 3** When the **Virtual Drive** window appears, click the **CC** radio button, and click **Go**.
The consistency check begins.



Note If the WebBIOS CU finds a difference between the data and the parity value on the redundant drive group, it assumes that the data is accurate and automatically corrects the parity value. Be sure to back up the data before running a consistency check if you think the data might be corrupted.

Recovery

MegaRAID Recovery, also known as Snapshot, offers a simplified way to recover data and provides automatic protection for the boot volume. You can use the Recovery feature to take a snapshot of a volume and to restore a volume or file. Snapshot functionality allows you to capture data changes to the volume, and, if data is deleted accidentally or maliciously, you can restore the data from the view or roll back to a snapshot at a previous point-in-time (PiT). MegaRAID Recovery supports up to eight snapshots of PiTs for each volume.

Each Recovery PiT volume snapshot is typically a fraction of the original volume size, because it tracks only the changes that are made to a volume after the PiT is created. The disk space for PiTs is reserved in the Snapshot Repository virtual drive, and the PiT is expanded in small increments as new data is written to the volume. Multiple PiTs of each volume can be retained online, enabling frequent snapshots to be stored in a space-efficient manner.

**Caution**

Do not select the virtual drive containing the operating system (OS) as the Snapshot Repository. Updates to the operating system or operating system crashes could destroy data on that virtual drive.

Three primary scenarios in which to use the Recovery feature are as follows:

1. Restore the missing or deleted files (restore from view).
 - a. Discover that files are missing or deleted.
 - b. Review the Snapshot views of the file content (also known as “mounting” a snapshot) from each PiT until you find the missing file.

A Snapshot view contains the content from the Point-in-Time at which the snapshot was made.
 - c. Drag and drop the missing file from the Snapshot view back into the online storage volume that was the source of the Snapshot.
2. If there are corrupt operating system files in a volume, roll back the volume to a previous state:
 - a. Reboot the system and run WebBIOS.
 - b. Select the most recent snapshot that does not contain the corrupted or malicious file to roll back to. Select the most recent PiT snapshot to roll back to.
 - c. Reboot the system.

The system automatically rolls back to its previous state based on the selected PiT snapshot.
3. Reduce the risk of extended downtime during application updates/upgrades in the IT center:
 - a. When the application is offline, take a snapshot of the application volume.
 - b. Install each patch individually and test for any new defects that might have been introduced.
 - c. Take a snapshot after you test each patch and determine that it is clean.
 - d. If a defect is introduced, roll back to the previous installation and bypass the installation of the defective patch.

**Note**

If the volume is still damaged, continue to select from the next most current PiT snapshot to the oldest.

You can enable the Recovery advanced software in WebBIOS. After you enable Recovery, you create two virtual drives: one as a Snapshot Base or source and the other as a Snapshot Repository. The Snapshot Base virtual drive contains the data that is stored in the repository virtual drive.

Deleting a Virtual Drive

You can delete any virtual drive on the controller if you want to reuse that space for a new virtual drive. The WebBIOS CU provides a list of configurable drive groups where there is a space to configure. If multiple virtual drives are defined on a single drive group, you can delete a virtual drive without deleting the whole drive group.



Caution

Back up any data that you want to keep before you delete the virtual drive.

-
- Step 1** Click a virtual drive icon in the right pane in the main **WebBIOS CU** window to access the **Virtual Drive** window. The **Virtual Drive** window appears.
- Step 2** Click the **Delete** radio button in the **Operations** area, and click **Go**.
- Step 3** When the message appears, confirm that you want to delete the virtual drive.
-

Migrating an Array to a New Server

A *foreign configuration* is a storage configuration that already exists on a set of drives that you install in a server. To migrate an existing array from one server to another, as in the case of a server replacement, the new server must have the same controller type as the server on which the array was initially created.

In addition, if one or more drives are removed from a configuration, by a cable pull or drive removal, for example, the configuration on those drives is considered a foreign configuration by the RAID controller.

The BIOS CU allows you to import the foreign configuration to the RAID controller, or to clear the configuration so you can create a new configuration using these drives.



Note

When you create a new configuration, the WebBIOS CU shows only the unconfigured drives. Drives that have existing configurations, including foreign configurations, do not appear. To use drives with existing configurations, you must first clear the configuration on those drives.

If WebBIOS CU detects a foreign configuration, the Foreign Configuration window appears.

-
- Step 1** In the **Foreign Configuration** window, click the **Select Configuration** drop-down list to show the configurations.
- The GUID (Global Unique Identifier) entries in the drop-down list are OEM names and will vary from one installation to another.
- Step 2** Choose a configuration or **All Configurations**.
- Step 3** To preview or clear a foreign configuration, do one of the following:
- Click **Preview** to preview the foreign configuration. The **Foreign Configuration Preview** window appears.
 - Click **Clear** to clear the foreign configuration and reuse the drives for another virtual drive.
- If you click **Cancel**, it cancels the importation or preview of the foreign configuration.

The right pane shows the virtual drive properties of the foreign configuration. The left pane shows the drives in the foreign configuration.

- Step 4** Click **Import** to import this foreign configuration and use it on this controller.
If you click **Cancel**, you return to the **Foreign Configuration** window.
-

Foreign Configurations in Cable Pull and Drive Removal Scenarios

If one or more drives are removed from a configuration, for example, by a cable pull or drive removal, the configuration on those drives is considered a foreign configuration by the RAID controller.

Use the **Foreign Configuration Preview** window to import or clear the foreign configuration in each case. The import procedure and clear procedure are described in [Migrating an Array to a New Server, page 5-18](#).

**Note**

If you want to import the foreign configuration in any of the following scenarios, you should have all of the drives in the enclosure before you perform the import operation.

The following scenarios can occur with cable pulls or drive removals:

- Scenario 1: If all of the drives in a configuration are removed and reinserted, the controller considers the drives to have foreign configurations.

Import or clear the foreign configuration. If you choose **Import**, automatic rebuilds occur in redundant virtual drives.

**Note**

Start a consistency check immediately after the rebuild is complete to ensure data integrity for the virtual drives.

- Scenario 2: If some of the drives in a configuration are removed and reinserted, the controller considers the drives to have foreign configurations.

Import or clear the foreign configuration. If you choose **Import**, automatic rebuilds occur in redundant virtual drives.

**Note**

Start a consistency check immediately after the rebuild is complete to ensure data integrity for the virtual drives.

- Scenario 3: If all of the drives in a virtual drive are removed, but at different times, and reinserted, the controller considers the drives to have foreign configurations.

Import or clear the foreign configuration. If you choose **Import**, all drives that were pulled *before* the virtual drive became offline are imported and automatically rebuilt. Automatic rebuilds occur in redundant virtual drives.

- Scenario 4: If the drives in a nonredundant virtual drive are removed, the controller considers the drives to have foreign configurations.

Import or clear the foreign configuration. No rebuilds occur after the import operation because there is no redundant data with which to rebuild the drives.

Importing Foreign Configurations from Integrated RAID to MegaRAID

The LSI Integrated RAID solution simplifies the configuration options and provides firmware support in its host controllers. LSI offers two types of Integrated RAID (IR): Integrated Mirroring (IM) and Integrated Striping (IS).

You can import an IM or IS RAID configuration from an IR system into a MegaRAID system. The MegaRAID system treats the IR configuration as a foreign configuration. You can import or clear the IR configuration.

**Note**

For more information about Integrated RAID, see [Chapter 4, “Configuring the LSI SAS2 Integrated RAID Controller.”](#)

Troubleshooting Information

An IR virtual drive can have either 64 MB or 512 MB available for metadata at the end of the drive. This data is in LSI Data Format (LDF). MegaRAID virtual drives have 512 MB for metadata at the end of the drive in the Disk Data Format (DDF).

To import an IR virtual drive into MegaRAID, the IR virtual drive must have 512 MB in the metadata, which is the same amount of metadata as in a MegaRAID virtual drive. If the IR virtual drive has only 64 MB when you attempt to import it into MegaRAID, the import fails because the last 448 MB of your data is overwritten and the data is lost.

If your IR virtual drive has only 64 MB for metadata at the end of the drive, you cannot import the virtual drive into MegaRAID. You need to use another upgrade method, such as backup/restore to the upgraded virtual drive type.

To import an IR virtual drive into a MegaRAID system, use the **Foreign Configuration Preview** window to import or clear the foreign configuration. The import procedure and the clear procedure are described in [Migrating an Array to a New Server, page 5-18](#).

Migrating the RAID Level of a Virtual Drive

As the amount of data and the number of drives in your system increase, you can use RAID-level migration to change a virtual drive from one RAID level to another. You do not have to power down or reboot the system. When you migrate a virtual drive, you can keep the same number of drives, or you can add drives. You can use the WebBIOS CU to migrate the RAID level of an existing virtual drive.

**Note**

While you can apply RAID-level migration at any time, LSI recommends that you do so when there are no reboots. Many operating systems issue I/O operations serially (one at a time) during boot. With a RAID-level migration running, a boot can often take more than 15 minutes.

Migrations are allowed for the following RAID levels:

- RAID 0 to RAID 1
- RAID 0 to RAID 5
- RAID 0 to RAID 6
- RAID 1 to RAID 0
- RAID 1 to RAID 5

- RAID 1 to RAID 6
- RAID 5 to RAID 0
- RAID 5 to RAID 6
- RAID 6 to RAID 0
- RAID 6 to RAID 5

Table 5-2 lists the number of additional drives required when you change the RAID level of a virtual drive.

Table 5-2 Additional Drives Required for RAID-Level Migration

From RAID Level to RAID Level	Original Number of Drives in the Drive Group	Additional Drives Required
RAID 0 to RAID 1	RAID 0: 1 drive	1
RAID 0 to RAID 5	RAID 0: 1 drive	2
RAID 0 to RAID 6	RAID 0: 1 drive	3
RAID 1 to RAID 5	RAID 1: 2 drives	1
RAID 1 to RAID 6	RAID 1: 2 drives	1



Caution

Back up any data that you want to keep before you change the RAID level of the virtual drive.

- Step 1** In the main **WebBIOS CU** window, choose a virtual drive.
- Step 2** Click **Virtual Drives**. The **Virtual Drive** window appears.
- Step 3** Click the **AdvOpers** radio button. The **Advanced Operations** window appears.
- Step 4** Choose either **Change RAID Level** or **Change RAID Level and Add Drive**.
- If you choose **Change RAID Level**, change the RAID level from the drop-down list.
 - If you choose **Change RAID Level and Add Drive**, change the RAID level from the drop-down list and choose one or more drives to add from the list of drives.

The available RAID levels are limited, based on the current RAID level of the virtual drive plus the number of drives available.

- Step 5** Click **Go**.
- Step 6** When the message appears, confirm that you want to migrate the RAID level of the virtual drive.

A reconstruction operation begins on the virtual drive. You must wait until the reconstruction is completed before you perform any other tasks in the WebBIOS CU.

Determining Which Controller is in Your Server

There is a dedicated SAS riser slot for the RAID controller card in a C-series chassis. There is also a mounting point inside the chassis for the optional RAID battery backup unit that is available when using the appropriate LSI controller.

Supported RAID controllers for all models are listed in [RAID Controllers in UCS Servers, page 3-10](#).

If you do not have a record of which option is used in your server, you can read the on-screen messages that are displayed during system bootup

Information about the card models installed are displayed as part of the verbose boot. You are also prompted to press **Ctrl-H** to launch configuration utilities for those cards. For servers running CIMC firmware earlier than release 1.2(1), see also [Disabling Quiet Boot for CIMC Firmware Earlier than Release 1.2\(1\), page 5-22](#).

Disabling Quiet Boot for CIMC Firmware Earlier than Release 1.2(1)

For CIMC firmware and BIOS release 1.2(1) and later releases, Quiet Boot has been removed and is no longer needed. If you are running CIMC firmware and BIOS earlier than release 1.2(1), you can use the following procedure to disable Quiet Boot.

-
- Step 1** Boot the server and watch for the F2 prompt.
- Step 2** Press **F2** when prompted to enter the BIOS Setup utility.
- Step 3** On the Main page of the BIOS Setup utility, set Quiet Boot to **Disabled**.
- This action allows non default messages, prompts, and POST messages to display during bootup instead of the Cisco logo window.
- Step 4** Press **F10** to save your changes, and to exit the utility.
-

Launching an Option ROM-Based Controller Utility

To alter the RAID configurations on your hard drives, you can use your host-based utilities that you install on top of your host OS, or you can use the LSI option ROM-based utilities that are installed on the server.

When you boot the server and you have quiet boot disabled, information about your controller is displayed. The prompts for the key combination to launch the option ROM-based utilities for your controller are also displayed.

-
- Step 1** Watch for the prompt for your controller during verbose boot:
- Step 2** Press **Ctrl-H** for the LSI controller utility.
-



Note

Cisco has also developed the Cisco Server Configuration Utility for C-Series servers, which can assist you in setting up some RAID configurations for your drives. This utility is shipped with new servers on CD. You can also download the ISO from Cisco.com. See the user documentation for this utility at the following URL:

http://www.cisco.com/en/US/docs/unified_computing/ucs/sw/ucsscu/user/guide/20/SCUUG20.html

LSI MegaRAID Card Beep Codes

Table 5-3 contains a summary of the LSI MegaRAID card beep codes. These beep codes indicate activity and changes from the optimal state of your RAID array. For full documentation on the LSI MegaRAID cards and the LSI utilities, refer to the LSI documentation for your card.

Table 5-3 Summary of LSI MegaRAID Card Beep Codes

Beep Code	LSI Firmware State	Cause (Depending on RAID Level)
3 seconds on, 1 second off	SPEAKER_OFFLINE_ENTRY	<ul style="list-style-type: none"> RAID 0: One or more drives offline. RAID 1: Two drives offline. RAID 5: Two or more drives offline. RAID 6: More than two drives offline.
1 second on, 1 second off	SPEAKER_DEGRADED_ENTRY	<ul style="list-style-type: none"> RAID 1: A mirrored drive failed. RAID 5: One drive failed. RAID 6: One or two drives failed.
1 second on, 3 seconds off	SPEAKER_HOTSPARE_ENTRY	A hot spare drive has completed the rebuild process and has been brought into the array.

Restoring the RAID Configuration After Replacing a RAID Controller

When you replace a RAID controller, the RAID configuration that is stored in the controller is lost. Use the following procedure to restore your RAID configuration to your new RAID controller.

-
- Step 1** Replace your RAID controller. See your server documentation for specific steps.
- Step 2** If you are performing a full chassis swap, replace all drives into the drive bays, in the same order that they were installed in the old chassis.
- Step 3** If Quiet Boot is enabled, disable it in the system BIOS. See [Disabling Quiet Boot for CIMC Firmware Earlier than Release 1.2\(1\)](#), page 5-22.
- Step 4** Reboot the server and watch for the message to press F.
- Step 5** Press **F** when you see the following on-screen message:
- ```
Foreign configuration(s) found on adapter.
Press any key to continue or 'C' load the configuration utility,
or 'F' to import foreign configuration(s) and continue.
```
- Step 6** Press any key (other than C) to continue when you see the following on-screen message:
- ```
All of the disks from your previous configuration are gone. If this is
an unexpected message, then please power of your system and check your cables
to ensure all disks are present.
Press any key to continue, or 'C' to load the configuration utility.
```

Step 7 Watch the subsequent windows for confirmation that your RAID configuration was imported correctly.

- If you see the following message, your configuration was successfully imported. The LSI virtual drive is also listed among the storage devices.

```
N Virtual Drive(s) found on host adapter.
```

- If you see the following message, your configuration was not imported which can happen if you do not press F quickly enough when prompted. In this case, reboot the server and try the import operation again when you are prompted to press F.

```
0 Virtual Drive(s) found on host adapter.
```



CHAPTER 6

Configuring the Embedded ICH10R SATA Controller

This chapter describes how to use the LSI Software RAID Setup Utility to configure the onboard Intel ICH10R RAID controller.

This chapter contains the following sections:

- [Enabling the Integrated Intel ICH10R RAID Controller in the BIOS, page 6-1](#)
- [Launching the LSI Software RAID Setup Utility, page 6-1](#)
- [Configuring the Onboard Intel ICH10R RAID Controller, page 6-2](#)

Enabling the Integrated Intel ICH10R RAID Controller in the BIOS



Note

The integrated ICH10R RAID controller is not compatible for use with VMWare ESX/ESXi Server software in any generation or version of the Cisco UCS C200 or C210 servers.

- Step 1** Boot the server and press **F2** when prompted to enter the BIOS Setup utility.
 - Step 2** Choose the **Advanced** tab, and then choose **Mass Storage Controllers Configuration**.
 - Step 3** Set **Onboard SATA Controller** to **Enabled**.
 - Step 4** Set **SATA Mode** to **SW RAID**.
 - Step 5** Press **F10** to save your changes and exit the utility.
-

Launching the LSI Software RAID Setup Utility

To launch the LSI Software RAID Setup Utility which is used to manage the onboard Intel ICH10R controller, follow these steps:

- Step 1** Press **Ctrl-M** during verbose boot to run LSI Software RAID Setup Utility.
The main Setup Utility window appears as shown in [Figure 6-1](#).

Figure 6-1 Main Setup Utility Window

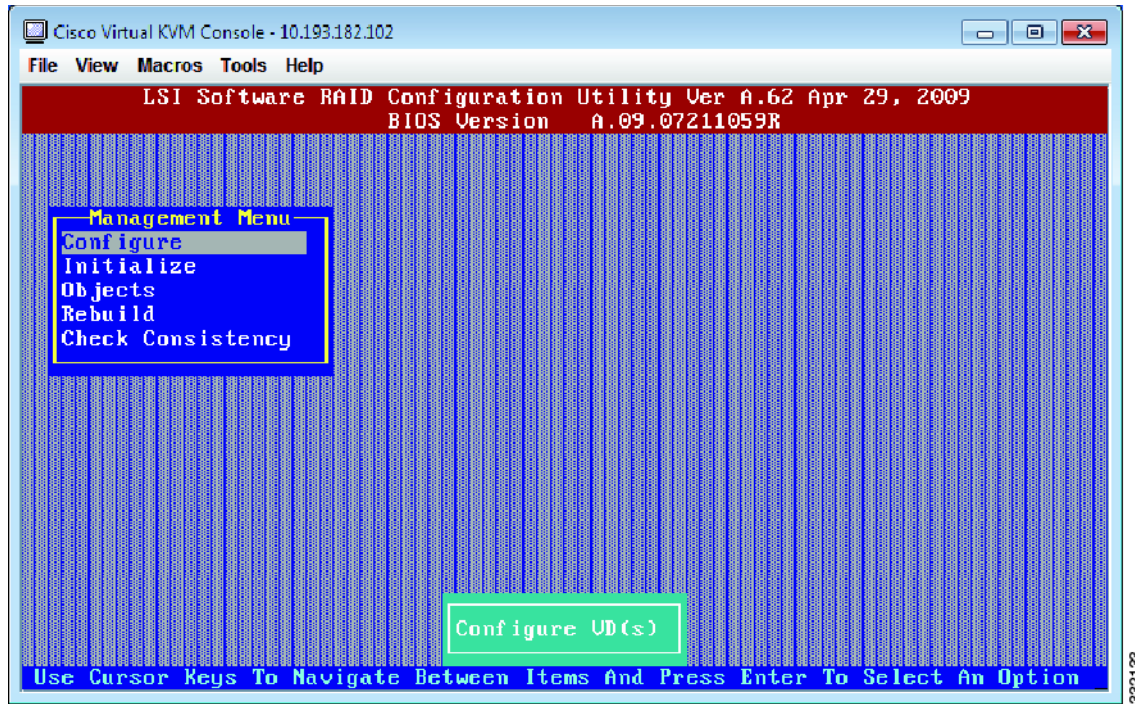

Configuring the Onboard Intel ICH10R RAID Controller

Step 1 Choose one of the following options to begin configuration:

- **New Configuration** and go to [Creating a New RAID Configuration, page 6-3](#) or [Viewing or Changing a RAID Configuration, page 6-4](#).

New Configuration settings allow you to clear an existing configuration of a drive or to configure a new RAID setting.



Caution

If you choose **New Configuration**, and choose **Yes** to proceed, all existing arrays and logical drives are replaced with your new configuration. If you want to keep the existing data, use **View/Add Configuration** instead.

- **View/Add Configuration** and go to [Viewing or Changing a RAID Configuration, page 6-4](#).

View/Add Configuration settings allow you to modify an existing configuration of a drive or to modify a RAID setting.

Creating a New RAID Configuration

Step 1 Choose **Configure** and press **Enter**.

Step 2 Choose **New Configuration** and choose **Yes**.



Caution

If you choose **New Configuration** and choose **Yes** to proceed, all existing arrays and logical drives will be replaced with your new configuration. If you want to keep the existing data, use **View/Add Configuration** instead.

The **New Configuration — ARRAY SELECTION MENU** window appears.

Step 3 Use the arrow keys to choose a drive and press **Spacebar** to add each drive to the new array.



Note

When you choose a drive, the status changes from **READY** to **ONLIN A[array number]-[drive number]**. For example, **ONLIN A00-01** means array 0, disk 1.



Note

To clear the selection, press **Spacebar** again.
To display the **Physical Drive Information** window, press **F2**.
To display the **Virtual Drive(s) Configured** window, press **F3**.

Step 4 Configure a single RAID array or multiple RAID arrays by following one of these options:

- To configure a single RAID array, choose all of the drives that you want for the first array, press **Enter**, and go to [Step 5](#).
- To configure multiple arrays, do the following:
 - Choose all of the drives that you want for the first array and press **Enter**.
 - Repeat for each array. When all of the drives for all arrays have been chosen, go to [Step 5](#).

Step 5 Press **F10** to begin to choose the RAID level for the array.

The **Select Configurable Array (s)** window appears.

Step 6 Press **Spacebar** to choose an array, for example, **SPAN-1**.

Step 7 Press **F10**.

The **Virtual Drive(s) Configured** window, **Virtual Drive #** window, and **Raid Level** window appear.

Step 8 Choose the RAID level and press **Enter**.



Note

The number of available RAID levels displayed depend on the specified number of hard disks.

The **New Configuration — ARRAY SELECTION MENU** window appears.



Note

Do not change any settings other than the RAID level.

Step 9 Repeat [Step 5](#) through [Step 8](#) to continue configuring the RAID levels for each array.

Step 10 Press **Enter** to complete the configuration using New Configuration settings.

- Step 11** A **Save Configuration** message appears.
- Step 12** Press **Enter**.
- Step 13** The array configuration finishes and a message **Configuration Is Saved Press Any Key To Continue** appears.
- Step 14** Press any key to exit the LSI Software RAID Setup Utility.

Viewing or Changing a RAID Configuration

- Step 1** Choose **Configure** and press **Enter**.
- Step 2** Choose **View/Add Configuration** and choose **Yes**.



Note The existing storage configuration is erased only if you save the newly modified configuration at the end of the process. If you do not save the modified configuration, the Setup Utility restores the previous configuration.

The **View/Add Configuration — ARRAY SELECTION MENU** window appears.

- Step 3** Use the arrow keys to choose a drive and press **Spacebar**.



Note When you choose a drive, the status changes from **READY** to **ONLIN A**[array number]-[drive number]. For example, **ONLIN A00-01** means array 0, disk 1.



Note To clear the selection, press **Spacebar** again.
To display the **Physical Drive Information** window, press **F2**.
To display the **Virtual Drive(s) Configured** window, press **F3**.

- Step 4** Press **F10** to begin to choose the RAID level for the array.
The **Select Configurable Array (s)** window appears.
- Step 5** Press **Spacebar** to choose an array, for example; **SPAN-1**.
- Step 6** Press **F10**.
The **Virtual Drive(s) Configured** window, **Virtual Drive #** window, and **Raid Level** window appear.
- Step 7** Choose one of the following options:



Note The number of available RAID levels displayed depend on the specified number of hard disks.



Note Do not change any settings other than the RAID level.

- To change the RAID level, press **Enter**.
- To leave the RAID level as is, go to [Step 9](#).

- Step 8** Repeat [Step 4](#) through [Step 7](#), to continue configuring the RAID levels for each array.

- Step 9** Press **Enter** to complete the configuration using View/Add Configuration settings.
- Step 10** A **Save Configuration** message appears.
- Step 11** Press **Enter**.
- Step 12** The array configuration finishes and a message **Configuration Is Saved Press Any Key To Continue** appears.
- Step 13** Press any key to exit the LSI Software RAID Setup Utility.
-

