

Zenfone Max[®] M2

ZB633KL **User Guide**



Care and safety

Guidelines



Road safety comes first. We strongly recommend not to use your device when driving or operating any type of vehicle.



This device should only be used in environments with ambient temperatures between 0°C (32°F) and 35°C (95°F).



Turn off your device in restricted areas where the use of mobile devices is prohibited. Always obey rules and regulations when in restricted areas, such as, in aircraft, movie theater, in hospitals or near medical equipment, near gas or fuel, construction sites, blasting sites and other areas.



Use only AC adapters and cables approved by ASUS for use with this device. Refer to the rating label on the bottom of your device and ensure that your power adapter complies with this rating.



Do not use damaged power cables, accessories, and other peripherals with your device.



Keep your device dry. Do not use or expose your device near liquids, rain, or moisture.



You can put your device through x-ray machines (such as those used in conveyor belts for airport security), but do not expose the device to magnetic detectors and wands.



The device screen is made of glass. If the glass gets broken, stop using the device and do not touch the broken glass parts. Immediately send device for repair to ASUS-qualified service personnel.



Do not listen at high volume levels for long periods to prevent possible hearing damage.



Disconnect the AC power before cleaning your device. Use only a clean cellulose sponge or chamois cloth when cleaning your device screen.



Send device for repair to ASUS-qualified service personnel only.

Proper disposal



Risk of explosion if battery is replaced by an incorrect type. Dispose of used batteries according to the instructions.



DO NOT throw the battery in municipal waste. The symbol of the crossed out wheeled bin indicates that the battery should not be placed in municipal waste.



DO NOT throw this product in municipal waste. This product has been designed to enable proper reuse of parts and recycling. The symbol of the crossed out wheeled bin indicates that the product (electrical, electronic equipment and mercury-containing button cell battery) should not be placed in municipal waste. Check local regulations for disposal of electronic products.



DO NOT throw this product in fire. DO NOT short circuit the contacts. DO NOT disassemble this product.



WARNING

Cancer and Reproductive Harm-

www.P65Warnings.ca.gov

ZenTalk Fans Forum

http://www.asus.com/zentalk/global_forward.php



NOTE: For more legal and e-labelling information, check on your device from **Settings > System > About phone > Legal information**.

NOTE: The app descriptions shown in this manual are for reference purposes only, and may not exactly match what you see on your device.

Contents

1	Basics	
	Welcome!.....	7
	Get your ASUS Phone ready!.....	8
	Starting for the first time	14
	Using the touchscreen.....	15
2	There's no place like Home	
	Zen Home features	18
	Home screen	18
	Quick settings	19
	Notifications	20
	Personalizing your Home screen	21
	Widgets	21
	Wallpapers	22
	Setting up the date and time.....	23
	Setting up your ringtone and alert sounds.....	23
	Lock Screen	24
	Customizing your lock screen.....	24
	Fingerprint ID sensor.....	25
	Starting your ASUS phone for the first time	25
	Setting up fingerprint ID from Settings	26
	Face Unlock	27
	Setting up face unlock from Settings.....	27
3	Work hard, play harder	
	Chrome	30
	Launching Chrome	30
	Sharing pages.....	31
	Bookmarking pages	31
	Clearing the browsing data	31
	Gmail.....	32
	Google Calendar	33
	Creating events	33
	Editing or removing events	33
	Creating reminders	34
	Editing or removing reminders	34
4	Keeping in touch	
	Call in style	35
	Dual SIM feature.....	35
	Making calls.....	37
	Calling your favorite contacts	39
	Receiving calls	39
	Other call options.....	40
	Managing multiple calls.....	40

	Managing contacts	41
	Contacts Settings	41
	Setting up your profile	41
	Adding contacts.....	42
	Marking your favorite contacts	43
	Social networking with your contacts	44
	Send messages and more	45
	Messages	45
5	Fun and entertainment	
	Using a headset.....	46
	Connecting the audio jack.....	46
	Google Play Music	47
6	Your precious moments	
	Capture moments	48
	Launching the Camera app	48
	Using the Photos.....	49
	Viewing the photo location	49
	Sharing files from the Photos.....	49
	Deleting files from the Photos	50
	Editing images.....	50
7	Staying connected	
	Mobile network.....	51
	Enabling the mobile network	51
	Wi-Fi	51
	Enabling Wi-Fi	51
	Connecting to a Wi-Fi network.....	52
	Disabling Wi-Fi.....	52
	Bluetooth®	52
	Enabling Bluetooth®	52
	Pairing your ASUS Phone to a Bluetooth® device.....	53
	Unpairing your ASUS Phone from the Bluetooth® device	53
	Tethering	54
	Wi-Fi Hotspot	54
	Bluetooth Tethering.....	55
8	Travel and Maps	
	Clock	56
	Clock.....	56
	Alarm clock	57
	Stopwatch	57
	Timer	58

9	Zen Everywhere	
	Special Zen Tools.....	59
	Calculator	59
	Sound Recorder	60
10	Maintain your Zen	
	Keeping your device up-to-date.....	62
	Updating your system	62
	Storage	62
	Backup.....	62
	Reset.....	62
	Securing your ASUS Phone.....	63
	Appendix	
	Safety information.....	66
	Notices	68
	Index	

Welcome!

Explore the intuitive simplicity of ASUS ZenUI!

ASUS ZenUI is a charming and intuitive interface exclusively for ASUS Phones. It provides you with special apps, which are integrated in or with other apps, to fit your unique individual needs and make your life easier while letting you have fun with your ASUS Phone.



Camera

With PixelMaster technology, capture those precious moments in vivid and high-quality photos and videos.



Messages

Messages, an intuitive and delightful app, lets you send/receive SMS/MMS messages, as well as send group texts, photos, or audio messages. You can add emojis or stickers to your messages, share your location, archive your messages, and easily block SMS senders. You can also take photos or record videos and easily share these files.

NOTE: Availability of ASUS ZenUI apps vary per region and ASUS Phone model. Swipe up from the lower part of your Home screen to check the apps available on your ASUS Phone.

Get your ASUS Phone ready!

Parts and features

Take a hold of your device and have it running in a jiffy.

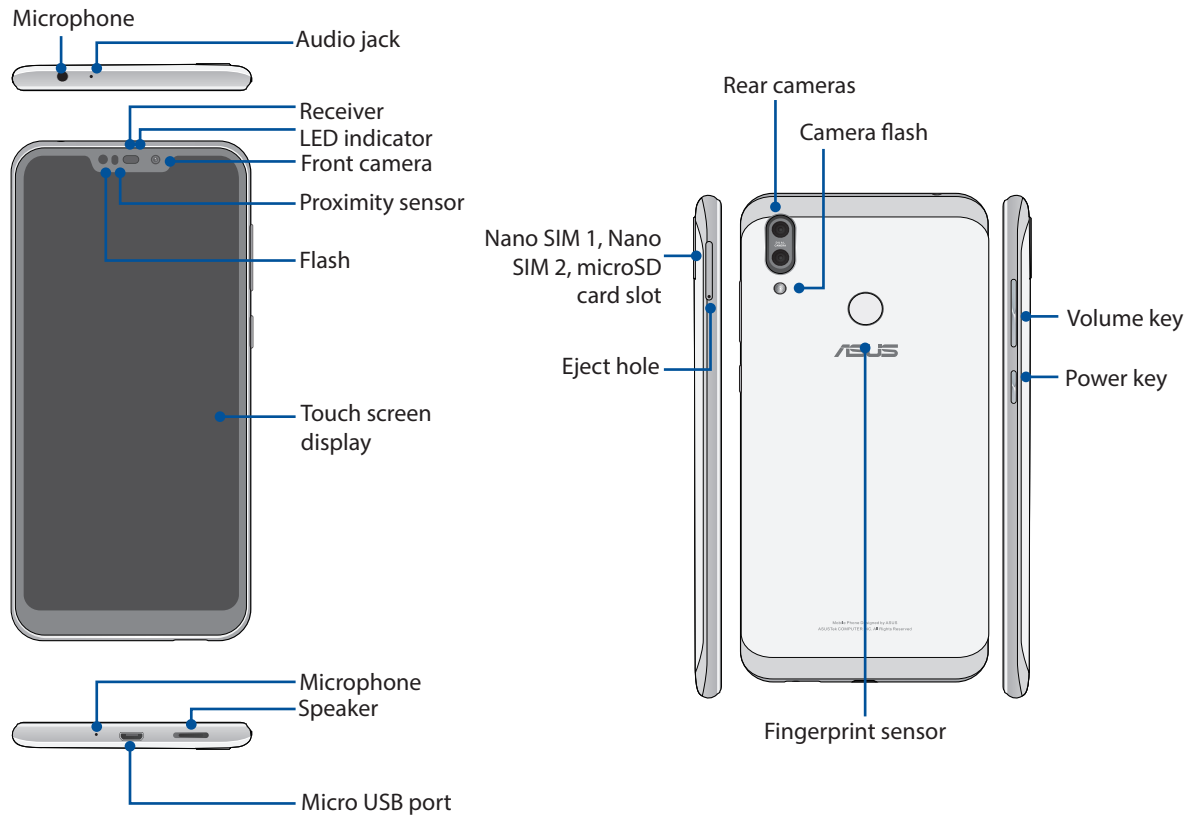

WARNING!

- To avoid network connection and battery issues:
 - DO NOT place a metallic sticker on the antenna area.
 - DO NOT use a metallic protective frame/case on your ASUS Phone.
 - DO NOT cover the antenna area with your hands or other objects while using some functions such as making calls or using the mobile data connection.
- We recommend that you use ASUS-compatible screen protectors. Using non-ASUS-compatible screen protectors may cause your ASUS Phone's sensor to malfunction.

NOTE: The microSD card slot supports microSD and microSDXC card formats.

IMPORTANT!

- We do not recommend using a screen protector as it can interfere with the proximity sensor. If you want to use a screen protector, ensure that it does not block the proximity sensor.
 - Keep the device, particularly the touch screen, dry all the time. Water or other liquids can cause the touch screen to malfunction.
-

Installing a nano SIM card / memory card

Both nano SIM card slots support GSM/GPRS/ EDGE, WCDMA/HSPA+/DC-HSPA+, FDD-LTE, and TD-LTE DSDV network bands.

NOTE: To prevent connector damage, ensure to use a standard nano SIM card without a SIM adapter or the use of a cutter.

Your ASUS Phone supports a microSD and microSDXC memory card with up to 2 TB capacity.

NOTES:

- Some memory cards may not be compatible with your ASUS Phone. Ensure that you use only compatible memory cards to prevent loss of data, damage to your device, or memory card, or both.
 - The microSD card is sold separately.
-

CAUTION! Be extra careful when handling a nano SIM card / memory card. ASUS is not responsible for any data loss or damage incurred to your nano SIM cards / memory card.

To install a Nano SIM card / memory card:

1. Push the bundled eject pin into the hole on the card slot to eject the tray out.

CAUTION!

- Be careful not to damage the card slot cover or injure your fingernails when you remove the cover.
 - Do not forcibly remove, shear, or distort the card slot cover.
 - Do not use sharp tools or solvent on your device to avoid scratches on it.
-

2. Insert the Nano SIM or microSD card into the appropriate slot.

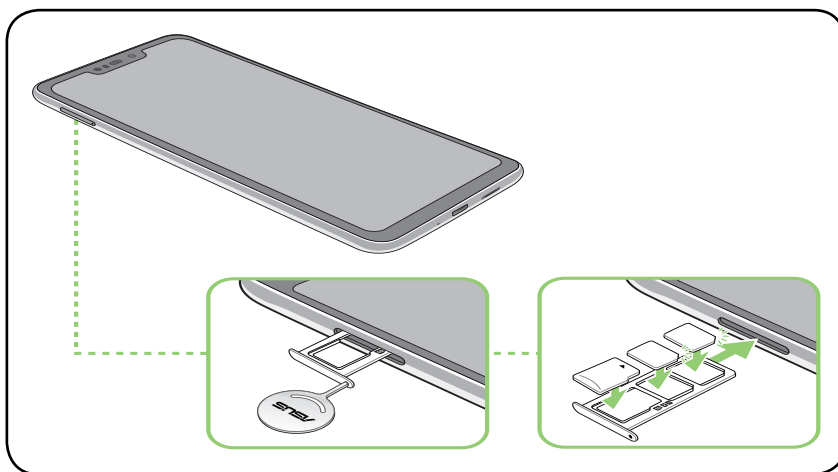



3. Gently push the tray back in until it's securely closed.

IMPORTANT!

- Both Nano SIM card slots support GSM/GPRS/ EDGE, WCDMA/HSPA+/DC-HSPA+, FDD-LTE, and TD-LTE DSDV network bands. Both Nano SIM cards can connect to VoLTE 4G calling service. But only one can connect to FDD-LTE, and TD-LTE data service at a time.
 - ASUS phone 2G/3G/4G/LTE band compatibility varies by region. Check compatibility with your local carriers.
-

Removing a nano SIM /memory card

CAUTION!

- Be extra careful when handling a nano SIM card / memory card. ASUS is not responsible for any data loss or damage incurred to your nano SIM cards / memory card.
 - Eject the memory card properly to safely remove it from device. To eject the memory card, swipe down from the top of your screen and tap  > **Storage**, then under Portable storage, tap  beside **SD card**.
-

To remove a nano SIM card / memory card:

1. Push the bundled eject pin into the hole on the card slot to eject the tray out.
-

CAUTION!

- Be careful not to damage the card slot cover or injure your fingernails when you remove the cover.
 - Do not forcibly remove, shear, or distort the card slot cover.
 - Do not use sharp tools or solvent on your device to avoid scratches on it.
-

2. Remove the nano SIM or microSD card from the card slot.

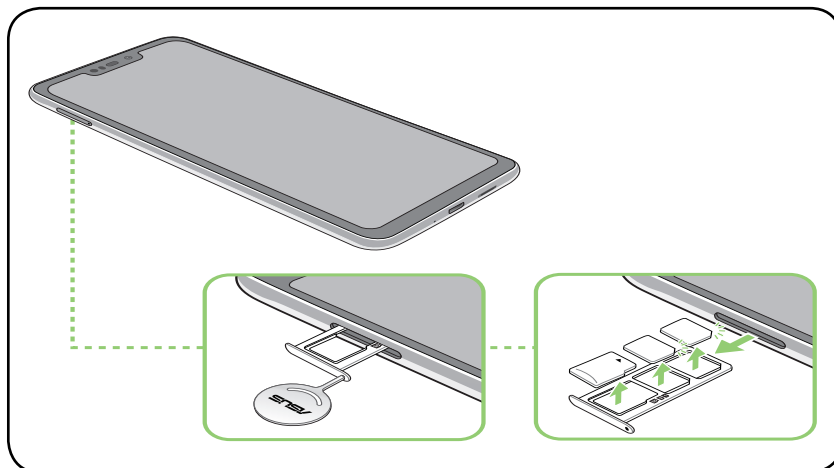

3. Gently push the tray back in until it's securely closed.

Charging your ASUS Phone

Your ASUS Phone comes partially charged but you must charge it fully before using it for the first time. Read the following important notices and cautions before charging your device.

IMPORTANT!

- Peel off the protective film on the AC power adapter and Micro USB cable before using it with your device.
- Ensure to plug the AC power adapter to a compatible power outlet. You can plug the AC power adapter to any compatible 100~240 V outlet.
- The output voltage of the AC power adapter for this device is +5V $\overline{=}$ 2A, 10W.
- When using your ASUS Phone while plugged-in to a power outlet, the power outlet must be near your device and easily accessible.
- To conserve electricity, unplug the AC power adapter from the power outlet when not in use.
- Do not place heavy objects on top of your ASUS Phone.

CAUTION!

- While charging, your ASUS Phone can become warm. This is normal, however, if your device becomes unusually hot, disconnect the micro USB cable from your device and send the device, including the AC power adapter and cable to an ASUS-qualified service personnel.
 - To prevent any damage to your ASUS Phone, AC adapter, or micro USB cable. Ensure that the micro USB cable, AC adapter, and your device are connected properly before charging.
-

To charge your ASUS Phone:

1. Connect the micro USB cable to the power adapter.
2. Connect the micro USB cable to your ASUS Phone.
3. Plug the AC power adapter to a grounded power outlet.

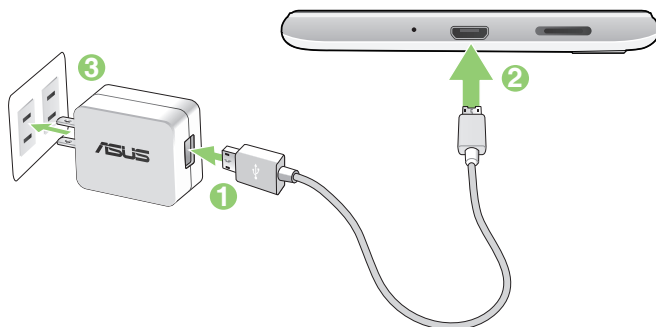

IMPORTANT!

- When using your ASUS Phone while it is plugged to a power outlet, the grounded power outlet must be near to the unit and easily accessible.
- When charging your ASUS Phone through your computer, ensure that you plug the micro USB cable to your computer's USB port.
- Avoid charging your ASUS Phone in an environment with ambient temperature of above 35°C (95°F).
- Charge your ASUS Phone for eight (8) hours before using it in battery mode for the first time.
- The status of battery charge is indicated by the following icons:

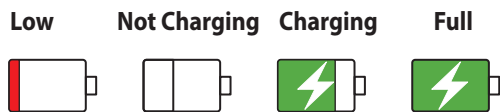

NOTES:

- For safety purposes, use **ONLY** the bundled power adapter and cable to avoid damaging your device and prevent the risk of injury.
 - For safety purposes, use **ONLY** the bundled power adapter and cable to charge your ASUS Phone.
 - The input voltage range between the wall outlet and this adapter is AC 100V - 240V. The output voltage of the device is +5V=2A, 10W.
-

4. When fully-charged, disconnect the USB cable from your ASUS Phone first before unplugging the AC power adapter from the power outlet.

NOTES:

- You can use your device while charging but it may take longer to fully charge the device.
 - Charging your device via USB port of a computer may take longer to fully charge the device.
 - If your computer does not provide enough power for charging via USB port, charge your ASUS Phone using the AC power adapter plugged to a power outlet instead.
-

Turning your ASUS Phone on or off

Turning your device on

To turn your device on, press and hold the power button until your device vibrates and starts up.

Turning your device off

To turn your device off:

1. If your screen is turned off, press the power button to turn it on. If your screen is locked, unlock the device screen.
2. Press and hold the power button, then when prompted, tap **Power off**.

Sleep mode

To put your device in sleep mode, press the power button once until the screen turns off.

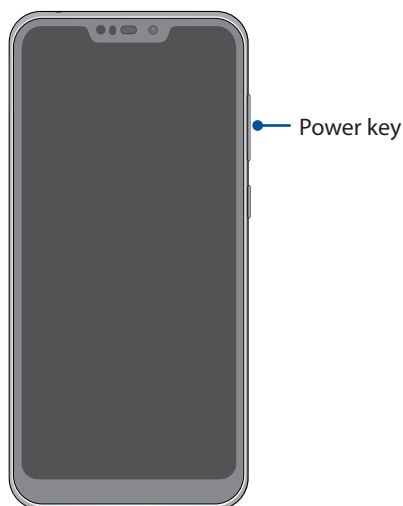

Starting for the first time

When you turn your ASUS Phone on for the first time, Setup Wizard will guide you through the setup process. Follow the onscreen instructions to select your language, set up your mobile network, Wi-Fi and security features, and sync accounts.

Use your Google or ASUS account to set up your device, if you do not have a Google or ASUS account yet, go ahead and create one.

Google Account

Using a Google Account allows you to fully utilize these Android OS features:

- Organize and see all your information from anywhere.
- Automatically backup all your data.
- Leverage Google services conveniently from anywhere.

ASUS Account

Having an ASUS Account gets you to enjoy the following perks:

- Personalized ASUS support service and warranty extension for registered products.
- Receive the latest device and firmware updates.

Battery power conservation tips

The battery charge is the lifeline of your ASUS Phone. Here are some battery power conservation tips that help preserve the power of your ASUS Phone battery.

- Close all running apps that are not in use.
- When not in use, press the power button to put the device in sleep mode.
- Decrease brightness of display.
- Keep the speaker volume to a low level.
- Disable Wi-Fi feature.
- Disable Bluetooth feature.
- Disable the screen auto-rotate feature.
- Disable all auto-sync features in your device.

Using the touchscreen

Use these gestures on the touchscreen to launch apps, access some settings, and navigate your ASUS Phone.

Launching apps

To launch an app, simply tap on it.

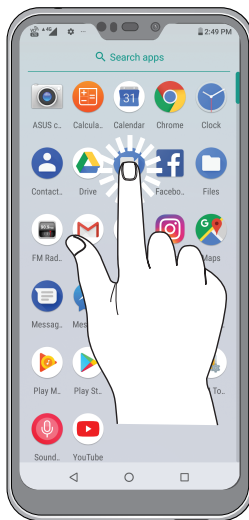

Moving or deleting items

Do any of the following:

- To move an app or widget, tap and hold then drag it to the location where you want it to be.
- To delete an app or widget from the Home screen, tap and hold it then tap  .



Moving through pages or screens

Do any of the following:

- Swipe your finger to the left or to the right to switch between screens or to open Google Search page.
- Scroll your finger up or down to go through web pages or list of items.

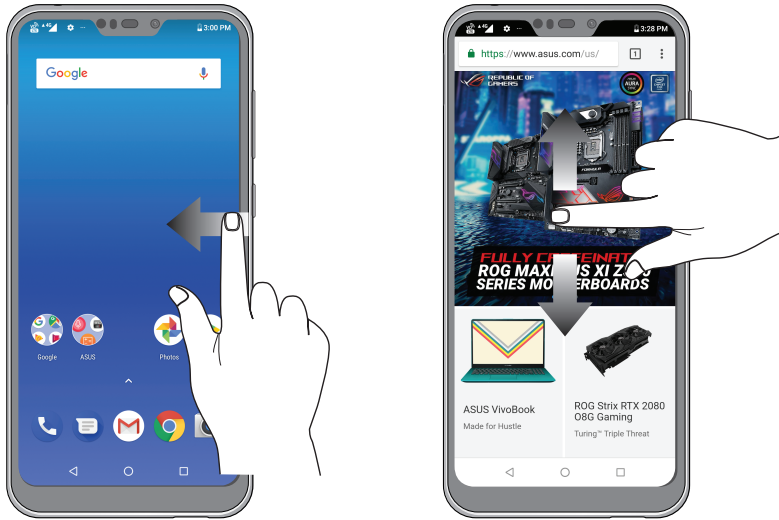

Zooming in

Spread apart your two fingers on the touch panel to zoom in an image in Photos or Maps, or zoom in a web page.

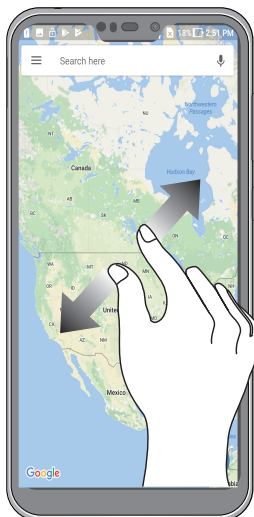

Zooming out

Bring together your two fingers on the touch panel to zoom out an image in Photos or Maps, or zoom out of a web page.



NOTE: You may not be able to zoom in/out of some web pages as these pages may have been designed specifically to fit your mobile screen.

There's no place like Home

2

Zen Home features

Home screen

Get reminders of important events, app and system updates, weather forecasts, and text messages from people who really matter to you, right from your Home screen.

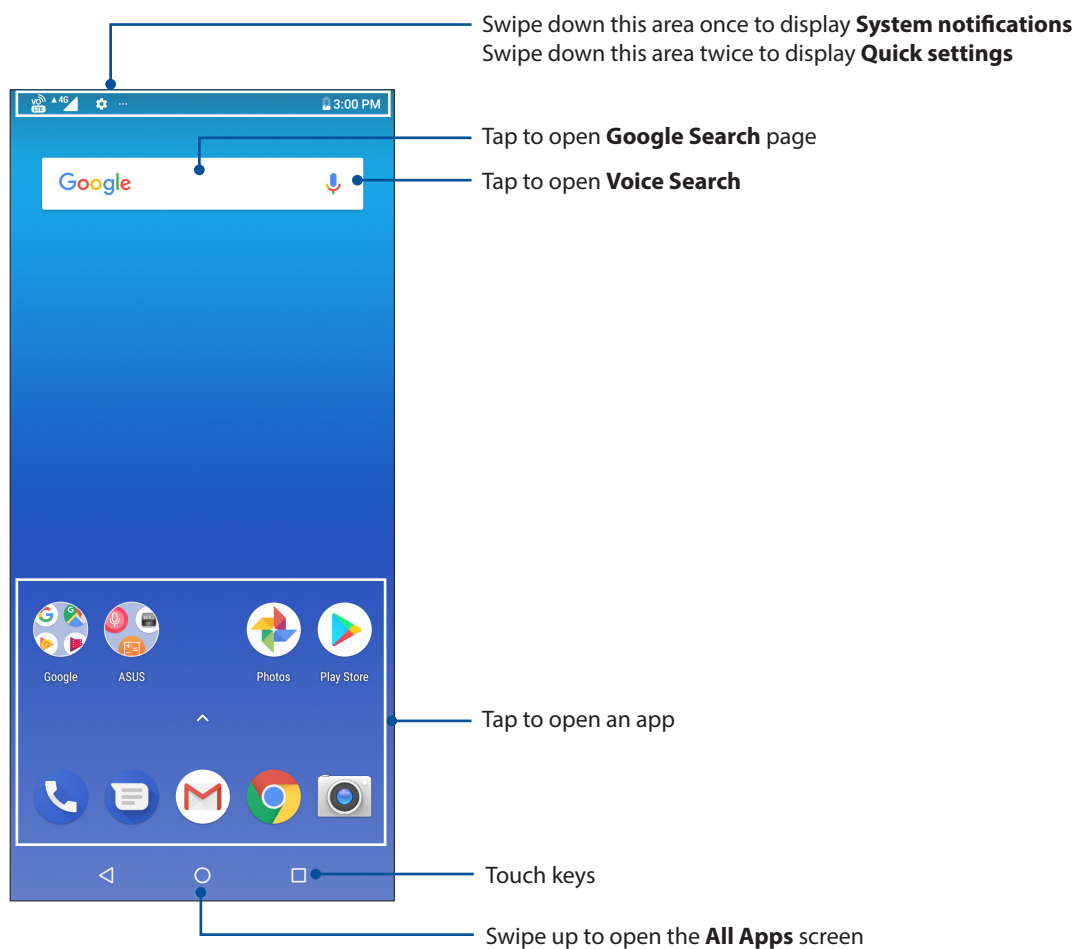

Quick settings

The Quick settings panel provides a one-tap access to some of the wireless features and settings of your ASUS Phone. Each of these features are represented by an icon.

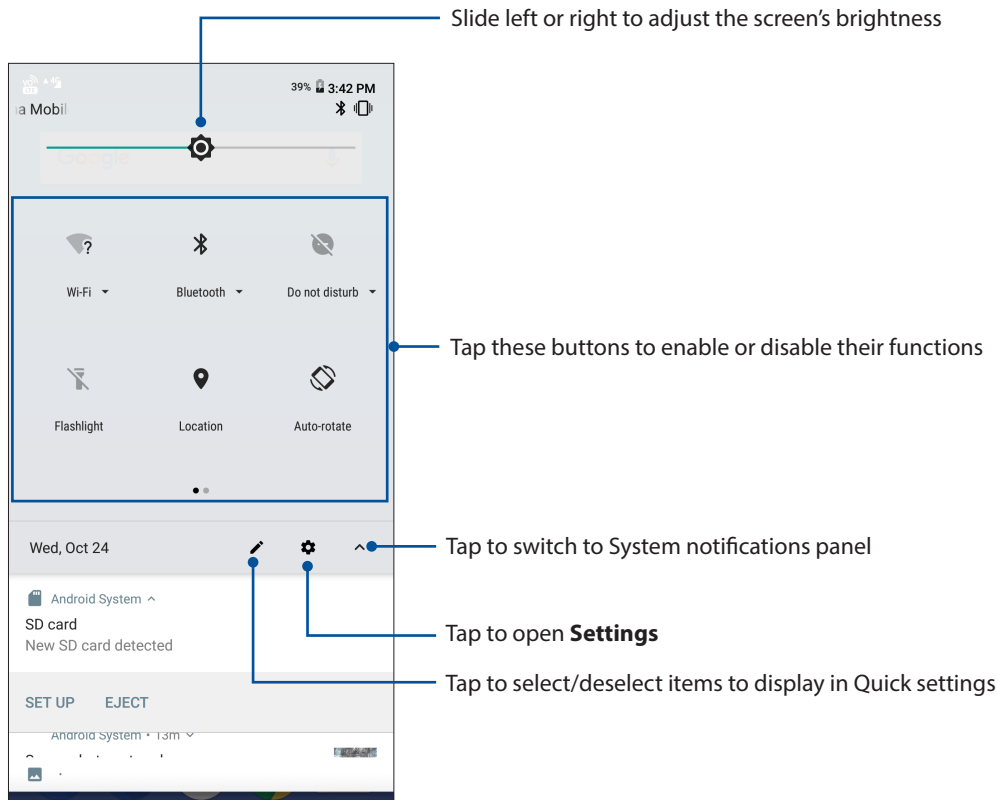

To launch the Quick settings panel, swipe down twice from the top of your screen.

NOTE: A black icon indicates that the feature is currently enabled while a gray icon indicates a disabled feature.



Adding features

To add features from the Quick Settings panel:

1. Launch Quick settings then tap .
2. Swipe up **Drag to add tiles**.
3. Under **Drag to add tiles**, tap and drag an icon up to add it to the Quick Settings panel.
4. Tap  to go back and view the current Quick Settings panel.

Removing features

To remove existing features from the Quick Settings panel:

1. Launch Quick settings then tap .
2. Tap and drag an icon below **Drag to add tiles** to remove it from the Quick Settings panel.

Notifications

From the notifications panel, you can see the latest updates done and system changes made on your ASUS Phone. Most of these changes are data and system-related.

To launch the notifications panel, swipe down from the top of your screen.

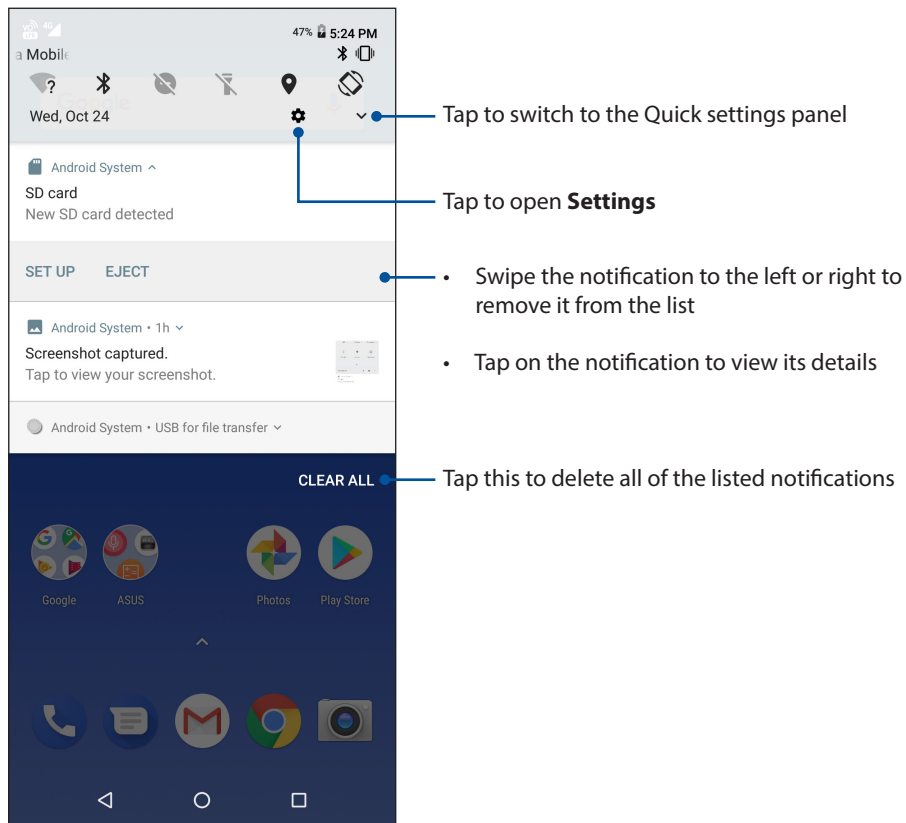

Personalizing your Home screen

Stamp your own personality on your Home screen. Select an attractive design as your wallpaper, and add widgets for a quick review of important info. You can also add more pages so you can add and quickly access or view more apps or widgets on your Home screen.

To launch the Manage Home screen, tap and hold an empty area on your Home screen.

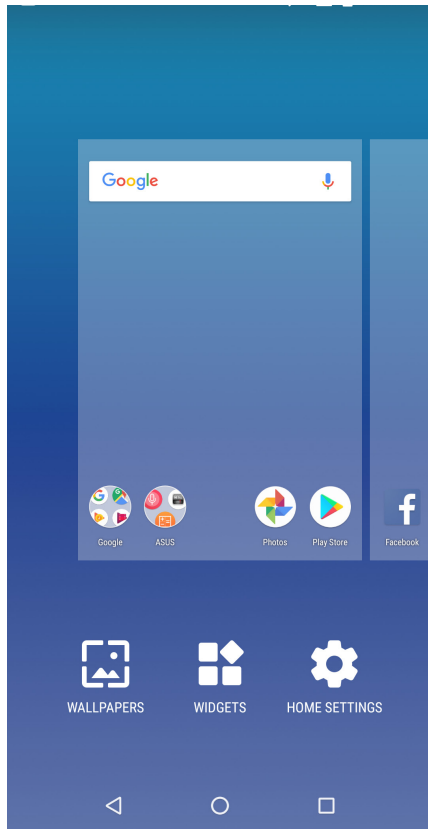

Widgets

You can put widgets, which are small dynamic apps, on your Home screen. Widgets provide you with quick-views of the weather forecast, calendar events information, battery status, and more.

Adding widgets

To add a widget:

1. Tap and hold an empty area on your Home screen and select **WIDGETS**.
2. From the Widgets screen, tap and hold a widget, then drag it to an empty area on your Home screen.

Removing widgets

From your Home screen, tap and hold a widget, then drag it to **Remove** on top of your screen.

Wallpapers

Let your apps, icons, and other Zen elements sit on an attractively designed wallpaper. You may add a translucent background tint to your wallpaper for readability and clarity. You can also select an animated wallpaper to make your screen come alive.

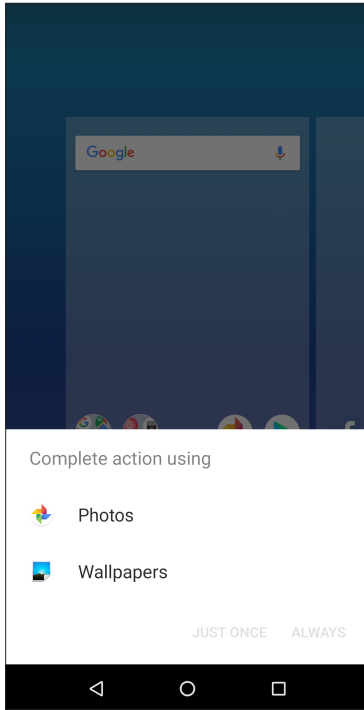

Applying wallpaper

To apply wallpaper:

1. Tap and hold an empty area on your Home screen and select **WALLPAPERS**.
2. Select a wallpaper from **Photos** or **Wallpapers**.
3. Tap **Set wallpaper**.

NOTE: You can also set up your wallpaper settings from **Settings > Display > Wallpaper**.

Setting up the date and time

By default, the date and time displayed on your Home screen automatically syncs with your mobile provider's settings.

To change the date and time settings:

1. Launch the Settings screen by doing any of the following:
 - Launch Quick Settings then tap .
 - Swipe up from the lower part of your Home screen then tap **Settings**.
2. Scroll down the Settings screen and select **System > Date & time**.
3. Slide **Automatic date & time** and **Automatic time zone** to **OFF**.
4. Adjust the date and time.
5. Select the time zone.
6. You can opt to use the 24-hour format, if you prefer.

NOTE: See also [Clock](#).

Setting up your ringtone and alert sounds

Set up the sound for your phone ringtone, notifications such as text messages, emails, and event alerts. You can also choose to enable or disable the dial pad touch tones, touch sounds, screen lock sound, or you can choose to have your ASUS Phone vibrate when you tap on it.

To set up the sound settings:

1. Launch the Settings screen by doing any of the following:
 - Launch Quick Settings then tap .
 - Swipe up from the lower part of your Home screen then tap **Settings**.
2. Select **Sound** and set up your preferred sound settings.

Lock Screen

By default, the lock screen appears after turning on your device and while waking it up from sleep mode. From the lock screen, you can proceed to your device's Android® system by swiping on your touch screen panel.

Your device's lock screen can also be customized to regulate access to your mobile data and apps.

Customizing your lock screen

If you want to change your lock screen settings from the default **Swipe** option, refer to the following steps:

1. Launch Quick Settings then tap .
2. Select **Security & location**.

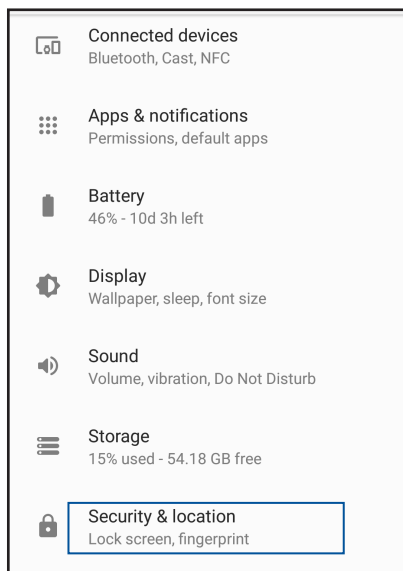

3. In the next screen, tap **Screen lock**.

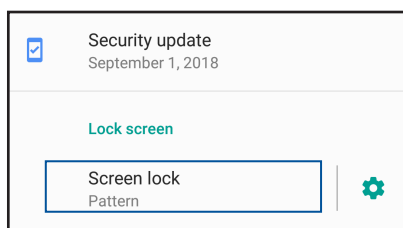

4. Tap the screen lock option you would like to use.

NOTE: For more details, see [Securing your ASUS Phone](#).

Fingerprint ID sensor

Fingerprint ID sensor prevents others from using your ASUS phone without your permission. You can use your fingerprint to unlock your device, access your phone calls and data. When you set up your fingerprint ID, you also need to set up your screen lock method for device startup.

Starting your ASUS phone for the first time

To set up your fingerprint ID when using your ASUS Phone for the first time:

1. Ensure that the fingerprint identification module and your finger are clean and dry.
2. From the Welcome page, follow the on-screen instructions to the **Protect your phone** page and tap **Set up fingerprint**.
3. Tap **Next** to choose a screen lock method, and then follow the instructions to the **Touch the sensor** page.
4. Find the fingerprint scanner at the back of your device, adjust your finger and try to cover different areas of your finger repeatedly until your fingerprint is captured.

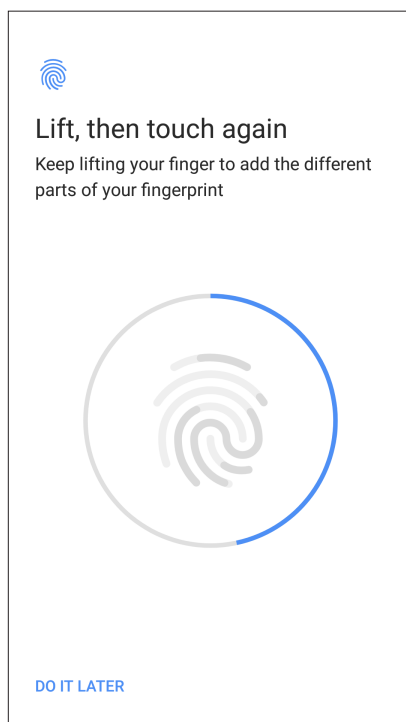

5. Tap **DONE** to complete the setup.

Setting up fingerprint ID from Settings

To set up your fingerprint ID from **Settings**:

1. Ensure that the fingerprint scanner and your finger are clean and dry.
2. Launch the Settings screen by doing any of the following:
 - Launch Quick Settings then tap .
 - Swipe up from the lower part of your Home screen then tap **Settings**.
3. Scroll down the **Settings** screen and select **Security & location > Fingerprint**.

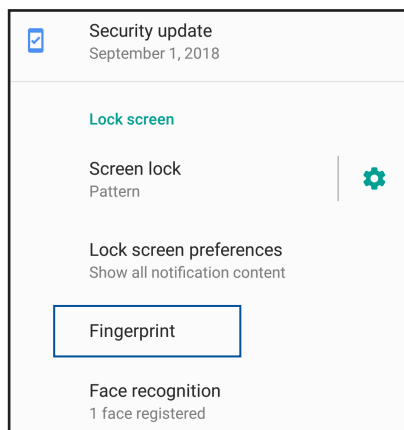

4. Unlock your phone if it's secured. If not, follow the instructions to set up your backup screen lock method.

NOTE: For more details, see [Securing your ASUS Phone](#).

5. Tap **Add fingerprint**.

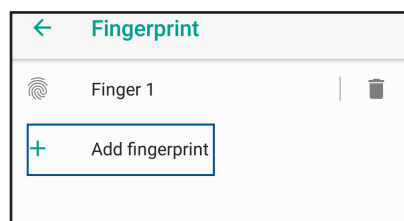

6. Repeatedly place-and-lift your finger on the scanner until your fingerprint is captured.
7. Tap **DONE** to complete the setup.

Face Unlock

Face unlock prevents others from using your ASUS phone without your permission effortlessly. You can light up your ASUS Phone's screen and look at it to unlock your device, access your phone's home screen in one second. When you set up your face unlock, you also need to set up your screen lock method for device startup.

Setting up face unlock from Settings

To set up face unlock from **Settings**:

1. Launch the Settings screen by doing any of the following:
 - Launch Quick settings then tap .
 - Swipe up from the lower part of your Home screen and tap **Settings**.
2. Scroll down the Settings screen and select **Security & location** > **Face recognition**.

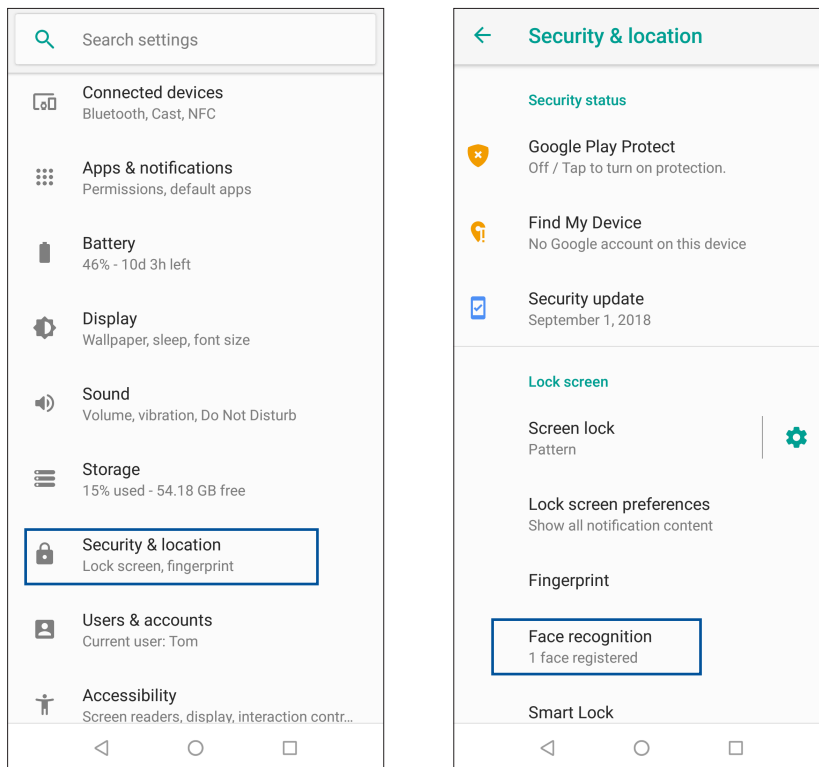

3. Tap **CONTINUE**.
4. Follow the instructions to set up your backup screen lock method.

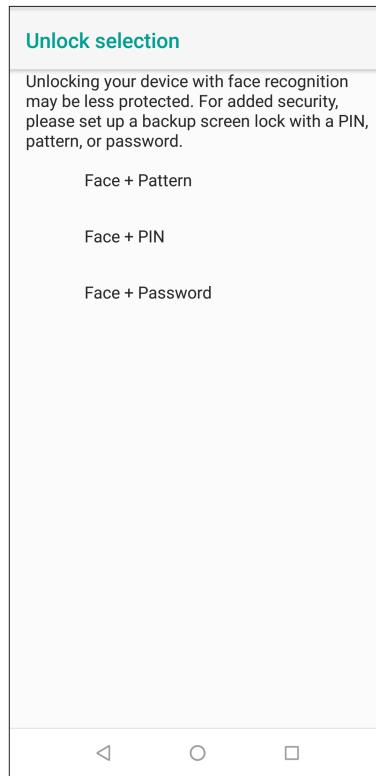
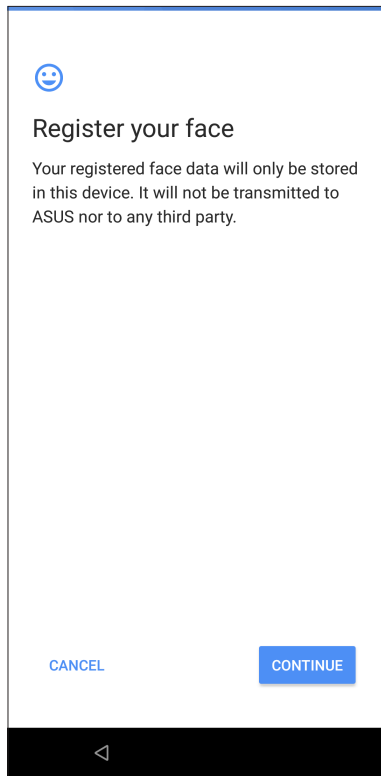

5. Select how you want to display your notifications on the lock screen, then tap **DONE**.

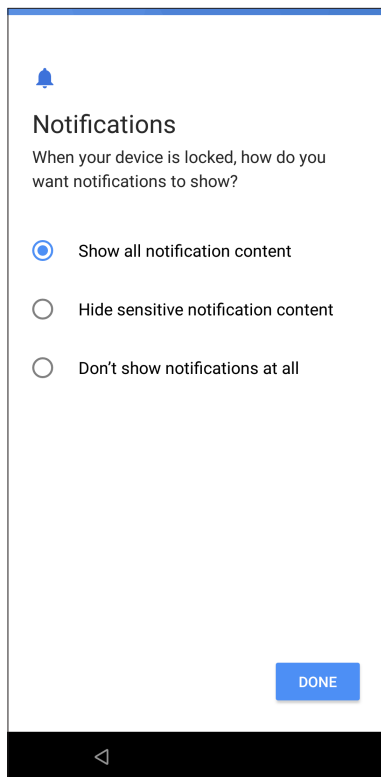

6. Tap **Next** and follow the instructions to register your face.

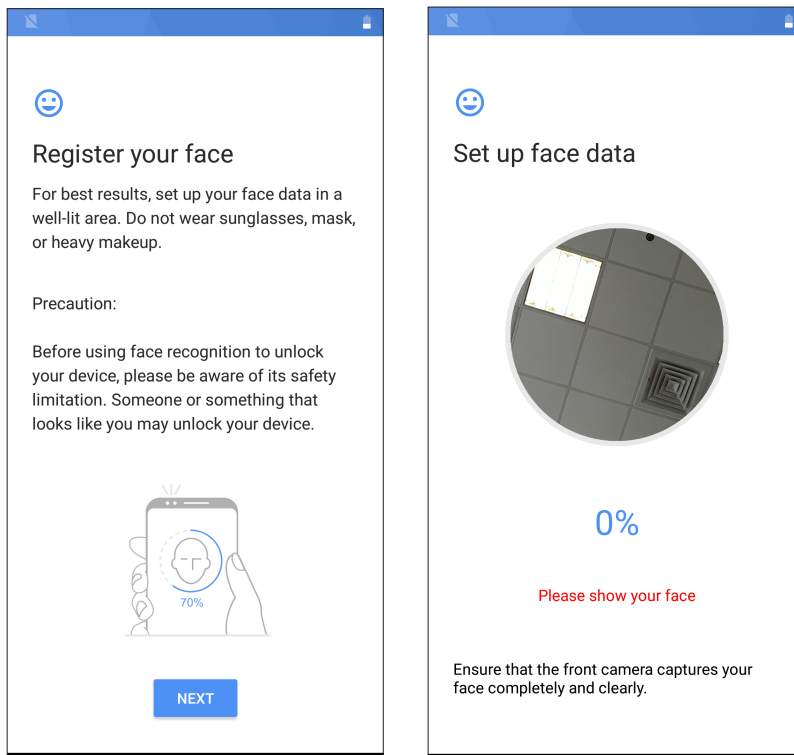

7. When finished, tap **TURN ON** to enable face recognition to unlock your phone.

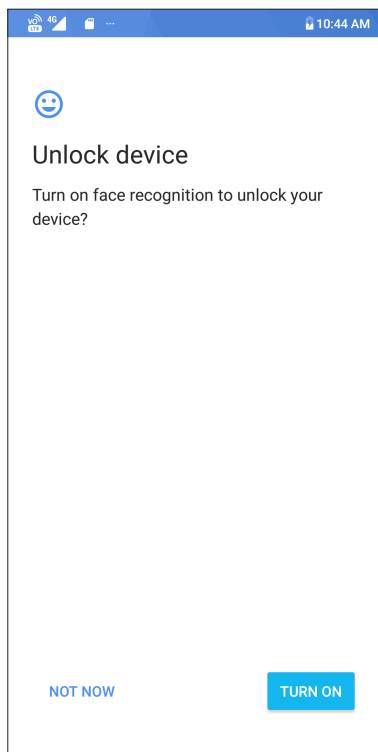

NOTES:

- Show your mouth, nose and opened eyes while using face unlock feature.
- Wearing sunglasses or insufficient light will lead to failure of face unlock.

Work hard, play harder

3

Chrome

Chrome for Android lets you enjoy the same fast, secure and stable web browsing experience as that on the desktop Chrome. Sign in to your Google account to sync tabs, bookmarks, and browsing history across all your devices. If you don't have a [Google account](#), register for one.

NOTE: For details on creating a Google account, see [Gmail](#).

IMPORTANT! Before doing any Internet surfing or Internet-related activities, ensure that your ASUS Phone is connected to a Wi-Fi or mobile network. For more details, see [Staying connected](#).

Launching Chrome

From your Home screen, do any of the following to launch Chrome:

- Tap .
- Swipe up from the lower part of your Home screen then tap **Google > Chrome**.

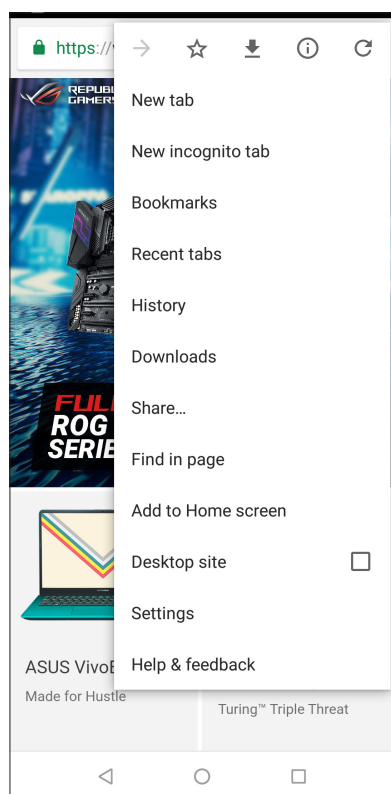

Sharing pages



Share interesting pages from your ASUS Phone to others via an email account, cloud storage account, Bluetooth, or other ASUS Phone apps.

1. Launch Chrome.
2. From a web page, tap  > **Share...**
3. Tap the account or app that you want to use as medium in sharing the page.

Bookmarking pages

Bookmark your favorite pages or websites so you can go back and browse them again.

To bookmark a page:

From the page, tap  >  . To view your favorite pages, tap  > **Bookmarks**, then select the page you want to view or access.

Clearing the browsing data

Clear the browsing data that are temporarily stored in your ASUS Phone to improve the loading performance of your Chrome browser. The browsing data includes browsing history, cache, cookies/site data, saved passwords, and autofill data.

1. Launch the browser.
2. Tap  > **Settings** > **Privacy** > **Clear browsing data**.
3. Select the browsing data that you want to delete.
4. When done, tap **CLEAR DATA**.

Gmail

Use Gmail to set up your Google account to get into Google-related services and apps as well as receive, send, and browse emails right from your ASUS Phone. You can also set up other email accounts such as Yahoo or your work email account via Gmail.

IMPORTANT! Your ASUS Phone must be connected to a Wi-Fi or mobile network so you can add an email account or send and receive emails from added accounts. For more details, see [Staying connected](#).

To set up your Google account:

1. From your Home screen, tap .
2. Tap **Add an email address**.
3. Select **Google**.
4. Enter your email address. To create a new Google account, tap **More options > Create account**.
5. Follow the next steps to sign in to your Google account.

NOTE: If you want to set up your work account on your ASUS Phone, ask for the email settings from your network administrator.

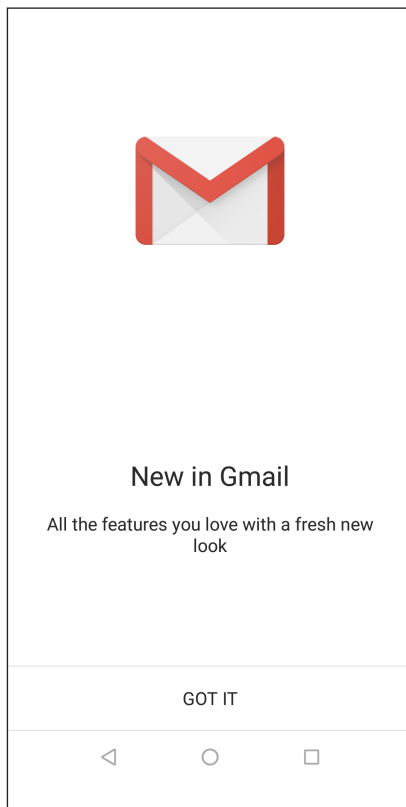





Google Calendar

Bring your schedule to life and keep track of all your important events or reminders. Events that you create or edit will automatically sync with all Google Calendar versions that you've logged into.



Creating events

To create an event:

1. From the Home screen, tap **Google > Calendar**.
2. Tap  then tap **Event**.
3. Enter your event name, and select the date and time for the event. You may set the event as an all-day or recurring event.
 - All-day event: From the **All-day** field, move the slider to the right.
 - Recurring event: Tap **More options** > , then select how often you want the event to recur or repeat.
4. To set the time zone, tap **More options** > , then enter the country whose time zone you want displayed.
5. From the **Add location** field, enter the venue or location of the event.
6. Tap , then you may select or set the time or day to get a notification or reminder about the event.
7. From the **Invite people** field, enter the email addresses of your guests to the event.
8. You may also add note or attachment from the **Add note** or **Add attachment** field.
9. Once finished, tap **SAVE**.



Editing or removing events

To edit or remove an event:

1. From the Home screen, tap **Google > Calendar**.
2. Tap the event that you want to edit or delete.
3. To edit the event, tap  and make the necessary changes. To remove the event, tap  > **Delete**, then tap **DELETE** to confirm the deletion.



Creating reminders

To create a reminder:

1. From the Home screen, **Google > Calendar**.
2. Tap  then tap **Reminder**.
3. Enter your reminder name and tap **DONE**.
4. Set the date and time for the reminder. You may set the reminder as an all-day or recurring reminder.
 - All-day reminder: From the **All day** field, move the slider to the right.
 - Recurring reminder: Tap , then select how often you want the reminder to recur or repeat.
5. Once finished, tap **SAVE**.

Editing or removing reminders

To edit or remove a reminder:

1. Tap **Google > Calendar**.
2. Tap the reminder that you want to edit or delete.
3. To edit the reminder, tap  and make the necessary changes. To remove the reminder, tap  > **Delete**, then tap **DELETE** to confirm the deletion.

Keeping in touch

4

Call in style

Dual SIM feature

The dual SIM feature of your ASUS Phone lets you manage the settings of the installed Nano SIM cards. With this feature, you can enable/disable Nano SIM cards, assign SIM names, or set one as a preferred network.

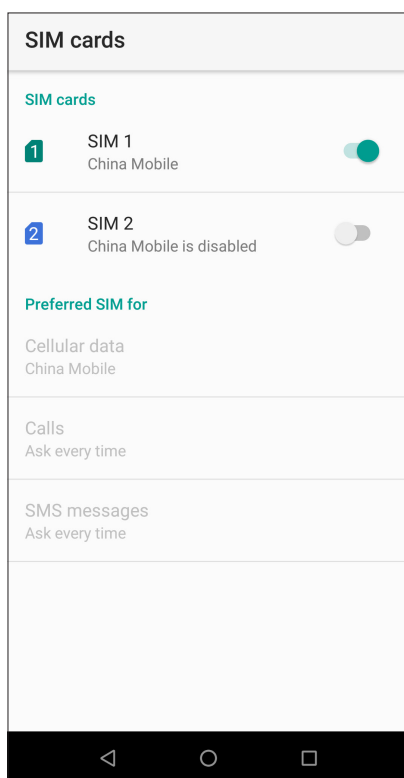

Renaming your Nano SIM cards

Change the names of your Nano SIM cards on your ASUS Phone so that you can identify them easily.

To change the names of your Nano SIM cards, tap **SIM 1 name: SIM 1** or **SIM 2 name: SIM 2** then key in the names for your Nano SIM cards.

NOTE: If your SIMs have different mobile service providers, we recommend you to use the names of these providers for your SIM names. If both SIMs have the same mobile service provider, we recommend you to use the mobile numbers for your SIM names.

Assigning a preferred SIM card

Assign a SIM card as your preferred SIM for voice calls, SMS messages, and data services.

SIM card for calls

When you make a call, your ASUS Phone automatically uses the preferred SIM card to connect the call.

To assign a SIM card for voice calls, tap **Calls** then tap the SIM that you want to use.

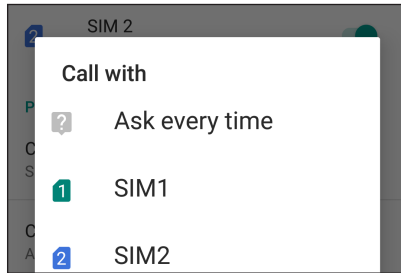

IMPORTANT! You can only use this feature if you make a call from your contacts list.

SIM card for SMS messages

To assign a SIM card for SMS messages, tap **SMS messages** then select from **SIM 1** or **SIM 2**.

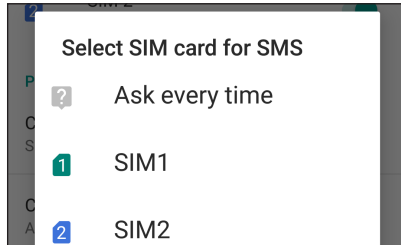

SIM card for Cellular data

To assign a SIM card for data service, tap **Cellular data** then select from **SIM 1** or **SIM 2**.

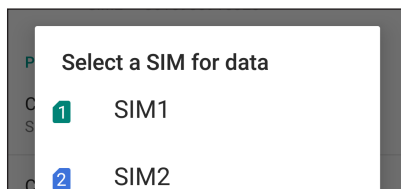

Making calls

Your ASUS Phone offers you many ways to make a call. Call your friends from your contacts list, smart dial to quickly place a call, or enter a speed-dial number to call your frequently-called contact.

NOTE: Organize your contacts in the Contacts app. For details, see [Managing contacts](#).

Launching the Phone app

From your Home screen, do any of the following to launch the Phone app:

- Tap .
- Swipe up from the lower part of your Home screen then tap **Phone**.

Dialing a phone number

Use the Phone app to directly dial a phone number.

1. From your Home screen, tap  then tap the number keys.
2. Select from call buttons **SIM 1** or **SIM 2** to dial the number.



NOTE: The labels of the call buttons may vary depending on the setting that you made to your SIM cards. For more details, see [Dual SIM feature](#).

Dialing an extension number

When you need to call an extension number, you can do any of these steps to skip the voice prompts.



Prompting for confirmation of an extension number

You can insert a confirmation prompt for the extension number after dialing the main number.

1. From the Phone app, enter the main number.
2. To insert a confirmation prompt, tap  > **Add wait** then a semi-colon (;) appears.
3. Enter the extension number.
4. Select from call buttons **SIM 1** or **SIM 2** to make the call.
5. When prompted, tap **Yes** to confirm the extension number.
6. Tap  to end the call.

Auto-dialing an extension number

You can insert a short or long pause after dialing the main number, then the extension number is dialed automatically.

1. From the Phone app, enter the main number.
2. To insert a pause, tap  > **Add 2-sec pause** then a comma (,) appears.
3. Enter the extension number.
4. Select from call buttons **SIM 1** or **SIM 2** to place the call.
5. Tap  to end the call.

Smart dialing your contacts

As you enter the first few numbers or letters of your contact's name, Smart Dial filters through your contacts list or call logs and provides you with possible matches. You can check if the contact you're trying to reach is on the list of possible matches, then you can quickly place that call.

1. Launch the Phone app then enter the number or name of the contact in the Search field.
2. From the list of possible matches, tap the contact you wish to call. If the contact is not on list, enter the complete number or name of the contact.
3. Select from call buttons **SIM 1** or **SIM 2** to make the call.

NOTE: The labels of the call buttons may vary depending on the setting that you made to your SIM cards. For more details, see also [Dual SIM feature](#).

Calling from Contacts app

Use the Contacts app to make a call from your contacts list.

1. Launch the Contacts app.
2. Tap the contact name then tap the number that you wish to dial.
3. If there are two SIM cards installed, tap the SIM card from which you want to make the call.
4. Tap  to end the call.

NOTE: To view all contacts from all contact accounts, tap **Contacts to display** dropdown list then tick all accounts.

Calling your favorite contacts

When you add a contact to your Favorites list, you can quickly call the contact from the Phone app.

1. Launch the Phone app.
2. Tap **Favorites** to display your Favorites list, then tap your favorite contact whom you want to call.
3. Tap  to end the call.

Receiving calls

The touch screen of your ASUS Phone lights up when there is an incoming call. The display of the incoming call also varies, depending on the status of your ASUS Phone.

Answering calls

There are two ways to answer a call depending on the status of your ASUS Phone:

- If your device is active, tap **ANSWER** or to reject a call, tap **DECLINE**.
- If your device is locked, swipe  up to answer or down to reject the call.

Managing your call logs

From your call logs, you can call back your missed calls, save calls to your contacts list, or redial your recently-called number or contact.

Saving calls to Contacts



You can add a call/number from your call logs to your contacts list.

1. From the Phone app, tap **Recents** to display your call logs.
2. Tap the number that you want to add to your contacts list.
3. Tap **Create new contact** to add a new entry to your contacts list.

Tap **Add to a contact**, select a contact, choose whether to overwrite the contact's number with this new one or add a new entry, then tap **SAVE**.

Redialing your last-called number

To redial your last-called number:

1. From the Phone app, tap **Recents** to display your call logs.
2. Tap  beside your last-called number to redial the number.
3. Tap  to end the call.

Other call options

During an active call, tap any of the possible call options for when a call is in progress.



Microphone

Turns the microphone for the active call on or off. When the microphone is off or in mute mode, you can hear the caller but the caller can't hear you.



Speakerphone

Turns the speakerphone on or off.



Call on hold

Puts an active call on hold.



Conference call

When you have subscribed to a conference call service with your mobile service provider, this icon allows you to add a contact or contacts in an active call.

NOTES:

- The number of participants in the conference call depend on your conference call subscription. You can inquire from your mobile service provider about this service.
- For more details on conference call, see [Managing multiple calls](#).

Managing multiple calls

Your ASUS Phone provides you the convenience of making or taking two calls.

Answering another call

While you are talking on your ASUS Phone, you can hear a beeping sound, indicating of another incoming call. Tap **Answer** on the touch screen to receive an incoming call while on an active call.

Managing contacts

Organize your contacts and easily stay in touch with them via calls, SMS messages, emails, or social networks. Group your contacts as Favorites to quickly get in touch with them, or group them as VIPs to get notified about any upcoming events, missed calls, or unread messages.

You can also sync your contacts with your email or social network accounts, link contacts' info for easy access in one place, or filter the contacts you want to keep in touch with.

To launch the Contacts app, swipe up from the lower part of your Home screen then tap **Contacts**.

Contacts Settings

Select how you would want to display your contacts from the Contacts settings. Such display options include displaying only those contacts with phones, sorting list by first/last name, or viewing contact names as first/last names first. To set up your Contacts settings, tap  > **Settings** from the Contacts app.

Setting up your profile

Make your ASUS Phone truly your own and set up your profile info.

1. Launch the Contacts app then tap  > **Settings** > **Your info**.
2. Fill in your info such as mobile or home number. To add other info, tap **More fields**.
3. When you've completed your info, tap **SAVE**.

Adding contacts

Add contacts to your device, corporate, Google, or other email accounts and fill in more important contact information such as contact numbers, email addresses, special events for VIPs, and more.

1. Launch the Contacts app then tap  .
2. Select **Device**.

NOTES:

- You can also save the contact to your SIM card or an email account.
 - If you don't have an email account, tap **Add account** then create one.
-

3. Fill in the necessary information such as name, mobile or home number, and email address.
4. If you want to add other contact information, tap **More fields**.
5. When you've completed the info, tap **SAVE**.

Adding an extension number to a contact number

You can add a contact's extension number to skip the voice prompts when making a call.

1. In the contact's information screen, enter the contact's main number and extension number in either of these two ways:
 - Insert a comma (,) after the main number, then enter the contact's extension number. There'll be a short pause before the extension number is dialed automatically. To extend the pause, tap **Pause** to insert another comma.
 - Insert a semi-colon (;) after the main number, then enter the contact's extension number. When dialing the contact number, you'll be prompted to confirm the extension number. Tap **Yes** on the confirmation message.
2. When you've completed the info, tap **SAVE**.

Customizing your contact's profile

Edit your contact's info, add a photo, set a ringtone, or take a photo as a cover for your contact's profile.

1. Launch the Contacts app then select the contact whose info or profile you want to edit or customize.
2. Make the changes from the contact's profile page.

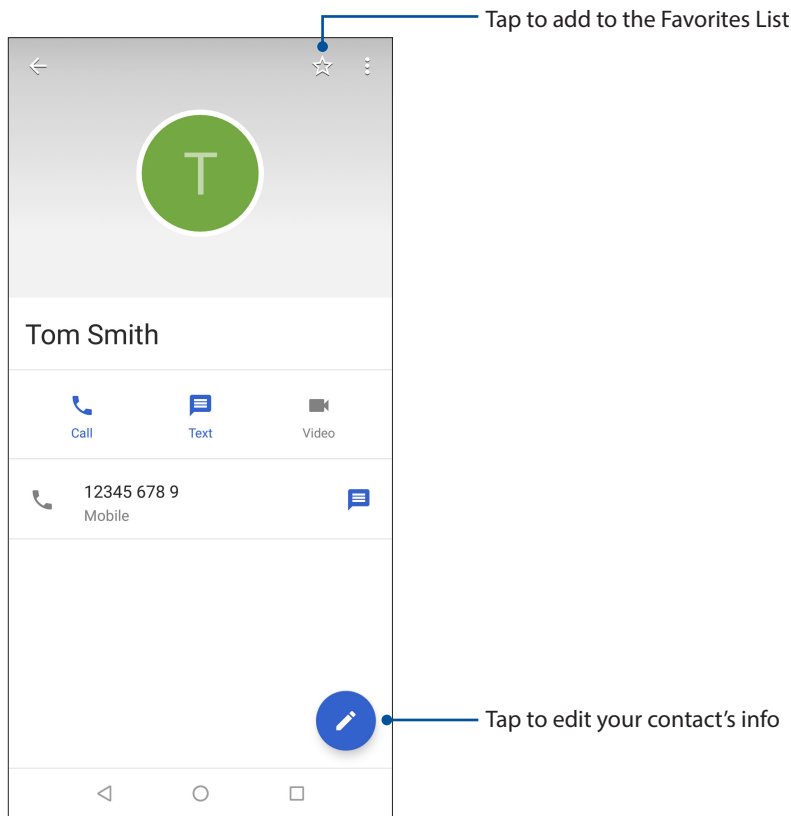

Marking your favorite contacts

Set your frequently-called contacts as your favorites to be able to call them quickly from the Phone app.

1. Swipe up from the lower part of your Home screen then tap **Contacts**.
2. Select the contact that you want to mark as a favorite.
3. Tap . The contact is added to your Favorites List in the Phone app.

NOTES:

- To view your Favorites list, tap  from the Home screen, then tap **Favorites**.
 - For more details, refer to the section [Calling your favorite contacts](#).
-

Managing your block list

Blocking numbers

Create your list of blocked numbers to avoid receiving any unwanted calls or messages. Your blocked calls and messages will be saved to the Block List archive.

1. Swipe up from the lower part of your Home screen then tap **Contacts** then tap  > **Settings** > **Blocked numbers**.
2. Tap **ADD A NUMBER**.
3. Enter the number that you want to block.
4. When done, tap **BLOCK**.

Unblocking numbers

You may remove a blocked number from your list and receive calls or messages from the number again.

1. Swipe up from the lower part of your Home screen then tap **Contacts** then tap  > **Settings** > **Blocked numbers**.
2. Tap **×** beside the number that you want to unblock.
3. Tap **UNBLOCK**.

Social networking with your contacts

Integrating the social network accounts of your contacts makes it easier for you to view their profiles, news, and social feeds. Stay updated with the activities of your contacts in real time.

IMPORTANT! Before you can integrate social network accounts of your contacts, you need to log in to your social network account and sync its settings.

Syncing your social network account

Sync your social network account to add the social network accounts of your contacts to your ASUS Phone.

1. Do any of the following to launch the Settings app:
 - Launch Quick Settings then tap .
 - Swipe up from the lower part of your Home screen then tap **Settings**.
2. From the Settings screen, tap your social network account under **Users & accounts** section.
3. Slide **Automatically sync data** to **ON** to sync the social network accounts of your contacts.
4. Launch the Contacts app to view your contacts list. Tap the contact, you will see which social network the contact is from.

Send messages and more

Messages

Messages, an intuitive and delightful app, lets you send/receive SMS/MMS messages, as well as send group texts, photos, or audio messages. You can add emojis or stickers to your messages, share your location, archive your messages, and easily block SMS senders. You can also take photos or record videos and easily share these files.

Sending messages

1. Swipe up from the lower part of your Home screen then tap **Messages**.
2. Tap , then select the contact whom you want to send a message to.
3. Start composing your message in the message field.
4. When you're done, select the SIM account where you're going to send your message from.

Replying to messages

1. Tap your message alert from your Home screen or Lock screen.
2. Start composing your reply in the message field.
3. When you're done, select the SIM account where you're going to send your reply from.

Fun and entertainment

5

Using a headset

Have the freedom to do other things while you're in a call or enjoy listening to your favorite music, using a headset.

Connecting the audio jack

Insert the 3.5mm headset jack into the audio port of your device.

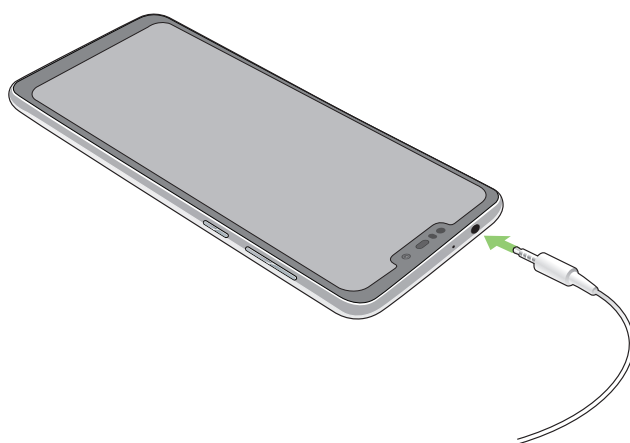

WARNING!

- Do not insert other objects into the audio jack port.
- Do not insert a cable with electric power output into the audio jack port.
- Listening at a high volume for long periods can damage your hearing.

NOTES:

- We highly recommend to use only compatible headsets or the bundled headset with this device.
 - Unplugging the audio jack while listening to music, automatically pauses the music played.
 - Unplugging the audio jack while watching a video, automatically pauses the video playback.
-

Google Play Music

With Google Play Music, you can stream your favorite music, create playlists, or listen to the radio. You can also store up to 50,000 music files to the cloud for free. You can also subscribe to Google Play Music for unlimited and ad-free access to millions of music files that you can add to your own music library.

Setting up your Google Play Music

Sign in to your Google or Gmail account to be able to use Google Play Music. Once you've signed in to your account, all music files on your ASUS Phone, including the uploaded or purchased ones from Google Play, are added to your library.

To set up your Google Play Music:

1. From the Home screen, **Google > Play Music**.
2. Tap  then tap **Settings > Tap to choose account**.
3. Enter your account, then tap **ADD ACCOUNT**.
4. Follow the next instructions to sign in to your account.

NOTES:

- Google Play Music subscription is only available in some countries or region.
 - For more details on using Google Play Music, visit <https://support.google.com>.
-

Your precious moments

6

Capture moments

Launching the Camera app

Capture images and record videos using your ASUS Phone's Camera app. Refer to any of the steps below to open the Camera app.

From the lock screen

Drag  to any direction until the camera app is launched.

From the home screen

Tap .

Camera home screen

Your ASUS Phone's camera is equipped with auto-scene detection and auto-image stabilizer features. It also features a video stabilization function that helps prevent shakiness while video recording.

Tap the icons to start using your camera and explore the image and video features of your ASUS Phone.

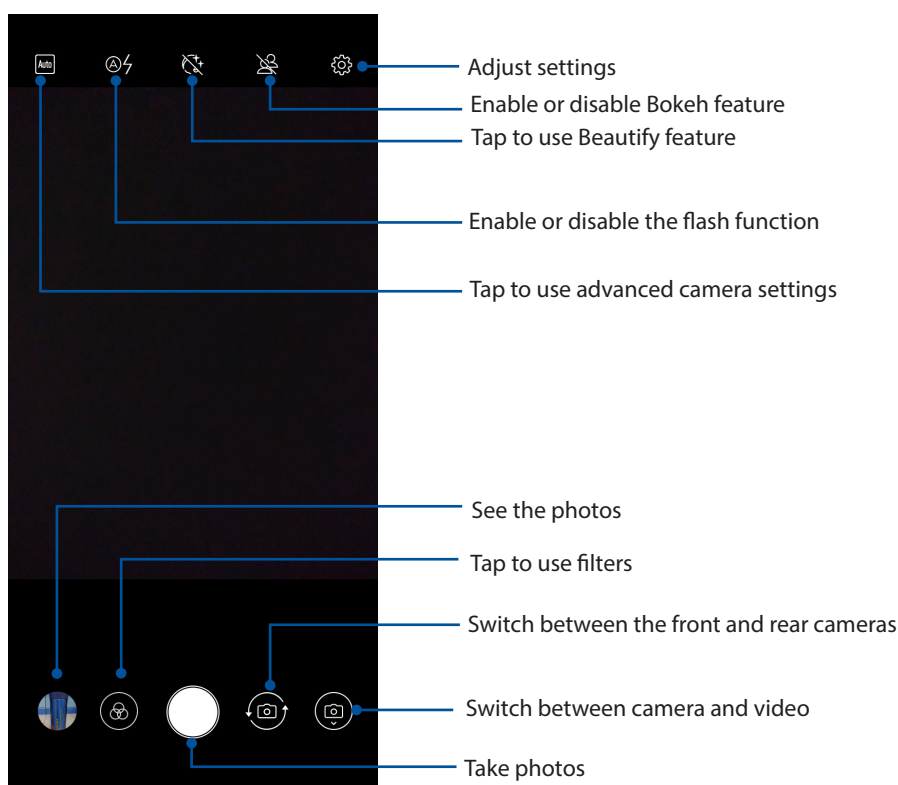



Photo Locations

To enable the location tagging feature, refer to the following steps:

1. Turn on the location access from **Settings > Security & location > Location > App-level permissions**.
2. Ensure that you have shared your location to Google Map.
3. From the Camera app's home screen, tap  and activate **GPS location** before you take the photo.

Using the Photos

View images and play videos on your ASUS Phone using the Photos app.

This app also allows you to edit, share, or delete image and video files stored in your ASUS Phone. From Photos, you can display images in a slideshow or tap to view the selected image or video file.

To launch Photos, swipe up from the lower part of your Home screen then tap **Photos**.



Viewing the photo location

Enable the location access on your ASUS Phone, and get the location details on your photos. Your photos' location details include the area where the photos are taken, as well a map of the location via Google Map or Baidu (in China only).



To view the details of a photo:

1. Turn on the location access from **Settings > Security & location > Location > App-level permissions**.
2. Ensure that you have shared your location to Google Map or Baidu.
3. Launch the Photos app, and select the photo whose photo details you want to view.
4. Tap the photo then tap .

Sharing files from the Photos

1. From the Photos screen, tap the folder where the files you want to share are located.
2. After opening the folder, tap  > **Select** to activate file selection.
3. Tap the files you want to share. A check mark appears on top of the image you select.
4. Tap  then select from the list where you want to share the images.

Deleting files from the Photos

1. From the Photos screen, tap the folder where the files you want to delete are located.
2. After opening the folder, tap  > **Select** to activate file selection.
3. Tap the files you want to delete. A check mark appears on top of the image you select.
4. Tap .

Editing images

The Photos also features its own image editing tools that you can use to enhance images saved on your ASUS Phone.

1. From the Photos screen, tap the folder where the files are located.
2. After opening the folder, tap the image you want to edit.
3. Once the image is opened, tap it again to show its functions.
4. Tap  to open the image editing toolbar.
5. Tap any of the icons on the editing toolbar to apply changes to the image.

Staying connected

7

Mobile network

When there's no available Wi-Fi network that you can connect to, you can enable your mobile network's data access for Internet connection.

Enabling the mobile network

1. Do any of the following to launch the Settings screen:
 - Launch Quick Settings then tap .
 - Swipe up from the lower part of your Home screen then tap **Settings**.
2. Tap **Network & Internet** > **Mobile network**.
3. Slide **Mobile data** to **ON**, and configure the other mobile network settings, if necessary.

NOTES:

- If you access the Internet via your mobile network, additional charges will be incurred depending on your data plan.
 - For more details on your mobile network charges/fees and settings, contact your mobile service provider.
-

Wi-Fi

The Wi-Fi technology of your ASUS Phone gets you connected to the wireless world. Update your social media accounts, browse the Internet, or exchange data and messages wirelessly from your ASUS Phone.

Enabling Wi-Fi

1. Launch the Settings screen by doing any of the following:
 - Launch Quick Settings then tap  > **Network & Internet**.
 - Swipe up from the lower part of your Home screen then tap **Settings** > **Network & Internet**.
2. Slide the Wi-Fi switch to the right to turn on the Wi-Fi.

NOTE: You can also enable the Wi-Fi from Quick Settings screen. Refer to section [Quick Settings](#) on how to launch Quick Settings screen.

Connecting to a Wi-Fi network

1. On the Settings screen, tap **Wi-Fi** to display all detected Wi-Fi networks.
2. Tap a network name to connect to it. For a secured network, you may be prompted to key in a password or other security credentials.

NOTES:

- Your ASUS Phone automatically reconnects to the network that you connected with previously.
 - Turn off the Wi-Fi feature when you're not using it to help save battery power.
-

Disabling Wi-Fi

To disable Wi-Fi:

1. Launch the Settings screen by doing any of the following:
 - Launch Quick Settings then tap  > **Network & Internet**.
 - Swipe up from the lower part of your Home screen then tap **Settings** > **Network & Internet**.
2. Slide the Wi-Fi switch to the left to turn off the Wi-Fi.

NOTE: You can also disable the Wi-Fi from Quick Settings screen. See [Quick Settings](#) on how to launch Quick Settings screen.

Bluetooth®

Use the Bluetooth feature of your ASUS Phone to send or receive files and stream multimedia files with other smart devices over short distances. With Bluetooth, you can share your media files with your friends' smart devices, send data for print with a Bluetooth printer, or play music files with a Bluetooth speaker.

Enabling Bluetooth®

1. Do any of the following to launch the Settings screen:
 - Launch Quick Settings then tap  > **Connected devices**.
 - Swipe up from the lower part of your Home screen then tap **Settings** > **Connected devices**.
2. Slide the Bluetooth switch to the right to turn on the Bluetooth.

NOTE: You can also enable the Bluetooth from Quick Settings screen. See [Quick Settings](#) on how to launch Quick Settings screen.

Pairing your ASUS Phone to a Bluetooth® device

Before using the Bluetooth feature of your ASUS Phone in full scale, you have to pair it first with the Bluetooth device. The ASUS Phone automatically stores the pairing connection of the Bluetooth device.

1. On the Settings screen, tap **Bluetooth** to display all available devices.

IMPORTANT!

- If the device that you want to pair is not in the list, ensure to enable its Bluetooth feature and is discoverable.
 - See the user guide that came with your device to learn how to enable its Bluetooth and set it to discoverable.
-

2. Tap **Pair new device** to scan for more Bluetooth devices.
3. In the list of available devices, tap the Bluetooth device that you want to pair with.
4. Ensure that the same passkey show on both devices, then tap **PAIR**.

NOTE: Turn off the Bluetooth feature when you're not using it to help save battery power.

Unpairing your ASUS Phone from the Bluetooth® device

1. On the Settings screen, tap Bluetooth to display all available and paired devices.
2. In the list of paired devices, tap  of Bluetooth device that you want to unpair, then tap **FORGET**.

Tethering

When Wi-Fi service is not available, you can use your ASUS Phone as a modem or turn it into a Wi-Fi hotspot to get Internet access on your laptop, tablet, and other mobile devices.

IMPORTANT! Most mobile service providers may require a data plan for you to be able to use the tethering function. Contact your mobile service provider about availing of this data plan.

NOTES:

- Internet access via tethering may be slower than the standard Wi-Fi or mobile connection.
 - Only a limited number of mobile devices can tether to your ASUS Phone for Internet access.
 - Turn off the tethering feature when you're not using it to help save battery power.
-

Wi-Fi Hotspot

Turn your ASUS Phone into a Wi-Fi Hotspot to share Internet connection with other devices.

1. Do any of the following to launch the Settings screen:
 - Launch Quick Settings then tap  > **Network & Internet**.
 - Swipe up from the lower part of your Home screen then tap **Settings** > **Network & Internet**.
2. Tap **Hotspot & tethering** then slide **Wi-Fi hotspot** to **ON**.
3. Tap **Set up Wi-Fi hotspot** then assign a unique SSID or network name and a strong 8-character password for your Wi-Fi hotspot. When done, tap **Save**.

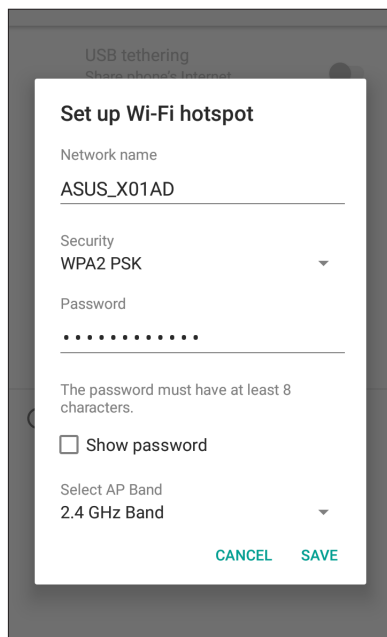

4. Connect other devices to your ASUS Phone's hotspot connection the same way you connect to a Wi-Fi network.

USB Tethering

Enable USB tethering on your ASUS Phone and share its Internet connection with other devices.

1. Connect your ASUS Phone to another device with a USB cable.
2. From the Settings screen, tap **Network & Internet** > **Hotspot & tethering**, then slide **USB tethering** to **ON** to enable tethering.

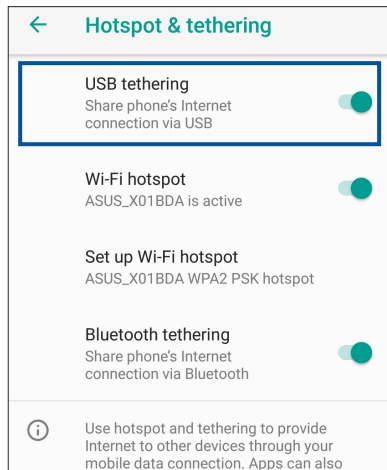

Bluetooth Tethering

Enable Bluetooth tethering on your ASUS Phone to share its Internet connection with other devices.

1. Enable Bluetooth on your ASUS Phone and the other device.
2. Pair both devices.

NOTE: For details, see [Pairing your ASUS Phone to a Bluetooth® device](#).

3. From the Settings screen, tap **Network & Internet** > **Hotspot & tethering**, then slide **Bluetooth tethering** to **ON**.

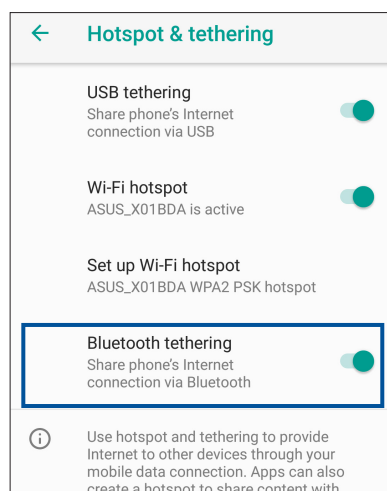

Travel and Maps

8

Clock

Customize the time zone settings of your ASUS Phone, set alarms, and use your ASUS Phone as a stop watch using the Clock app.

Launching Clock

To launch the Clock app, swipe up from the lower part of your Home screen then tap **Clock**.

Clock

Tap **CLOCK** to access the world clock settings of your ASUS Phone.

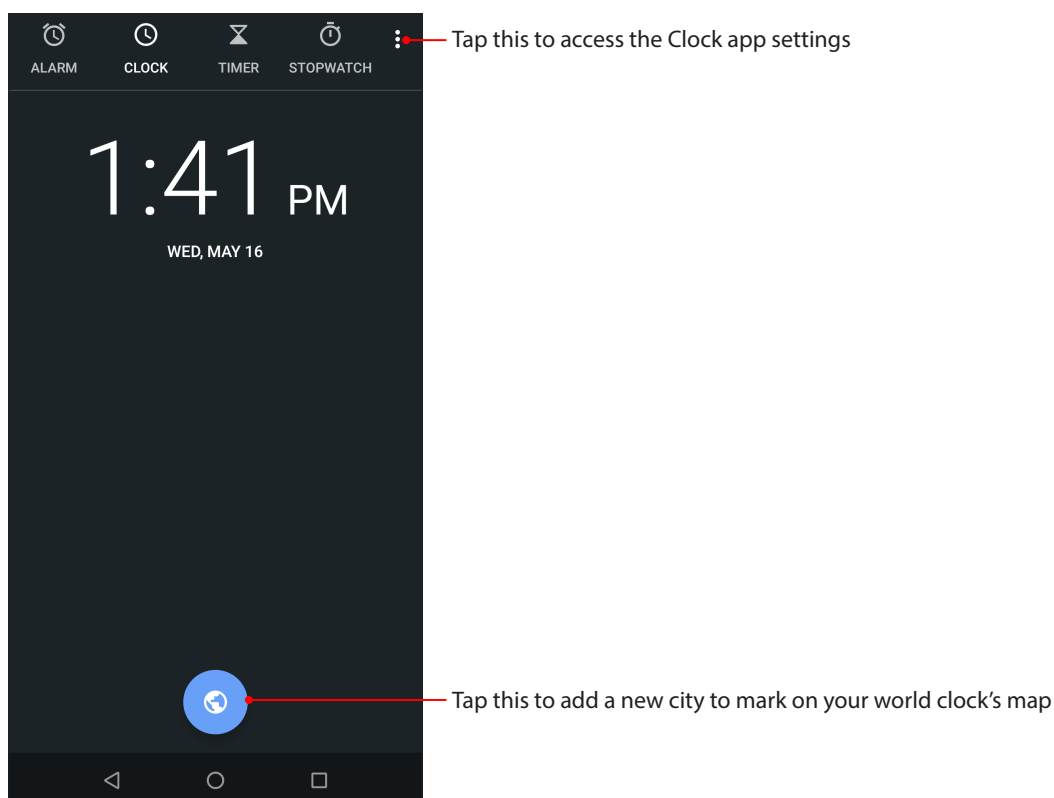

Alarm clock

Tap **ALARM** to access the alarm clock settings of your ASUS Phone.

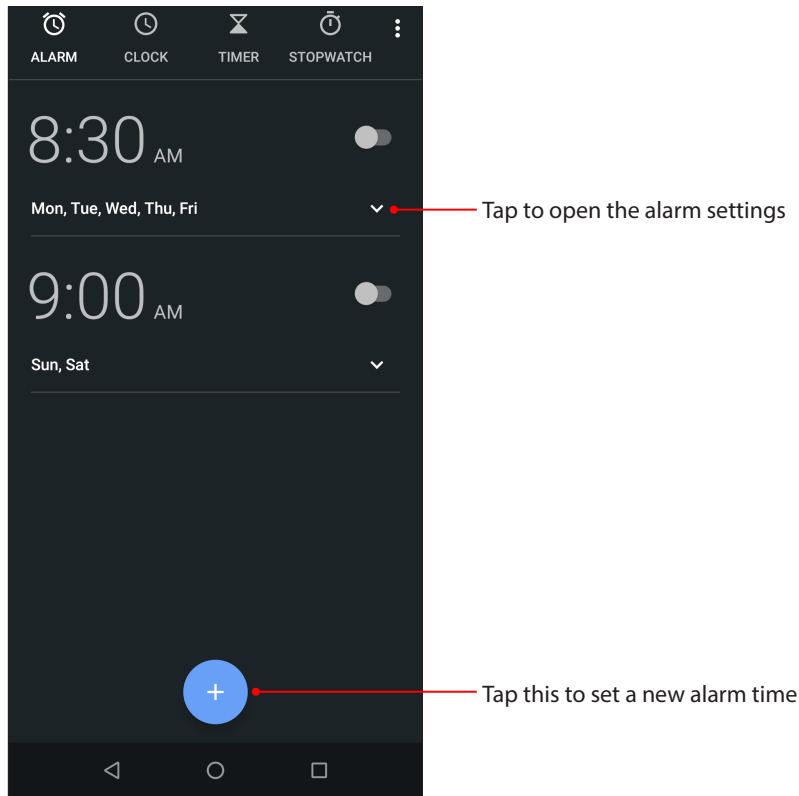

Stopwatch

Tap **STOPWATCH** to use your ASUS Phone as a stopwatch.

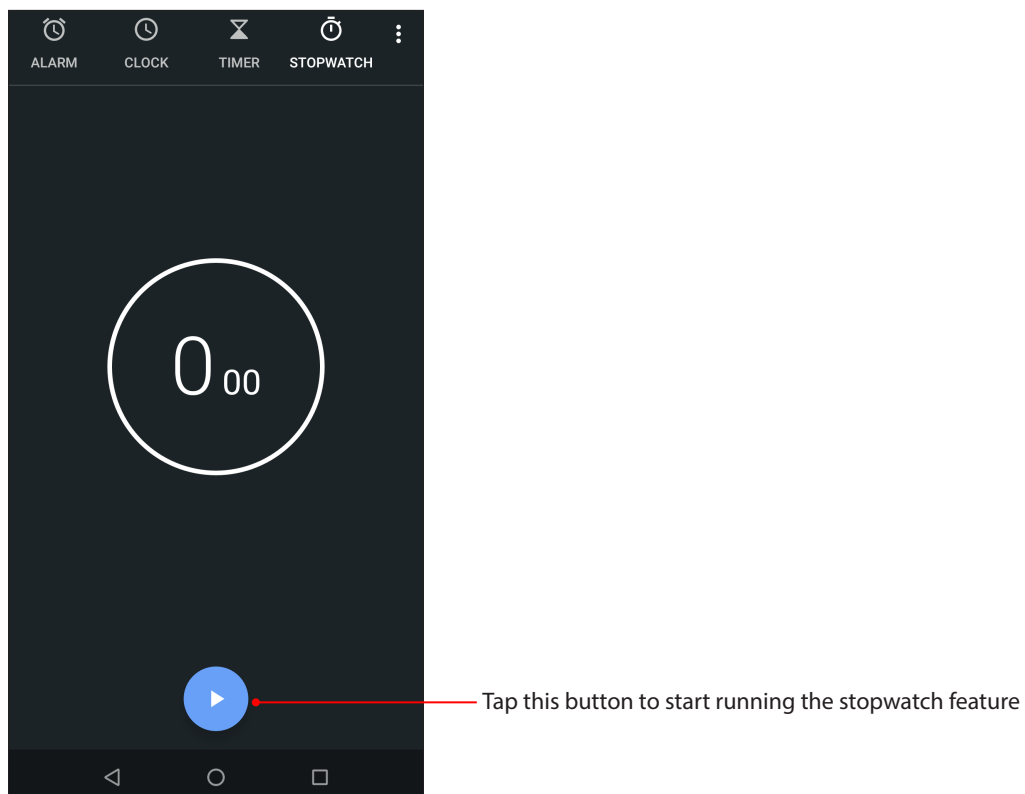

Timer

You may set multiple timer options for your ASUS Phone. To do this, follow the steps below:

Setting the timer

Tap **TIMER** to access the timer feature of your ASUS Phone.

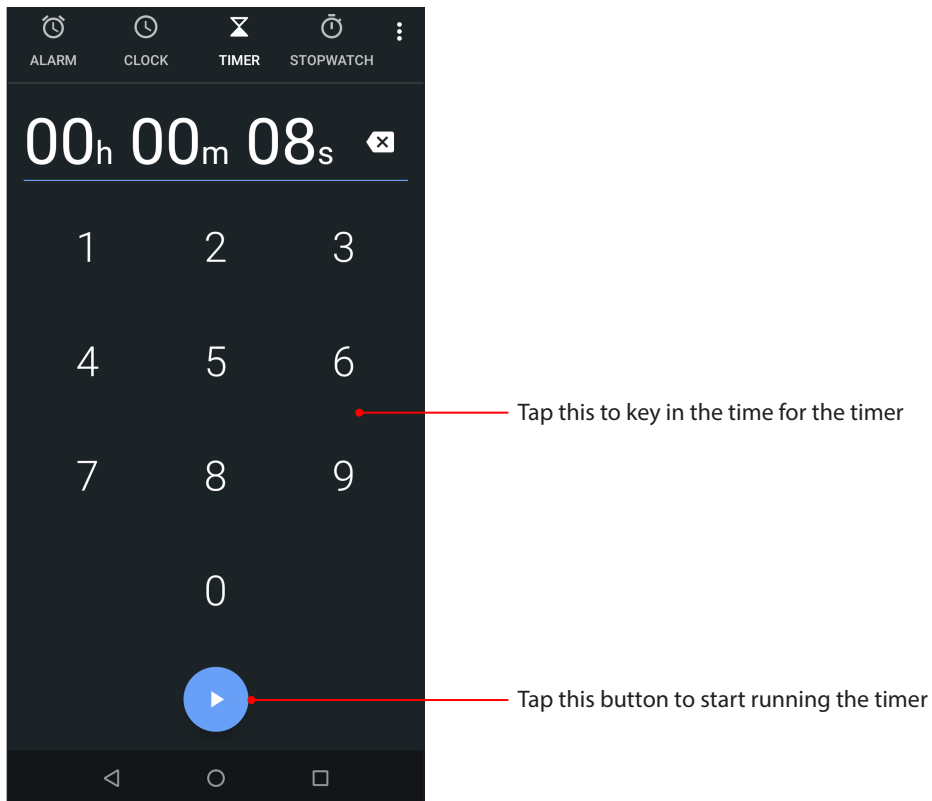

Special Zen Tools

Calculator

Calculate using your ASUS phone by enabling the Calculator app

Launching Calculator

To launch Calculator, swipe up from the lower part of your Home screen then tap **Calculator**.

Calculator screen

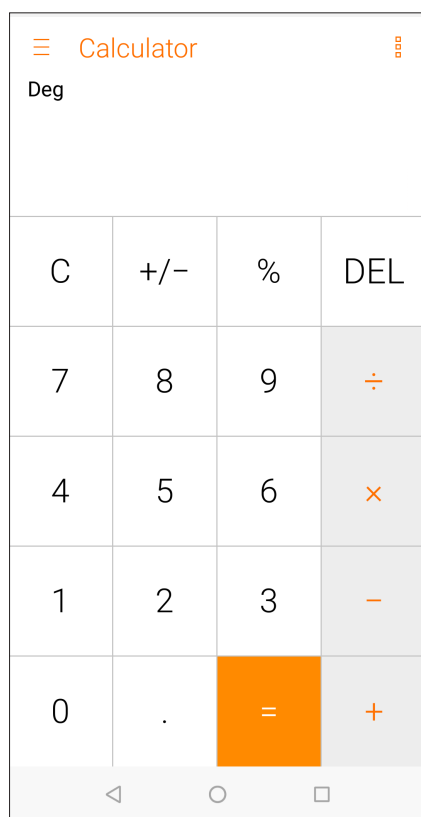

Sound Recorder

Record audio files using your ASUS Phone by enabling the Sound Recorder app.

Launching Sound Recorder

To launch Sound Recorder, swipe up from the lower part of your Home screen then tap **Sound Recorder**.

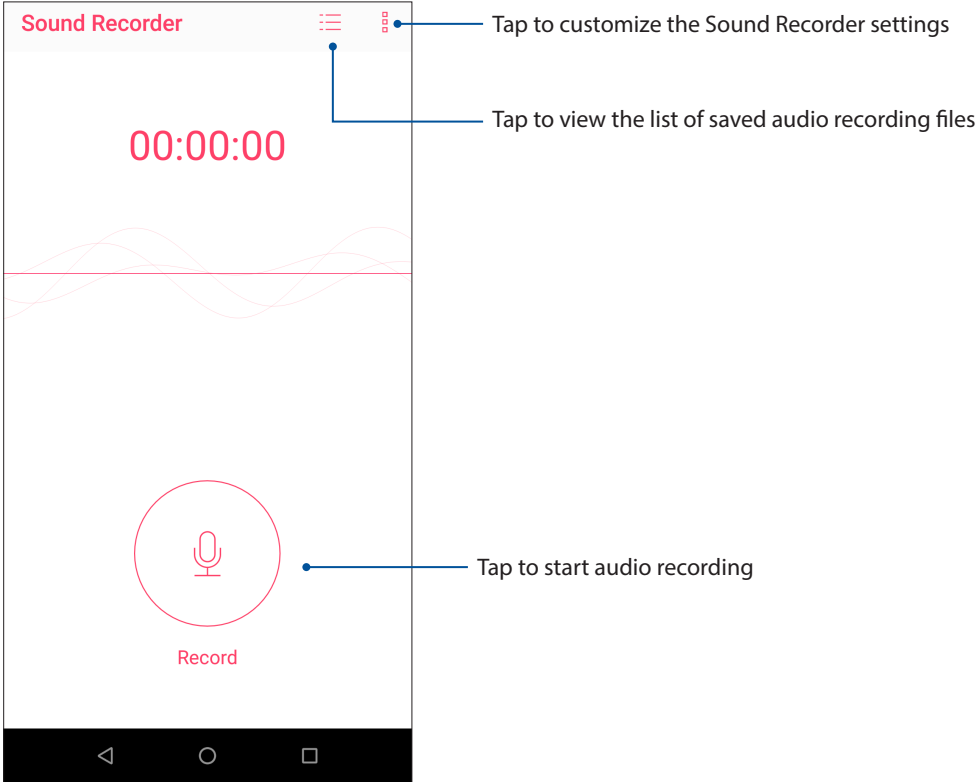

Pausing a recording

During a paused recording, you can choose to resume, delete, or save the recording.

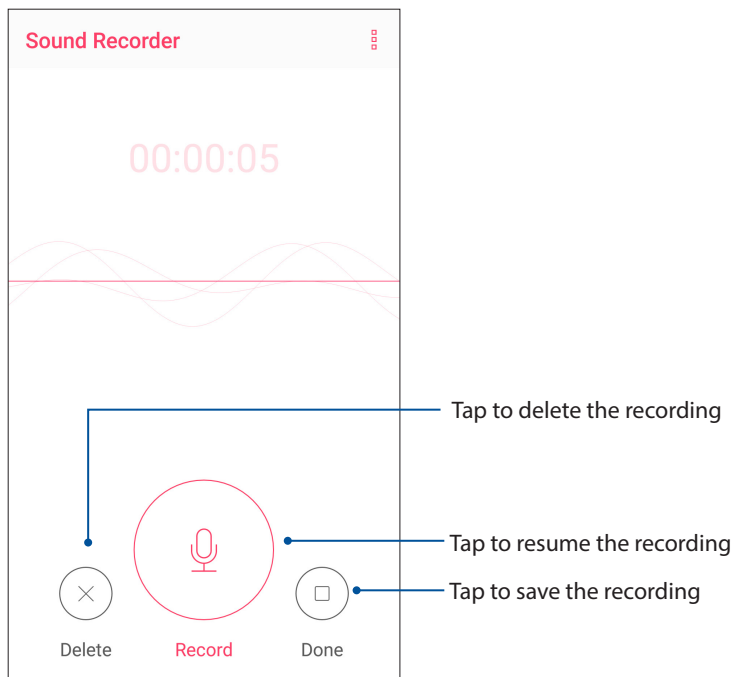

Recording List

From the Recording List, you can play, rename, share, or delete a saved audio recording file.

To view your recording list, tap  from the Sound Recorder main screen.

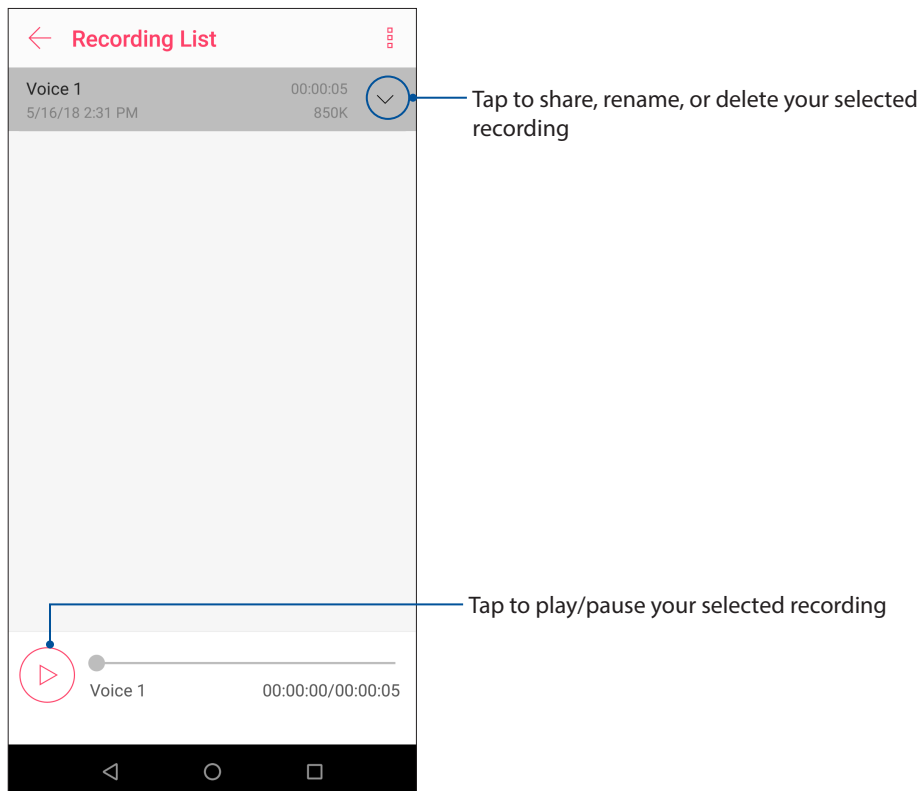

Keeping your device up-to-date

Keep your ASUS Phone in the loop of Android system updates and upgraded apps and features.

Updating your system

1. Swipe up from the lower part of your Home screen then tap **Settings**.
2. On the Settings screen, slide down to display other items then tap **System > System update** to check for system updates.
3. Tap  on the System updates screen to set up automatic download of system updates.

NOTE: You can preview the last time your ASUS Phone's system was updated at the Last update check: of the System update window.

Storage

You can store data, apps, or files on your ASUS Phone (internal storage), on an external storage, or on an online storage. You need an internet connection to transfer or download your files on an online storage. Use the bundled USB cable to copy files to or from the computer to your ASUS Phone.

Backup

Back up data, Wi-Fi passwords, and other settings to Google servers using your ASUS Phone.

1. Swipe up from the lower part of your Home screen then tap **Settings > System > Backup**.
2. From the Backup window, you can:
 - **Back up to Google Drive:** This feature backs up your data, Wif-Fi passwords, and other settings to Google Drive when enabled.
 - **Backup account:** Allows you to specify the account you to be associated when you save your backup.

Reset

Reset network settings and app preferences, or reset factory defaults.

1. Swipe up from the lower part of your Home screen then tap **Settings > System > Reset options**.

2. From the Reset window, you can:

- **Reset Wi-Fi, mobile & Bluetooth:** This feature restores Wi-Fi passwords, and other network settings.
- **Reset app preferences:** This feature facilitates restoration of backed up settings and data when you reinstall an app.
- **Erase all data(factory reset):** Erases all data on phone.

Securing your ASUS Phone

Use the security features of your ASUS Phone to prevent unauthorized calls or access of information.

Unlocking your screen

When the screen is locked, you can open it with the security unlocking options that the ASUS Phone offers you.

1. Swipe up from the lower part of your Home screen then tap **Settings > Security & location**.
2. Tap **Screen lock** then select an option to unlock your ASUS Phone.

NOTES:

- Refer to section **Unlock screen options** for more information.
 - To deactivate the unlock screen option that you set, tap **None** on Choose screen lock screen.
-

Unlock screen options

Choose from these options to lock your ASUS Phone.

Swipe

Swipe up to unlock your ASUS Phone.

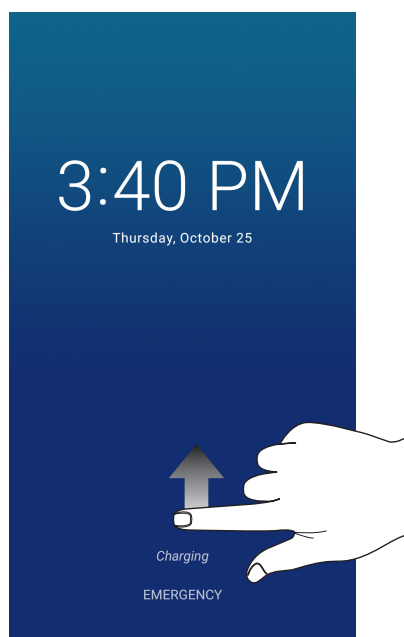

PIN

Key in at least four numbers to set a PIN.

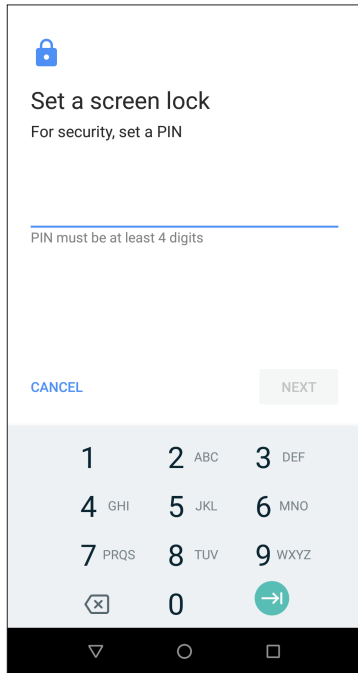

IMPORTANT! Ensure to remember the PIN that you created to unlock your device.

Pattern

Slide your finger on the dots and create a pattern.

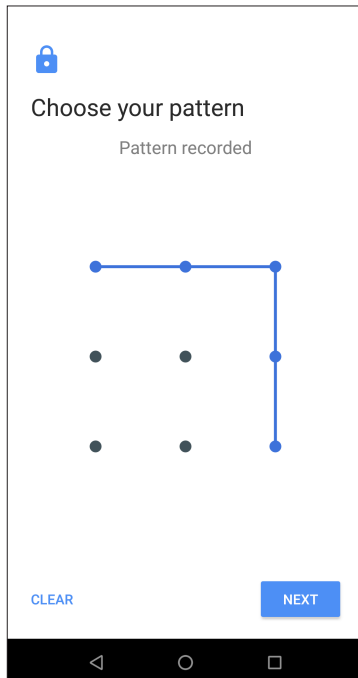

IMPORTANT! You can create a pattern with a minimum of four dots. Ensure to remember the pattern that you created to unlock your device.

Password

Key in at least four characters to create a password.

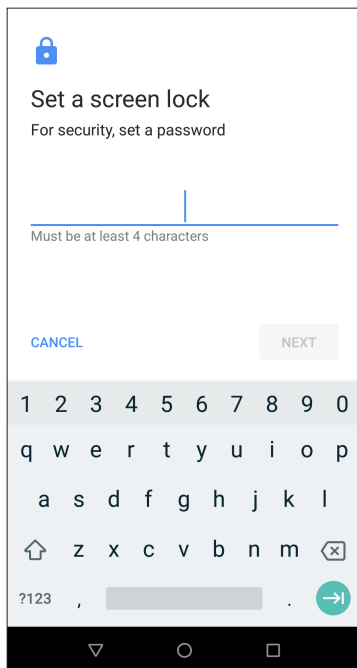

IMPORTANT! Ensure to remember the password that you created to unlock your device.

Setting your ASUS Phone identity

Know your ASUS Phone's identity such as serial number, IMEI (International Mobile Equipment Identity) number, or model number.

This is important, as when you may lose your ASUS Phone, you can contact your mobile carrier and provide the information to blacklist the unauthorized use of your ASUS Phone.

To display your ASUS Phone's identity:

1. Swipe up from the lower part of your Home screen then tap **Settings**.
2. On the Settings screen, slide down to display other items then tap **System > About phone**. The About screen displays the status, legal information, model number, operating system version, hardware, and software information of your ASUS Phone.
3. To see the serial number, SIM contact number, and IMEI of your ASUS Phone, tap **Status**.

Appendix

Safety information

CAUTION! Use of controls or adjustments or performance of procedures other than those specified herein may result in hazardous radiation exposure.

ASUS Phone care

- Use your ASUS Phone in an environment with ambient temperatures between 0 °C (32 °F) and 35 °C (95 °F).

The battery

WARNING: Disassembling the battery by yourself will void its warranty and may cause serious harm.

Your ASUS Phone is equipped with a high performance non-detachable Li-polymer battery. Observe the maintenance guidelines for a longer battery life.

- Do not remove the non-detachable Li-polymer battery as this will void the warranty.
- Avoid charging in extremely high or low temperature. The battery performs optimally in an ambient temperature of +5 °C to +35 °C.
- Do not remove and replace the battery with a non-approved battery.
- Use only ASUS battery. Using a different battery may cause physical harm/injury and may damage your device.
- Do not remove and soak the battery in water or any other liquid.
- Never try to open the battery as it contains substances that might be harmful if swallowed or allowed to come into contact with unprotected skin.
- Do not remove and short-circuit the battery, as it may overheat and cause a fire. Keep it away from jewelry or metal objects.
- Do not remove and dispose of the battery in fire. It could explode and release harmful substances into the environment.
- Do not remove and dispose of the battery with your regular household waste. Take it to a hazardous material collection point.
- Do not touch the battery terminals.

- To avoid fire or burns, do not disassemble, bend, crush, or puncture the battery.

NOTES:

- Risk of explosion if battery is replaced by an incorrect type.
 - Dispose of used battery according to the instructions.
-

The charger

- Use only the charger supplied with your ASUS Phone.
- Never pull the charger cord to disconnect it from the power socket. Pull the charger itself.

Caution

Your ASUS Phone is a high quality piece of equipment. Before operating, read all instructions and cautionary markings on the (1) AC Adapter.

- Do not use the ASUS Phone in an extreme environment where high temperature or high humidity exists. The ASUS Phone performs optimally in an ambient temperature between 0 °C (32 °F) and 35 °C (95 °F).
- Do not disassemble the ASUS Phone or its accessories. If service or repair is required, return the unit to an authorized service center. If the unit is disassembled, a risk of electric shock or fire may result.
- Do not short-circuit the battery terminals with metal items.

Operator access with a tool

If a TOOL is necessary to gain access to an OPERATOR ACCESS AREA, either all other compartments within that area containing a hazard shall be inaccessible to the OPERATOR by the use of the same TOOL, or such compartments shall be marked to discourage OPERATOR access.

Notices

Federal Communications Commission Statement

This device complies with part 15 of the FCC Rules. Operation is subject to the following two conditions: (1) This device may not cause harmful interference, and (2) this device must accept any interference received, including interference that may cause undesired operation.

Changes or modifications not expressly approved by the party responsible for compliance could void the user's authority to operate the equipment.

This equipment has been tested and found to comply with the limits for a Class B digital device, pursuant to part 15 of the FCC Rules. These limits are designed to provide reasonable protection against harmful interference in a residential installation. This equipment generates, uses and can radiate radio frequency energy and, if not installed and used in accordance with the instructions, may cause harmful interference to radio communications. However, there is no guarantee that interference will not occur in a particular installation. If this equipment does cause harmful interference to radio or television reception, which can be determined by turning the equipment off and on, the user is encouraged to try to correct the interference by one or more of the following measures:

- Reorient or relocate the receiving antenna.
- Increase the separation between the equipment and receiver.
- Connect the equipment into an outlet on a circuit different from that to which the receiver is connected.
- Consult the dealer or an experienced radio/TV technician for help.

The antenna(s) used for this transmitter must not be co-located or operated in conjunction with any other antenna or transmitter.

The country code selection is for non-US models only and is not available to all US models. Per FCC regulation, all WiFi products that are marketed in US must be fixed to US-operated channels only.

The responsible party within the USA per 47 CFR Part 2.1077(a)(3):

ASUS COMPUTER INTERNATIONAL (America)

Address: 48720 Kato Rd, Fremont, CA 94538

Telephone: +1-510-739-3777

RF Exposure Information (SAR)

This device has been tested and meets applicable limits for Radio Frequency (RF) exposure.

Specific Absorption Rate (SAR) refers to the rate at which the body absorbs RF energy. SAR limits are 1.6 Watts per kilogram (over a volume containing a mass of 1 gram of tissue) in countries that follow the United States FCC limit and 2.0 W/kg (averaged over 10 grams of tissue) in countries that follow the Council of the European Union limit. Tests for SAR are conducted using standard operating positions with the device transmitting at its highest certified power level in all tested frequency bands.

To reduce exposure to RF energy, use a hands-free accessory or other similar option to keep this device away from your head and body. Carry this device at least 10 mm away from your body to ensure exposure levels remain at or below the as-tested levels. Choose the belt clips, holsters, or other similar body-worn accessories which do not contain metallic components to support operation in this manner. Cases with metal parts may change the RF performance of the device, including its compliance with RF exposure guidelines, in a manner that has not been tested or certified, and use such accessories should be avoided.

The highest FCC SAR values for the device are as follows:

- 1.04 W/Kg @1g(Head)
- 0.99 W/Kg @1g(Body)

The FCC has granted an Equipment Authorization for this device with all reported SAR levels evaluated as in compliance with the FCC RF exposure guidelines. SAR information on this device is on file with the FCC and can be found under the Display Grant section of www.fcc.gov/oet/ea/fccid after searching on FCC ID: MSQX01AD.

FCC Statement (HAC)

This phone has been tested and rated for use with hearing aids for some of the wireless technologies that it uses. However, there may be some newer wireless technologies used in this phone that have not been tested yet for use with hearing aids. It is important to try the different features of this phone thoroughly and in different locations, using your hearing aid or cochlear implant, to determine if you hear any interfering noise. Consult your service provider or the manufacturer of this phone for information on hearing aid compatibility. If you have questions about return or exchange policies, consult your service provider or phone retailer.

The Federal Communications Commission has implemented rules and a rating system designed to enable people who wear hearing aids to more effectively use these wireless telecommunications devices. The standard for compatibility of digital wireless phones with hearing aids is set forth in American National Standard Institute (ANSI) standard C63.19-2011. There are two sets of ANSI standards with ratings from one to four (four being the best rating): an "M" rating for reduced interference making it easier to hear conversations

on the phone when using the hearing aid microphone, and a "T" rating that enables the phone to be used with hearing aids operating in the telecoil mode thus reducing unwanted background noise.

The Hearing Aid Compatibility rating is displayed on the wireless phone box.

A phone is considered Hearing Aid Compatible for acoustic coupling (microphone mode) if it has an "M3" or "M4" rating. A digital wireless phone is considered Hearing Aid Compatible for inductive coupling (telecoil mode) if it has a "T3" or "T4" rating.

The tested M-Rating and T-Rating for this device are M3 and T3.

You'll want to try a number of wireless phones so that you can decide which works the best with your hearing aids. You may also want to talk with your hearing aid professional about the extent to which your hearing aids are immune to interference, if they have wireless phone shielding, and whether your hearing aid has a HAC rating.

Canada, Industry Canada (IC) Notices

This device complies with Industry Canada's licence-exempt RSS standard(s). Operation is subject to the following two conditions:

- (1) This device may not cause interference; and
- (2) This device must accept any interference, including interference that may cause undesired operation of the device.

Le présent appareil est conforme aux normes CNR d'Industrie Canada applicables aux appareils radio exempts de licence. Son utilisation est sujette aux deux conditions suivantes :

- (1) Cet appareil ne doit pas créer d'interférences nuisibles, et
- (2) Cet appareil doit tolérer tout type d'interférences, y compris celles susceptibles de provoquer un fonctionnement non souhaité de l'appareil.

Radio Frequency (RF) Exposure Information

The radiated output power of the Wireless Device is below the Industry Canada (IC) radio frequency exposure limits. The Wireless Device should be used in such a manner such that the potential for human contact during normal operation is minimized. This device has been evaluated for and shown compliant with the IC Specific Absorption Rate ("SAR") limits when installed in specific host products operated in portable exposure conditions.

Canada's REL (Radio Equipment List) can be found at the following web address: <http://www.ic.gc.ca/app/sitt/reltel/srch/nwRdSrch.do?lang=eng>.

Additional Canadian information on RF exposure also can be found at the following web address: <http://www.ic.gc.ca/eic/site/smt-gst.nsf/eng/sf08792.html>.

This equipment should be installed and operated with minimum distance 10 mm between the radiator and your body.

Informations concernant l'exposition aux fréquences radio (RF)

La puissance de sortie émise par cet appareil sans fil est inférieure à la limite d'exposition aux fréquences radio d'Industrie Canada (IC). Utilisez l'appareil sans fil de façon à minimiser les contacts humains lors d'un fonctionnement normal.

Cet appareil été évalué et démontré conforme aux limites de DAS (Débit d'absorption spécifique) d'IC lorsqu'il est installé dans des produits hôtes particuliers qui fonctionnent dans des conditions d'exposition à des appareils portables.

Ce périphérique est homologué pour l'utilisation au Canada. Pour consulter l'entrée correspondant à l'appareil dans la liste d'équipement radio (REL - Radio Equipment List) d'Industrie Canada rendez-vous sur :

<http://www.ic.gc.ca/app/sitt/reldtel/srch/nwRdSrch.do?lang=eng>.

Pour des informations supplémentaires concernant l'exposition aux ondes radio au Canada, rendez-vous sur :

<http://www.ic.gc.ca/eic/site/smt-gst.nsf/eng/sf08792.html>.

Cet appareil doit être installé et utilisé avec un minimum de 10 mm de distance entre la source de rayonnement et votre corps.

CAN ICES-3(B)/NMB-3(B)

This Class B digital apparatus complies with Canadian ICES-003.

Cet appareil numérique de la classe B est conforme à la norme NMB-003 du Canada.

This device and its antenna(s) must not be co-located or operated in conjunction with any other antenna or transmitter, except tested built-in radios. The County Code Selection feature is disabled for products that are marketed in the US/ Canada.

Cet appareil et son ou ses antenne(s) ne doivent pas être situés près de ou utilisés conjointement avec une autre antenne ou un autre émetteur, exception faite des radios intégrées qui ont été testées.

La fonction de sélection de l'indicatif du pays est désactivée pour les produits commercialisés aux États-Unis et au Canada.

The IC ID for this device is 3568A-X01AD.

L'identifiant Industrie Canada de cet appareil est: 3568A-X01AD.

EU Radio Equipment Directive Compliance

Simplified EU Declaration of Conformity

Hereby, ASUSTek Computer Inc. declares that the radio equipment ASUS_X01BDA is in compliance with Directive 2014/53/EU. Full text of EU declaration of conformity is available at <https://www.asus.com/support/>. (Search for ZB633KL)

RF Output Table

Items	Maximum Radio-Frequency Output Power Table	
Bluetooth	Bluetooth BR/EDR (2402~2480 MHz)	9.07 (dBm)
	Bluetooth -LE (2402~2480 MHz)	-2.23 (dBm)
WLAN	2.4GHz 802.11b (2412~2472 MHz)	16.52 (dBm)
	2.4GHz 802.11g (2412~2472 MHz)	14.77 (dBm)
	2.4GHz 802.11n HT20 (2412~2472MHz)	12.91 (dBm)
	2.4GHz 802.11n HT40 (2422~2462MHz)	13.22 (dBm)
GSM	GSM 900 Burst(880~915 ; 925~960 MHz)	32.24 (dBm)
	GSM 1800 Burst (1710~1785 ; 1805~1880 MHz)	30.20 (dBm)
WCDMA	WCDMA Band I (1920~1980 ; 2110~2170 MHz)	23.23 (dBm)
	WCDMA Band V (824~849 ; 869~894 MHz)	23.21 (dBm)
	WCDMA Band VIII (880~915 ; 925~960 MHz)	23.09 (dBm)
LTE	LTE Band 1 (1920~1980 ; 2110~2170 MHz)	23.15 (dBm)
	LTE Band 3 (1710~1785 ; 1805~1880 MHz)	23.26 (dBm)
	LTE Band 5 (824 ~ 849 ; 869 ~ 894 MHz)	23.61 (dBm)
	LTE Band 7 (2500~2570 ; 2620~2690 MHz)	23.43 (dBm)
	LTE Band 8 (880~915 ; 925~960 MHz)	23.7 (dBm)
	LTE Band 20 (832~862 ; 791~821 MHz)	23.62 (dBm)
	LTE Band 40 (2300~2400 MHz)	23.42 (dBm)

NOTE: This RF output power table is for EU member states, the EEA States, the EFTA States and Turkey only. The frequency range and the RF output power may differ from other non-EU countries.

RF Exposure Information

This ASUS product has been tested and meets applicable European SAR limits. The SAR limit is 2.0 W/kg in countries that set the limit averaged over 10 grams of tissue. The specific maximum SAR values for this device are as follows:

ASUS_X01AD(ZB633KL)

- Head: 0.351 W/Kg
- Body: 1.499 W/Kg

When carrying this device or using it while worn on the body, either use an approved accessory such as a holster or otherwise maintain a distance of 0.5 cm from the body to ensure compliance with RF exposure requirements.

CE Marking



Using GPS (Global Positioning System) on your ASUS Phone

To use the GPS positioning feature on your ASUS Phone:

Ensure that your device is connected to the Internet before using Google Map or any GPS-enabled apps.

For first-time use of a GPS-enabled app on your device, ensure that you are outdoors to get the best positioning data.

When using a GPS-enabled app on your device inside a vehicle, the metallic component of the car window and other electronic devices might affect the GPS performance.

General Usage (typical body-worn) (for Japan)

This device ((front & rear side) should be operated under a separation distance of 15 mm from the human body.

* The other four sides are not in close proximity to the human body at the general use as described above.

India E-Waste (Management) Rules 2016

This product complies with the “India E-Waste (Management) Rules, 2016” and prohibits use of lead, mercury, hexavalent chromium, polybrominated biphenyls (PBBs) and polybrominated diphenyl ethers (PBDEs) in concentrations exceeding 0.1% by weight in homogenous materials and 0.01 % by weight in homogenous materials for cadmium, except for the exemptions listed in Schedule II of the Rule.

India BIS - IS 16333 Notice

Language Input : Hindi, English, Tamil

Readability: Assamese, Bangla, Bodo(Boro), Dogri, Gujarati, Hindi, Kannada, Kashmiri, Konkani, Maithili, Malayalam, Manipuri(Bangla), Manipuri(Meetei Mayek), Marathi, Nepali, Oriya, Panjabi, Santhali, Sanskrit, Sindhi (Devanagari) ,Tamil, Telugu, Urdu and English

India E-waste (Management and handling) Rules 2016

This product complies with the “India E-Waste (Management) Rules, 2016” and prohibits use of lead, mercury, hexavalent chromium, polybrominated biphenyls (PBBs) and polybrominated diphenyl ethers (PBDEs) in concentrations exceeding 0.1% by weight in homogenous materials and 0.01 % by weight in homogenous materials for cadmium, except for the exemptions listed in Schedule II of the Rule.

Regional notice for Singapore

Complies with
IMDA Standards
DB103778

This ASUS product complies with IMDA Standards.

Coating notice

IMPORTANT! To provide electrical insulation and maintain electrical safety, a coating is applied to insulate the device except on the areas where the I/O ports are located.

Green ASUS notice

ASUS is devoted to creating environment-friendly products and packaging to safeguard consumers' health while minimizing the impact on the environment. The reduction of the number of the manual pages complies with the reduction of carbon emission.

For the detailed user manual and related information, refer to the user manual included in the ASUS Tablet or visit the ASUS Support Site at <http://support.asus.com/>.

ASUS Recycling/Takeback Services

ASUS recycling and takeback programs come from our commitment to the highest standards for protecting our environment. We believe in providing solutions for you to be able to responsibly recycle our products, batteries, other components as well as the packaging materials. Please go to <http://csr.asus.com/english/Takeback.htm> for detailed recycling information in different regions.

Model name: ASUS_X01AD (ZB633KL)

Manufacturer:	ASUSTeK Computer Inc.
Address:	4F, No.150, LI-TE RD., PEITOU, TAIPEI 112, TAIWAN
Authorised representative in Europe:	ASUS Computer GmbH
Address:	HARKORT STR. 21-23, 40880 RATINGEN, GERMANY

Index

A

- ASUS Phone 8
 - charging 11
 - microSD 9
 - nano SIM card 9
 - parts and features 8
 - turning on/off 13

B

- Backup and reset 26
- Block list 44
 - blocking 44
 - unblocking 44
- Bluetooth 52
 - enabling 52
 - pairing 53
 - unpairing 53

C

- Calculator 59
- Call logs 39
 - redial your last-called number 40
 - saving calls to Contacts 39
- Calls 37
 - answering 39
 - calling from Contacts 38
 - calling your favorite contacts 39
 - dialing a phone number 37
 - launching the Phone app 37
 - other call options 40
 - receiving 39
 - see also Contacts 41
 - see Call logs 39
 - see Extension number 37
 - see Multiple calls 40
 - see Smart Dialing 38
- Camera 48
 - camera home screen 48
 - launching 48
- Chrome 30
 - bookmarking pages 31
 - clearing the browser data 31
 - launching 30
 - sharing pages 31
- Clock 56
 - alarm clock 57
 - launching 56
 - stopwatch 57

- timer 58
- Contacts 41
 - adding 42
 - adding an extension number 42
 - contacts settings 41
 - customizing your contact's profile 43
 - see also Social networking 44
 - setting up your profile 41

D

- Date and time 23
 - setting up 23
- Dual SIM feature 35
 - assigning 36
 - renaming 35

E

- Extension number 37
 - auto dialing 38
 - confirmation prompt 37
 - dialing 37

F

- Face Unlock 27
- Favorite contacts 39
 - calling 39
 - marking 43
- Fingerprint 25
 - setting up fingerprint ID from Settings 26
 - starting your ASUS phone for the first time 25
 - locate finger print scanner 25
 - protect your phone 25

G

- Gmail 32
- Google Calendar 33
 - creating events 33
 - creating reminders 34
 - editing or removing events 33
 - editing or removing reminders 34
- Google Play Music 47
 - setting up your Google Play Music 47

H

- Headset 46
 - connecting 46
- Home screen 18
 - personalizing 21
 - see also Wallpapers 22

L

- Lock screen 24
 - customizing 24
 - see also Securing your ASUS phone 63

M

- Managing your call logs 39
 - redialing your last-called number 40
 - saving to Contacts 39

- Messages 45
 - replying to messages 45
 - sending messages 45

MicroSD 9

- Mobile network 51
 - enabling 51

- Multiple calls 40
 - answering another call 40

N

- Nano SIM cards 35
 - assigning a preferred nano SIM card 36
 - calls 36
 - cellular data 36
 - renaming 35
 - SMS messages 36

P

- Photos 49
 - deleting files 50
 - editing images 50
 - sharing files 49
 - viewing the photo location 49

Q

- Quick settings 19
 - adding features 19
 - removing features 19

R

- Ringtone 23
 - setting up 23
 - sound 23

S

- Security 63
- Smart Dialing 38
- Social networking 44
- Sound Recorder 60
 - launching Sound Recorder 60
 - pausing a recording 61
 - recording List 61
- Storage 62

- System 62
 - updating 62
- System notifications 20

T

- Tethering 54
 - Wi-Fi Hotspot 54
- Touchscreen 15
 - launching apps 15
 - moving or deleting items 15
 - moving through pages or screens 16
 - zooming in 16
 - zooming out 17

W

- Wallpapers 22
- Wi-Fi 51
 - connecting 52
 - disabling 52
 - enabling 51
 - see also Wi-Fi Hotspot tethering 54

Z

- ZenUI 7