

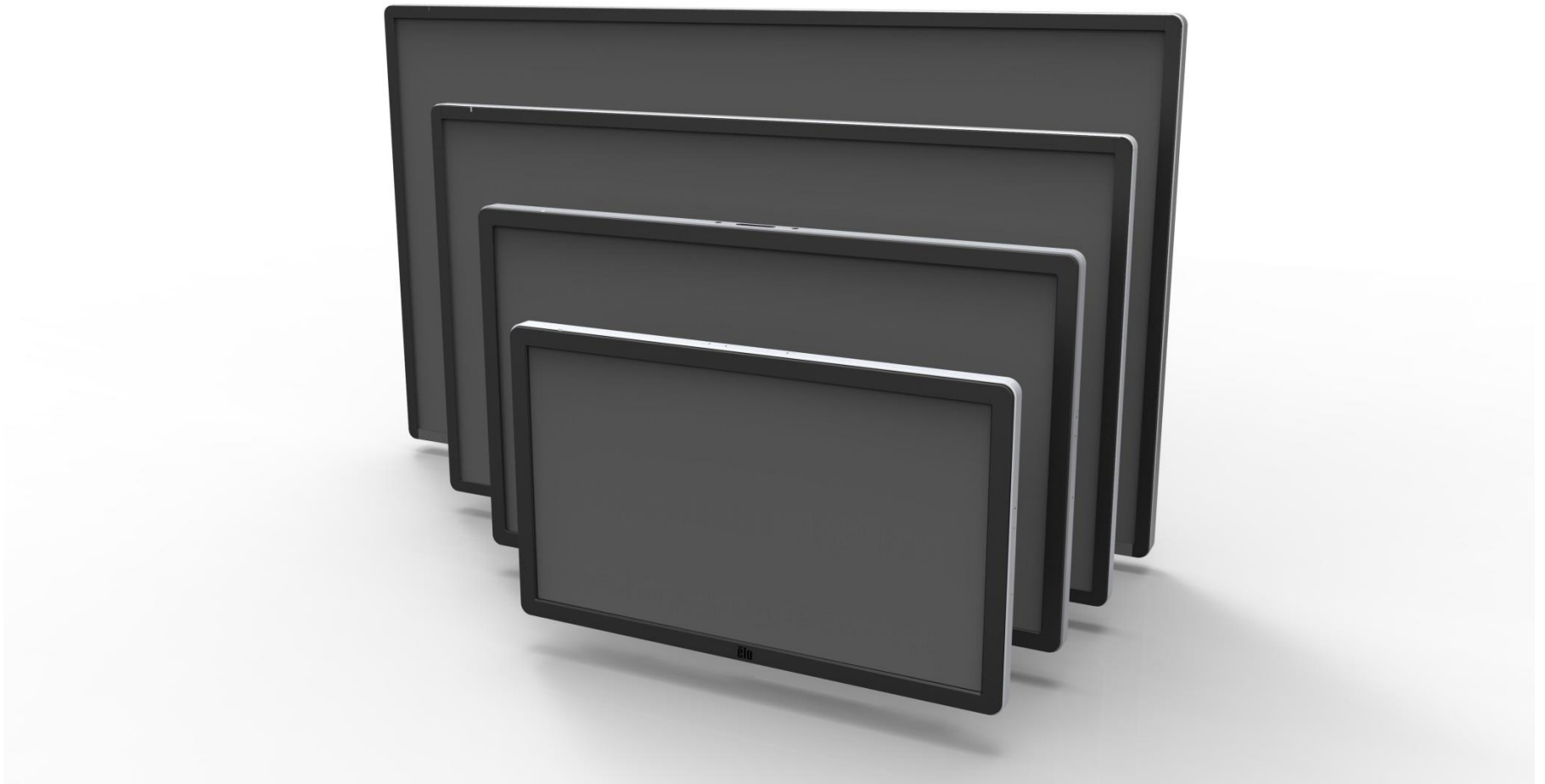

# USER MANUAL

---

## **Elo Touch Solutions** Interactive Digital Signage (IDS) 01-Series



No part of this publication may be reproduced, transmitted, transcribed, stored in a retrieval system, or translated into any language or computer language, in any form or by any means, including, but not limited to, electronic, magnetic, optical, chemical, manual, or otherwise without prior written permission of Elo Touch Solutions, Inc.

#### Disclaimer

The information in this document is subject to change without notice. Elo Touch Solutions, Inc. and its Affiliates (collectively “Elo”) makes no representations or warranties with respect to the contents herein, and specifically disclaims any implied warranties of merchantability or fitness for a particular purpose. Elo reserves the right to revise this publication and to make changes from time to time in the content hereof without obligation of Elo to notify any person of such revisions or changes.

#### Trademark Acknowledgments

AccuTouch, CarrollTouch, Elo, Elo (logo), Elo Touch, Elo Touch Solutions, Elo TouchSystems, IntelliTouch, iTouch, SecureTouch, TouchTools and VuPoint are trademarks of Elo and its Affiliates. Windows is a trademark of Microsoft Corporation.

# Table of Contents

Section 1: Introduction ..... 4

Section 2: Installation ..... 5

Section 3: Mounting ..... 10

Section 4: Operation ..... 14

Section 5: Technical Support ..... 27

Section 6: Safety & Maintenance ..... 29

Section 7: Regulatory Information..... 31

Section 8: Warranty Information..... 21

# Section 1: Introduction

## Product Description

Your new Interactive Digital Signage (IDS) touchmonitor combines Elo Touch Solutions reliable performance with the latest developments in touchscreen technology and display design. This combination of features creates a natural flow of information between a user and the touchmonitor.

This touchmonitor incorporates a 24-bit color, active matrix thin-film-transistor, and digital signage LCD panel to provide superior display performance. Its Full HD resolution of 1920x1080 is suitable for displaying graphics and images. Other features that enhance this LCD monitor's performance are Plug & Play compatibility, built-in speakers and headphone output capability, and a remote for on screen display (OSD) controls.

Computer modules designed specifically for this touchmonitor are available. These computer modules are designed to slide into a bay on the rear of the monitor and turn your IDS touchmonitor into an IDS All-in-One touchcomputer without affecting monitor form factor and without requiring extra cabling.

## Precautions

Follow all warnings, precautions and maintenance as recommended in this user manual to maximize the life of your unit and prevent risks to user safety. See Section 6 for more information on touchmonitor safety.

For your health and safety, it is strongly recommended that at least two people (four for the ET7001L/ET7001LT) handle, lift, and/or move these touchmonitors.

This manual contains information that is important for the proper setup and maintenance of the IDS and optional computer module. Before setting up and powering on your new touchmonitor and computer module, read through this manual, especially the Installation, Mounting, and Operation chapters.

# Section 2: Installation

## Unpacking the Interactive Digital Signage Touchmonitor

To unpack the IDS, follow these steps:

1. The carton should be oriented as prescribed by carton labeling.
2. Open and remove all 4 hinged plastic locks. There are 6 hinged plastic locks for the 7001L unit.

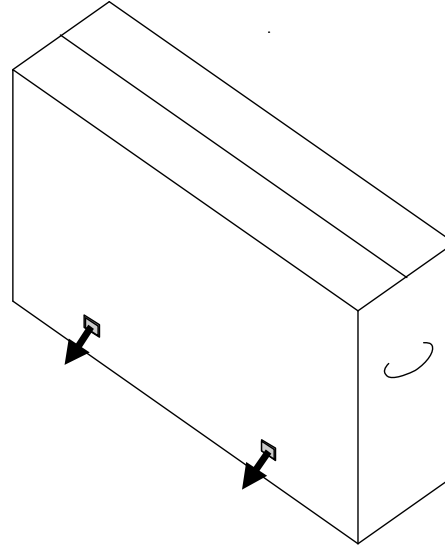

3. Once the locks are removed, lift the cartons top lid off the bottom frame.

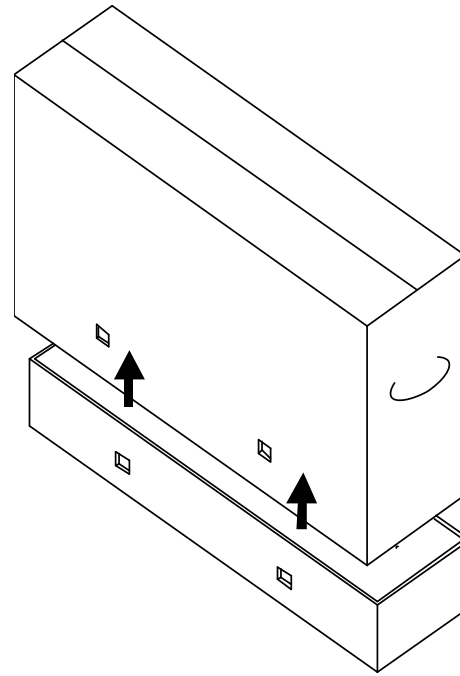

4. With the top lid removed, you now have access to the IDS touchmonitor and accessories that came with the touchmonitor. Open the carton and verify that the following items are present:

- IDS Monitor with protective film for its face
- Quick Install Guide
- User Manuals CD (not included in all models. Latest version of user guide is available at [www.elotouch.com](http://www.elotouch.com))
- North America power, Europe/Korea power, U.K. power, Argentina power, Taiwan power, China power, Korea power, Japan power, & Japan 3pin-2pin adapter
- HDMI Cable
- USB Cable
- Japanese language regulatory information pamphlet
- RS-232 (5551L only)
- VGA cable for the Y-Cable (7001LT/5501LT). The Y-Cable is used to send MDC to the monitor. For more information about MDC commands, see Section 4.

# Connector Panel & Interfaces

Remove the cable cover on the bottom rear (when viewed in landscape orientation) to access the touchmonitors connector panel.

Image of IDS01 monitor back I/O ports with OSD remote

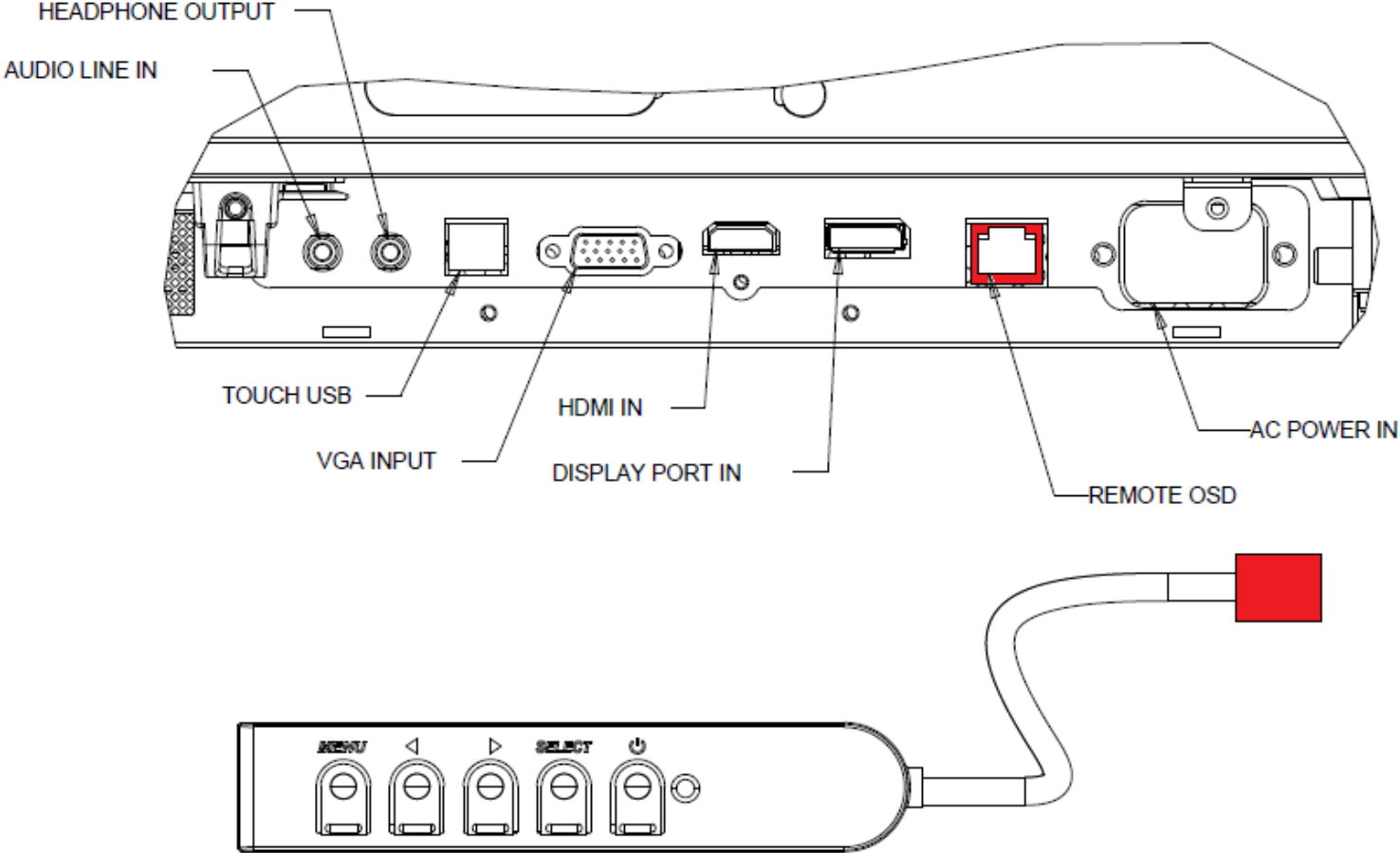

## Image of IDS5551 monitor back I/O ports with OSD remote

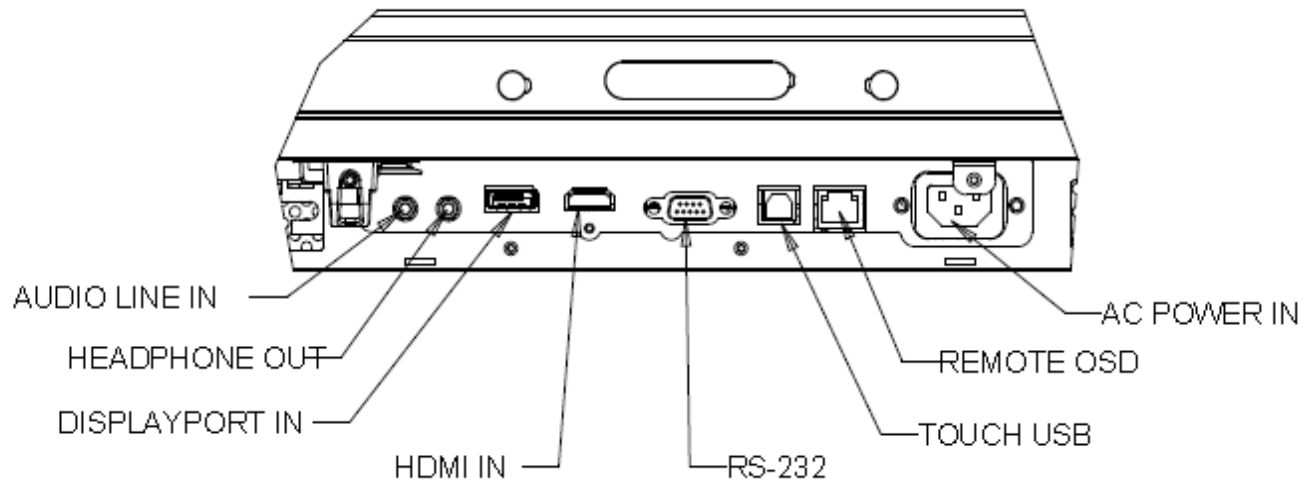

## IDS Touchmonitor Connections to an External Computer

1. Connect the HDMI cable between the monitor and the video source.
2. Connect the USB touch cable between the monitor and the PC.
3. Select the correct power cable for your region. Connect it between the AC power source and the touchmonitors POWER IN connector.
4. The touchmonitor ships in an ON state. Use the remote OSD to access the On Screen Display Menu.



## Installing the Touch Technology Software Drivers

The Elo touch driver and the Elo Computer Module driver packs are available with the CD that ships with the touchmonitor and also at [www.elotouch.com](http://www.elotouch.com).

Visit the Elo Touch Solutions website [www.elotouch.com](http://www.elotouch.com) for:

- Updates to the Elo touch driver
- Additional touch driver information
- Detailed touch driver installation guides
- Touch drivers for other operating systems

To download latest touch drivers:

1. Visit [www.elotouch.com/Support/Downloads/Driver/DriverDownload/Default.aspx](http://www.elotouch.com/Support/Downloads/Driver/DriverDownload/Default.aspx)
2. Select the operating system from “Operating System” dropdown menu.
3. Select the technology from “Technologies” dropdown menu.
4. Click on the driver version required for your touchmonitor.
5. Click “Accept” once you are directed to the “Driver License Agreement” page.
6. Enter your email address, Click on “Next Step”. Your driver download will start automatically.
7. If you are a new user, fill in the required information and Click on “Register”. Your driver download will start automatically.

IntelliTouch Plus units are HID compatible, but will require the Elo driver if touch calibration is required.

Optical units and Infrared are HID compatible and do not require an Elo touch driver. If an Elo touch driver has previously been installed on the host computer, remove this driver by opening Control Panel and selecting to remove the driver completely.

## Section 3: Mounting

**Note:** For your health and safety, it is strongly recommended that at least two people (four are recommended for the ET7001L/ET7001LT) handle, lift, or move these touchmonitors.

**Note:** Do NOT lay the display face-down as this can cause damage to the monitor.

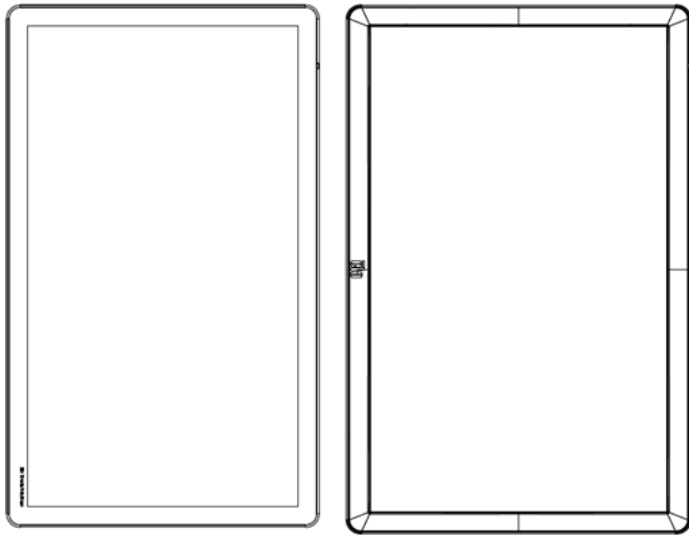

### Portrait Mode

When rotating the monitor to portrait mode, ensure it is done such that the Elo logo is oriented according to the pictures presented here.

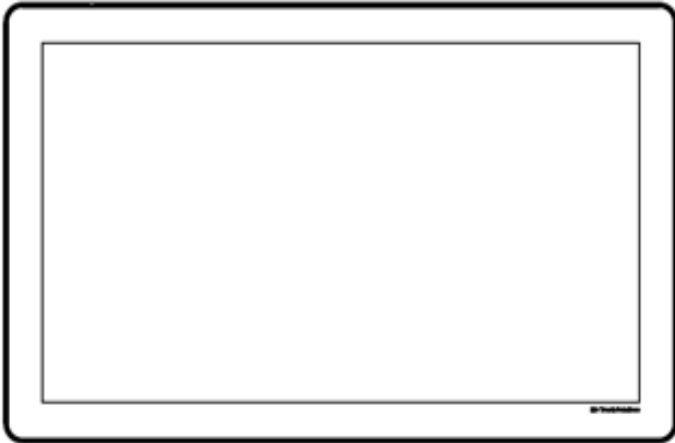

## Landscape Mode

When rotating the monitor to landscape mode, ensure it is done such that the Elo logo is oriented according to the pictures presented here.

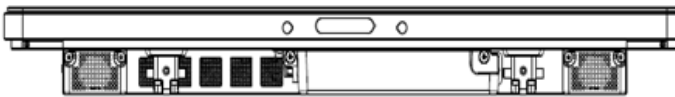
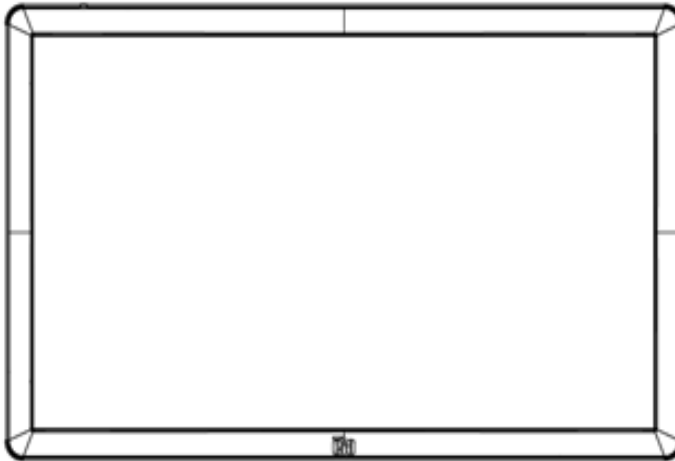

## Table Top Mode'

Table Top –Refer to the Temperature Control section for table top mode requirements.

## Rear VESA Mount

For the 32" and 42" models:

A four-hole, 400x400mm mounting pattern is provided on the rear of the monitor.

The VESA FDMI-compliant mounting is coded: VESA MOUNT PER MIS-F, 400,400,6MM

For the 55" models:

A four-hole, 600x600mm mounting pattern is provided on the rear of the monitor.

The VESA FDMI-compliant mounting is coded: VESA MOUNT PER MIS-F, 600,600,6MM

For the 70" models:

A four-hole, 400x400mm mounting pattern is provided on the rear of the monitor.

The VESA FDMI-compliant mounting is coded: VESA MOUNT PER MIS-F, 400,400,8MM

For the 7001LT" models:

A four-hole, 600x600mm mounting pattern is provided on the rear of the monitor.

The VESA FDMI-compliant mounting is coded: VESA MOUNT PER MIS-F, 600,600,8MM

Go to [www.elotouch.com](http://www.elotouch.com) for dimensional drawings.

## Optional Stand (for 3201L and 4201L Only) Elo PN: E455084

**Optional Wall Mounts Kits (detailed information available on the MS drawing for each size)**

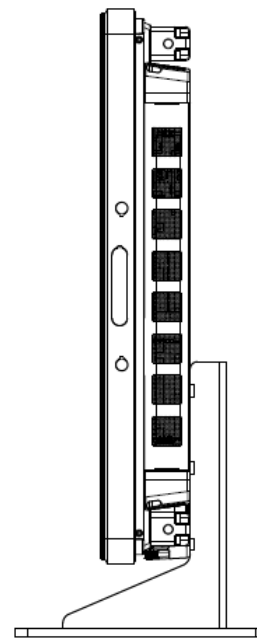
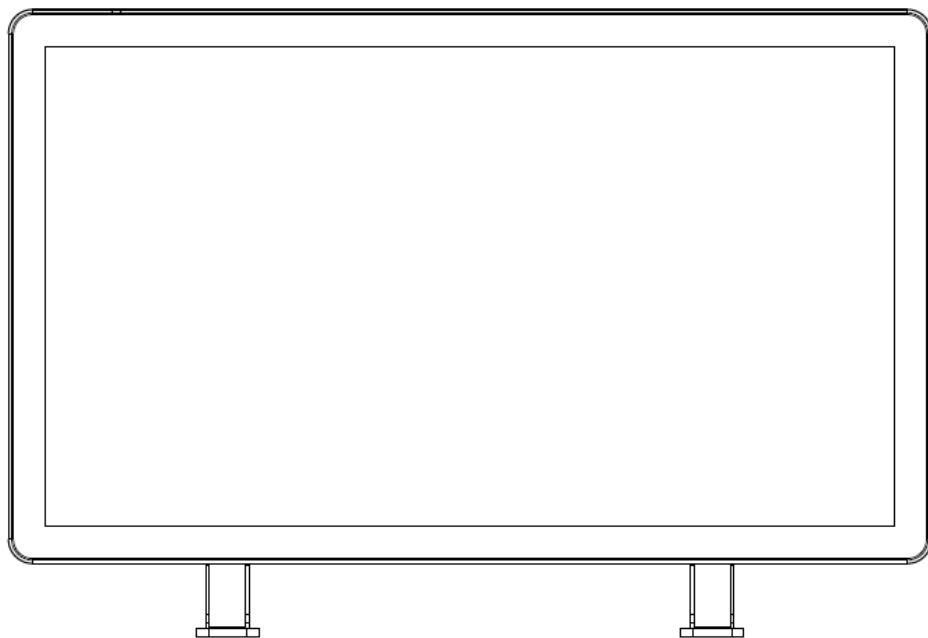

Refer to the wall mount user guide for detailed information. Wall mount user guide is available from [www.elotouch.com](http://www.elotouch.com), from Support page of each IDS touchmonitor product page.

# Section 4: Operation

## Power

To turn the touchmonitor on or off, press the touchmonitor power button once. If a computer module is installed, then the computer module will also turn on with the monitor.

To abruptly power off the computer module and touchmonitor, press and hold the touchmonitor power button until the computer shuts off.

To gracefully shut down the computer module, follow the computer modules operating systems normal power off procedure.

Power Status LED on the OSD Remote functions according to the following table:

TouchMonitor/Computer Module Status	LED Status
OFF	OFF
SLEEP	PULSING
ON	ON

The system consumes low power when in SLEEP and OFF modes. For detailed power consumption specifications, refer to technical specifications on the Elo website <http://www.elotouch.com>

Touching the screen will bring the attached host PC out of SLEEP mode (similar to moving the mouse or pressing a keyboard key).

To improve reliability and reduce wasteful power consumption, disconnect the AC power cable from the monitor when long periods of disuse are planned.

The maximum voltage, frequency and current for this touchmonitor is provided in the power ratings table below:

	Operating Voltage Range	Operating Frequency Range	Operating Current Range
ET3201L/ET4201L	100 - 240Vac	50/60 Hz	3.6 – 1.5 A
ET5501L/ET5501LT/ET5551LT	100 - 240Vac	50/60 Hz	5 – 2.1 A
ET7001L/ET7001LT	100 - 240Vac	50/60 Hz	5 – 2.1 A

To keep the product operating at an optimum level please limit the product usage cycle to 18 hours for every 24 hours:

## Usage duty cycle

18 hours on per 24 hours

Elo recommends using the Content Management System or O/S scheduling settings and/or EloView commands to manage duty cycle. This will promote power savings and troublefree operation throughout the life of the monitor.

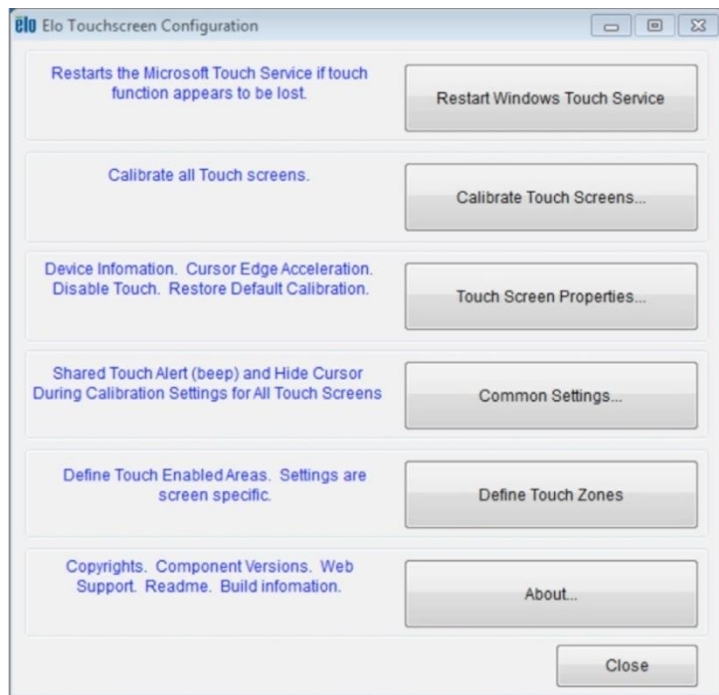

## IntelliTouch Plus Touchscreen Technology

When connected to Windows 7 computers, the touchmonitor can report 2 simultaneous touches. When connected to Windows XP computers, the touchmonitor reports single touch.

The IntelliTouch Plus touchscreen can be re-calibrated to your displayed video image, if needed. Calibration can be done through the Elo driver control panel.

The IntelliTouch Plus driver will only support multiple monitors if they are all using the IntelliTouch Plus touch technology.

To use multiple IntelliTouch Plus monitors, double click on the EloConfig desktop shortcut to open up the Elo Touchscreen Configuration screen



Select "Match Touch to Display..." to calibrate multiple monitors.

## Optical Touchscreens Technology

When connected to Windows 7 or Win 8.1 computers, the touchmonitor can report six simultaneous touches.

## InfraRed (IR) Touchscreens Technology

When connected to Windows 7 or Windows 8.1 computer, the touchmonitor can report ten simultaneous touches.

## Projective Capacitance Touchscreens Technology

When connected to Windows 7 or 8 computers, the touchmonitor can report 10 simultaneous touches.

No additional drivers are required for this technology to work, it uses Windows HID drivers.

Refer to Section 2, "Installing the Touch Technology Software Drivers" to find instructions to download touch drivers for Windows XP. No calibration is required for this technology.



## Gesture Support

The IntelliTouch Plus touch technology enables several gestures that support single and multiple touches. Refer to the Microsoft Website <http://msdn.microsoft.com/en-us/library/dd940543> on the various gestures that are supported in Windows 7.

## Video

A display's native resolution is its width and height measured in number of pixels. Generally, for best performance, an image displayed on this monitor will look best when your computer's output resolution matches this monitor's native resolution.

For computer output resolutions at non-native resolutions, the monitor will scale the video to its panel's native resolution. This involves stretching or compressing the input image as needed in the X- and Y-dimensions to fit the display's native resolution. An unavoidable byproduct of the scaling algorithms is a loss of fidelity when the computer's output video image is scaled by the monitor to fit the display. This loss of fidelity is most apparent when viewing feature-rich images at close distances (for example images containing small-font text).

Your touchmonitor will likely not require video adjustments. However, for analog VGA video, variations in video graphic card outputs may require user adjustments through the OSD to optimize the quality of the touchmonitor's displayed image. These adjustments are "remembered" by the touchmonitor. Also, to reduce the need for adjustments for different video mode timings, the monitor correctly scales and displays some of the video industry's most common video timing modes. Refer to the technical specifications for this monitor at <http://www.elotouch.com> for a list of these Preset Video Modes.

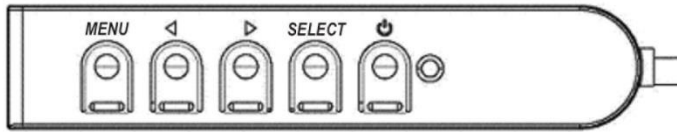

## On-Screen Display (OSD)

Four OSD buttons are located on a wired control box. These can be used to adjust various display parameters. The buttons and their functionality are defined as follows:

Button	Function when OSD is not displayed	Function when OSD is displayed
Menu	Display OSD main menu	Return to previous OSD menu
◀	Display OSD Audio source submenu	Decrease value of selected parameter / select previous menu item
▶	Hot key for changing video source*	Increase value of selected parameter / select next menu item
Select	Display Audio and Video Parameters Menu	Select parameter for adjustment / select submenu to enter

\*The hot key allows the user to quickly change the input video source. If the user accidentally presses this key, they can quickly press the Menu button to cancel a video source change.

Using the OSD buttons controls an on-screen graphical user interface which displays on top of your input video, allowing intuitive adjustment of the following display parameters:

Parameter	Available Adjustment
Main Menu	Video Settings, Audio Settings, Color Settings and Other Settings can be selected
Video Settings	Video Source, Brightness, Contrast, Black Level, Sharpness and Aspect Ratio are available in this menu.
Video Source	Allows the user to switch between the available video sources.
Audio Settings	Allows the user to toggle the mute setting. Also, the volume of the internal speakers or headphones can be adjusted.
Color Settings	Displays the Color Adjust and Color Preference Menus
HDMI	Allows HDMI video to be displayed on the monitor
VGA Port	Allows VGA video to be displayed on the monitor
DisplayPort	Allows DisplayPort video to be displayed on the monitor
Elo Computer Module	ECM DP – DisplayPort is the standard video output of Elo Computer modules. If HDMI video input is found, the video source can be switched.
Video Source	<p>The monitor continually scans for active video from VGA, DisplayPort, HDMI, and the Computer Module. This adjustment selects which of those input ports should be displayed.</p> <p>If an Elo Computer Module or Intel OPS computer module has been detected, video priority is given to the computer module before any of the external sources.</p>

Parameter	Available Adjustment
Brightness	Increase/decrease monitor brightness. Default: 65
Contrast	Increase/decrease monitor contrast. Default: 50
VGA Settings	Allows user to change the H. position, V. position, Clock and Phase. If VGA is selected, the Auto-Adjust feature is available.
Sharpness	Adjusts sharpness of the displayed images. Default: no sharpness adjustment Sharpness function is disabled when the input source ratio is the same as the panels native ratio
Aspect Ratio	Switches the scaling method between Fill Screen and Fill to Aspect Ratio.
Light Sensor	The light sensor can be toggled on or off. When the light sensor is enabled, the brightness cannot be changed manually.
Auto Adjust	Automatically adjusts the system clock to the input analog VGA video signal, affecting the H-position, V-position, Clock, and Phase menu items. Not applicable when using HDMI video or the Computer Module.
Clock	Allows fine adjustments of the panel pixel dot clock. Not applicable when using HDMI/DisplayPort video or the Computer Module.
Phase	Allows fine adjustments of the panel pixel dot clock phase. Not applicable when using HDMI/DisplayPort video or the Computer Module.

Parameter	Available Adjustment
H-position	<p>Moves the image horizontally on the display in single-pixel increments.</p> <p>Default: centered.</p> <p>Not applicable when using HDMI/DisplayPort video or the Computer Module.</p>
V-position	<p>Moves the image vertically on the display in single-pixel increments.</p> <p>Default: centered.</p> <p>Not applicable when using HDMI/DisplayPort video or the Computer Module.</p>
Black Level	<p>The user can choose between Standard, 5%, 10% or 15% black level offset.</p>
Color Temperature	<p>Selects the displays color temperature. The available color temperatures are 9300K, 7500K, 6500K, 5500K, and User Defined. If the User Defined option is selected, the user can change the color temperature by changing individual R, G, and B gains on a scale from 0 to 100.</p> <p>Default: User Defined with R, G, and B all set to 100.</p>
Audio Source	<p>Allows the user to choose the audio source. The choices are From Video Source, Line in and ECM Line-in (available only if an ECM is detected)</p> <p>If there is no Computer Module plugged in, and the video source is HDMI, the options are: Line In and HDMI.</p> <p>Default: Line In.</p>
Color Adjust	<p>The Color Temperature menu can be chosen or Hue and Saturation can be varied in this menu.</p> <p>Color Temperature will only be available in the Standard color preference mode. Hue and Saturation are available in the remaining color preferences.</p>

Parameter	Available Adjustment
Color Preference	<p>Standard, Movie, Gaming, Photo, Line or Legacy HDMI can be chosen depending on the users preference.</p> <p>Standard Mode: Color and Sharpness are set at an optimal level in this mode. Recommended for use when displaying high quality images and video. This is the default mode.</p> <p>Movie, Gaming and Photo Modes: Allow the user to vary the Hue and Saturation depending on application.</p>
Other Settings	<p>OSD menu: The Horizontal position, vertical position and OSD timer can be changed from here.</p> <p>Language Settings can be changed</p> <p>Recall Defaults: set the system back to the preset standards</p>
OSD Timer	<p>Adjusts how long a period of OSD button inactivity the Touchmonitor will wait before closing the OSD. The adjustable range is between 5 and 60 seconds.</p>
OSD Language	<p>Selects which language the OSD information is displayed in. The available languages are: English, French, Italian, German, Spanish, Simplified Chinese, Traditional Chinese, and Japanese.</p> <p>Default: English.</p>
OSD H-Position	<p>Moves the OSD location left and right on the display.</p> <p>Default: 50 (centered)</p>
OSD V-position	<p>Moves the OSD location up and down on the display.</p> <p>Default: 50 (centered)</p>
Recalling Defaults	<p>Selecting "Recall Defaults" restores all factory default settings for OSD-adjustable parameters (except OSD Language and OSD Position) and for Preset Video Mode timings.</p>
Power Behavior	<p>When power to the monitor is lost and regained, the behavior that is chosen will be executed.</p>
MDC Protocol	<p>This menu allows the user to switch between the serial protocol and the DDC/CI protocol.</p>
Tabletop	<p>Enables or disables the Tabletop Thermal Protection Mode settings</p>

Parameter	Available Adjustment
Information	Displays Monitor Information, System Temperature and Help & Support options. Nothing is adjustable in this menu.
Monitor Information	Displays the touchmonitor model and the monitor and touchscreen serial # information
System Temperature	Displays the real-time temperature of the Video Board Note: Docking Board and the CPU Sensor temperatures are only available if these features are supported by the computer module.
Help & Support	Display information regarding Elo Touch Solutions contact information.

All touchmonitor adjustments made through the OSD are automatically memorized as soon as they are entered.

This feature saves you from having to reset your choices every time the touchmonitor is unplugged or powered off and on. If there is a power failure, the touchmonitor settings will not default to the factory specifications.

## OSD and Power Lockouts

Press and hold the “Menu” and “Down” buttons for two seconds to enable/disable the OSD Locking feature. When the OSD Locking is enabled, pressing any of the “Menu”, “Up”, “Down”, or “Select” buttons will have no effect on the system.

Press and hold the “Menu” and “Up” buttons for two seconds to enable/disable the Power Locking feature. When the Power Locking is enabled, pressing the power switch will have no effect on the system.

## Audio

Audio from the touchmonitor Line In, touchmonitor HDMI, touchmonitor DisplayPort, computer module Line In, or computer module HDMI or DisplayPort ports can be played over the touchmonitors internal speakers. See the “Audio Source” OSD parameter for details. When headphones are plugged into the headphone output jack, the internal speakers turn off and audio is played over the headphones.

Volume and muting of the speaker and headphone outputs can be controlled by the OSD.

## MDC Functionality (For Remote Monitor Applications)

The touchmonitor has the ability to allow remote access from a host application. This is done through the use of the Multiple Display Control command sets. By installing the IDS Utilities Suite, the user can communicate with the monitor via the application. The host application can send a variety of different instructions which will be executed on the IDS 01 series touchmonitor. For detailed information regarding the command set, refer to the application note available [here](#).

A Y-Cable is included in the 7001LT which allows users to send serial commands via the VGA port of the monitor. One connector of this cable is for the VGA video signal and the other connector is for the RS232 signal (MDC).



## RFID Functionality

For 3201L and 4201L Units:

There is an integrated RFID antenna within the monitor. To enable the RFID functionality, a RFID reader module (available at [www.elotouch.com](http://www.elotouch.com)) must be installed and connected to the integrated monitor antenna. Refer to the RFID peripheral installation guide for proper hardware and software installation techniques.

For the 5501L/5501LT and 7001L/7001LT units, an external peripheral kit is available from Elo.

The list of RFID protocols that are supported and can be read are:

- ISO-14443-A
- ISO-14443-B
- ISO-15693

The RFID features Peer-to-Peer applications and the Read and Write functionality.

The location of the RFID antenna is indicated by the arrow in the following location. RFID tags can be read at a distance of up to 40 mm away from the bezel.



For best results, touch the tag directly to the bezel area containing the antenna.

# Driver Installation

Elo Computer Modules (ECMG2B-i3, i5, and i7) that comes with Windows operating systems preinstalled have all required drivers preloaded.

All required drivers are available online at [www.elotouch.com](http://www.elotouch.com).

For No Operating System (OS) units, the drivers are provided on the accompanying driver CD and are available online at [www.elotouch.com](http://www.elotouch.com).

## For Windows Operating Systems

After the computer finishes booting up, follow these instructions to install the drivers:

- Attach the external CD-Rom drive to the monitor and turn the computer on
- Insert the drivers CD
- After the OS has booted, right click on “My Computer”
- Click on Manage
- Click on Device Manager
- Highlight one of the devices that has a warning label and click “Update Driver”
- Click the option “Browse My Computer for Driver Software”
- Choose the path to your CD-Rom drive and click “Next”
- Let the device software component be installed and then proceed to the next device.
- Do this for all of the devices that have the warning label.

## For Mac OS X or higher

These drivers are automatically installed when the system is connected to the monitor. To find information on the drivers:

- Open the Terminal window and under Hardware select USB. A screen that looks like the image below will appear. The available USB devices will be displayed.

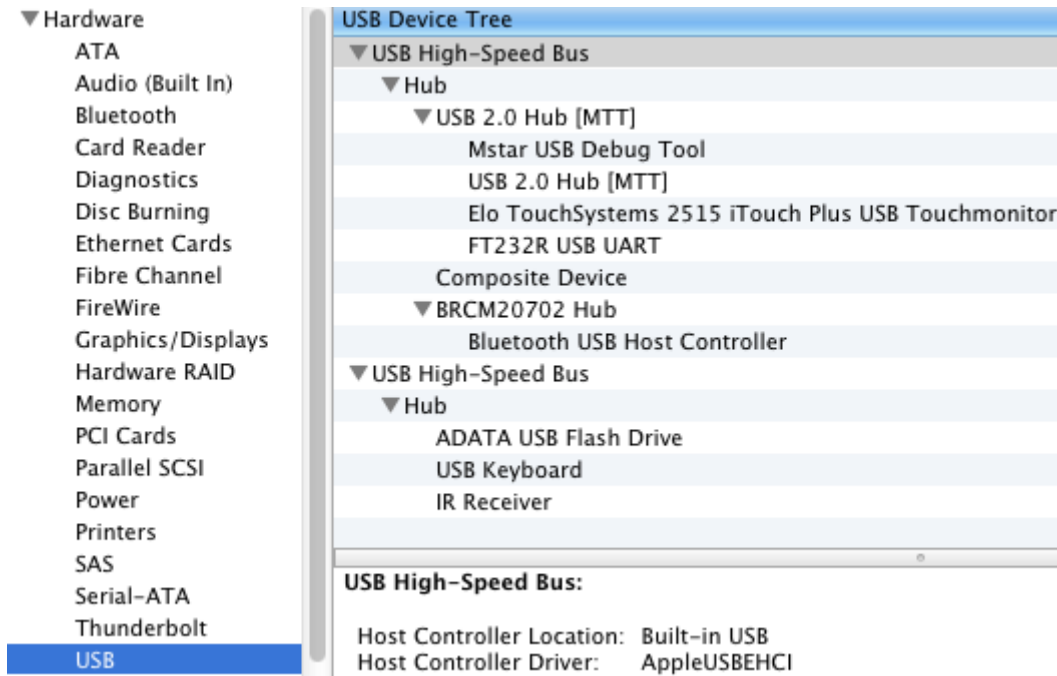

NOTE: The Elo Touch Solutions Touchmonitor ID will be different according to the monitor touch technology.

## For Ubuntu versions that support touch:

These drivers are automatically installed when the system is connected to the monitor. To find information on the drivers:

- Open a Terminal window and type “lsusb” as the command. A screen that looks like below will open. The available USB devices will be displayed.

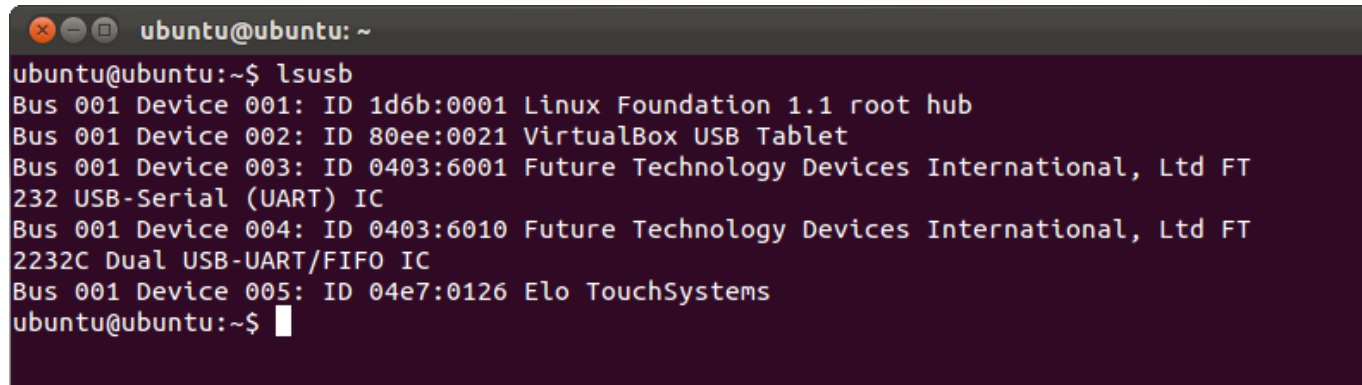
A terminal window with a dark background and light text. The title bar shows 'ubuntu@ubuntu: ~'. The prompt is 'ubuntu@ubuntu:~\$'. The command 'lsusb' has been entered and executed. The output lists five USB devices connected to the system.

```
ubuntu@ubuntu:~$ lsusb
Bus 001 Device 001: ID 1d6b:0001 Linux Foundation 1.1 root hub
Bus 001 Device 002: ID 80ee:0021 VirtualBox USB Tablet
Bus 001 Device 003: ID 0403:6001 Future Technology Devices International, Ltd FT
232 USB-Serial (UART) IC
Bus 001 Device 004: ID 0403:6010 Future Technology Devices International, Ltd FT
2232C Dual USB-UART/FIFO IC
Bus 001 Device 005: ID 04e7:0126 Elo TouchSystems
ubuntu@ubuntu:~$
```

## Temperature Control

The IDS 01 Series monitors contain a temperature sensor that provides the user with real-time temperature readings. This reading can be found on the OSD menu by clicking on: Other Menu ► Information ► System Temperature. If the monitor senses temperatures higher than the operating range, the monitor will go into “Thermal Protection Mode.” This mode allows the monitor to remain operational during brief periods of use outside of its operating range.



**Example of OSD showing the Video Board Temperature**

In Thermal Protection Mode, the monitor will reduce the backlight brightness to bring the internal temperature back within operating range. While in this mode, brightness cannot be increased. If the internal temperature decreases below the Thermal Protection Mode temperature for at least five minutes, normal operation is resumed. The OSD temperature at which the monitor will enter the Thermal Protection Mode is in the table below.

When the Thermal Protection Mode is enabled, the following icon will appear in the Main Menu and the Brightness Menu. This will indicate that the Thermal Protection Mode is active.

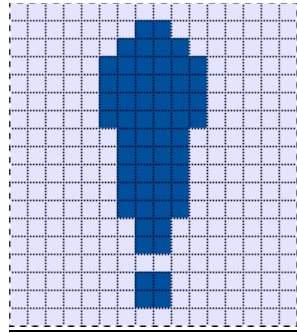

**Icon showing that Thermal Protection Mode is active**

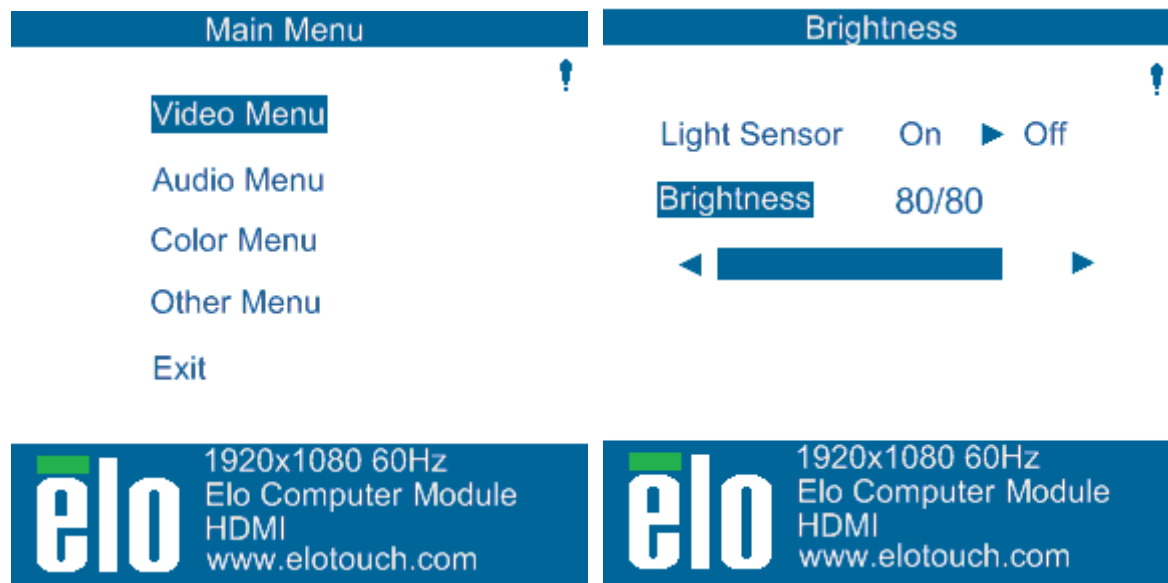

**Thermal Protection Mode icon will show on the top corner of these menus indicating that the Thermal Protect Mode is active**

The user will be prompted to shut off the monitor within sixty seconds if the temperature continues to rise after Thermal Protection Mode Step 2 has been enabled. If the system is not manually turned off in sixty seconds, the touchmonitor will automatically turn off to prevent permanent damage to the monitor. The table below shows the Auto Shut Off temperature.

Note: Thermal protection mode becomes enabled when the monitor is operating at extreme ambient conditions.

## Portrait and Landscape Mode

Monitor Size	Thermal Protection Mode Step 1 (°C)	Thermal Protection Mode Step 2 (°C)	Auto Shut Off Temperature (°C)
ET3201L/4201L	60	65	70
ET5501L/ET5501LT	56	61	65
ET5551L	57	62	67
ET7001L/ET7001LT	50	55	63

In the event that Thermal Protection Mode Step 1 is reached and enabled, the monitor will resume full operational capabilities only after the OSD temperature decreases to the values set forth in the table below. These temperatures must be retained for at least five minutes.

Monitor Size	Thermal Protection Mode Step 1 Disabled (°C)
ET3201L/4201L	55
ET5501L/ET5501LT	53
ET5551L	54
ET7001L/ET7001LT	45

If Thermal Protection Mode Step 2 is reached, the internal temperature needs to first decrease back to or below the Step 1 temperature for five minutes to enter back to Thermal Protection Mode Step 1.

Example of Thermal Protection Mode for an ET4201L Monitor with 100% Brightness:

At Step 1: When OSD Temperature reaches 60°C, Brightness gets automatically set to 80%

Normal operation returns if OSD temperature is maintained at 55°C or lower temperature for five minutes.

At Step 2: When OSD Temperature reaches 65°C, Brightness gets automatically set to 72%

Return to Step 1 if OSD temperature is maintained at 60°C or lower temperature for five minutes.

If the monitors internal temperature continues to rise, the monitor will shut off at OSD = 70°C

## Table Top Mode

Requirements:

1. The Table Top Mode function on the OSD must be enabled if the unit is placed in table top orientation.
2. Cooling methods must be put in place to ensure that the air temperature beneath the monitor does not exceed the operating specifications. Consult chapter 7 for operating temperature specifications.

**Note: The warranty will be void if failure occurs to the monitor in table top mode orientation and the Table Top Mode function is not enabled without adequate cooling methods installed.**

When the monitor is in Table top mode, the Thermal Protection steps are different. These OSD values are stated in the table below.

Monitor Size	Thermal Protection Mode Enabled Step 1 (°C)	Thermal Protection Mode Enabled Step 2 (°C)	Thermal Protection Mode Enabled Step 3 (°C)	Auto Shut Off Temperature (°C)
ET3201L/4201L	60	65	70	75
ET5501L/ET5501LT	57	61	n/a	65
ET5551L	59	64	n/a	68
ET7001L/ET7001LT	59	64	69	74

## Intelligent Brightness Control

The IDS 01 touchmonitors include a light sensor that adjusts the brightness of the screen in accordance with the ambient light level surrounding the monitor.

Note: When the Thermal Protection Mode is activated, the Intelligent Brightness Control feature will act within the limits set forth in the Temperature Control section.

## Video Firmware Upgrade

The IDS 01 series touchmonitors allows for updating the video firmware using an external computer. Contact Elo customer service for information on how to upgrade the video firmware.



# Section 5: Technical Support

If you are experiencing trouble with your touchmonitor, refer to the following suggestions.

If the problem persists, please contact your local dealer or contact Elo Touch Solutions Customer Service.

Worldwide technical support phone numbers are available on the last page of this use manual.

## Solutions to Common Problems

Problem	Suggested Troubleshooting
The touchmonitor does not respond when turning on the system	Check that the AC power cable is properly connected Verify the AC power source is functioning.
Monitor display is dim	Use the OSD to increase the brightness Use the OSD to increase the contrast
Monitor display is blank	If the Power Status LED is blinking, the monitor or Computer Module may be in SLEEP mode Press any key / move the mouse / touch the touchscreen to see if the image reappears Check that the signal source device is turned on Check that that there are no loose cable connections
Monitor displays an "Out Of Range" message	Adjust your computer's resolution/timing mode to be within the allowable timing ranges specified for your touchmonitor (see website for specifications)
Monitor display image looks strange	Adjust your computer's resolution/timing mode to be within the allowable timing ranges specified for your touchmonitor (see website for specifications) Use the Auto Adjust function in the OSD
Touch functionality doesn't work	Verify your PC has the latest Elo drivers installed Perform the calibration routine provided with the latest Elo drivers
The OSD buttons or power button does not respond when pressed	Check to see if the OSD lock or power lock functions are on
Can't wake on touch	Check to see if the OSD touch on sleep function is disabled
The Computer Module does not respond when turning on the system.	Disconnect the AC power cable and verify that the Computer Module is properly installed. Reconnect the AC power cable.

## Technical Assistance

### Technical Specifications

visit [www.elotouch.com/products](http://www.elotouch.com/products)  
for technical specifications for this device

### Online Self-Help

visit [www.elotouch.com/go/websupport](http://www.elotouch.com/go/websupport)  
for online self-help

### Technical Support

visit [www.elotouch.com/go/contactsupport](http://www.elotouch.com/go/contactsupport)  
for technical support

See this user manual's last page for worldwide technical support phone numbers.

# Section 6: Safety & Maintenance

## Safety

- To avoid risk of electric shock, follow all safety notices and do not disassemble the touchmonitor. They are not user-serviceable.
- The slots located on the sides and top of the touchmonitor case are for ventilation. Do not block or insert anything inside the ventilation slots.
- The touchmonitor ships with a 3-wire, grounding power cord. The power cord plug only fits into a grounded outlet. Do not fit or modify the plug into an outlet that has not been configured for this purpose. Do not use a damaged power cord. Only use the power cord that came with your ELO touchmonitor. Use of an unauthorized power cord may invalidate touchmonitor warranty.
- Ensure that your installation allows touchmonitor to meet specified environmental conditions listed in Section 7.

## Care and Handling

The following tips will help keep your touchmonitor functioning at an optimal level:

- Disconnect the AC power cable before cleaning.
- To clean the display unit cabinet, use a clean cloth lightly dampened with a mild detergent.
- It is important that your unit remains dry. Do not get liquids on or inside the unit. If liquid does get inside, turn the unit off and have a qualified service technician check it before you power it on again.
- Do not wipe the screen with a cloth or sponge that could scratch the surface.
- To clean the touchscreen, use window or glass cleaner applied to a clean cloth or sponge. Never apply the cleaner directly to the touchscreen. Do not use alcohol (methyl, ethyl or isopropyl), thinner, benzene, or other abrasive cleaners.
- Ensure the environmental conditions (i.e. temperature and humidity) are maintained within specification and do not block ventilation slots.
- Monitors are not designed for outdoor use.

## Waste Electrical & Electronic Equipment Directive (WEEE)



This product should not be disposed of with household waste. It should be deposited at a facility that enables recovery and recycling.



Elo has put in place recycling arrangements in certain parts of the world. For information on how you can access these arrangements, please visit [www.elotouch.com/e-waste-recycling-program/](http://www.elotouch.com/e-waste-recycling-program/).

# Section 7: Regulatory Information

## Electrical Safety Information

Compliance is required with respect to the voltage, frequency, and current requirements indicated on the manufacturer's label. Connection to a different power source than those specified herein will likely result in improper operation, damage to the equipment or pose a fire hazard if the limitations are not followed.

There are no operator serviceable parts inside this equipment. There are hazardous voltages generated by this equipment which constitute a safety hazard. Service should be provided only by a qualified service technician.

Contact a qualified electrician or the manufacturer if there are questions about the installation prior to connecting the equipment to mains power.

## Emissions and Immunity Information

Notice to Users in the United States: This equipment has been tested and found to comply with the limits for a Class A digital device, pursuant to Part 15 of FCC Rules. These limits are designed to provide reasonable protection against harmful interference in a residential installation. This equipment generates, uses, and can radiate radio frequency energy, and if not installed and used in accordance with the instructions, may cause harmful interference to radio communications.

Notice to Users in Canada: This equipment complies with the Class A limits for radio noise emissions from digital apparatus as established by the Radio Interference Regulations of Industrial Canada.

Notice to Users in the European Union: Use only the provided power cords and interconnecting cabling provided with the equipment. Substitution of provided cords and cabling may compromise electrical safety or CE Mark Certification for emissions or immunity as required by the following standards:

This Information Technology Equipment (ITE) is required to have a CE Mark on the Manufacturer's label which means that the equipment has been tested to the following Directives and Standards: This equipment has been tested to the requirements for the CE Mark as required by EMC Directive 2014/30/ EU as indicated in European Standard EN 55032 Class A and the Low Voltage Directive 2014/35/EU as indicated in European Standard EN 60950-1.

General Information to all Users: This equipment generates, uses and can radiate radio frequency energy. If not

installed and used according to this manual the equipment may cause interference with radio and television communications. There is, however, no guarantee that interference will not occur in any particular installation due to site-specific factors.

1. In order to meet emission and immunity requirements, the user must observe the following:
  - a. Use only the provided I/O cables to connect this digital device with any computer.
  - b. To ensure compliance, use only the provided manufacturer's approved line cord.
  - c. The user is cautioned that changes or modifications to the equipment not expressly approved by the party responsible for compliance could void the user's authority to operate the equipment.
  
2. If this equipment appears to cause interference with radio or television reception, or any other device:
  - a. Verify as an emission source by turning the equipment off and on. If you determine that this equipment is causing the interference, try to correct the interference by using one or more of the following measures:
    - i. Move the digital device away from the affected receiver.
    - ii. Reposition (turn) the digital device with respect to the affected receiver.
    - iii. Reorient the affected receiver's antenna.
    - iv. Plug the digital device into a different AC outlet so the digital device and the receiver are on different branch circuits.
    - v. Disconnect and remove any I/O cables that the digital device does not use.  
(Unterminated I/O cables are a potential source of high RF emission levels.)
    - vi. Plug the digital device into only a grounded outlet receptacle. Do not use AC adapter plugs. (Removing or cutting the line cord ground may increase RF emission levels and may also present a lethal shock hazard to the user.)

If you need additional help, consult your dealer, manufacturer, or an experienced radio or television technician.

## Agency Certifications

The following certifications and marks have been issued or declared for this monitor:

- Argentina S-Mark  
(except for 5501LT and 5551L)
- Australia RCM
- Canada CUL, IC
- China CCC (except for 5551L)
- Europe CE
- Japan VCCI
- Korea KCC  
(except for 5501LT and 5551L)
- Mexico CoC  
(except for 5501LT and 5551L)
- Taiwan BSMI  
(except for 5501LT and 5551L)
- Russia EAC  
(except for 5501LT and 5551L)
- United States FCC, UL
- International CB

## China RoHS

In accordance to Chinese law (Management Methods for the Restriction of the Use of Hazardous Substances in Electrical and Electronic Products), the section below lists out the name and amount of the toxic and/or hazardous materials that this product may contain.

Component Name	Toxic or Hazardous Substances and Elements					
	Lead (Pb)	Mercury (Hg)	Cadmium(Cd)	Hexavalent Chromium (Cr6+)	Polybrominated Biphenyls (PBB)	Polybrominated Diphenyl Ethers (PBDE)
Plastic Parts	O	O	O	O	O	O
Metal Parts	X	O	O	O	O	O
Wire and Cable Assembly	X	O	O	O	O	O
LCD Panel	X	O	O	O	O	O
Touch Screen Panel	X	O	O	O	O	O
PCBA	X	O	O	O	O	O
Software (CD, etc.)	O	O	O	O	O	O

This table is prepared in accordance with the provisions of SJ/T 11364

O: Indicates that said hazardous substance contained in all homogenous materials for this part is below the limit requirement of GB/T 26572.

X: Indicates that said hazardous substance contained in at least one of the homogenous materials used for this part is above the limit requirement of GB/T 26572.

For items marked with X, exemptions were taken according to EU RoHS.

## Explanation of Markings

In accordance with the SJ/T11364 requirement, electrical and electronic products are marked with the following pollution control logo.

The Environment-Friendly Use Period for this product is 10 years. The product will not leak or mutate under normal operating conditions listed below, so that the use of this electronic information product will not result in any severe environmental pollution, any bodily injury, or damage to any assets.



Operating Temperature: See chart below

Storage Temperature: See chart below

It is encouraged and recommended that product packaging be recycled and reused according to local laws.





# Power Specifications

## Electrical Ratings

---

Input	100 - 240VAC, 50/60Hz
-------	-----------------------

---

# Monitor Specifications

## Electrical Ratings

---

Input	ET3201L/4201L: 100 -240Vac 3.6A ET5501L/5501LT/ET5551L: 100 -240Vac 5A ET7001L/ET7001LT: 100 -240Vac 5A
-------	---

---

## Operating Conditions

---

Temperature	0°C - 40°C Portrait and Landscape 0 - 35°C Table Top Mode 0 - 35°C with OPS module
Humidity	20% to 80% (non-condensing)
Altitude	0 to 3,048m

---

## Storage Conditions

---

Temperature	-20°C - 50°C
Humidity	10% to 95% (non-condensing)
Altitude	0 to 3658m (Operating) 0 to 12,192m (non-operating)

---

# Section 8: Warranty Information

For warranty information, go to <http://support.elotouch.com/warranty/>

# Notes

---

---

---

---

---

---

---

---

---

---

---

---

---

---

---

---

---

---

---

---

---

---

---

---

---

---

---

---

# Notes

---

---

---

---

---

---

---

---

---

---

---

---

---

---

---

---

---

---

---

---

---

---

---

---

---

---

---

---

---

---

---

---

---

---

---

---

---

---

---

---

---

---

# www.elotouch.com

Visit our website for the latest

- Product Information
- Specifications
- Upcoming Events
- Press Releases
- Software Drivers
- Touchmonitor Newsletter

To find out more about our extensive range of Elo touch solutions, go to [www.elotouch.com](http://www.elotouch.com), or call the office nearest you.

---

#### North America

Tel +1 408 597 8000

Fax +1 408 597 8001

[customerservice@elotouch.com](mailto:customerservice@elotouch.com)

#### Europe

Tel +32 (0)16 70 45 00

Fax +32 (0)16 70 45 49

[elosales@elotouch.com](mailto:elosales@elotouch.com)

#### Asia-Pacific

Tel +86 (21) 3329 1385

Fax +86 (21) 3329 1400

[www.elotouch.com.cn](http://www.elotouch.com.cn)

#### Latin America

Tel 786-923-0251

Fax 305-931-0124

[www.elotouch.com](http://www.elotouch.com)

