



PRO-10S series Online Manual

Read Me First
Useful Functions Available on the Machine
Overview of the Printer
Printing
Troubleshooting

Contents

Read Me First.	12
Symbols Used in This Document.	13
Trademarks and Licenses.	14
Search Tips.	18
Notes on Operation Explanations.	20
Useful Functions Available on the Machine.	21
Print Photos Easily Using My Image Garden.	22
Create and Print Personalized Disc Labels (CD/DVD/BD) Easily and Beautifully.	24
Download a Variety of Content Materials.	25
Print Items with Easy-PhotoPrint+ (Web Application).	26
Connection Methods Available on the Printer.	27
Restrictions.	28
Print Professional Photos Using Print Studio Pro.	29
Notice for Web Service Printing.	30
Using PIXMA Cloud Link.	32
Using PIXMA Cloud Link from Your Smartphone, Tablet, or Computer.	33
Before Using Canon Inkjet Cloud Printing Center.	34
Requirements for Canon Inkjet Cloud Printing Center operation.	35
Preparations Before Using Canon Inkjet Cloud Printing Center.	36
Canon Inkjet Cloud Printing Center window.	42
Using Canon Inkjet Cloud Printing Center.	58
Adding a Printer.	62
Adding a PIXMA Cloud Link User.	63
Troubleshooting Canon Inkjet Cloud Printing Center.	68
Printing from AirPrint Compliant Device.	70
Checking Printer Information.	75
Print Easily from a Smartphone or Tablet with PIXMA Printing Solutions.	77
Printing with Windows RT.	78
Overview of the Printer.	79
Safety Guide.	80
Safety Precautions.	81
Regulatory and Safety Information.	82

Main Components and Basic Operations.	86
Main Components.	87
Front View.	88
Rear View.	91
Inside View.	92
About the Power Supply of the Printer.	93
Confirming that the Power Is On.	94
Turning the Printer On and Off.	95
Notice for the Power Plug/Power Cord.	97
Notice for Unplugging the Power Cord.	98
Loading Paper.	100
Loading Paper.	101
Paper Sources to Load Paper.	102
Loading Paper in the Rear Tray.	104
Loading Paper in the Manual Feed Tray.	108
Media Types You Can Use.	111
Paper Load Limit.	114
Media Types You Cannot Use.	116
Handling Paper.	117
Before Printing on Art Paper.	118
Printing Area.	120
Printing Area.	121
Other Sizes than Letter or Legal.	122
Letter, Legal.	123
Sizes for Art Paper.	124
Printable Discs.	126
Placing a Printable Disc.	127
Cautions When Printing on a Printable Disc.	128
Before Placing a Printable Disc.	129
Placing a Printable Disc.	130
Removing a Printable Disc.	132
Replacing an Ink Tank.	134
Replacing an Ink Tank.	135
Checking the Ink Status.	139
Checking the Ink Status with the Ink Lamps.	140
Maintenance.	142

When Printing Becomes Faint or Colors Are Incorrect.	143
Maintenance Procedure.	144
Printing the Nozzle Check Pattern.	146
Examining the Nozzle Check Pattern.	147
Cleaning the Print Head.	149
Aligning the Print Head.	150
Performing Maintenance from a Computer.	151
Cleaning the Print Heads from Your Computer.	152
Cleaning Inside the Printer.	154
Cleaning the Paper Feed Rollers from Your Computer.	155
Use Your Computer to Print a Nozzle Check Pattern.	156
Aligning the Print Head.	157
Aligning the Print Head Position from Your Computer.	158
Aligning the Print Head Position Manually from Your Computer.	159
Maintaining the Ink Quality.	163
Cleaning the Printer.	164
Cleaning the Exterior of the Printer.	165
Cleaning the Paper Feed Roller.	166
Cleaning the Inside of the Printer (Bottom Plate Cleaning).	167
Changing the Printer Settings.	168
Changing Printer Settings from Your Computer.	169
Checking the Ink Status from Your Computer.	170
Registering a Changed Printing Profile.	171
Managing the Printer Power.	173
Reducing the Printer Noise.	175
Changing the Printer Operation Mode.	177
Initializing the Printer Settings.	179
Disabling the LAN Function of the Printer.	180
Information about Network Connection.	181
Useful Information about Network Connection.	182
Default Values Set at Factory (Network).	183
Connecting the Printer to the Computer Using a USB Cable.	184
When Detecting the Printers Have the Same Name.	185
Connecting to Other Computer with LAN/Changing the Connection Method from USB to LAN.	186
Printing Out Network Setting Information.	187
About Network Communication.	190
Changing and Confirming Network Settings.	191

IJ Network Tool.	192
Canon IJ Network Tool Screen.	193
Canon IJ Network Tool Menus.	195
Changing the Settings in the Wireless LAN Sheet.	197
Changing the WEP Detailed Settings.	201
Changing the WPA/WPA2 Detailed Settings.	203
Changing the Settings in the Wired LAN Sheet.	205
Changing the Settings in the Admin Password Sheet.	206
Monitoring Wireless Network Status.	208
Initializing the Network Settings of the Machine.	210
Viewing the Modified Settings.	211
Appendix for Network Communication.	212
Using the Card Slot over a Network.	213
About Technical Terms.	215
Restrictions.	222
Tips for Ensuring Optimal Printing Quality.	223
Useful Information about Ink.	224
Key Points to Successful Printing.	225
Be Sure to Make Paper Settings after Loading Paper.	227
Canceling a Print Job.	228
Printer Handling Precautions.	229
Key to Enjoying Consistent Printing Quality.	230
Precautions for Safe Transport of the Printer.	231
Legal Limitations on Use of Your Product and Use of Images.	232
Specifications.	233
About the Administrator Password.	236
List of Function for Each Model.	237
Printing.	240
Printing from a Computer.	241
Printing with Application Software that You are Using (Printer Driver).	242
Printing with Easy Setup.	243
Paper Settings on the Printer Driver.	247
Various Printing Methods.	248
Setting the Number of Copies and Printing Order.	249
Setting the Stapling Margin.	251
Execute Borderless Printing.	252

Scaling the Printing to Fit the Paper Size.	255
Scaled Printing.	257
Page Layout Printing.	258
Printing on Postcards.	260
Changing the Clear Coating Settings.	261
Create or Delete a Form File.	264
Switching the Paper Source to Match the Purpose.	266
Setting Paper Dimensions (Custom Size).	268
Changing the Print Quality and Correcting Image Data.	270
Setting the Print Quality Level (Custom).	271
Printing a Color Document in Monochrome.	272
Adjusting Tone.	273
Specifying Color Correction.	276
Optimal Photo Printing of Image Data.	278
Adjusting Colors with the Printer Driver.	279
Printing with ICC Profiles (Specifying an ICC Profile from the Application Software).	281
Printing with ICC Profiles (Specifying an ICC Profile from the Printer Driver).	283
Interpreting the ICC Profile.	284
Adjusting Color Balance.	285
Adjusting Brightness.	287
Adjusting Intensity.	289
Adjusting Contrast.	291
Overview of the Printer Driver.	293
Canon IJ Printer Driver.	294
How to Open the Printer Driver Setup Window.	295
Page Setup Dialog.	296
Print Dialog.	297
Quality & Media.	299
Color Options.	301
Clear Coating.	303
Borderless Printing.	306
Margin.	307
Canon IJ Printer Utility.	308
Opening the Canon IJ Printer Utility.	310
Maintenance of this Printer.	311
Display the Printing Status Screen.	312
Deleting the Undesired Print Job.	314
Instructions for Use (Printer Driver).	315
Updating the Printer Driver.	316

Obtaining the Latest Printer Driver.	317
Delete the Unnecessary Canon IJ Printer from the Printer List.	318
Before Installing the Printer Driver.	319
Installing the Printer Driver.	320
Printing from a Digital Camera.	321
Printing Photographs Directly from a PictBridge Compliant Device.	322
About PictBridge Print Settings.	324
Troubleshooting.	326
Problems with Network Communication.	327
Cannot Detect a Printer on a Network.	328
Cannot Detect the Printer when Setting Up Network Communication.	329
Cannot Detect the Printer during Wireless LAN Setup: Check 1.	330
Cannot Detect the Printer during Wireless LAN Setup: Check 2.	331
Cannot Detect the Printer during Wireless LAN Setup: Check 3.	332
Cannot Detect the Printer during Wireless LAN Setup: Check 4.	333
Cannot Detect the Printer during Wired LAN Setup: Check 1.	334
Cannot Detect the Printer during Wired LAN Setup: Check 2.	335
Cannot Detect the Printer during Wired LAN Setup: Check 3.	336
The Printer Cannot Be Detected in the Wireless LAN.	337
The Printer Cannot Be Detected in the Wired LAN.	339
Problems with the Printer while Using with Network.	340
The Printer Stopped Working Suddenly.	341
Forgot a Wireless Router Name, SSID, or a Network Key.	344
The Administrator Password Set to the Printer Was Forgotten.	346
Cannot Use the Printer on Replacing a Wireless Router or Changing Its Settings.	347
Printing Speed Is Slow.	349
Other Problems with Network.	350
The Message Is Displayed on the Computer Screen during Setup.	351
Checking Information about the Network.	353
How to Restore the Printer's Network Settings to Factory Default.	355
Problems while Printing from Smartphone/Tablet.	356
Cannot Print from Smartphone/Tablet.	357
Problems with Printing.	359
Printing Does Not Start.	360
Paper Jams.	362
Print Results Not Satisfactory.	363

Cannot Print to End of Job.	365
No Printing Results/Printing Is Blurred/Colors Are Wrong/White Streaks.	366
Lines Are Misaligned.	369
Printed Paper Curls or Has Ink Blots.	370
Paper Is Smudged/Printed Surface Is Scratched.	371
Back of the Paper Is Smudged.	374
Vertical Lines Are Printed on the Sides of the Printout.	375
Colors Are Uneven or Streaked.	376
Ink Is Not Ejected.	378
Paper Does Not Feed Properly/"No Paper" Error Occurs.	379
Cannot Print on the Disc Label.	381
Printing Stops Before It Is Completed.	383
Problems with the Printer.	384
The Printer Cannot Be Powered On.	385
The Printer Turns Off Unintentionally.	386
Cannot Connect to Computer with a USB Cable Properly.	387
Cannot Communicate with the Printer with USB Connection.	388
Print Head Holder Does Not Move to the Position for Replacing.	389
The Printer Is Vibrating/The Printer Is Making an Operation Noise Even When the Printer Is Not in Use.	390
Problems with Installation/Downloading.	391
Cannot Install the Printer Driver.	392
Uninstalling IJ Network Tool.	393
About Errors/Messages Displayed.	394
If an Error Occurs.	395
A Message Is Displayed.	398
Error Message Appears on a PictBridge Compliant Device.	401
If You Cannot Resolve the Problem.	403
List of Support Code for Error(PRO-10S).	404
List of Support Code for Error (When Paper Is Jammed).	406
1300.	407
Paper Is Jammed inside the Printer.	410
In Other Cases.	413
1000.	414
1001.	415
1002.	416

1006.	417
1062.	418
1200.	419
1250.	420
1261.	421
1270.	422
1308.	423
1350.	424
1351.	425
1401.	426
1403.	427
1405.	428
1410.	429
1411.	430
1412.	431
1413.	432
1414.	433
1415.	434
1416.	435
1417.	436
1418.	437
1419.	438
1600.	439
1660.	440
1680.	441
1681.	442
1684.	443
1698.	444
1699.	445
1700.	446
1701.	447
1750.	448
1850.	449
1851.	450

1855.	451
1856.	452
1859.	453
185A.	454
2001.	455
2002.	456
2103.	457
2500.	458
4100.	459
4103.	460
5100.	461
5110.	462
5200.	463
5250.	464
5400.	465
5700.	466
5B00.	467
5B01.	468
5C00.	469
5C20.	470
6000.	471
6010.	472
6500.	473
6502.	474
6700.	475
6800.	476
6801.	477
6900.	478
6901.	479
6902.	480
6910.	481
6911.	482
6920.	483
6921.	484

6930.....	485
6931.....	486
6932.....	487
6933.....	488
6940.....	489
6941.....	490
6942.....	491
6943.....	492
6944.....	493
6945.....	494
6946.....	495
6A00.....	496
6B00.....	497
8200.....	498
9000.....	499
9400.....	500
B200.....	501
B400.....	502

Read Me First

- [Notes on Online Manual Usage](#)
- [How to Print](#)

Notes on Online Manual Usage

- Reproduction, diversion or copying of any text, photo or image published in the *Online Manual* (hereinafter referred to as "this guide"), in whole or in part, is prohibited.
- In principle, Canon shall change or delete the contents of this guide without prior notice to customers. In addition, Canon may suspend or stop the disclosure of this guide due to unavoidable reasons. Canon shall not be liable for any damage suffered by customers as a result of changes in or deletion of information in this guide, or suspension/stoppage of disclosure of this guide.
- Although the contents of this guide have been prepared with utmost care, please contact the service center if you find any incorrect or missing information.
- In principle, the descriptions in this guide are based on the product at the time of its initial sale.
- This guide does not disclose the manuals of all the products sold by Canon. See the manual supplied with the product when using a product that is not described in this guide.

How to Print

Use the print function of your Web browser to print this guide.

To print background colors and images, follow the steps below to display the Print dialog options, then select the **Print backgrounds** checkbox.

1. Click **Print...** from the **File** menu.
2. Click **Show Details** or  (Down Arrow).
3. Select **Safari** from the pop-up menu.

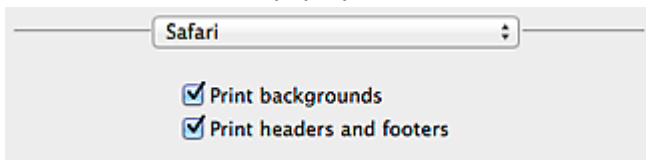

Symbols Used in This Document

Warning

Instructions that, if ignored, could result in death or serious personal injury caused by incorrect operation of the equipment. These must be observed for safe operation.

Caution

Instructions that, if ignored, could result in personal injury or material damage caused by incorrect operation of the equipment. These must be observed for safe operation.

Important

Instructions including important information. To avoid damage and injury or improper use of the product, be sure to read these indications.

Note

Instructions including notes for operation and additional explanations.

Basic

Instructions explaining basic operations of your product.

Note

-
- Icons may vary depending on your product.

Trademarks and Licenses

- Microsoft is a registered trademark of Microsoft Corporation.
- Windows is a trademark or registered trademark of Microsoft Corporation in the U.S. and/or other countries.
- Windows Vista is a trademark or registered trademark of Microsoft Corporation in the U.S. and/or other countries.
- Internet Explorer is a trademark or registered trademark of Microsoft Corporation in the U.S. and/or other countries.
- Mac, Mac OS, AirPort, Safari, Bonjour, iPad, iPhone and iPod touch are trademarks of Apple Inc., registered in the U.S. and other countries. AirPrint and the AirPrint logo are trademarks of Apple Inc.
- IOS is a trademark or registered trademark of Cisco in the U.S. and other countries and is used under license.
- Google Cloud Print, Google Chrome, Android, Google Play and Picasa are either registered trademarks or trademarks of Google Inc.
- Adobe, Photoshop, Photoshop Elements, Lightroom, Adobe RGB and Adobe RGB (1998) are either registered trademarks or trademarks of Adobe Systems Incorporated in the United States and/or other countries.
- Photo Rag is a trademark of Hahnemühle FineArt GmbH.
- Bluetooth is a trademark of Bluetooth SIG, Inc., U.S.A. and licensed to Canon Inc.

Note

- The formal name of Windows Vista is Microsoft Windows Vista operating system.

Copyright (c) 2003-2004, Apple Computer, Inc. All rights reserved.

Redistribution and use in source and binary forms, with or without modification, are permitted provided that the following conditions are met:

1. Redistributions of source code must retain the above copyright notice, this list of conditions and the following disclaimer.
2. Redistributions in binary form must reproduce the above copyright notice, this list of conditions and the following disclaimer in the documentation and/or other materials provided with the distribution.
3. Neither the name of Apple Computer, Inc. ("Apple") nor the names of its contributors may be used to endorse or promote products derived from this software without specific prior written permission.

THIS SOFTWARE IS PROVIDED BY APPLE AND ITS CONTRIBUTORS "AS IS" AND ANY EXPRESS OR IMPLIED WARRANTIES, INCLUDING, BUT NOT LIMITED TO, THE IMPLIED WARRANTIES OF MERCHANTABILITY AND FITNESS FOR A PARTICULAR PURPOSE ARE DISCLAIMED. IN NO EVENT SHALL APPLE OR ITS CONTRIBUTORS BE LIABLE FOR ANY DIRECT, INDIRECT, INCIDENTAL, SPECIAL, EXEMPLARY, OR CONSEQUENTIAL DAMAGES (INCLUDING, BUT NOT LIMITED TO, PROCUREMENT OF SUBSTITUTE GOODS OR SERVICES; LOSS OF USE, DATA, OR PROFITS; OR BUSINESS INTERRUPTION) HOWEVER CAUSED AND ON ANY THEORY OF LIABILITY, WHETHER IN CONTRACT, STRICT LIABILITY, OR TORT INCLUDING NEGLIGENCE OR OTHERWISE) ARISING IN ANY WAY OUT OF THE USE OF THIS SOFTWARE, EVEN IF ADVISED OF THE POSSIBILITY OF SUCH DAMAGE.

Apache License

Version 2.0, January 2004

<http://www.apache.org/licenses/>

TERMS AND CONDITIONS FOR USE, REPRODUCTION, AND DISTRIBUTION

1. Definitions.

"License" shall mean the terms and conditions for use, reproduction, and distribution as defined by Sections 1 through 9 of this document.

"Licensor" shall mean the copyright owner or entity authorized by the copyright owner that is granting the License.

"Legal Entity" shall mean the union of the acting entity and all other entities that control, are controlled by, or are under common control with that entity. For the purposes of this definition, "control" means (i) the power, direct or indirect, to cause the direction or management of such entity, whether by contract or otherwise, or (ii) ownership of fifty percent (50%) or more of the outstanding shares, or (iii) beneficial ownership of such entity.

"You" (or "Your") shall mean an individual or Legal Entity exercising permissions granted by this License.

"Source" form shall mean the preferred form for making modifications, including but not limited to software source code, documentation source, and configuration files.

"Object" form shall mean any form resulting from mechanical transformation or translation of a Source form, including but not limited to compiled object code, generated documentation, and conversions to other media types.

"Work" shall mean the work of authorship, whether in Source or Object form, made available under the License, as indicated by a copyright notice that is included in or attached to the work (an example is provided in the Appendix below).

"Derivative Works" shall mean any work, whether in Source or Object form, that is based on (or derived from) the Work and for which the editorial revisions, annotations, elaborations, or other modifications represent, as a whole, an original work of authorship. For the purposes of this License, Derivative Works shall not include works that remain separable from, or merely link (or bind by name) to the interfaces of, the Work and Derivative Works thereof.

"Contribution" shall mean any work of authorship, including the original version of the Work and any modifications or additions to that Work or Derivative Works thereof, that is intentionally submitted to Licensor for inclusion in the Work by the copyright owner or by an individual or Legal Entity authorized to submit on behalf of the copyright owner. For the purposes of this definition, "submitted" means any form of electronic, verbal, or written communication sent to the Licensor or its representatives, including but not limited to communication on electronic mailing lists, source code control systems, and issue tracking systems that are managed by, or on behalf of, the Licensor for the purpose of discussing and improving the Work, but excluding communication that is conspicuously marked or otherwise designated in writing by the copyright owner as "Not a Contribution."

"Contributor" shall mean Licensor and any individual or Legal Entity on behalf of whom a Contribution has been received by Licensor and subsequently incorporated within the Work.

2. Grant of Copyright License. Subject to the terms and conditions of this License, each Contributor hereby grants to You a perpetual, worldwide, non-exclusive, no-charge, royalty-free, irrevocable copyright license to reproduce, prepare Derivative Works of, publicly display, publicly perform, sublicense, and distribute the Work and such Derivative Works in Source or Object form.
3. Grant of Patent License. Subject to the terms and conditions of this License, each Contributor hereby grants to You a perpetual, worldwide, non-exclusive, no-charge, royalty-free, irrevocable (except as stated in this section) patent license to make, have made, use, offer to sell, sell, import, and otherwise transfer the Work, where such license applies only to those patent claims licensable by such Contributor that are necessarily infringed by their Contribution(s) alone or by combination of

their Contribution(s) with the Work to which such Contribution(s) was submitted. If You institute patent litigation against any entity (including a cross-claim or counterclaim in a lawsuit) alleging that the Work or a Contribution incorporated within the Work constitutes direct or contributory patent infringement, then any patent licenses granted to You under this License for that Work shall terminate as of the date such litigation is filed.

4. Redistribution. You may reproduce and distribute copies of the Work or Derivative Works thereof in any medium, with or without modifications, and in Source or Object form, provided that You meet the following conditions:
 1. You must give any other recipients of the Work or Derivative Works a copy of this License; and
 2. You must cause any modified files to carry prominent notices stating that You changed the files; and
 3. You must retain, in the Source form of any Derivative Works that You distribute, all copyright, patent, trademark, and attribution notices from the Source form of the Work, excluding those notices that do not pertain to any part of the Derivative Works; and
 4. If the Work includes a "NOTICE" text file as part of its distribution, then any Derivative Works that You distribute must include a readable copy of the attribution notices contained within such NOTICE file, excluding those notices that do not pertain to any part of the Derivative Works, in at least one of the following places: within a NOTICE text file distributed as part of the Derivative Works; within the Source form or documentation, if provided along with the Derivative Works; or, within a display generated by the Derivative Works, if and wherever such third-party notices normally appear. The contents of the NOTICE file are for informational purposes only and do not modify the License. You may add Your own attribution notices within Derivative Works that You distribute, alongside or as an addendum to the NOTICE text from the Work, provided that such additional attribution notices cannot be construed as modifying the License.

You may add Your own copyright statement to Your modifications and may provide additional or different license terms and conditions for use, reproduction, or distribution of Your modifications, or for any such Derivative Works as a whole, provided Your use, reproduction, and distribution of the Work otherwise complies with the conditions stated in this License.

5. Submission of Contributions. Unless You explicitly state otherwise, any Contribution intentionally submitted for inclusion in the Work by You to the Licensor shall be under the terms and conditions of this License, without any additional terms or conditions. Notwithstanding the above, nothing herein shall supersede or modify the terms of any separate license agreement you may have executed with Licensor regarding such Contributions.
6. Trademarks. This License does not grant permission to use the trade names, trademarks, service marks, or product names of the Licensor, except as required for reasonable and customary use in describing the origin of the Work and reproducing the content of the NOTICE file.
7. Disclaimer of Warranty. Unless required by applicable law or agreed to in writing, Licensor provides the Work (and each Contributor provides its Contributions) on an "AS IS" BASIS, WITHOUT WARRANTIES OR CONDITIONS OF ANY KIND, either express or implied, including, without limitation, any warranties or conditions of TITLE, NON-INFRINGEMENT, MERCHANTABILITY, or FITNESS FOR A PARTICULAR PURPOSE. You are solely responsible for determining the appropriateness of using or redistributing the Work and assume any risks associated with Your exercise of permissions under this License.
8. Limitation of Liability. In no event and under no legal theory, whether in tort (including negligence), contract, or otherwise, unless required by applicable law (such as deliberate and grossly negligent acts) or agreed to in writing, shall any Contributor be liable to You for damages, including any direct, indirect, special, incidental, or consequential damages of any character arising as a result of this License or out of the use or inability to use the Work (including but not limited to damages for loss of

goodwill, work stoppage, computer failure or malfunction, or any and all other commercial damages or losses), even if such Contributor has been advised of the possibility of such damages.

9. **Accepting Warranty or Additional Liability.** While redistributing the Work or Derivative Works thereof, You may choose to offer, and charge a fee for, acceptance of support, warranty, indemnity, or other liability obligations and/or rights consistent with this License. However, in accepting such obligations, You may act only on Your own behalf and on Your sole responsibility, not on behalf of any other Contributor, and only if You agree to indemnify, defend, and hold each Contributor harmless for any liability incurred by, or claims asserted against, such Contributor by reason of your accepting any such warranty or additional liability.

END OF TERMS AND CONDITIONS

Enter keywords in the search window and click  (Search).

You can search for target pages in this guide.

Entry example: "(your product's model name) load paper"

Search Tips

You can search for target pages by entering keywords in the search window.

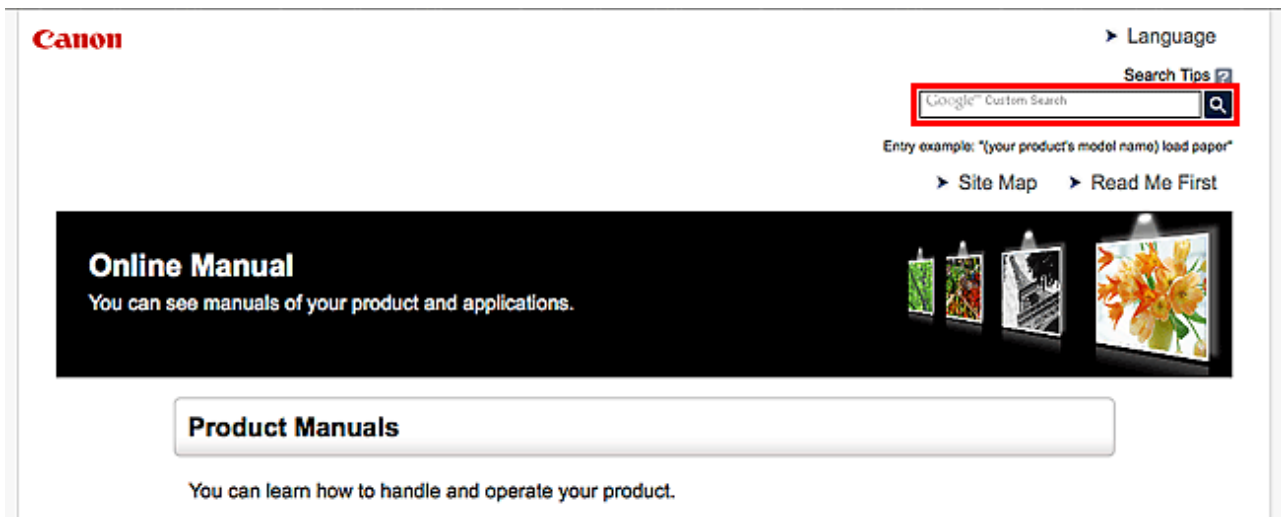

▶▶▶ Note

- The displayed screen may vary.
- When searching from this page or the "Home" page without entering your product's model name or your application's name, all products supported by this guide will be considered for the search. If you want to narrow down the search results, add your product's model name or your application's name to the keywords.

• Searching for Functions

Enter your product's model name and a keyword for the function you want to learn about

Example: When you want to learn how to load paper

Enter "(your product's model name) load paper" in the search window and perform a search

• Troubleshooting Errors

Enter your product's model name and a support code

Example: When the following error screen appears

Enter "(your product's model name) 1000" in the search window and perform a search

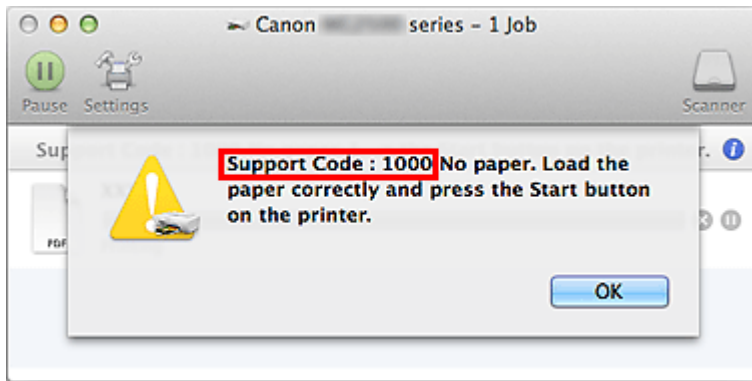

►► Note

- The displayed screen varies depending on your product.

• Searching for Application Functions

Enter your application's name and a keyword for the function you want to learn about

Example: When you want to learn how to print collages with My Image Garden

Enter "My Image Garden collage" in the search window and perform a search

• Searching for Reference Pages

Enter your model name and a reference page title*

* You can find reference pages more easily by entering the function name as well.

Example: When you want to browse the page referred to by the following sentence on a scanning procedure page

Refer to "Color Settings Tab" for your model from Home of the *Online Manual* for details.

Enter "(your product's model name) scan Color Settings Tab" in the search window and perform a search

Notes on Operation Explanations

In this guide, most of the operations are described based on the windows displayed when OS X Mavericks v10.9 is used.

Useful Functions Available on the Machine

- ▶ **Print Photos Easily Using My Image Garden**
- ▶ **Create and Print Personalized Disc Labels (CD/DVD/BD) Easily and Beautifully**
- ▶ **Download a Variety of Content Materials**
- ▶ **Print Items with Easy-PhotoPrint+ (Web Application)**
- ▶ **Connection Methods Available on the Printer**
- ▶ **Print Professional Photos Using Print Studio Pro**
- ▶ **Using PIXMA Cloud Link**
- ▶ **Printing from AirPrint Compliant Device**
- ▶ **Checking Printer Information**
- ▶ **Print Easily from a Smartphone or Tablet with PIXMA Printing Solutions**
- ▶ **Printing with Windows RT**

Print Photos Easily Using My Image Garden

Organize Images Easily

In My Image Garden, you can register the names of people and events to photos. You can organize photos easily as you can display them not only by folder but also by calendar, event, and person. This also allows you to find the target photos easily when you search for them later on.

<Calendar View>



<People View>

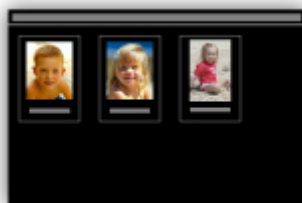

Display Recommended Items in Slide Shows

Based on the information registered to photos, Quick Menu automatically selects the photos on your computer and creates recommended items such as collages and cards. The created items appear in slide shows.



If there is an item you like, you can easily print it in just two steps.

1. In Image Display of Quick Menu, select the item you want to print.
2. Print the item with My Image Garden.



Place Photos Automatically

Delightful items are created easily as the selected photos are placed automatically according to the theme.



Other Various Functions

My Image Garden has many other useful functions.

Refer to "What You Can Do with My Image Garden" for details.

Create and Print Personalized Disc Labels (CD/DVD/BD) Easily and Beautifully

Create Items with Applications and Print Them

Use My Image Garden to combine your favorite photos with preset themes to create and print personalized disc labels.

Refer to "Printing Disc Labels (CD/DVD/BD)" for details.



Download a Variety of Content Materials

CREATIVE PARK

A "printing materials site" where you can download all the printing materials for free.

Various types of content such as seasonal cards and paper crafts that can be made by assembling paper parts are provided.

It is easily accessible from Quick Menu.

CREATIVE PARK PREMIUM

A service where customers using models that support PREMIUM Contents can download exclusive printing materials.

PREMIUM Contents can be downloaded easily via My Image Garden. Downloaded PREMIUM Contents can be printed directly with My Image Garden.

To download PREMIUM Contents, make sure that genuine Canon ink tanks/ink cartridges are installed for all colors on a supported printer.



►► Note

- The designs of PREMIUM Contents provided in this page are subject to change without prior notice.

Print Items with Easy-PhotoPrint+ (Web Application)

You can easily create and print personalized items such as calendars and collages, anytime and anywhere, by simply accessing Easy-PhotoPrint+ on the web from a computer or tablet.

By using Easy-PhotoPrint+, you can create items in the latest environment without going through the trouble of installation.

Moreover, you can use various photos for your item through integration with social networks such as Facebook, or with online storage, web albums, etc.

Refer to "Easy-PhotoPrint+ Guide" for details.



Connection Methods Available on the Printer

The following connection methods are available on the printer.



Wireless Connection

- Connect the printer and a device using a wireless router.
- Connection methods vary depending on the wireless router type.
- You can change network settings such as the SSID and security protocol on the printer.
- When the connection between a device and a wireless router is completed and  (Wi-Fi icon) is displayed in the device's screen, you can connect the device to the printer using the wireless router.

Wired Connection

Connect the printer and a hub or router with an Ethernet cable. Prepare an Ethernet cable.

USB Connection

Connect the printer and a computer with a USB cable. Prepare a USB cable.

Restrictions

(Appears in a new window)

Restrictions

Connection Using a Wired Network cannot be performed on printers that do not support a wired connection.

Connection Using a Wireless Router

- This printer cannot be used over wireless and wired connections at the same time.
- Make sure that a device and a wireless router are connected. For details on how to check the settings, refer to the manual supplied with the wireless router or contact its manufacturer.
As for a device already connected to the printer without using a wireless router, reconnect it via a wireless router.
- The configuration, router functions, setup procedures and security settings of the network device vary depending on your system environment. For details, refer to the manual of your network device or contact its manufacturer.
- Check if your device supports IEEE802.11n (2.4 GHz), IEEE802.11g or IEEE802.11b.
- If your device is set to the "IEEE802.11n only" mode, WEP or TKIP cannot be used as a security protocol. Change the security protocol for your device to something other than WEP and TKIP or change the setting to something other than "IEEE802.11n only."
The connection between your device and the wireless router will be temporarily disabled while changing the setting. Do not operate the screen of this guide until the setup is complete.
- For office use, consult your network administrator.
- Take added care when connecting to a network that is not protected with security measures, as there is a risk of disclosing data such as your personal information to a third party.

Connection Using a Wired Network

- This printer cannot be used over wireless and wired connections at the same time.
- When using a router, connect the printer and a device to the LAN side (same network segment).

Print Professional Photos Using Print Studio Pro

Print Studio Pro is a plug-in that makes professional photo printing easier and more convenient.

In addition to printing bordered photos and borderless photos, you can perform various printing tasks such as index printing, grayscale printing and printing using ICC profiles.

You can also adjust the margins or add text.



Print Studio Pro has many other useful functions.

Refer to "What You Can Do with Print Studio Pro" for details.

Notice for Web Service Printing

When Using Web Service

- Canon does not guarantee the continuity and reliability of the web services provided, the availability of site access, or permission to download the materials.
- Canon may at any time update, change, or delete the information provided through the web service, or may suspend or discontinue the service without prior notice. Canon shall not be held responsible for any damages resulting from such actions.
- In no event shall Canon be liable for any damages whatsoever resulting from the use of the web services.
- User registration is necessary before using the photo sharing site.
When you use the photo sharing site, observe the conditions of use of the site and use the service within your own responsibility.
- All or part of the web service may not be available depending on the country or region you live in.
- Depending on your network environment, some functions on web service are not available. Even if they are available, it may take a while to print or display the contents, or communication may be interrupted while operation is in progress.
- When you use web service, your machine's name, information of your region or country, your selected language, and what kind of service you use (e.g. photo sharing site) are sent to and saved in our server. Canon is unable to identify specific customers using this information.
- Your login name and password for the photo sharing site are saved in the machine's memory (not encrypted).
If you hand over the machine to anyone or dispose of it, delete your login name and password from the machine's memory in advance.
- The account information will be sent to Canon Inc. server (located in Japan), then forwarded to the service provider's server.
- Canon handles your account information as follows:
 - Your account information will be used in personal identification process of the selected service.
 - Canon will not provide your account information to any third party without your consent, except for sending to the service provider or providing based on laws and regulations.
 - After the conclusion of non-disclosure agreement, Canon may deposit your account information to the contractor to achieve the purpose of use.
 - Canon endeavors to secure the safety of your account information.
 - It is at your option to enter and send your account information. However, the service that requires to enter your account information is not available unless you enter and send it.
 - Your account information does not remain in Canon Inc. server. At the latest, it will be deleted when you have disconnected your printer from LAN.
 - For details, contact a Canon-authorized sales representative in the country or region you live in.

Copyrights and Rights of Publicity

When printing from the photo sharing site:

- Observe the conditions of use of the photo sharing site when you use photos on the site.
- It is unlawful to reproduce or edit the copyrighted work of another person without permission from the copyright holder, except for personal use, use within the home, or other use within the limited scope as defined by the copyright. Additionally, reproducing or editing photographs of people may infringe on Rights of Publicity.

When printing downloaded template forms:

1. The copyright of each material (photos, illustrations, logos, or documents: hereinafter referred to as "the materials") provided on the web template printing service belongs to their respective owners. Issues pertaining to Rights of Publicity may arise regarding the use of any of people or characters displayed on the web template printing service.

Except as otherwise permitted (please see "2" below), copying, modifying or distributing all or a portion of any of the materials contained on the web template printing service without prior consent of the respective rights (Rights of Publicity and Copyright) holder is strictly prohibited.

2. All of the materials provided on the web template printing service can be freely used for personal and non-commercial purposes.

Using PIXMA Cloud Link

By using PIXMA Cloud Link, you can connect your printer to a cloud service, such as CANON iMAGE GATEWAY, Evernote, or Twitter, and use the following functions without using a computer:

- Print images from a photo-sharing service
- Print documents from a data management service
- Use Twitter to report the printer status, such as no paper or low ink levels.

In addition, you can use various functions by adding and registering apps that are linked with various cloud services.

■ [Using PIXMA Cloud Link from Your Smartphone, Tablet, or Computer](#)



▶▶▶ Important

- In certain countries, PIXMA Cloud Link may not be available or the available apps may be different.
- Some apps require that you have an account before you use those apps. For such apps, please set up an account beforehand.
- To find out which models support PIXMA Cloud Link check the Canon homepage.
- The screen display may change without prior notice.

Using PIXMA Cloud Link from Your Smartphone, Tablet, or Computer

- ▶ **Before Using Canon Inkjet Cloud Printing Center**
- ▶ **Preparations Before Using Canon Inkjet Cloud Printing Center**
- ▶ **Using Canon Inkjet Cloud Printing Center**
- ▶ **Adding a Printer**
- ▶ **Adding a PIXMA Cloud Link User**
- ▶ **Troubleshooting Canon Inkjet Cloud Printing Center**

Before Using Canon Inkjet Cloud Printing Center

Canon Inkjet Cloud Printing Center is a service that links with the cloud function of the printer and allows you to perform operations such as registering and managing apps from your smartphone or tablet device, and checking the print status, print error, and ink status of the printer. You can also print app photos and documents from your smartphone or tablet.

First, check the following content:

- **Precautions**

If you plan to use the web service to print documents, be sure to check these [precautions](#) beforehand.

- **Printer specification**

Check that Canon Inkjet Cloud Printing Center supports the printer.

- **Network environment**

The printer must be connected to a LAN and to the Internet.

▶▶▶ Important

- The user will bear the cost of Internet access.

- **Operating requirements**

For computers, smartphones, and tablet devices, see "[Requirements for Canon Inkjet Cloud Printing Center operation](#)".

▶▶▶ Important

- This service may not be available in certain countries or regions. Also even if the service is available, there are apps that cannot be used in certain regions.

■ [Preparations Before Using Canon Inkjet Cloud Printing Center](#)

Requirements for Canon Inkjet Cloud Printing Center operation

Computer

CPU	x86 or x64 1.6 GHz or higher
RAM	2 GB or higher
Monitor display	Resolution 1024 x 768 pixels or higher Number of display colors 24 bits (true-color) or higher

OS	Browser
Windows XP SP3 or later	Internet Explorer 8* Mozilla Firefox Google Chrome
Windows Vista SP1 or later	Internet Explorer 8*, 9 Mozilla Firefox Google Chrome
Windows 7	Internet Explorer 8*, 9, 10, 11 Mozilla Firefox Google Chrome
Windows 8	Internet Explorer 10 Mozilla Firefox Google Chrome
Windows 8.1	Internet Explorer 11 Mozilla Firefox Google Chrome
Mac OS X v10.6-OS X Mavericks v10.9	Safari 5.1, 6, 7

* When you use Internet Explorer 8, the web pages may not display correctly. Canon recommends that you upgrade to Internet Explorer 9 or later, or use another browser.

Smartphone or tablet

OS	Browser	Resolution
iOS 5.1 or later	OS standard browser	320 x 480 (HVGA) or higher
Android 2.3.3 or later		480 x 800 (HVGA) or higher

*Android3.x is not supported.

Important

- On the browser you are using, enable JavaScript and cookies.
- If you use the zoom function or change the font size on your browser, the web pages may not display correctly.
- If you use the translation function of Google Chrome, the web pages may not display correctly.
- If you use a proxy server outside of your country, the service may not be able to determine the correct region.
- In an in-house network environment, the 5222 port must be released. For confirmation instructions, contact the network administrator.

Preparations Before Using Canon Inkjet Cloud Printing Center

To use the Canon Inkjet Cloud Printing Center, you need to follow the steps described below and register the user information.



1. Check that the printer is connected to the Internet

»» Important

- To use this function, you must connect this printer to the Internet.

2. [Displaying Printer Information](#)
3. Select **IJ Cloud Printing Center setup -> Register with this service**
4. Follow the instructions displayed in the window, and run the authentication
5. When the printer registration screen is displayed, select **Create new account**



6. Enter the **E-mail address** of the printer's owner, and then select **OK**

The registration page URL is sent to the e-mail address entered.

Preparation

To create an account, enter your e-mail address.

An e-mail from "noreply@mail.cs.c-ij.com" will be sent to the specified e-mail address. If you use e-mail filters, be sure to allow e-mail from this address.

An e-mail address that is already registered cannot be used.

E-mail address:

Cancel OK

▶▶▶ Important

- There are character restrictions for the e-mail address, as shown below.
 - Up to 255 characters consisting of single-byte alphanumeric characters and symbols (!\$*/^_{}|~.-@). (Uppercase and lowercase letters are differentiated.)
 - Multibyte characters cannot be used.

You will get an error if the e-mail address you enter contains a character that cannot be used.
- If you registered a different e-mail address by mistake, you can cancel the registration by [Displaying Printer Information](#) and selecting **IJ Cloud Printing Center setup -> Delete from this service**.
- You may not be able to receive the notification if you are using a spam filter. If you have a setting to receive only the e-mails from certain domains, be sure to change the setting to allow receiving e-mails from "noreply@mail.cs.c-ij.com".
There will be no error display even if you could not receive the e-mail because of the spam filter setting or if you entered an incorrect e-mail address.

7. When an e-mail with the subject "Information on Canon Inkjet Cloud Printing Center" is sent to the e-mail address that you entered, select the URL
8. In the **License agreement** and **Privacy statement** windows of Canon Inkjet Cloud Printing Center, read the statements, and select **Agree** if you agree

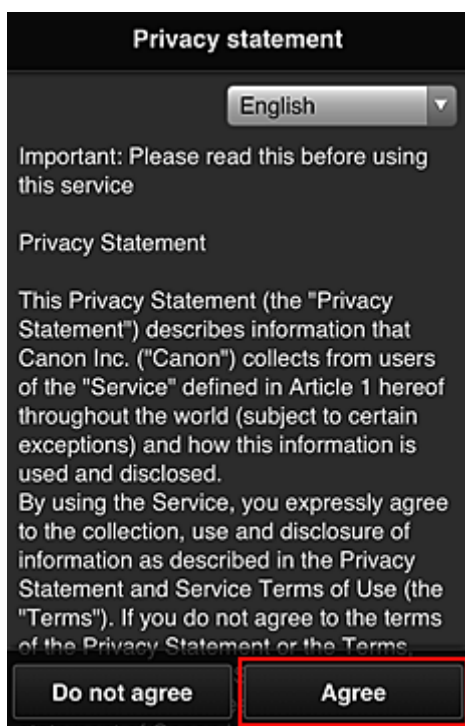
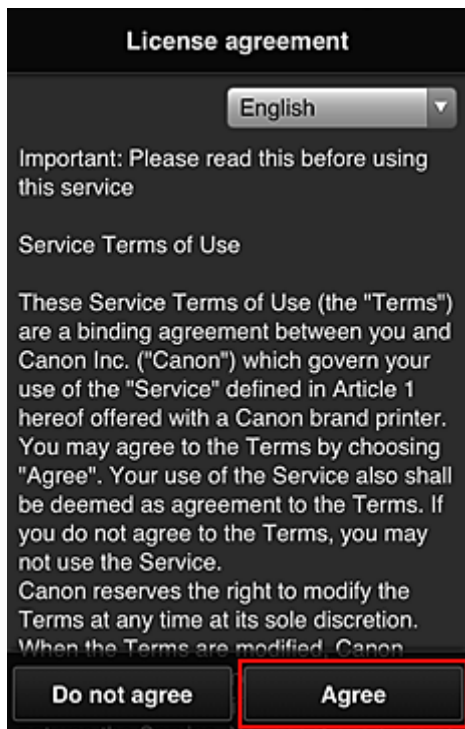

9. In the user information entry screen, enter your **Password**, and select **Next**

Enter your password for logging in to the Canon Inkjet Cloud Printing Center.

Register user info

Set a password for logging into this service.

Password:

Password (Confirmation):

8 to 32 characters

Cancel Next

»»» Important

- There are character restrictions for the **Password**, as shown below.
- The password must be between 8 and 32 characters long, using single-byte alphanumeric characters and symbols (!"#%&'()*+,-./:;<=>@[^_`{|}~). (Alphabets are case-sensitive)

10. Enter the **User Name**

Enter the name that identifies the user.

Register user info

User Name:

1 to 20 characters

Time zone:

(UTC) Coordinated Universal Time ▾

Back Next

»»» Important

- The **User Name** entry field has the following character restrictions:
- The user name must be between 1 and 20 characters long, using single-byte alphanumeric characters and symbols (!"#%&'()*+,-./:;<=>@[^_`{|}~). (Alphabets are case-sensitive)

11. Specify the **Time zone** setting, and select **Next**

Select your region on the list. If you cannot find your region on the list, select the one closest to your region.

Apply daylight saving time

This appears only when there is a daylight saving time in the **Time zone** that you selected.

Select whether or not to apply the daylight saving time.

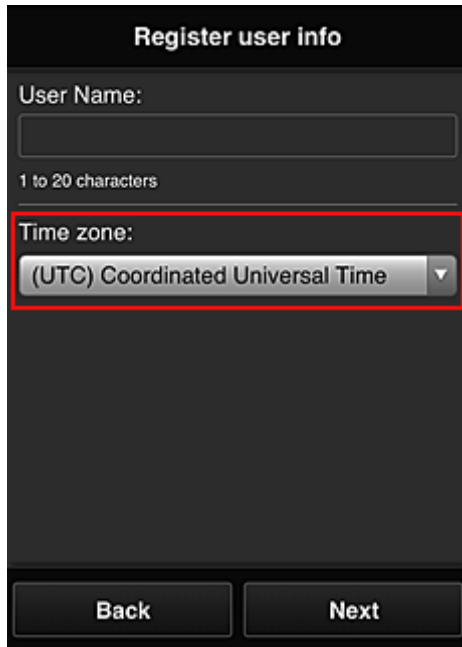

The screenshot shows a dark-themed mobile application interface titled "Register user info". At the top, there is a "User Name:" label followed by a text input field. Below the input field, the text "1 to 20 characters" is displayed. The "Time zone:" label is followed by a dropdown menu currently showing "(UTC) Coordinated Universal Time". This dropdown menu is highlighted with a red rectangular border. At the bottom of the screen, there are two buttons: "Back" on the left and "Next" on the right.

12. Enter the **Security code** and select **Done**

Enter the code for authenticating the user.



The screenshot shows the same "Register user info" screen, but now it is at the "Set security code" step. The text "Set security code." is at the top, followed by a link "[About security code](#)". Below this, there is a "Security code:" label and a text input field. Underneath that is a "Security code (confirmation):" label and another text input field. At the bottom of the input fields, the text "0 to 8 digits" is displayed. At the bottom of the screen, there are two buttons: "Back" on the left and "Done" on the right.

»»» Important

- You can register to this service without setting a **Security code**. However, from the viewpoint of security, we recommend that you set a **Security code**.
- The **Security code** entry field has the following character restrictions:

- Up to 8 single-byte numbers

The registration is complete. A registration completion message is displayed.

When you select the **OK** button in the message, the login screen is displayed.

Enter the registered e-mail address and password, and [log in](#) to the Canon Inkjet Cloud Printing Center.

■ [Using Canon Inkjet Cloud Printing Center](#)

Canon Inkjet Cloud Printing Center window

This section describes the Canon Inkjet Cloud Printing Center screens that are displayed on your smartphone, tablet device, or computer.

- [Description of the Login screen](#)
- [Description of the Main screen](#)

Description of the Login screen

This section provides the description of the Login screen of Canon Inkjet Cloud Printing Center.

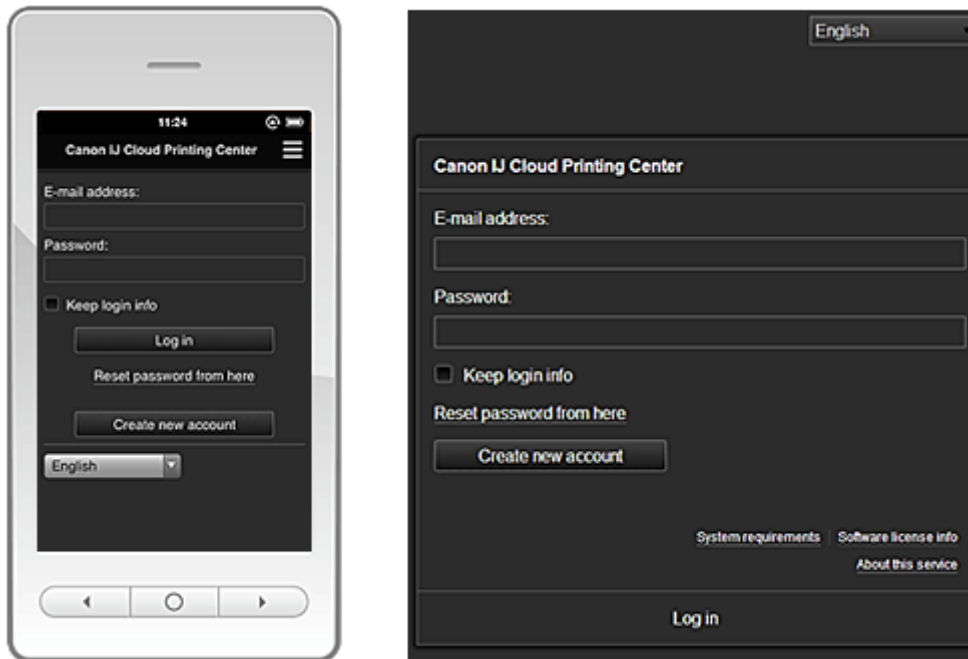

►► Important

- You have 5 tries to enter your password. If you fail, you will not be able to log in for about the next hour.
- You remain logged in for an hour after the last access.

Language

Select the language you will be using.

E-mail address

Enter the e-mail address that you entered in the user registration.

►► Important

- The e-mail address is case-sensitive. Make sure the case is correct.

Password

Enter the password that you entered in the user registration.

Keep login info

When you select the check box, the login screen is skipped for 14 days since the last day that the service screen was accessed.

Reset password from here

Select this if you forgot the password.

Reset your password by following the instructions on the screen.

Create new account

A new registration will be added to the Canon Inkjet Cloud Printing Center.

System requirements

This displays the system requirements for the Canon Inkjet Cloud Printing Center.

Software license info

The licensing information of Canon Inkjet Cloud Printing Center is displayed.

About this service

This displays the descriptions of this service.

Description of the Main screen

When you log in to the Canon Inkjet Cloud Printing Center, the Main screen appears.

►► Important

- With this service, the functions available to [Standard user](#) of the printer are different from those available to the printer [Administrator](#).
Standard user can only use the functions marked by an asterisk (*).

You can use areas shown below to start*, add, and manage apps.

If you are using a smartphone or a tablet, you can also print photos and documents.

■ [If you are using a smartphone or tablet](#)

■ [If you are using a PC](#)

If you are using a smartphone or tablet

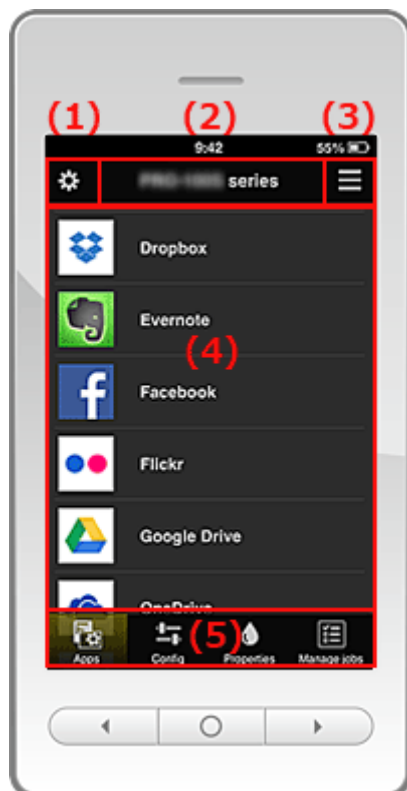

- (1) [Left context menu](#)
- (2) [Printer name area](#)
- (3) [Right context menu](#)
- (4) [Display area](#)

(5) [Menu area](#)

(1) Left context menu

When you select , the **Mng. printer** screen or the **Manage users** screen appears.
For general users, only the **Select printer** screen appears.

Mng. printer screen (Select printer screen)

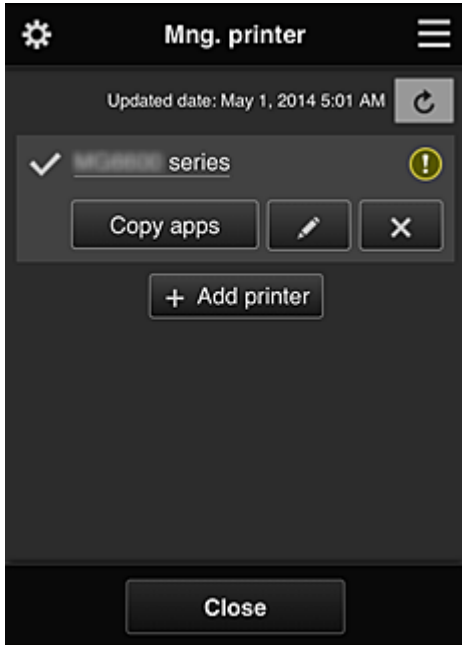

For the Administrator

From the **Mng. printer** screen, you can [check*](#) or [update*](#) printer information registered to the Canon Inkjet Cloud Printing Center, [copy apps](#), [change printer names](#), [delete printers](#), and [add printers](#).

For the Standard user

From the **Select printer** screen, you can [check*](#) or [update*](#) printer information registered to the Canon Inkjet Cloud Printing Center.

- **Check the printer information***

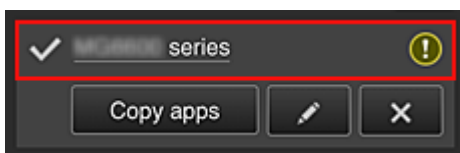

The registered printer name is displayed.

 indicates the currently selected printer.

 indicates that an error occurred on the printer.

- **Display update date/time of the printer information***

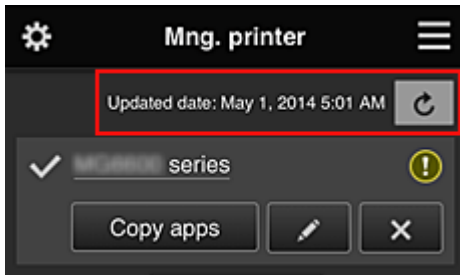

This displays the date and time the printer information was last updated.

 refreshes the information.

- **Copy apps (Administrator only)**

Select this to copy apps added in the selected printer to another printer.

When you select , the screen shown below appears.

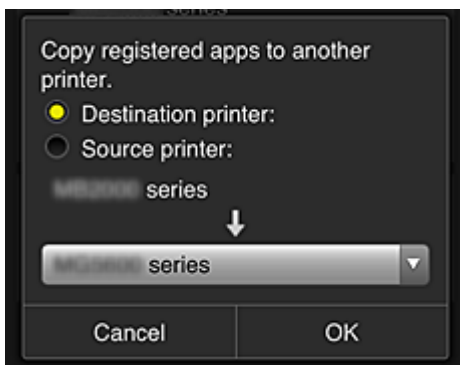

Set the **Destination printer** and the **Source printer**. Then select **OK**.

- **Change the printer name (Administrator only)**

When you select , a screen to change the printer name appears.

Follow the instructions on the screen to change the name.

»»» Important

- The printer name entry has the following character limitation:
 - Up to 128 characters (Uppercase and lowercase letters are differentiated.)

- **Delete printers (Administrator only)**

When you select , the printer is deleted from the Canon Inkjet Cloud Printing Center.

When transferring the ownership of the printer, select **Clear the information saved on the printer**.

- **Add printers (Administrator only)**

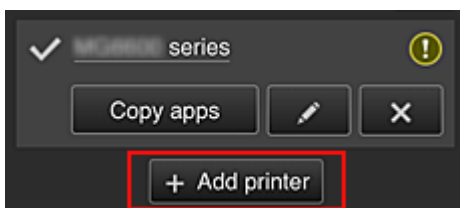

Select this to add printers to be used in the Canon Inkjet Cloud Printing Center.

»» Note

- Although the number of printers that can be registered for one e-mail address is not limited, only up to 16 printers are guaranteed to operate.

Manage users screen

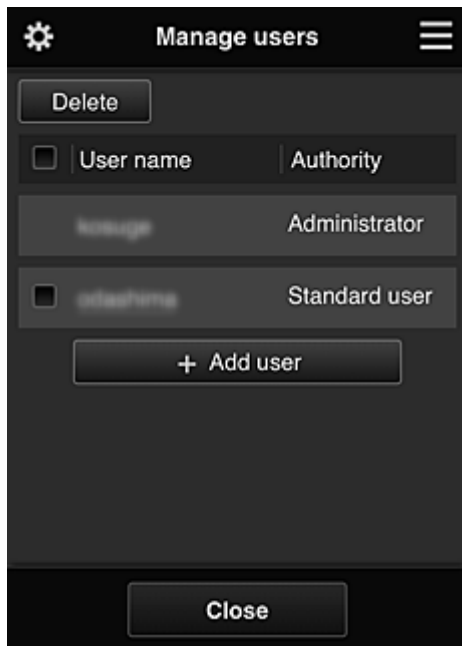

For the Administrator

From the **Manage users** screen, you can check user information registered to the Canon Inkjet Cloud Printing Center, [delete users](#), [add users](#), and [change the Administrator and Standard user settings](#).

- **User deletion (Administrator only)**

Select the check box of the user to be deleted, and select **Delete**.

However, you cannot delete yourself. To delete yourself, cancel your membership from the [user information](#) screen.

- **Adding a user (Administrator only)**

Select **Add user**. The user registration screen appears.

- **Changing Administrator and Standard user settings (Administrator only)**

You can change the privileges of the **Administrator** and **Standard users**.

(2) Printer name area

The registered name of the printer selected is displayed.

The **Administrator** can [change the printer name](#) from the **Mng. printer** screen of the left context menu.

(3) Right context menu

When you select , the context menu appears.

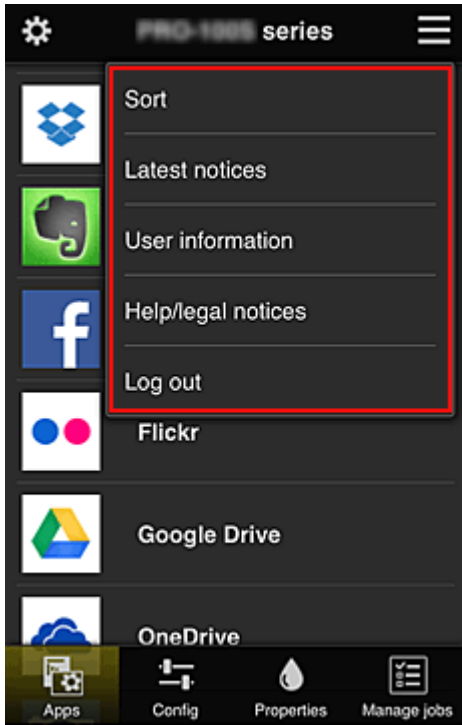

The information displayed depends on the menu currently selected in the menu area.

The  symbol indicates that there is a new unread notice.



- **Sort** **Sort (Administrator only)**

This displays the screen to sort registered apps.

You can use the   buttons to change the display order of apps. When you finish sorting, press the **Done** button to confirm the order.

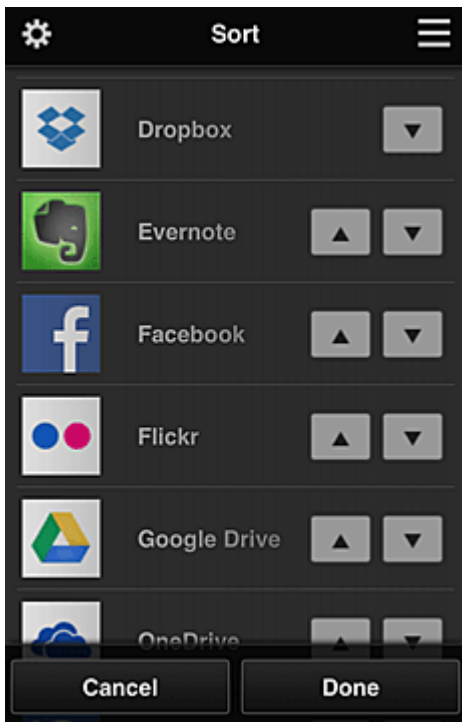

- **Latest notices** **Latest notices***

This displays the latest notices. The  symbol indicates that there is a new unread notice.

- **User information** **User information***

This displays the User information screen.

You can change the registered e-mail address, password, language, time zone, and other settings.

- **Help/legal notices** **Help/legal notices***

The description of the Canon Inkjet Cloud Printing Center screen and various reminders are displayed.

- **Log out** **Log out***

This opens the Log out screen of the Canon Inkjet Cloud Printing Center.

(4) Display area

The display changes based on the menu you select.

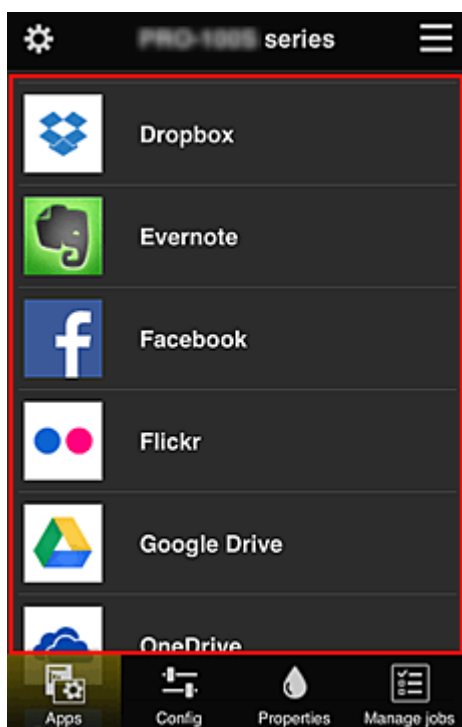

(5) Menu area

The following 4 menu buttons are displayed:

-  **Apps***

This displays the list of registered apps in the [Display area](#).

-  **Config (Administrator only)**

This displays the Register apps screen in the [Display area](#).

The display can be toggled between **Registered** and **Search apps**.

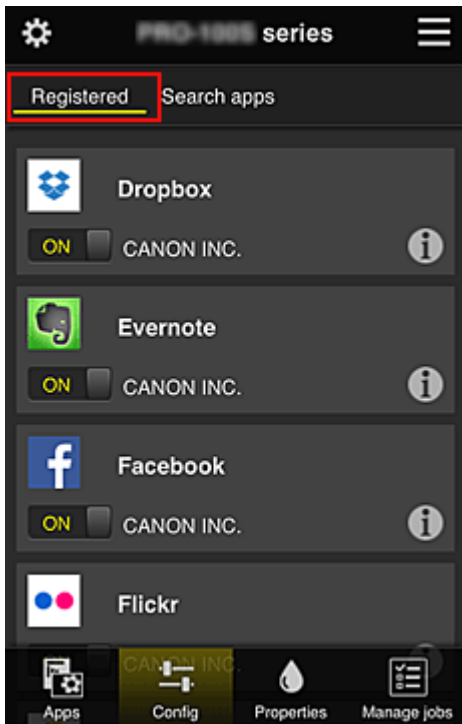

The **Registered** screen lists registered apps.

You can check the information of these apps or deregister them.



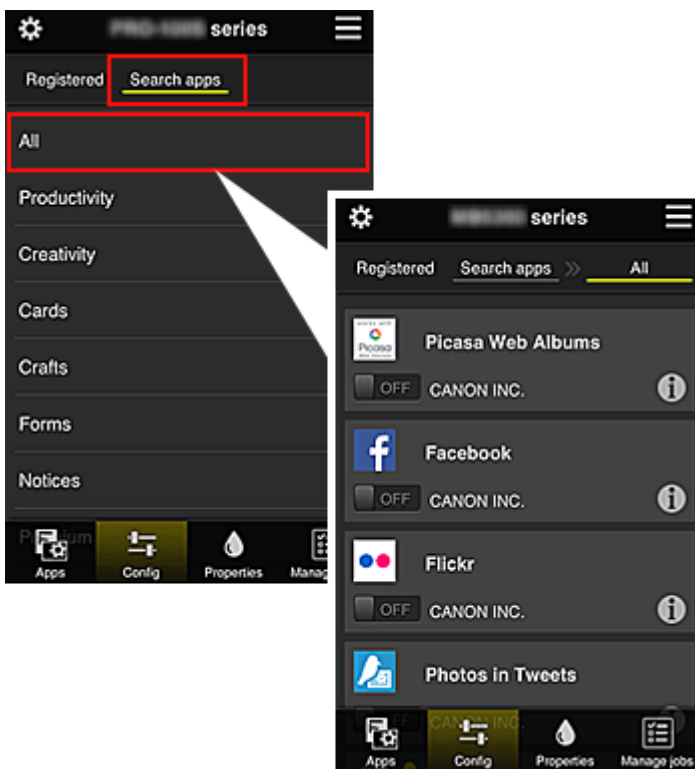

On the **Search apps** screen, the apps that you can register by using the Canon Inkjet Cloud Printing Center are displayed by category.



- When you select , the details of the app are displayed.
- When you select , you can choose to register or unregister the app.

▶▶▶ Note

- Description of displayed icons
 -  : Cannot be used because it is not yet released, not available in your region, or does not support your model.
 -  : Can be used with genuine Canon ink.

- 
Properties*

This screen displays the status of the printer that is currently selected.
 You can check how much ink is remaining or details about an error that occurred. You can also access the ink purchasing site and the *Online Manual*.

Important

- The Properties displayed may differ from the actual status at the display time, depending on the printer status.

- 
Manage jobs*

This screen displays the print status and the print history.
 You can check the print status by looking at **Status list**, and the print history by looking at **History**.
 You can also cancel print jobs and delete history information.
 To cancel or delete a job, select that job and then select **Cancel** or **Delete**.

If you are using a PC

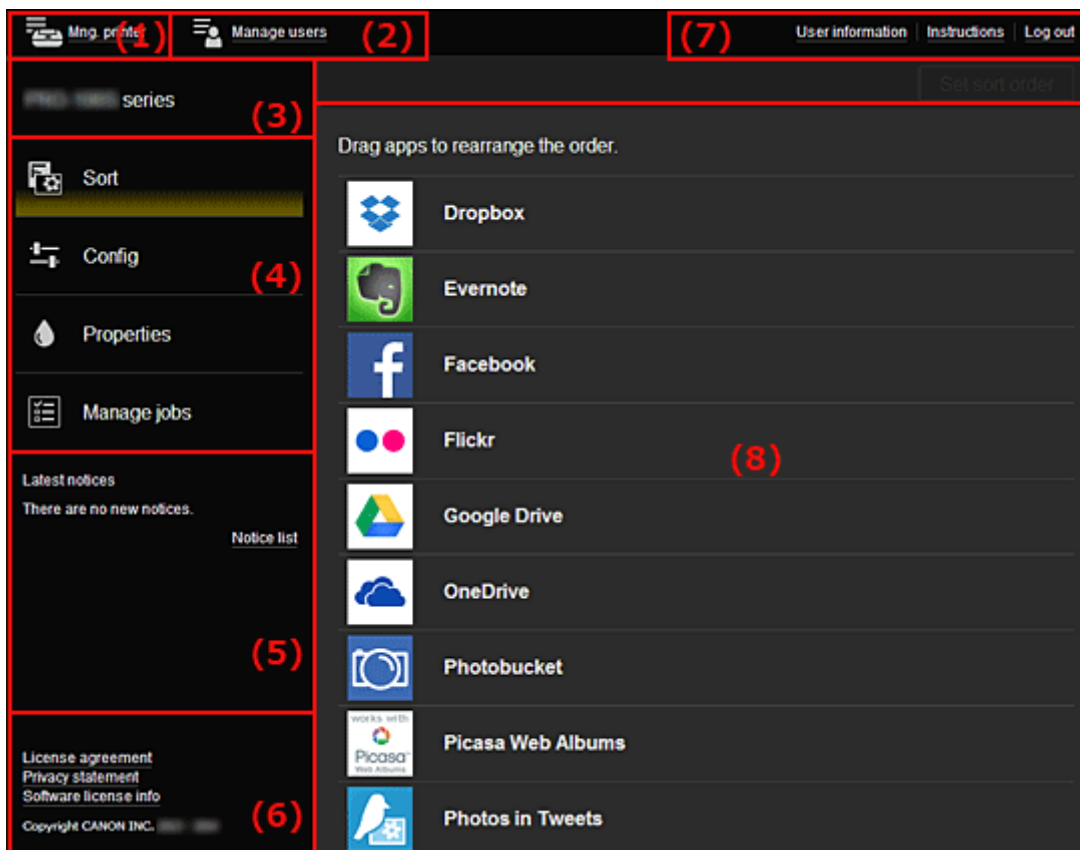

- (1) [Mng. printer \(Select printer\) button](#)
- (2) [Manage users button](#)
- (3) [Printer name area](#)
- (4) [Menu area](#)
- (5) [Notices area](#)
- (6) [Information area](#)
- (7) [Global navigation area](#)
- (8) [Display area](#)

(1) Mng. printer (Select printer) button

When you select the **Mng. printer (Select printer)** button, the **Mng. printer (Select printer)** screen appears.

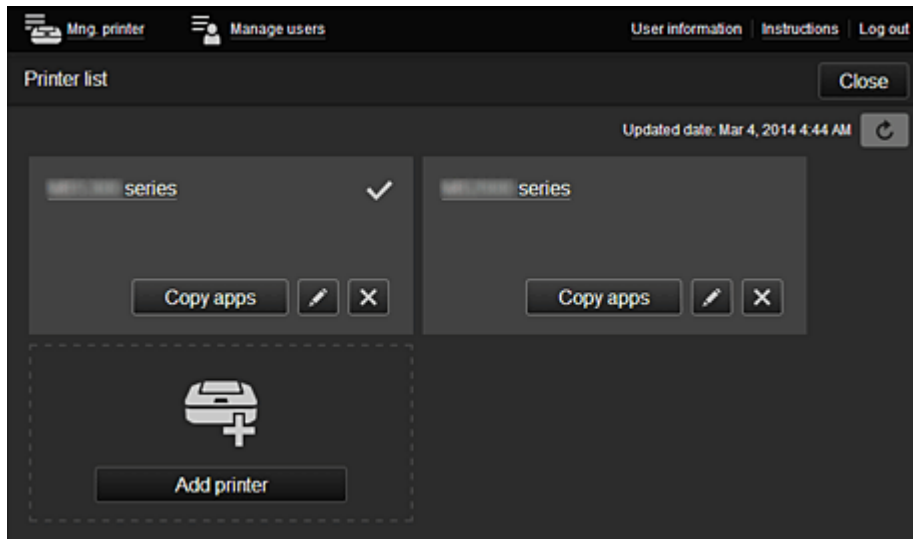

For the Administrator

From the **Mng. printer** screen, you can [check*](#) or [update*](#) printer information registered to the Canon Inkjet Cloud Printing Center, [copy apps](#), [change printer names](#), [delete printers](#), and [add printers](#).

For the Standard user

From the **Select printer** screen, you can [check*](#) or [update*](#) printer information registered to the Canon Inkjet Cloud Printing Center.

- **Check the printer information***

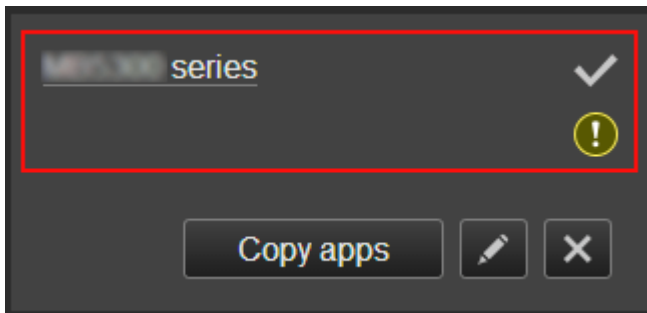

The registered printer name is displayed.

✓ indicates the currently selected printer.

! indicates that an error occurred on the printer.

- **Display update date/time of the printer information***

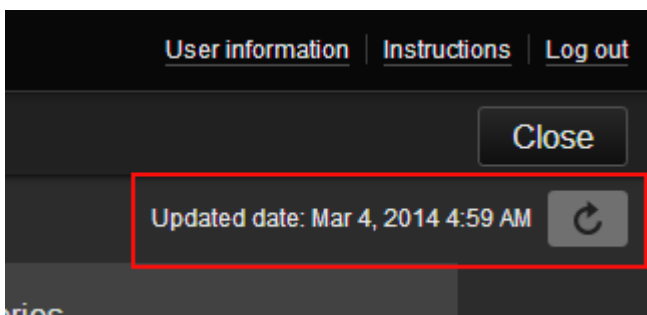

This displays the date and time the printer information was last updated.

 refreshes the information.

- **Copy apps (Administrator only)**

Select this to copy apps added in the selected printer to another printer.

When you select , the screen shown below appears.

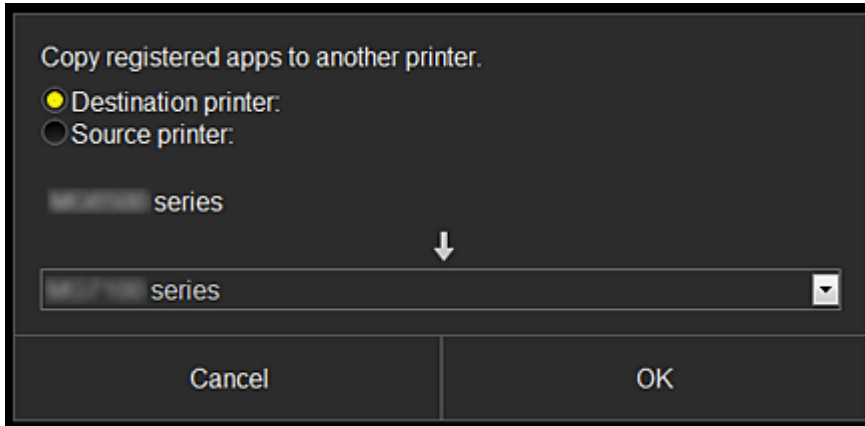

Set the **Destination printer** and the **Source printer**. Then select **OK**.

- **Change the printer name (Administrator only)**

When you select , a screen to change the printer name appears.

Follow the instructions on the screen to change the name.

»» Important

- The printer name entry has the following character limitation:
 - Up to 128 characters (Uppercase and lowercase letters are differentiated.)

- **Delete printers (Administrator only)**

When you select , the printer is deleted from the Canon Inkjet Cloud Printing Center.

When transferring the ownership of the printer, select **Clear the information saved on the printer**.

- **Add printers (Administrator only)**

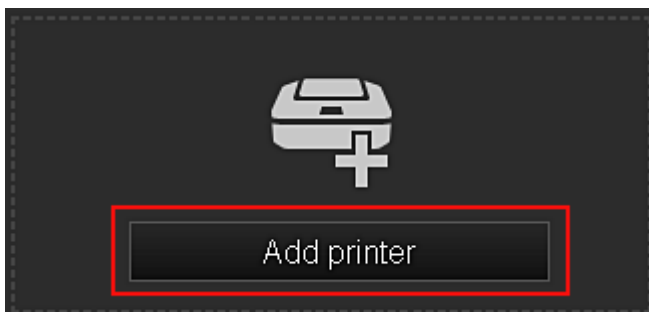

Select this to add printers to be used in the Canon Inkjet Cloud Printing Center.

»» Note

- Although the number of printers that can be registered for one e-mail address is not limited, only up to 16 printers are guaranteed to operate.

(2) Manage users button

When you select the **Manage users** button, the Manage users screen appears.

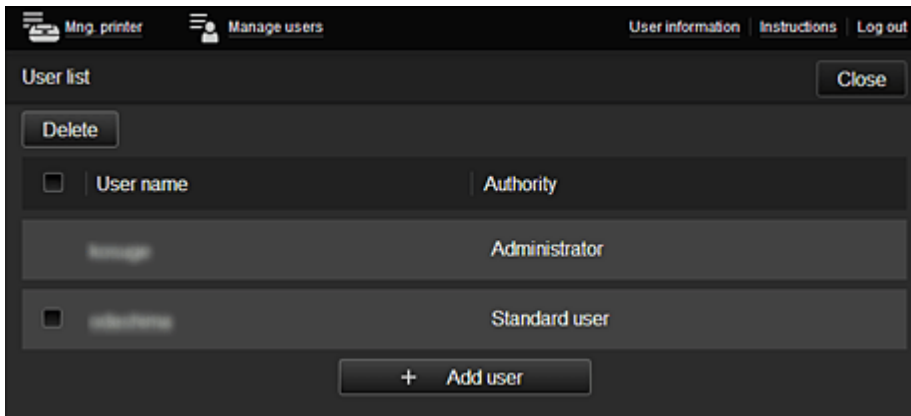

For the Administrator

From the **Manage users** screen, you can check user information registered to the Canon Inkjet Cloud Printing Center, [delete users](#), [add users](#), and [change the Administrator and Standard user settings](#).

- **User deletion (Administrator only)**

Select the check box of the user to be deleted, and select **Delete**.

However, you cannot delete yourself. To delete yourself, cancel your membership from the [user information](#) screen.

- **Adding a user (Administrator only)**

Select **Add user**. The user registration screen appears.

- **Changing Administrator and Standard user settings (Administrator only)**

You can change the privileges of the **Administrator** and **Standard users**.

(3) Printer name area

The registered name of the printer selected is displayed.

The **Administrator** can [change the printer name](#) from the **Mng. printer** screen of the **Mng. printer** button.

(4) Menu area

The following 4 menu buttons are displayed:

-  **Sort (Apps) (Administrator only)**

This displays the list of registered apps in the [Display area](#).

Drag the app to change the order.

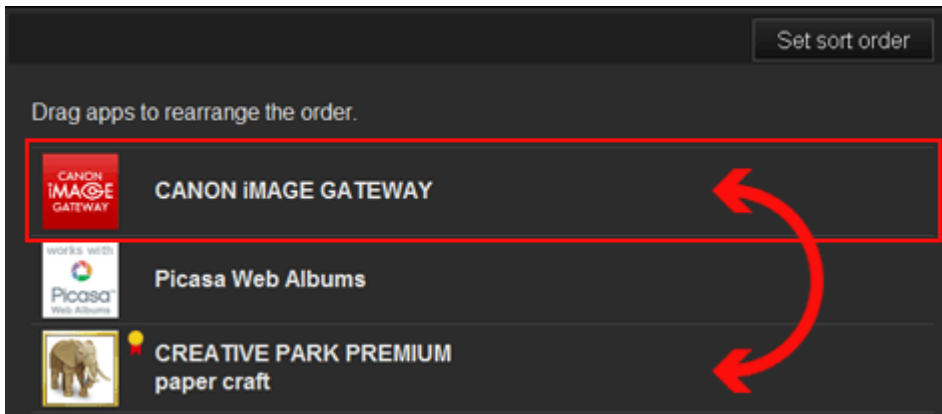

When you finish sorting, press the **Set sort order** button and confirm the order.

- 
Config (Administrator only)

This displays the Register apps screen in the [Display area](#).

The display can be toggled between **Registered** and **Search apps**.

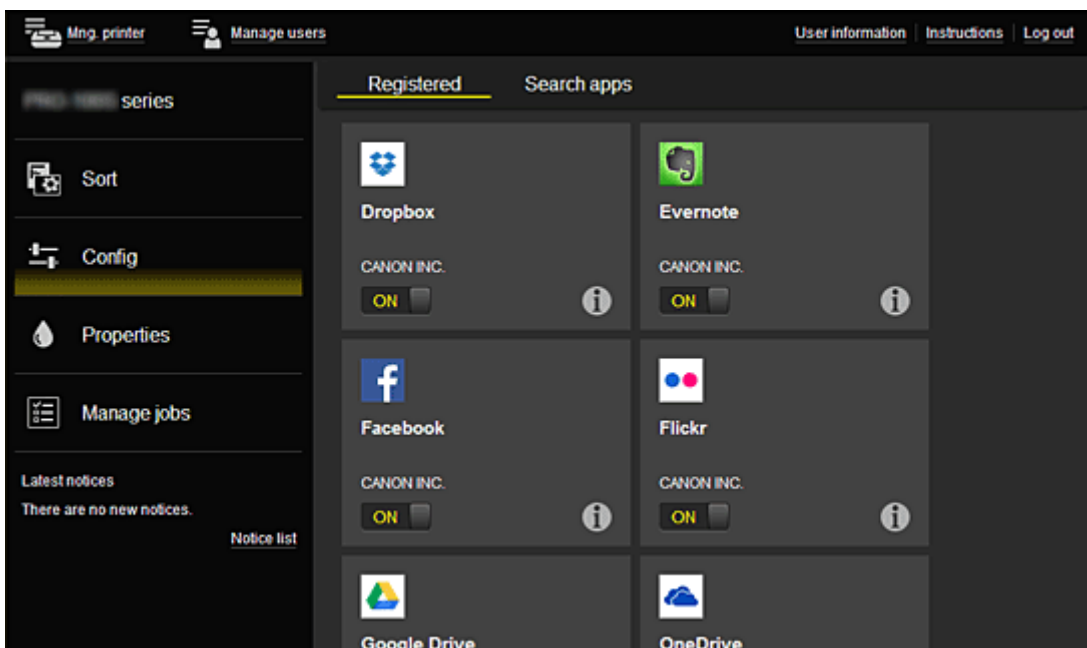

The **Registered** screen lists registered apps.

You can check the information of these apps or deregister them.



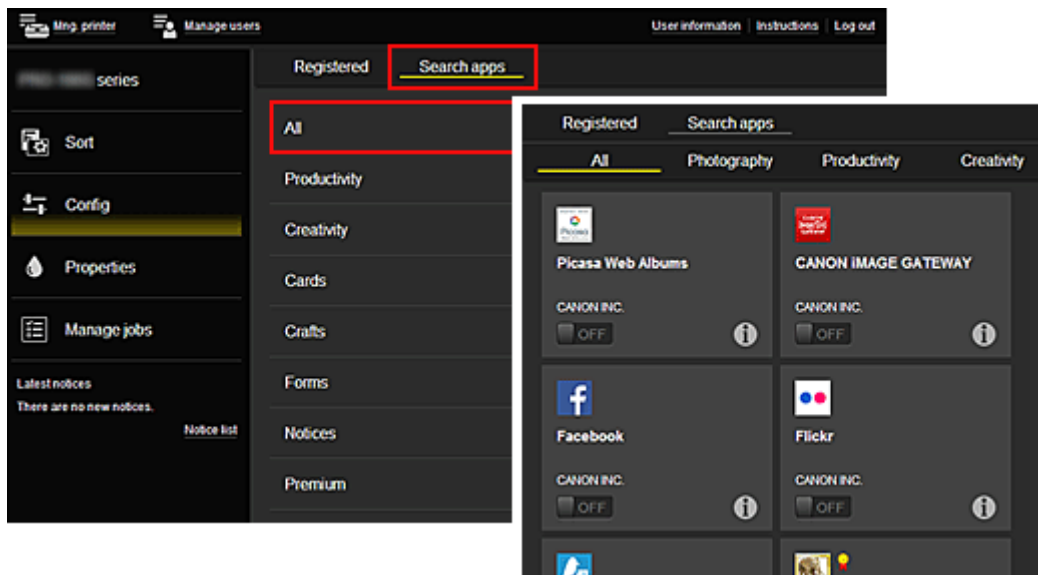

On the **Search apps** screen, the apps that you can register by using the Canon Inkjet Cloud Printing Center are displayed by category.



- When you select , the details of the app are displayed.
- When you select , you can choose to register or unregister the app.

»»» Note

- Description of displayed icons
 -  : Cannot be used because it is not yet released, not available in your region, or does not support your model.
 -  : Can be used with genuine Canon ink.



Properties*

This screen displays the status of the printer that is currently selected. You can check how much ink is remaining or details about an error that occurred. You can also access the ink purchasing site and the *Online Manual*.

»»» Important

- The Properties displayed may differ from the actual status at the display time, depending on the printer status.

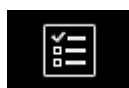

Manage jobs*

This screen displays the print status and the print history. You can check the print status by looking at **Status list**, and the print history by looking at **History**. You can also cancel print jobs and delete history information. To cancel or delete a job, select that job and then select **Cancel** or **Delete**.

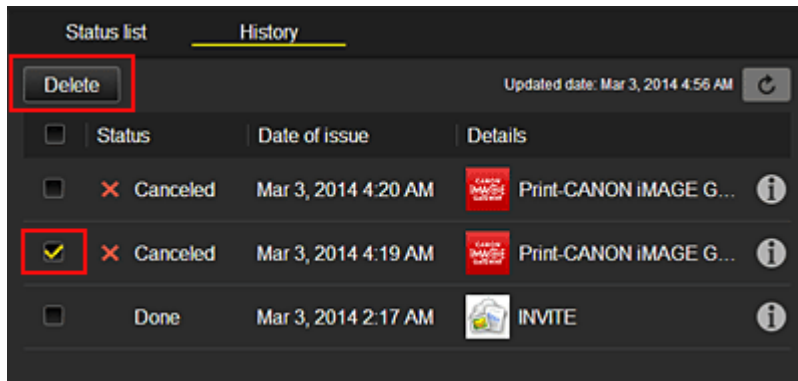

(5) Notices area

This displays the latest notice. Nothing is displayed in this area if there is no notice. When you select **Notice list**, you can display up to 40 items.

(6) Information area

This display other information, including the privacy statement and other companies' licensing information.

(7) Global navigation area

The **User information***, **Instructions***, and **Log out*** buttons are displayed. Press the **User information** to change the settings.

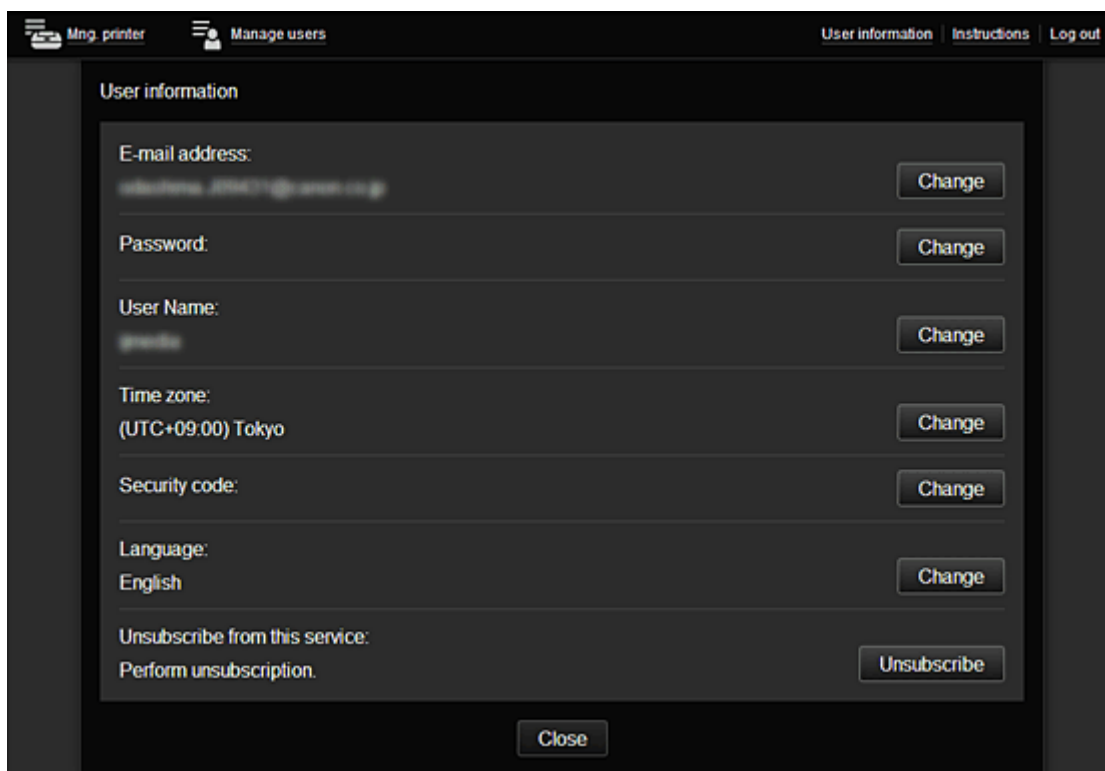

(8) Display area

The display changes based on the menu you select.

Mng. printer Manage users User information Instructions Log out

series [Set sort order](#)

Sort

Config









Properties

Manage jobs

Latest notices
There are no new notices.
[Notice list](#)

License agreement
Privacy statement
Software license info
Copyright CANON INC.

Drag apps to rearrange the order.

-  Dropbox
-  Evernote
-  Facebook
-  Flickr
-  Google Drive
-  OneDrive
-  Photobucket
-  Picasa Web Albums
-  Photos in Tweets

Using Canon Inkjet Cloud Printing Center

When the user registration is completed, you can log in to the Canon Inkjet Cloud Printing Center and use the service.

1. From your PC, smartphone, or tablet, access the service login URL (<http://cs.c-ij.com/>)
2. On the Login screen, enter the **E-mail address** and **Password**, and then select **Log in**

▶▶▶ Important

- The e-mail address and password are case-sensitive. Make sure the case is correct.

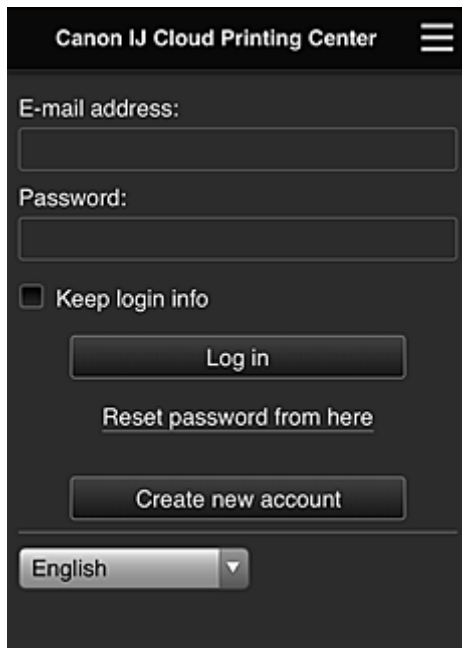

E-mail address

Enter the e-mail address that you entered in the user registration.

Password

Enter the password that you entered in the user registration.

Keep login info

When you select the check box, the login screen is skipped for 14 days since the last day that the service screen was accessed.

▶▶▶ Important

- If you fail to log in five straight times, you will not be able to login again for an hour.
- You remain logged in for an hour after the last access.
- The service may not function properly if you log in from multiple devices at the same time.

After logging in, you can use useful services such as adding/managing apps that work in conjunction with this product's cloud functionality and checking the ink status.

For screen descriptions and operation instructions, see "[Canon Inkjet Cloud Printing Center window](#)".

Printing procedure

This section introduces the photo printing procedure by using CANON IMAGE GATEWAY as an example.

▶▶▶ Important

- The available functions differ depending on the app.
- The printing procedure differs depending on the app.
- You need to get the account and register photo and other data beforehand.
- The following file formats can be printed: jpg, jpeg, pdf, docx, doc, xlsx, xls, pptx, ppt, and rtf.
The file formats that can be printed differ depending on the app.
- Before you print, check that printer is on and is connected to the network. Then start.
- This is available if you are using a smartphone or tablet.

▶▶▶ Note

- You can use CANON IMAGE GATEWAY to print jpg and jpeg file formats.

1. On the Main screen, select the app to be used
2. Enter the information according to the instructions on the authentication screen, and then select **Log in**

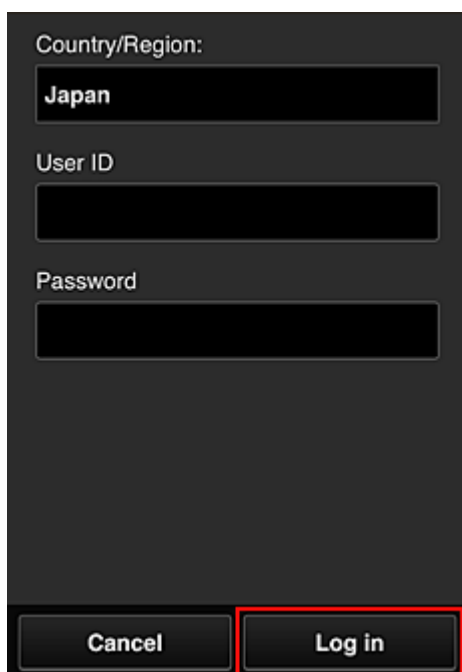

The image shows a dark-themed authentication screen. At the top, it says "Country/Region:" followed by a dropdown menu showing "Japan". Below that is a "User ID" field, which is currently empty. Underneath is a "Password" field, also empty. At the bottom of the screen, there are two buttons: "Cancel" on the left and "Log in" on the right. The "Log in" button is highlighted with a red rectangular border.

3. In the displayed album list, select the album of your choice

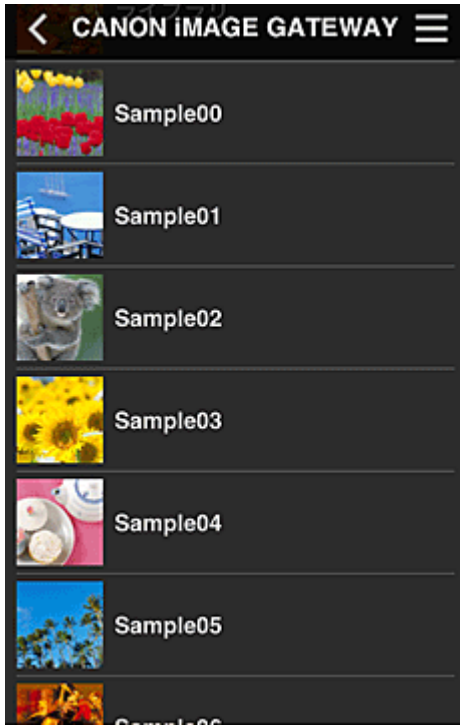

4. In the displayed image list, select the image that you want to print, and then select **Next**



5. Make the necessary print settings, and then select **Print**

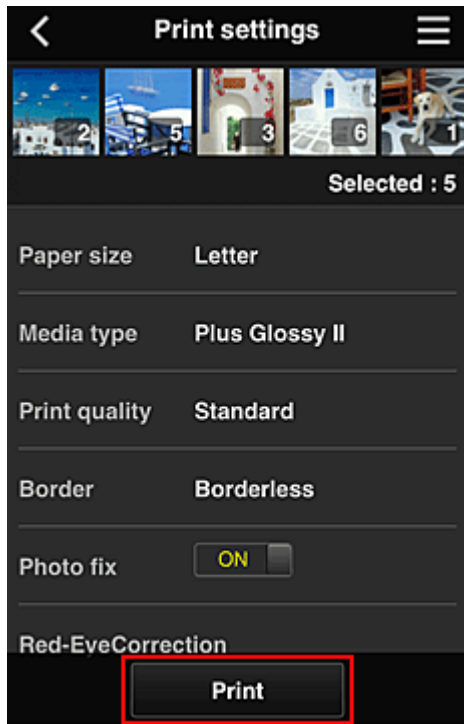

6. A print job completion message appears, and printing starts

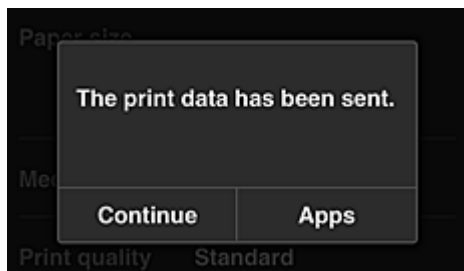

To continue printing, select **Continue**, and perform the operation from Step 3.
To end the printing, select **Apps**. The screen returns to the apps list screen.

»» Important

- If a print job is not printed within 24 hours after the print job is issued, the print job will expire and cannot be printed.
- With premium apps that limit the number of print jobs, print jobs that expire and cannot be printed are also included in the print count.

■ [Adding a Printer](#)

Adding a Printer

With one account, you can use the Canon Inkjet Cloud Printing Center services on multiple printers.

The procedure for adding a printer is as follows:

1. Check that the printer is connected to the Internet

▶▶▶ Important

- To use this function, you must connect this printer to the Internet.

2. [Displaying Printer Information](#)
3. Select **IJ Cloud Printing Center setup -> Register with this service**
4. Follow the instructions displayed in the window, and run the authentication
5. When the printer registration screen is displayed, select **Add printer**

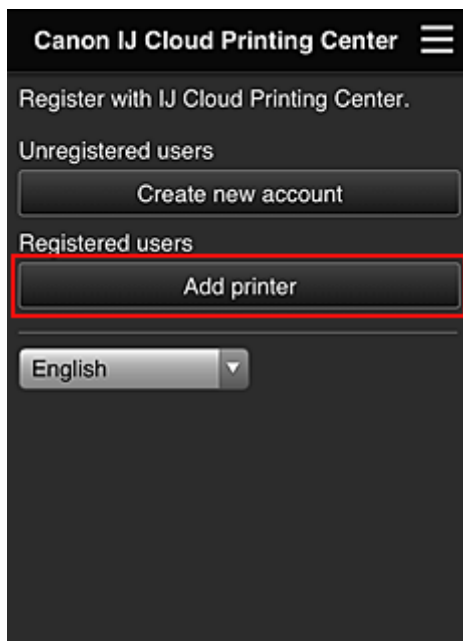

6. Enter the information according to the instructions on the authentication screen, and then select **Log in**
7. When the confirmation message is displayed, select **OK**
Printer addition is completed.

■ [Adding a PIXMA Cloud Link User](#)

Adding a PIXMA Cloud Link User

Several people can use one printer.

This section describes the user addition procedure and the user privileges.

Adding a user

1. On the service screen, select **Manage users**

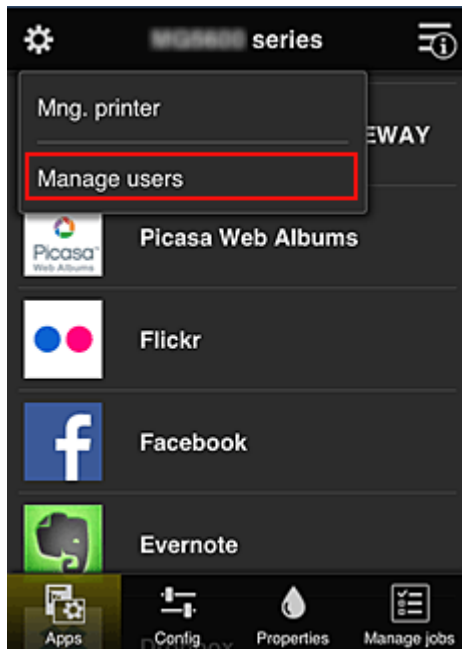

2. Select **Add user**

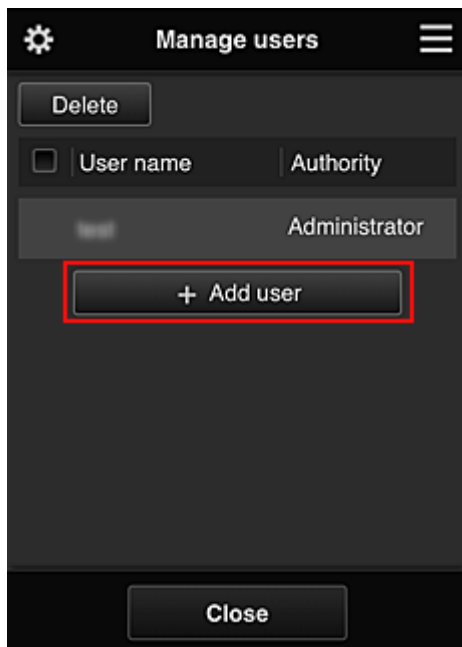

▶▶▶ Note

- When you select **Add user**, the service first checks whether the maximum number of users has been reached. If new users can be added, the user registration screen appears.
- The maximum number of users that can be added for 1 printer is 20.

3. Enter the e-mail address of the user to be added, and then select **OK**

The URL for completing the registration is then sent to the entered e-mail address.

4. Access the URL reported in the e-mail

5. Read the terms displayed in the **License agreement** and **Privacy statement** screens. If you agree to the terms, select **Agree**.

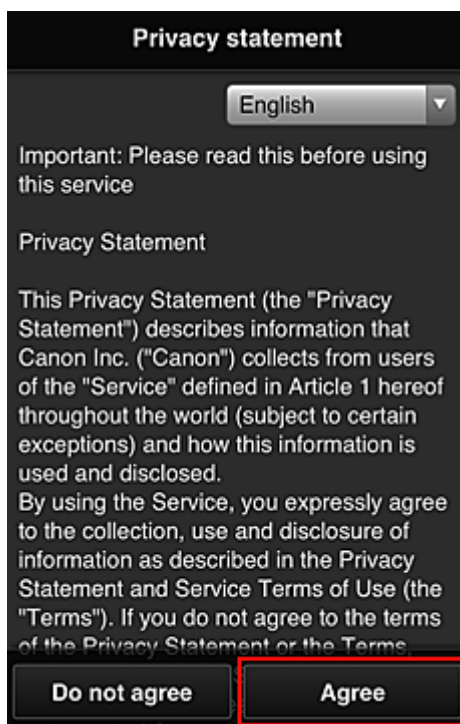
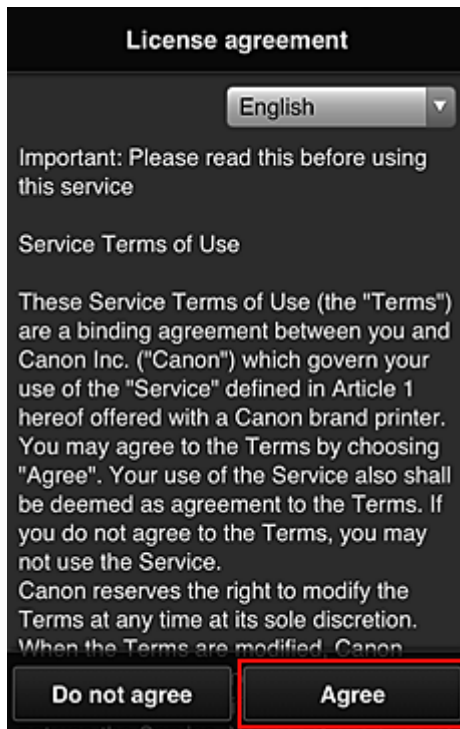

6. In the user information entry screen, enter your **Password**, and select **Next**

Enter your password for logging in to the Canon Inkjet Cloud Printing Center.

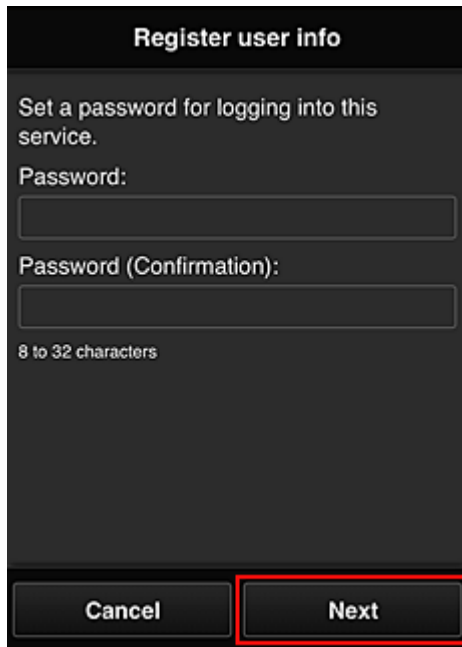

The screenshot shows a dark-themed interface titled "Register user info". Below the title, it says "Set a password for logging into this service." There are two input fields: "Password:" and "Password (Confirmation):". Below the second field, it says "8 to 32 characters". At the bottom, there are two buttons: "Cancel" and "Next". The "Next" button is highlighted with a red border.

»» Important

- There are character restrictions for the **Password**, as shown below.
 - The password must be between 8 and 32 characters long, using single-byte alphanumeric characters and symbols (!"#\$%&'()*+,-./:;<=>@[\\]^_`{|}~). (Alphabets are case-sensitive)

7. Enter the **User Name**

Enter the name that identifies the user.

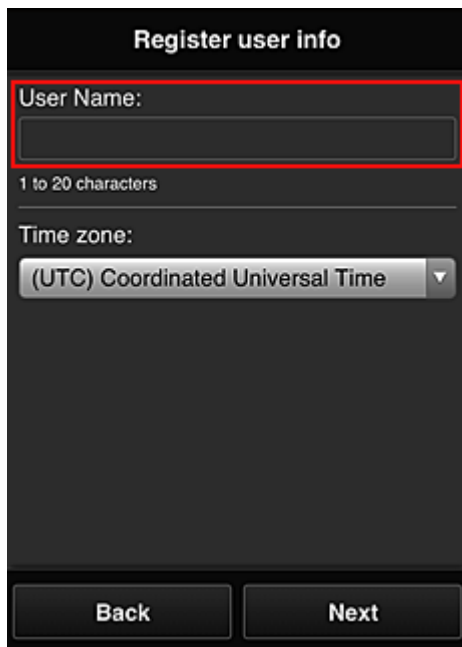

The screenshot shows the same "Register user info" screen. The "User Name:" field is highlighted with a red border. Below it, it says "1 to 20 characters". Below that is a "Time zone:" dropdown menu with "(UTC) Coordinated Universal Time" selected. At the bottom, there are two buttons: "Back" and "Next".

»» Important

- The **User Name** entry field has the following character restrictions:
 - The user name must be between 1 and 20 characters long, using single-byte alphanumeric characters and symbols (!"#\$%&'()*+,-./:;<=>@[\\]^_`{|}~). (Alphabets are case-sensitive)

8. Specify the **Time zone** setting, and select **Next**

Select your region on the list. If you cannot find your region on the list, select the one closest to your region.

Apply daylight saving time

This appears only when there is a daylight saving time in the **Time zone** that you selected. Select whether or not to apply the daylight saving time.

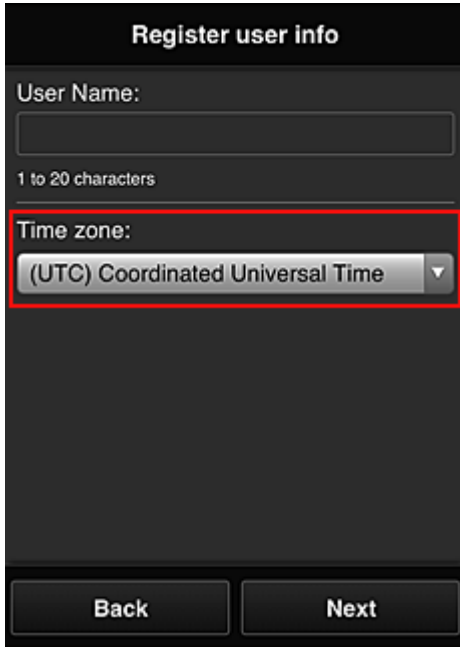

The screenshot shows a mobile application screen titled "Register user info". It features a "User Name:" label above a text input field with a character count "1 to 20 characters" below it. Below the text field is a "Time zone:" label above a dropdown menu. The dropdown menu is open, showing the selected option "(UTC) Coordinated Universal Time" with a downward arrow. At the bottom of the screen are two buttons: "Back" and "Next". A red rectangular box highlights the "Time zone:" label and the dropdown menu.

9. Enter the **Security code** and select **Done**

Enter the code for authenticating the user.



The screenshot shows a mobile application screen titled "Register user info". It features the text "Set security code." followed by a link "[About security code](#)". Below this is a "Security code:" label above a text input field. Underneath is a "Security code (confirmation):" label above another text input field. A character count "0 to 8 digits" is displayed below the second input field. At the bottom of the screen are two buttons: "Back" and "Done".

Important

- You can register to this service without setting a **Security code**. However, from the viewpoint of security, we recommend that you set a **Security code**.
- The **Security code** entry field has the following character restrictions:

- Up to 8 single-byte numbers

The main registration is complete, and a registration completion e-mail is sent.

▶▶ Note

- A cookie for the selected user is added to the printer, and the login status of each user is recovered. Cookies for up to 8 users can be registered to 1 printer.

Printer user privileges

If several users are using the cloud service for 1 printer, each user is categorized as the **Administrator** or a **Standard user**.

▶▶ Note

- The user who is registered first becomes the **Administrator**. The administrator can change the privileges of users from the [Manage users screen](#).

An **Administrator** can change printer information, add and delete apps, manage users, and perform various other operations.

A **Standard user** can check printer information and start apps.

For information about the functions that each user can use, refer to the "[Canon Inkjet Cloud Printing Center window](#)".

■ [Troubleshooting Canon Inkjet Cloud Printing Center](#)

Troubleshooting Canon Inkjet Cloud Printing Center

- [If an app cannot be installed](#)
- [If the registered app is not in the Apps list](#)
- [If the information is not updated when you press the **Update** button](#)
- [If you do not receive the registration e-mail](#)
- [If you cannot print](#)
- [Printing starts on its own even if you do not do anything](#)
- [If you are unable to log in correctly even after entering the correct password in iOS or Mac](#)

If an app cannot be installed

Check the country or region where the printer was purchased.

If the printer is taken outside the country or region where it was purchased, apps cannot be installed.

If the registered app is not in the Apps list

Check the display language of Canon Inkjet Cloud Printing Center.

If the display language is switched to a language that does not support an app, the app will not be displayed in the apps list but will continue to be registered.

If you switch back to the target language of the app, it will be displayed in the apps list and you will be able to start, register, or unregister the app.

If the information is not updated when you press the Update button

Because the Properties screen requires network connection with this product, the information may not be reflected immediately. Please wait awhile, and then try updating the information again.

If the information is still not updated, then check that the product is connected to the Internet.

If you do not receive the registration e-mail

You may have entered a different e-mail address during the user registration of Canon Inkjet Cloud Printing Center.

[Displaying Printer Information](#) -> **IJ Cloud Printing Center setup** -> **Delete from this service** to delete the service registration.

After resetting the printer, repeat the user registration of Canon Inkjet Cloud Printing Center from the beginning.

If you cannot print

Check the following if you cannot print.

- Check that the printer is connected to the Internet.
- Check that the printer is connected to a LAN and the LAN environment is connected to the Internet.
- If printing does not start even after you wait awhile, first turn off the printer, and then turn it back on again.

If the problem is not resolved, use the printer driver from your computer to perform the print job and check whether the data can be printed normally on the printer.

If you still cannot print, see the troubleshooting page for your model on the Home of the *Online Manual*.

▶▶▶ Note

- With a wireless LAN connection, after the printer is turned on, it may take several minutes before communication is possible. Check that your printer is connected to the wireless network, and wait a while before you start printing.
- If the printer is not turned on or is not connected to the Internet, and consequently a print job is not processed within 24 hours after it was submitted, the print job is automatically canceled. If this happens, check the printer power and the Internet connection, and then re-submit the print job.

Printing starts on its own even if you do not do anything

A third party may be able to illegally use the Canon Inkjet Cloud Printing Center services.

[Displaying Printer Information](#) -> **IJ Cloud Printing Center setup** -> **Delete from this service** to delete the service registration.

After resetting the printer, repeat the user registration of Canon Inkjet Cloud Printing Center from the beginning.

If you are unable to log in correctly even after entering the correct password in iOS or Mac

If you are using iOS or Mac and the password contains the ¥ or ₩ symbol, enter a backslash instead. For instructions on entering a backslash, see the OS help.

Printing from AirPrint Compliant Device

This document explains how to use AirPrint to print wirelessly from your iPad, iPhone and iPod touch to a Canon printer.

AirPrint enables you to print photos, email, Web pages and documents from your Apple device directly to your printer without installing a driver.



Checking Your Environment

First, check your environment.

- **AirPrint Operation Environment**

To use AirPrint, you will need one of the following Apple devices running the latest version of iOS:

- iPad (all models)
- iPhone (3GS or later)
- iPod touch (3rd generation or later)

- **Network Environment**

The Apple device (iPad, iPhone, or iPod touch) and this printer must be connected to the same Wi-Fi network or connected in AP mode.

►► Note

- If your iPad, iPhone or iPod touch is running the latest version of iOS, you do not need to download and install any drivers or additional software.

Printing with AirPrint

1. Check that this printer is turned on and the Apple device and this printer is connected to the LAN or connected in AP mode.
2. From the app of your Apple device, tap the operation icon to display the menu options.

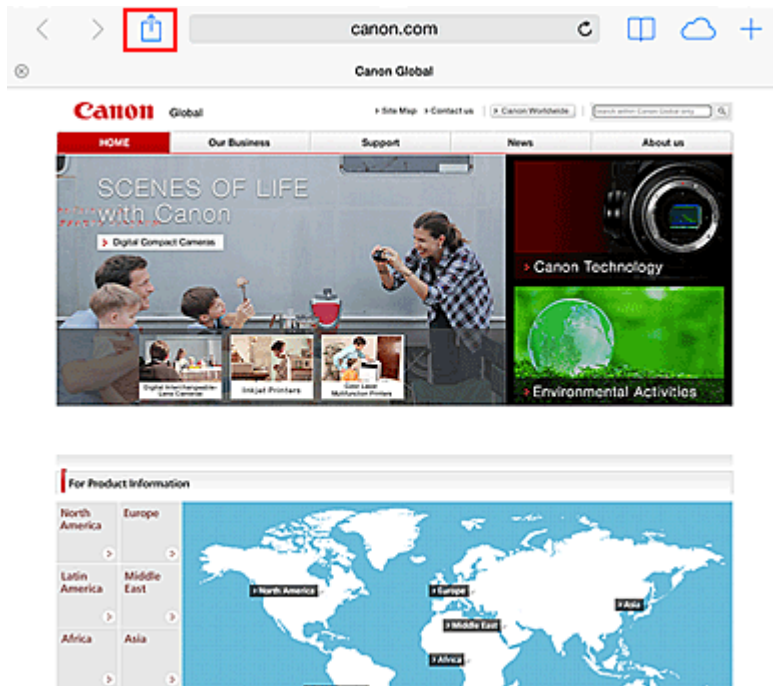

3. From the menu options, tap **Print**.

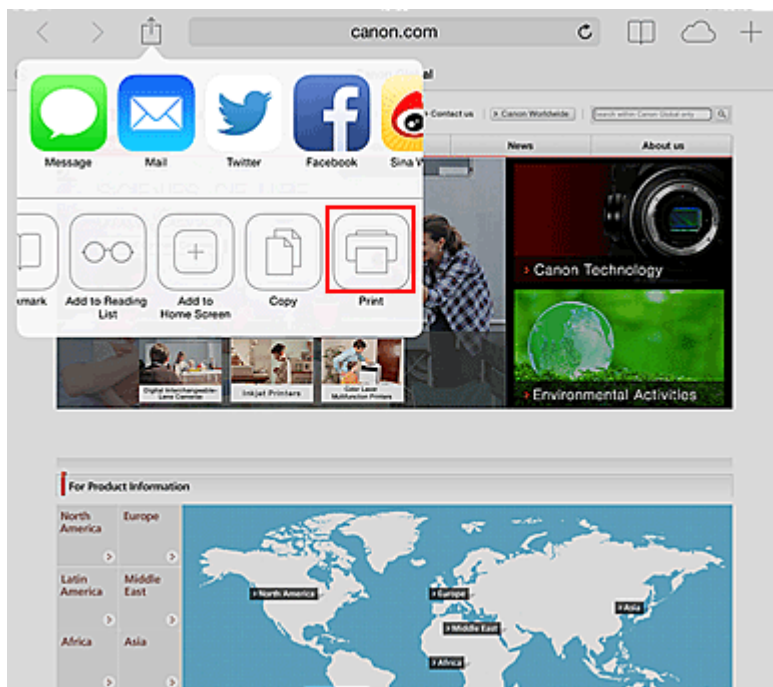

4. From **Printer Options**, select the model that you are using.

»»» Important

- Because some app does not support AirPrint, **Printer Options** may not be displayed. If an app does not let you use printer options, you cannot print from that app.

»»» Note

- The **Printer Options** differ depending on the app and model you are using.

5. When printing a file type that has multiple pages, such as a PDF file, click **Range** and then click **All Pages** or select the range of pages to be printed.
6. For **1 Copy**, click **+** or **-** to set the number of required copies.
7. For **Duplex Printing**, click **On** to enable duplex printing or click **Off** to disable the function.
8. Tap the **Print**.

When you execute printing, the printer prints according to the specified settings.

Paper Size

With AirPrint, the paper size is selected automatically according to the app being used on the Apple device and the region in which AirPrint is used.

When Apple's photo app is used, the default paper size is L size in Japan, and 4"x6" or KG in other countries and regions.

When documents are printed from Apple's Safari app, the default paper size is letter size in the U.S. region, and A4 in Japan and Europe.

»» Important

- Your app may support different paper sizes.

Checking the Print Status

During printing, a **Print Center** icon is displayed in the list of recently used apps, and you can use it to check the print progress.

Press the **Home** button on the Apple device twice to set the **Multitasking** mode. Then swipe to the right to display the **Print Center** icon and a **Print Summary**.

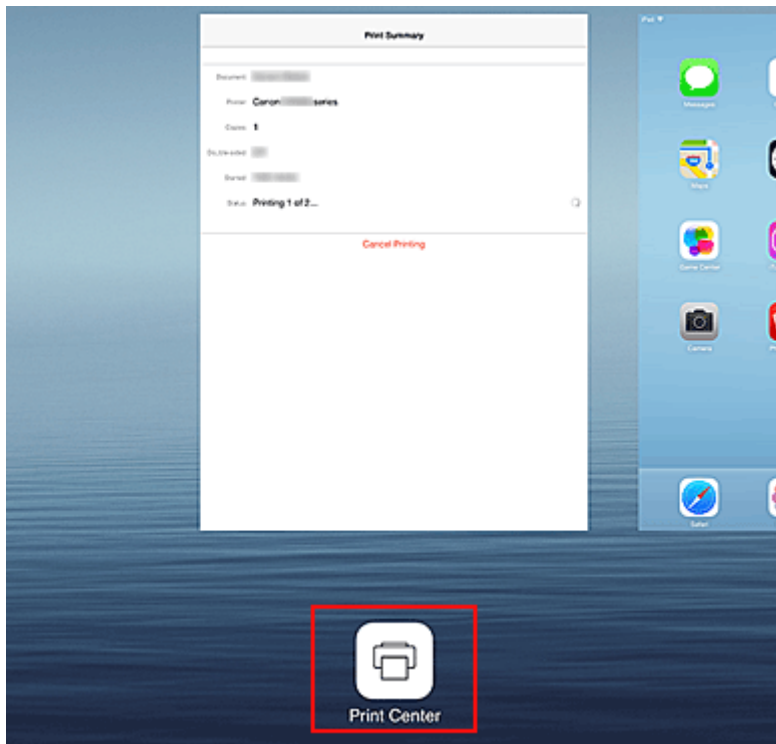

Deleting a Print Job

To delete a print job with AirPrint, use one of the following two methods:

- From the printer: Press the **RESUME** button on the printer to cancel the print job.
- From an Apple device: Press the **Home** button on the Apple device twice to set the **Multitasking** mode, and then swipe to the right. Tap the **Print Center** icon to display a **Print Summary**. Tap the print job to be canceled, and then tap **Cancel Printing**.

AirPrint Troubleshooting

If the document does not print, check the following:

1. Check that the printer power is on. If the printer power is on, turn it off and then back on again, and check whether the issue is resolved.
2. Check that the printer is connected by LAN to the same network subnet as the device on which iOS is installed.
3. Check that the printer has enough paper and ink.

If the problem persists, use the printer driver on your computer to execute printing and check whether the document can be printed normally on the printer.

If the document cannot be printed, refer to the *Online Manual* for your model.

►► Note

- After you turn on the printer, it may take few minutes before the printer can communicate through a wireless LAN connection. Confirm that the printer is connected to the wireless LAN, and then try printing.
- If Bonjour on the printer is disabled, AirPrint cannot be used. Check the LAN settings on the printer, and enable Bonjour.

»» Note

- The windows used in the explanations may differ from those displayed by your Apple device or app.

Checking Printer Information

You can use your smartphone, tablet, or computer to check the **Printer status** and execute utility functions from apps such as Canon Inkjet Print Utility and PIXMA Printing Solutions.

You can also use the convenient web services presented by Canon.

1. Selecting Printer Information in an Apps Screen

▶▶▶ Note

- You can also enter IPv4 address directly in the web browser to display printer information.
 1. Check that the printer has been turned on
 2. Load one sheet of A4 size or Letter size plain paper
 3. Hold down the **RESUME** button until the **POWER** lamp flashes 6 times
 4. Release the buttonPrinting of the network setup information starts. Check the IPv4 address that was printed.
- 5. Check that the printer is connected to the same Wi-Fi network. Then from your smartphone, tablet device, or computer, open the Web browser, and enter the following URL:
`http:// <Printer IPv4 address>`
For <Printer IPv4 address>, enter the IPv4 address that you checked in the previous procedure. Entries enclosed in brackets are not required.

2. Entering **Username** and Administrator's Password

From the authentication screen, enter the **Username** and **Password**.

Username: ADMIN

Password: See "[About the Administrator Password](#)."

▶▶▶ Note

- The **Username** display may differ depending on your browser.

3. Displaying Printer Information

The top screen for printer information is displayed.

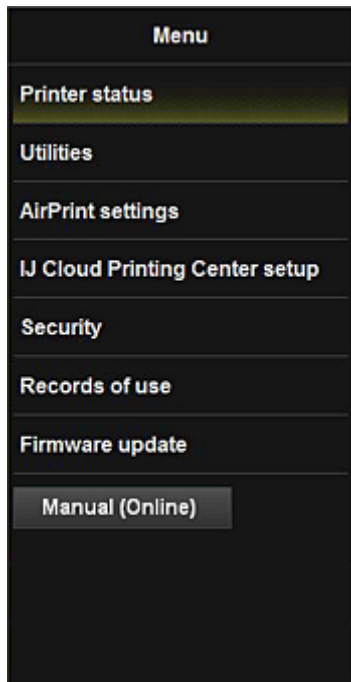

Printer status

This function displays printer information such as the remaining ink amount, the status, and detailed error information.

You can also connect to the ink purchase site or support page, and use Web Services.

Utilities

This function allows you to set and execute the printer utility functions such as cleaning.

AirPrint settings

This function allows you to specify the Apple AirPrint settings, such as position information.

IJ Cloud Printing Center setup

Allows you to register to IJ Cloud Printing Center or to delete a registration.

Security

Allows you to set the **Administrator's** password and **Operation restrictions** for the machine.

»» Important

- For the initial **Password**, see "[About the Administrator Password.](#)"
For Security reasons, we recommend that you change the **Password** to an individual password.
- There are character restrictions for the password, as shown below.
 - Up to 32 single-byte alphanumeric characters. (Uppercase and lowercase letters are differentiated.)

Records of use

Displays a record of your printer usage, such as the number of pages printed.

Firmware update

This function allows you to update the firmware and check version information.

Manual (Online)

This function displays the *Online Manual*.

Print Easily from a Smartphone or Tablet with PIXMA Printing Solutions

Use PIXMA Printing Solutions to easily print photos saved on a smartphone or tablet wirelessly.

PIXMA Printing Solutions can be downloaded from App Store and Google Play.



Printing with Windows RT

When you use Windows RT 8.1 or a later version, printing is easy because you simply connect this printer to the network.

For information about connecting to the network, see the setup URL (<http://www.canon.com/ijsetup>) for using this product from your computer, smartphone, or tablet device.

When the connection is complete, the Canon Inkjet Print Utility software, which allows you to specify detailed print settings, is downloaded automatically.

By using Canon Inkjet Print Utility, you can check the **Printer status** and specify detailed print settings. (The available functions will differ depending on your usage environment and connection method.)

Overview of the Printer

▶ **Safety Guide**

- Safety Precautions
- Regulatory and Safety Information

▶ **Main Components and Basic Operations**

- Main Components
- About the Power Supply of the Printer

▶ **Loading Paper**

- Loading Paper
- Placing a Printable Disc

▶ **Replacing an Ink Tank**

- Replacing an Ink Tank
- Checking the Ink Status

▶ **Maintenance**

- When Printing Becomes Faint or Colors Are Incorrect
- Performing Maintenance from a Computer
- Cleaning the Printer

▶ **Changing the Printer Settings**

- Changing Printer Settings from Your Computer
- Initializing the Printer Settings
- Disabling the LAN Function of the Printer

▶ **Information about Network Connection**

- Useful Information about Network Connection

▶ **About Network Communication**

- Changing and Confirming Network Settings
- Appendix for Network Communication

▶ **Tips for Ensuring Optimal Printing Quality**

- Useful Information about Ink
- Key Points to Successful Printing
- Be Sure to Make Paper Settings after Loading Paper
- Canceling a Print Job
- Printer Handling Precautions
- Key to Enjoying Consistent Printing Quality
- Precautions for Safe Transport of the Printer

▶ **Legal Limitations on Use of Your Product and Use of Images**

▶ **Specifications**

Safety Guide

- ▶ **Safety Precautions**
- ▶ **Regulatory and Safety Information**

Safety Precautions

Choosing a location

- Do not install the machine in a location that is unstable or subject to excessive vibration.
- Do not install the machine in locations that are very humid or dusty, in direct sunlight, outdoors, or close to a heating source.
To avoid the risk of fire or electric shocks, use the machine under the operating environment specified in the On-screen Manual.
- Do not place the machine on a thick rug or carpet.
- Do not place the machine with its back attached to the wall.

Power supply

- Ensure that the area around the power outlet is kept clear at all times so you can easily unplug the power cord if necessary.
- Never remove the plug by pulling on the cord.
Pulling the cord may damage the power cord, leading to possible fire or electrical shock.
- Do not use an extension lead/cord.

Working around the machine

- Never put your hands or fingers in the machine while it is printing.
- When moving the machine, carry the machine at both ends. In case the machine weighs more than 14 kg, it is recommended to have two people lifting the machine. Accidental dropping of the machine causes injury. For the machine's weight, refer to the On-screen Manual.
- Do not place any object on the machine. Especially do not place metal objects (paper clips, staples, etc.) or containers of flammable solvents (alcohol, thinners, etc.) on top of the machine.
- Do not transport or use the machine on a slant, vertically or upside-down, as the ink may leak and damage the machine.

Working around the machine (For the multifunction printer)

- When loading a thick book on the Platen Glass, do not press hard on the Document Cover. The Platen Glass may break and cause injury.

Print Heads/ink tanks and FINE Cartridges

- Keep ink tanks out of the reach of children. In case ink* is accidentally licked or swallowed, rinse out mouth or give one or two glasses of water to drink. If irritation or discomfort occurs, obtain medical advice immediately.
* Clear Ink contains nitrate salts (For models containing Clear Ink).
- In case ink gets in contact with eyes, rinse with water immediately. In case ink gets in contact with skin, wash with soap and water immediately. If irritation to eyes or skin persists, obtain medical advice immediately.
- Never touch the electrical contacts on a Print Head or FINE Cartridges after printing.
The metal parts may be very hot and could cause burns.
- Do not throw ink tanks and FINE Cartridges into fire.
- Do not attempt to disassemble or modify the Print Head, ink tanks, and FINE Cartridges.

Regulatory and Safety Information

For models containing lithium battery

- Dispose of used batteries according to the local regulations.
- Risk of explosion if battery is replaced by an incorrect type.

Users in the U.S.A.

FCC Notice (U.S.A. Only)

For 120V, 60Hz model

Model Number: K10418 (Contains FCC Approved WLAN Module K30357)

This device complies with Part 15 of the FCC Rules. Operation is subject to the following two conditions: (1) This device may not cause harmful interference, and (2) this device must accept any interference received, including interference that may cause undesired operation.

Note: This equipment has been tested and found to comply with the limits for a Class B digital device, pursuant to Part 15 of the FCC Rules. These limits are designed to provide reasonable protection against harmful interference in a residential installation. This equipment generates, uses and can radiate radio frequency energy and, if not installed and used in accordance with the instructions, may cause harmful interference to radio communications.

However, there is no guarantee that interference will not occur in a particular installation. If this equipment does cause harmful interference to radio or television reception, which can be determined by turning the equipment off and on, the user is encouraged to try to correct the interference by one or more of the following measures:

- Reorient or relocate the receiving antenna.
- Increase the separation between the equipment and receiver.
- Connect the equipment into an outlet on a circuit different from that to which the receiver is connected.
- Consult the dealer or an experienced radio/TV technician for help.

Use of a shielded cable is required to comply with Class B limits in Subpart B of Part 15 of the FCC Rules.

Do not make any changes or modifications to the equipment unless otherwise specified in the manual. If such changes or modifications should be made, you could be required to stop operation of the equipment.

FCC ID:AZDK30357

Changes or modifications not expressly approved by the party responsible for compliance could void the user's authority to operate equipment.

This transmitter must not be co-located or operating in conjunction with any other antenna or transmitter.

The equipment complies with FCC radiation exposure limits for uncontrolled equipment. This equipment should be installed and operated with minimum distance at least 20cm between the radiator and persons body (excluding extremities: hands, wrists, feet and ankles) and must not be colocated or operated with any other antenna or transmitter.

Canon U.S.A., Inc.

One Canon Park

Melville, New York 11747

1-800-652-2666

Users in Canada

This device complies with Industry Canada license-exempt RSS standard(s). Operation is subject to the following two conditions:

(1) this device may not cause interference, and (2) this device must accept any interference, including interference that may cause undesired operation of the device.

This equipment complies with IC radiation exposure limits set forth for an uncontrolled environment and meets RSS-102 of the IC radio frequency (RF) Exposure rules. This equipment should be installed and operated keeping the radiator at least 20cm or more away from person's body (excluding extremities: hands, wrists, feet and ankles).

Pour les usagers résidant au Canada

Le présent appareil est conforme aux CNR d'Industrie Canada applicables aux appareils radio exempts de licence. L'exploitation est autorisée aux deux conditions suivantes :

(1) l'appareil ne doit pas produire de brouillage, et (2) l'utilisateur de l'appareil doit accepter tout brouillage radioélectrique subi, même si le brouillage est susceptible d'en compromettre le fonctionnement.

Cet équipement est conforme aux limites d'exposition aux rayonnements énoncées pour un environnement non contrôlé et respecte les règles d'exposition aux fréquences radioélectriques (RF) CNR-102 de l'IC. Cet équipement doit être installé et utilisé en gardant une distance de 20 cm ou plus entre le dispositif rayonnant et le corps (à l'exception des extrémités : mains, poignets, pieds et chevilles).

Users in Jordan

This printer contains WLAN Module approved by TRC/LPD/2013/130

Name of WLAN Module : K30357

Only for European Union and EEA (Norway, Iceland and Liechtenstein)



These symbols indicate that this product is not to be disposed of with your household waste, according to the WEEE Directive (2012/19/EU), the Battery Directive (2006/66/EC) and/or national legislation implementing those Directives. If a chemical symbol is printed beneath the symbol shown above, in accordance with the Battery Directive, this indicates that a heavy metal (Hg = Mercury, Cd = Cadmium, Pb = Lead) is present in this battery or accumulator at a concentration above an applicable threshold specified in the Battery Directive. This product should be handed over to a designated collection point, e.g., on an authorized one-for-one basis when you buy a new similar product or to an authorized collection site for recycling waste electrical and electronic equipment (EEE) and batteries and accumulators. Improper handling of this type of waste could have a possible impact on the environment and human health due to potentially hazardous substances that are generally associated with EEE. Your cooperation in the correct disposal of this product will contribute to the effective usage of natural resources. For more information about the recycling of this product, please contact your local city office, waste authority, approved scheme or your household waste disposal service or visit www.canon-europe.com/weee, or www.canon-europe.com/battery.

Korisnici u Srbiji



Ovaj simbol označava da ovaj proizvod ne sme da se odlaže sa ostalim kućnim otpadom, u skladu sa WEEE Direktivom (2012/19/EU), Direktivom o baterijama (2006/66/EC) i nacionalnim zakonima. Ukoliko je ispod gore navedenog simbola odštampan hemijski simbol, u skladu sa Direktivom o baterijama, ovaj simbol označava da su u ovoj bateriji ili akumulatoru prisutni teški metali (Hg – živa, Cd – kadmijum, Pb - olovo) u koncentracijama koje premašuju prihvatljivi prag naveden u Direktivi o baterijama. Ovaj proizvod treba predati određenom centru za prikupljanje, npr. po principu „jedan-za-jedan“ kada kupujete sličan novi proizvod, ili ovlašćenom centru za prikupljanje za reciklažu istrošene električne i elektronske opreme (EEE), baterija i akumulatora. Nepravilno rukovanje ovom vrstom otpada može imati negativne posledice po životnu sredinu i ljudsko zdravlje usled potencijalno opasnih materijala koji se uglavnom vezuju za EEE. Vaša saradnja na ispravnom odlaganju ovog proizvoda će doprineti efikasnom korišćenju prirodnih resursa. Više informacija o tome kako možete da recikirate ovaj proizvod potražite od lokalnih gradskih vlasti, komunalne službe, odobrenog plana reciklaže ili servisa za odlaganje kućnog otpada, ili posetite stranicu www.canon-europe.com/weee, ili www.canon-europe.com/battery.

Environmental Information

Reducing your environmental impact while saving money

Power Consumption and Activation Time

The amount of electricity a device consumes depends on the way the device is used. This product is designed and set in a way to allow you to reduce your electricity costs. After the last print it switches to Ready Mode. In this mode it can print again immediately if required. If the product is not used for a time, the device switches to its Power Save Mode. The devices consume less power (Watt) in these modes. If you wish to set a longer Activation Time or would like to completely deactivate the Power Save Mode, please consider that this device may then only switch to a lower energy level after a longer period of time or not at all.

Canon does not recommend extending the Activation Times from the optimum ones set as default.

Energy Star®

The Energy Star® programme is a voluntary scheme to promote the development and purchase of energy efficient models, which help to minimise environmental impact.

Products which meet the stringent requirements of the Energy Star® programme for both environmental benefits and the amount of energy consumption will carry the Energy Star® logo accordingly.

Paper types

This product can be used to print on both recycled and virgin paper (certified to an environmental stewardship scheme), which complies with EN12281 or a similar quality standard. In addition it can support printing on media down to a weight of 64g/m², lighter paper means less resources used and a lower environmental footprint for your printing needs.

RMC

Regulatory Model Code (RMC) is for identification and proof that the product complies with the regulations. Please note that RMC is different from the marketing model number of the product.



Main Components and Basic Operations

- ▶ **Main Components**
- ▶ **About the Power Supply of the Printer**

Main Components

- ▶ **Front View**
- ▶ **Rear View**
- ▶ **Inside View**

Front View

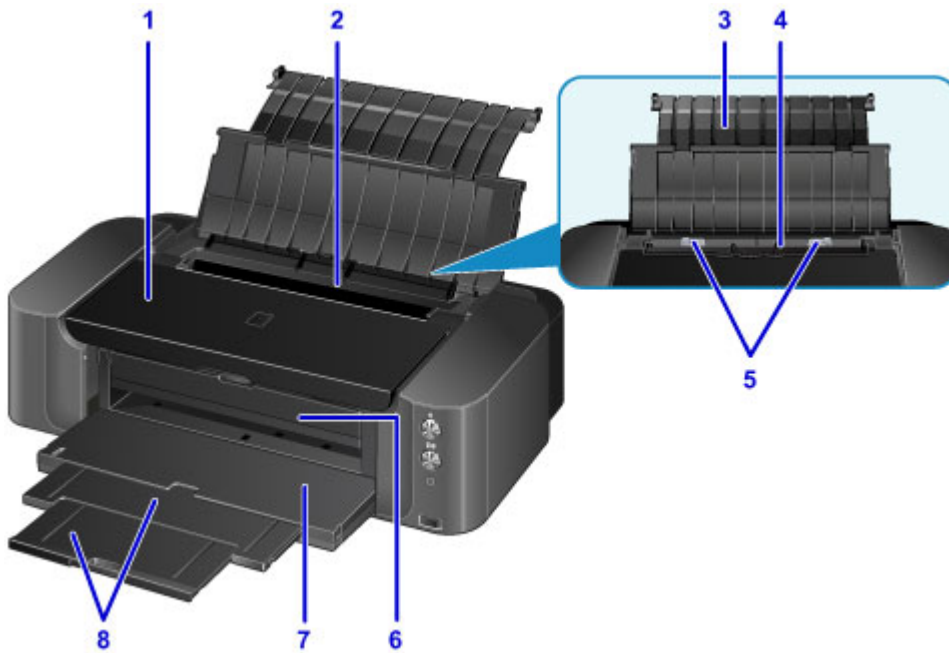

(1) top cover

Open to replace an ink tank or remove jammed paper inside the printer.

(2) feed slot cover

Prevents anything from falling into the feed slot.

Open it to slide the paper guides, and close it before printing.

(3) paper support

Open to load paper in the rear tray.

(4) rear tray

Two or more sheets of the same size and type of paper can be loaded at the same time, and fed automatically one sheet at a time.

■ [Loading Paper in the Rear Tray](#)

(5) paper guides

Align with both sides of the paper stack.

(6) disc tray guide

Attach the disc tray here. Use when printing onto a printable disc. Keep closed for normal operation.

(7) paper output tray

Printed paper is ejected. Open it before printing.

(8) output tray extension

Pull out to support ejected paper.



* All buttons and lamps are shown lit in the above figure for explanatory purposes.

(9) POWER lamp

Lights after flashing when the power is turned on.

▶▶▶ Note

- You can check the status of the printer by the **POWER** and **Alarm** lamps.
 - **POWER** lamp is off: The power is off.
 - **POWER** lamp lights: The printer is ready to print.
 - **POWER** lamp flashes: The printer is getting ready to print, or printing is in progress.
 - **Alarm** lamp flashes: An error has occurred and the printer is not ready to print.
 - **POWER** lamp flashes and **Alarm** lamp flashes alternately: An error that requires contacting the service center may have occurred.

■ [If an Error Occurs](#)

(10) ON button

Turns the power on or off.

■ [Turning the Printer On and Off](#)

(11) Alarm lamp

Lights or flashes when an error occurs.

(12) RESUME/CANCEL button

Cancels a print job in progress. You can press this button to release from printer error status and resume printing, after the printer problem is resolved.

(13) Wi-Fi button/Wi-Fi lamp

Hold down to automatically set up the wireless LAN connection.

Lights or flashes to indicate the wireless LAN status.

Lights:

Wireless LAN connection is enabled.

Flashes:

Printing over wireless LAN. Also flashes while configuring the wireless LAN connection.

(14) direct print port

Connect a PictBridge compliant device such as a digital camera to print directly.

⚠ Warning

- Do not connect any equipment other than PictBridge compliant devices to the direct print port of the printer. This may cause fire, electric shock, or damage to the printer.

»» Important

- Do not touch the metal casing.
- Do not use the USB cable longer than 10 feet (3 meters) to connect any PictBridge compliant device to the printer since it may affect the operation of other peripheral devices.

(15) disc tray storage compartment

The disc tray supplied with the printer can be stored here.

- [Storing the disc tray](#)

Rear View

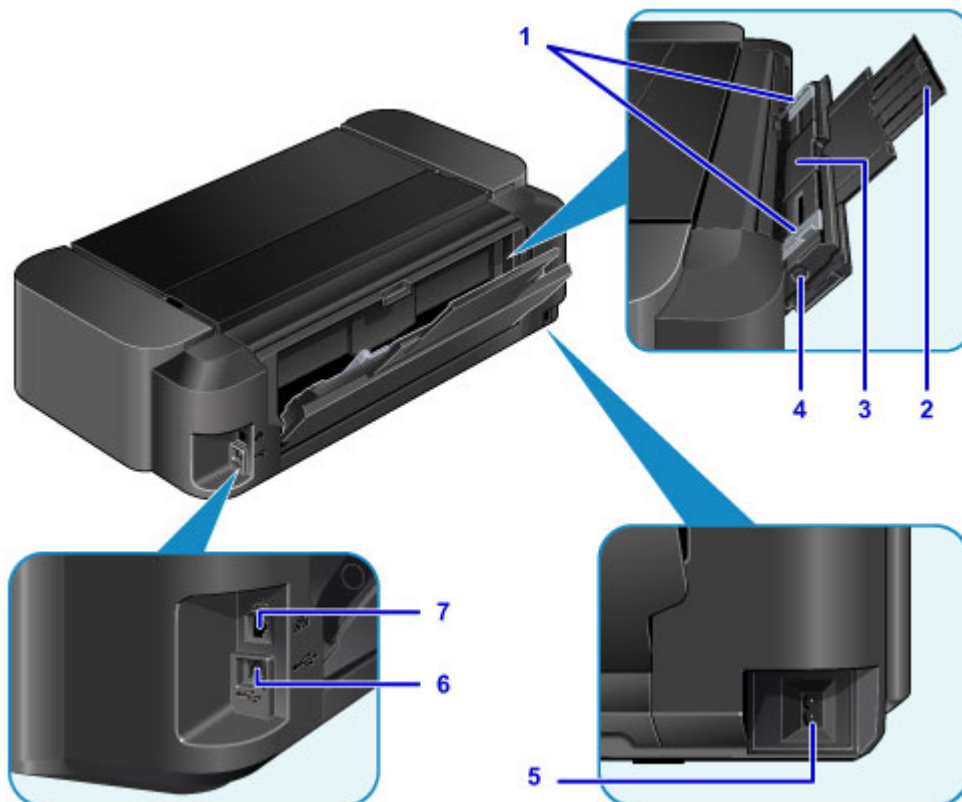

(1) paper guides

Align with both sides of the paper stack.

(2) paper support

Open and pull out to load paper in the manual feed tray.

(3) manual feed tray

Load a sheet of large size paper, such as 14" x 17" (36 x 43 cm) paper, or thick paper.

■ [Loading Paper in the Manual Feed Tray](#)

■ [Media Types You Can Use](#)

(4) Paper Jam Clearing button

Press this button when removing paper jammed in the manual feed tray.

■ [Paper Jams](#)

(5) power cord connector

Plug in the supplied power cord.

(6) USB port

Plug in the USB cable to connect the printer with a computer.

(7) wired LAN connector

Plug in the LAN cable to connect the printer to a LAN.

▶▶▶ Important

- Do not touch the metal casing.
- Do not plug in or unplug the USB cable or LAN cable while printing.

Inside View

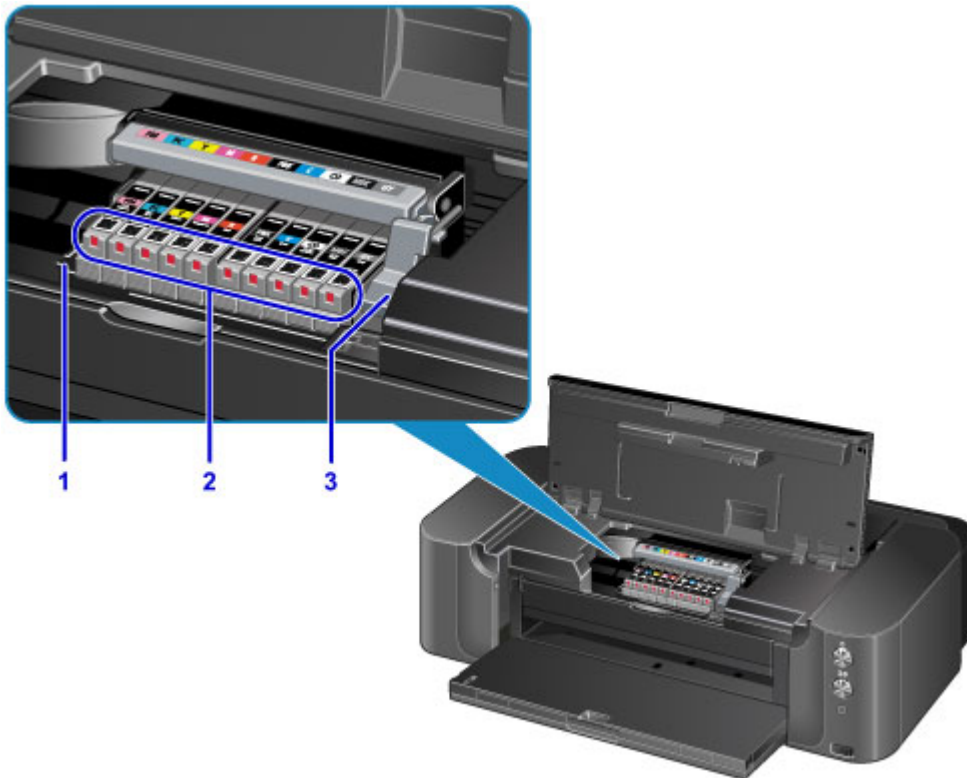

(1) print head holder

Install the print head here.

(2) ink lamps

Lights or flashes to indicate the ink tank status.

■ [Checking the Ink Status with the Ink Lamps](#)

(3) print head lock lever

Locks the print head into place.

►► Important

- Do not raise this lever after installing the print head.

►► Note

- For details on replacing an ink tank, see [Replacing an Ink Tank](#).

About the Power Supply of the Printer

- **Confirming that the Power Is On**
- **Turning the Printer On and Off**
- **Notice for the Power Plug/Power Cord**
- **Notice for Unplugging the Power Cord**

Confirming that the Power Is On

The **POWER** lamp is lit when the printer is turned on.



▶▶ Note

- It may take a while for the printer to start printing immediately after you turn on the printer.

Turning the Printer On and Off

Turning on the printer

1. Press the **ON** button to turn on the printer.

The **POWER** lamp flashes and then remains lit.

■ [Confirming that the Power Is On](#)



►► Note

- It may take a while for the printer to start printing immediately after you turn on the printer.
- When the power is turned on, the printer may start mixing the ink to maintain optimal ink quality (about 30 seconds to 3 minutes).

■ [Ink is mixed at fixed intervals.](#)

- If the **Alarm** lamp flashes, see [If an Error Occurs](#).
- You can set the printer to automatically turn on when a print operation is performed from a computer connected by USB cable or network. This feature is set to off by default.

■ [Managing the Printer Power](#)

Turning off the printer

1. Press the **ON** button to turn off the printer.

When the **POWER** lamp stops flashing, the printer is turned off.



»» Important

- When you [unplug the power cord](#) after turning off the printer, be sure to confirm that the **POWER** lamp is off.

»» Note

- You can set the printer to automatically turn off when no print jobs are sent to the printer for a certain interval. This is the default setting.

■ [Managing the Printer Power](#)

Notice for the Power Plug/Power Cord

Unplug the power cord once a month to confirm that the power plug/power cord does not have anything unusual described below.

- The power plug/power cord is hot.
- The power plug/power cord is rusty.
- The power plug/power cord is bent.
- The power plug/power cord is worn.
- The power plug/power cord is split.

Caution

- If you find anything unusual with the power plug/power cord described above, [unplug the power cord](#) and call for service. Using the printer with one of the unusual conditions above may cause a fire or an electric shock.

Notice for Unplugging the Power Cord

To unplug the power cord, follow the procedure below.

►► Important

- When you unplug the power cord, press the **ON** button, then confirm that the **POWER** lamp is off. Unplugging the power cord while the **POWER** lamp is lit or flashing may cause drying or clogging of the print head and print quality may be reduced.

1. Press the **ON** button to turn the printer off.



2. Confirm that the **POWER** lamp is off.

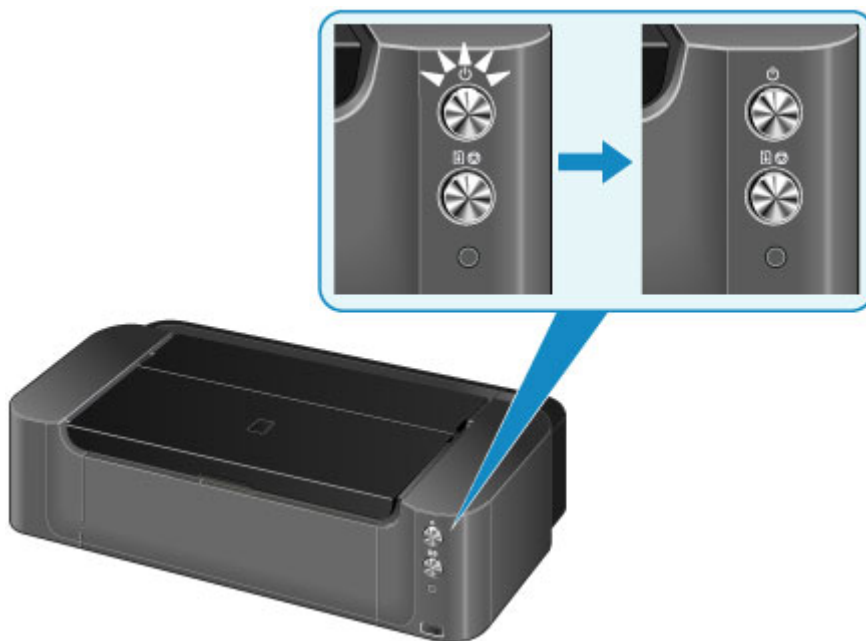

3. Unplug the power cord.

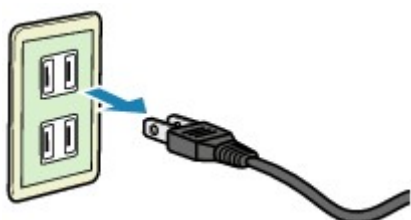

The specification of the power cord differs depending on the country or region of use.

Loading Paper

- ▶ **Loading Paper**
- ▶ **Placing a Printable Disc**

Loading Paper

- ▶ **Paper Sources to Load Paper**
- ▶ **Loading Paper in the Rear Tray**
- ▶ **Loading Paper in the Manual Feed Tray**
- ▶ **Media Types You Can Use**
- ▶ **Media Types You Cannot Use**
- ▶ **Handling Paper**
- ▶ **Before Printing on Art Paper**
- ▶ **Printing Area**

Paper Sources to Load Paper

The printer has two paper sources for feeding paper, the rear tray and manual feed tray.

The paper source used depends on the page size and media type.

■ [Media Types You Can Use](#)

▶▶▶ Note

- When printing, select the correct page size, media type, and paper source. If you select the wrong page size or media type, the printer may not print with the proper print quality.

For details on how to load paper in each paper source, see below.

■ [Loading Paper in the Rear Tray](#)

■ [Loading Paper in the Manual Feed Tray](#)

Loading Two or More Sheets of Paper in the rear tray

When printing on paper from the sizes 4" x 6" (10 x 15 cm) to 10" x 12" (25 x 30 cm) or A3+, load them in the rear tray. Two or more sheets of the same size and media type can be loaded at a time, allowing you to print continuously. (Some page sizes or media types can be loaded only one sheet at a time.)

Select a page size, media type, paper source, etc. in the printer driver setting when printing.



Loading One Sheet of Large Size Paper or Thick Paper in the manual feed tray

When printing on large size paper such as 14" x 17" (36 x 43 cm) paper, or thick paper such as art paper, load it in the manual feed tray.

Select a page size, media type, paper source, etc. in the printer driver setting when printing.

The manual feed tray does not accept plain paper. When printing on plain paper, load it in the rear tray.



Loading Paper in the Rear Tray

You can load A3+, A3, B4, A4, B5, A5, Letter, Legal, 11" x 17" (279.4 x 431.8 mm), 4" x 6" (10 x 15 cm), 5" x 7" (13 x 18 cm), 8" x 10" (20 x 25 cm), and 10" x 12" (25 x 30 cm) sizes of paper in the rear tray.

▶▶▶ Important

- If you cut plain paper into small size such as 4" x 6" (10 x 15 cm) or 5" x 7" (13 x 18 cm) to perform trial print, it can cause paper jams.

▶▶▶ Note

- We recommend Canon genuine photo paper for printing photos.
For details on the Canon genuine paper, see [Media Types You Can Use](#).
- You can use general copy paper.
For the page size and paper weight you can use for this printer, see [Media Types You Can Use](#).

1. Prepare paper.

Align the edges of paper. If paper is curled, flatten it.

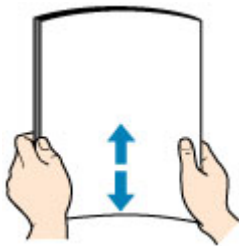

▶▶▶ Note

- Align the edges of paper neatly before loading. Loading paper without aligning the edges may cause paper jams.
- If paper is curled, hold the curled corners and gently bend them in the opposite direction until the paper becomes completely flat.
For details on how to flatten curled paper, see "Load the paper after correcting its curl." in [Paper Is Smudged/Printed Surface Is Scratched](#).
- When using Photo Paper Plus Semi-gloss SG-201, even if the sheet is curled, load one sheet at a time as it is. If you roll up this paper to flatten, this may cause cracks on the surface of the paper and reduce the print quality.

2. Open the paper support (A) of the rear tray.

3. Open the paper output tray (B) gently.

▶▶▶ Important

- If the disc tray guide (C) is open, be sure to close it.

4. Pull out the output tray extension (D).

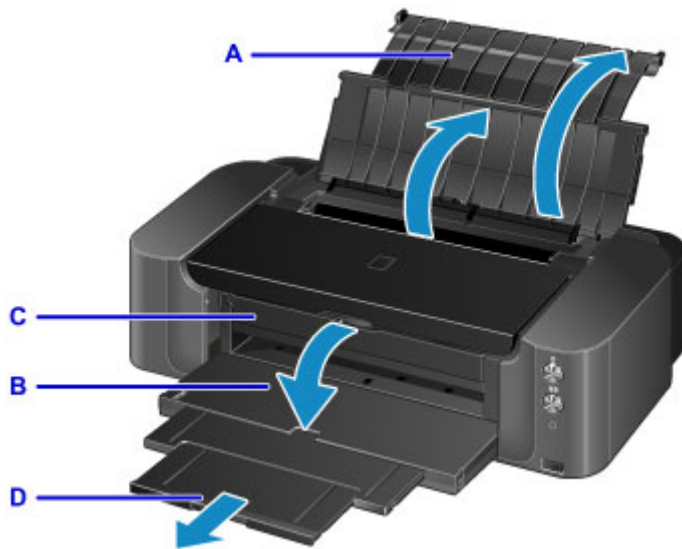

5. Open the feed slot cover.

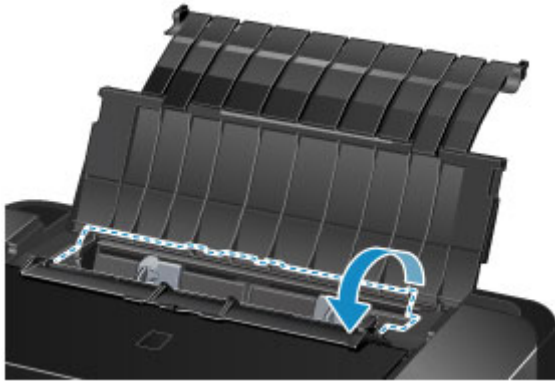

6. Slide the paper guides (E) to open them, and load the paper in the center of the rear tray WITH THE PRINT SIDE FACING YOU.

7. Slide the paper guides (E) to align them with both sides of the paper stack.

Do not slide the paper guides too hard against the paper. The paper may not be fed properly.

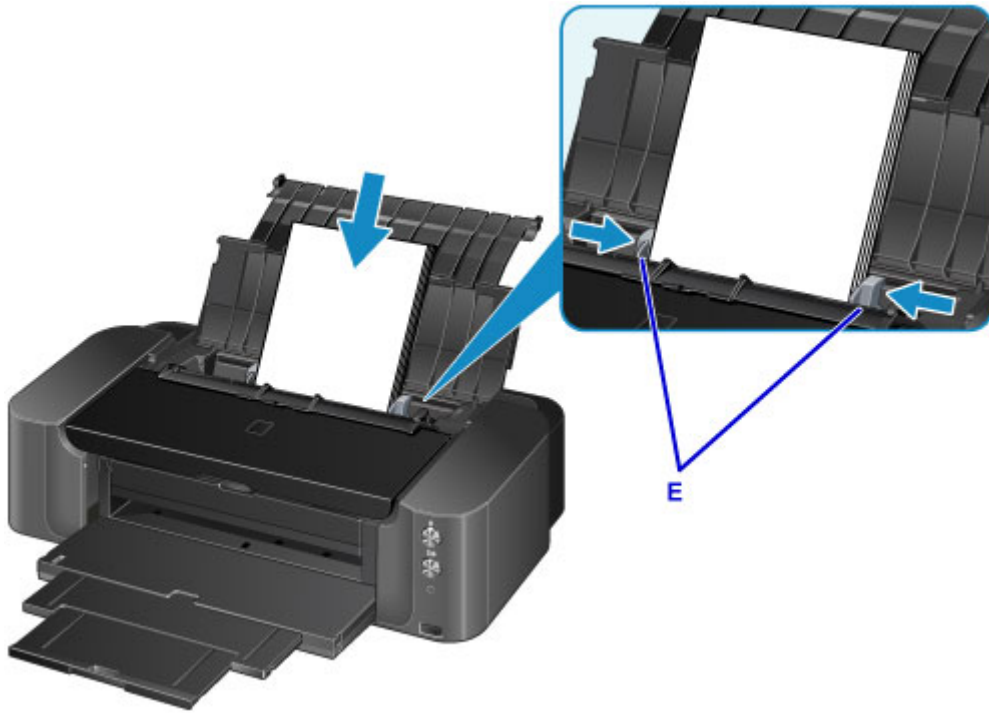

►► Important

- Always load paper in the portrait orientation (F). Loading paper in the landscape orientation (G) can cause paper jams.

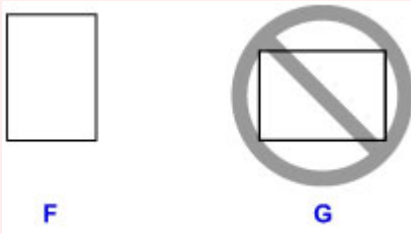

►► Note

- Do not load sheets of paper higher than the load limit mark (H).
- The raised parts (I) on the paper guides retract depending on the size of the loaded paper. Do not push these parts down with your finger.

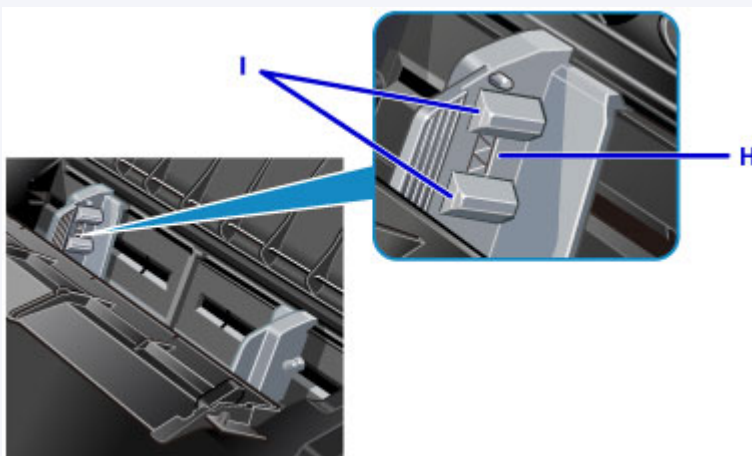

8. Close the feed slot cover gently.

»» Important

- If the feed slot cover is open, paper cannot be fed. Be sure to close the feed slot cover.



»» Note

- When printing, select the rear tray for the paper source and the size and type of the loaded paper on the print settings screen of the printer driver.

Loading Paper in the Manual Feed Tray

You can load A3+, A3, B4, A4, Letter, Legal, 11" x 17" (279.4 x 431.8 mm), 8" x 10" (20 x 25 cm), 10" x 12" (25 x 30 cm), and 14" x 17" (36 x 43 cm) sizes of paper in the manual feed tray.

▶▶▶ Note

- We recommend Canon genuine photo paper for printing photos.
For details on the Canon genuine paper, see [Media Types You Can Use](#).
- The manual feed tray does not accept plain paper. When printing on plain paper, load it in the rear tray.
- When printing on paper other than 14" x 17" (36 x 43 cm) size from a PictBridge compliant device, load paper in the rear tray.

■ [Printing from a Digital Camera](#)

1. Prepare paper.

If paper is curled, flatten it.

▶▶▶ Note

- If paper is curled, hold the curled corners and gently bend them in the opposite direction until the paper becomes completely flat.
For details on how to flatten curled paper, see "Load the paper after correcting its curl." in [Paper Is Smudged/Printed Surface Is Scratched](#).
- When using Photo Paper Plus Semi-gloss SG-201, even if the sheet is curled, load one sheet at a time as it is. If you roll up this paper to flatten, this may cause cracks on the surface of the paper and reduce the print quality.

2. Open the paper support (A) of the manual feed tray, and pull it out.

3. Open the paper output tray (B) gently.

▶▶▶ Important

- If the disc tray guide (C) is open, be sure to close it.

4. Pull out the output tray extension (D).

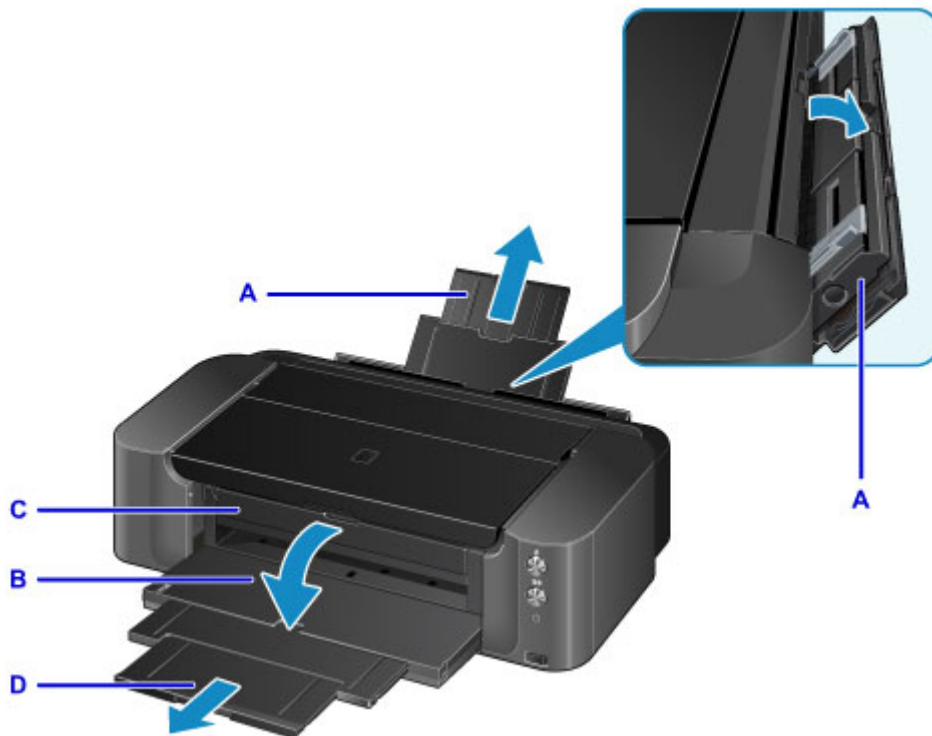

5. Slide the paper guides (E) to open them, and load ONLY ONE SHEET OF PAPER in the center of the manual feed tray WITH THE PRINT SIDE FACING YOU.

6. Slide the paper guides (E) to align them with both sides of the paper stack.

Do not slide the paper guides too hard against the paper. The paper may not be fed properly.

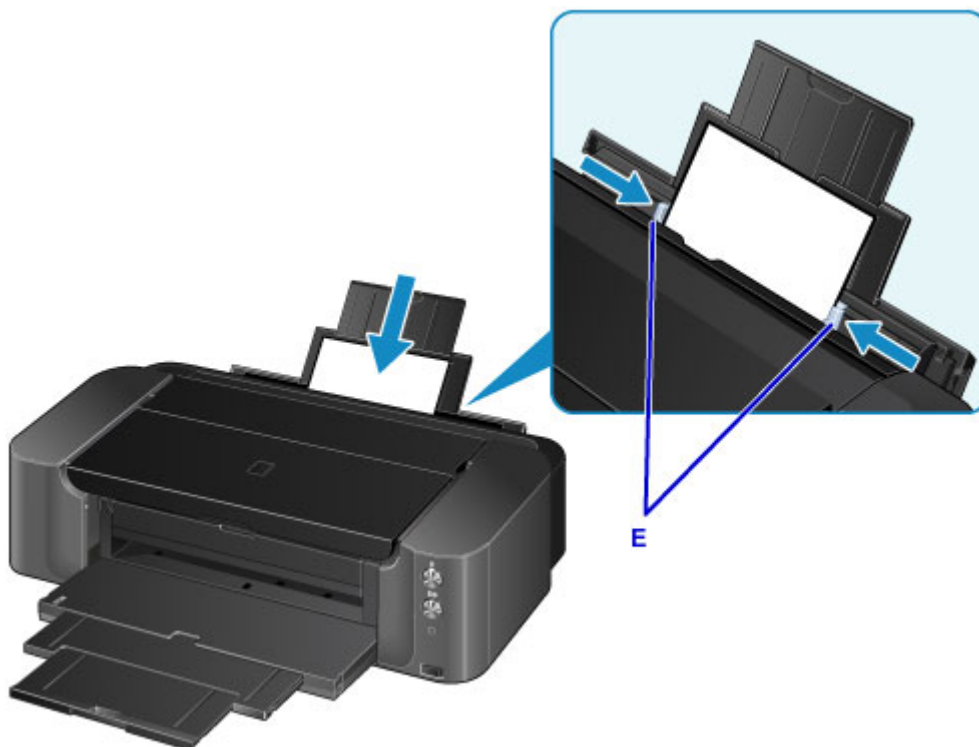

»»» Important

- Always load paper in the portrait orientation (F). Loading paper in the landscape orientation (G) can cause paper jams.

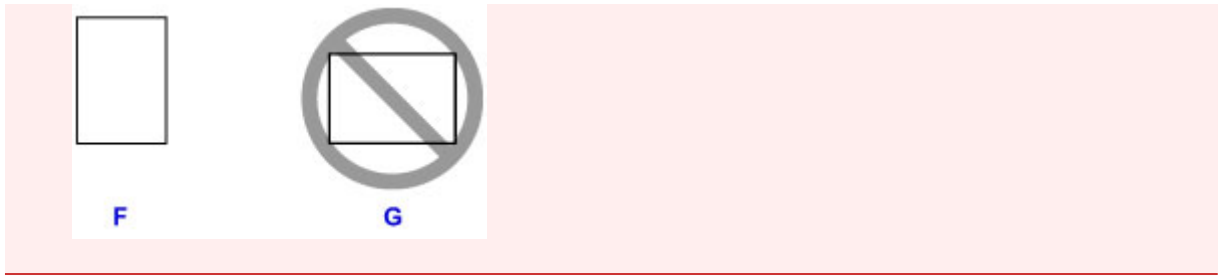

7. Check if the paper is set properly in the manual feed tray.

Make sure that the paper is set firmly against the bottom of the manual feed tray and against the paper guides by slightly jiggling the paper up and down.



»» Note

- When printing, select the manual feed tray for the paper source and the size and type of the loaded paper on the print settings screen of the printer driver.
- To continue printing from the manual feed tray, wait until printing is complete, then load the next sheet.

Media Types You Can Use

To get the best printing result, choose paper suitable for printing. Canon provides various types of paper suitable for documents as well as paper suitable for photos or illustrations. We recommend the use of Canon genuine paper for printing your important photos.

Media Types

Commercially available papers

- Plain Paper (including recycled paper)

Canon genuine papers

The Model Number of Canon genuine paper is shown in brackets. Refer to the instruction manual supplied with the paper for detailed information on the printable side and notes on handling paper. For information on the page sizes available for each Canon genuine paper, access our website.

▶▶▶ Note

- You may not be able to purchase some Canon genuine papers depending on the country or region of purchase. Paper is not sold in the US by Model Number. Purchase paper by name.

Paper for printing photos:

- Photo Paper Pro Platinum <PT-101>
- Photo Paper Plus Glossy II <PP-201>
- Photo Paper Pro Luster <LU-101>
- Photo Paper Plus Semi-gloss <SG-201>
- Matte Photo Paper <MP-101>^{*1}
- Fine Art Paper "Museum Etching" <FA-ME1>^{*1*2}
- Photo Paper Pro Premium Matte <PM-101>^{*1*2}

*1 Printing to this paper from a digital camera is not supported.

*2 You cannot print in the top and bottom 1.18 inch (30 mm) margins of the paper (in the printing direction). For details on the printing area, see [Sizes for Art Paper](#).

When using art paper, see [Before Printing on Art Paper](#).

■ [Paper Load Limit](#)

■ [Paper Settings on the Printer Driver](#)

▶▶▶ Note

- You can print onto a printable disc using the disc tray supplied with the printer.
 - [Placing a Printable Disc](#)
- When printing photos saved on a PictBridge compliant device, you must specify the page size and media type.
 - [Printing from a Digital Camera](#)
- You can use non-Canon genuine art paper. For details, access our website.

You cannot print in the top and bottom 1.18 inch (30 mm) margins of the paper (in the printing direction).

■ [Sizes for Art Paper](#)

■ [Before Printing on Art Paper](#)

Page Sizes

You can use the following page sizes.

►► Note

- You can load the page sizes as follows.
 - rear tray: A3+, A3, B4, A4, B5, A5, Letter, Legal, 11" x 17" (279.4 x 431.8 mm), 4" x 6" (10 x 15 cm), 5" x 7" (13 x 18 cm), 8" x 10" (20 x 25 cm), and 10" x 12" (25 x 30 cm)
 - manual feed tray: A3+, A3, B4, A4, Letter, Legal, 11" x 17" (279.4 x 431.8 mm), 8" x 10" (20 x 25 cm), 10" x 12" (25 x 30 cm), and 14" x 17" (36 x 43 cm)
- Printing on the following page sizes from a digital camera is not supported.
 - B4, B5, A5, Legal, 11" x 17" (279.4 x 431.8 mm), 10" x 12" (25 x 30 cm), and 14" x 17" (36 x 43 cm)

Standard sizes:

- Letter
- Legal
- 11" x 17" (279.4 x 431.8 mm)
- A5
- A4
- A3
- A3+
- B5
- B4
- 4" x 6" (10 x 15 cm)
- 5" x 7" (13 x 18 cm)
- 8" x 10" (20 x 25 cm)
- 10" x 12" (25 x 30 cm)
- 14" x 17" (36 x 43 cm)

Non-standard sizes:

You can print on non-standard size paper within the following ranges.

- rear tray
 - Minimum size: 3.50 x 5.00 inches (89.0 x 127.0 mm)
 - Maximum size: 12.95 x 26.61 inches (329.0 x 676.0 mm)
- manual feed tray
 - Minimum size: 8.00 x 10.00 inches (203.2 x 254.0 mm)
 - Maximum size: 14.00 x 23.00 inches (355.6 x 584.2 mm)

Paper Weight / Thickness

You can use paper in the following weight/thickness ranges.

- rear tray: From 17 to 28 lb (64 to 105 g /m²) (plain paper except for Canon genuine paper)

* You can use non-Canon genuine specialty paper that is up to 53 lb (200 g /m²).

Do not use heavier or lighter paper (except for Canon genuine paper), as it could jam in the printer.

- manual feed tray: From 4 to 23.6 mil (0.1 to 0.6 mm) (up to 93 lb (350 g /m²))

Do not use paper thicker or heavier than this, as it could jam in the printer.

Paper Load Limit

Commercially Available Papers

Media Name	Rear Tray	Manual Feed Tray	Paper Output Tray
Plain Paper (including recycled paper)* 1	Approx. 150 sheets (14" x 17" (36 x 43 cm) is not available.)	N/A* 2	Approx. 50 sheets

Canon Genuine Papers

►► Note

- We recommend that you remove the previously printed sheet from the paper output tray before continuously printing to avoid blurs and discoloration.

Paper for printing photos:

Media Name <Model No.>	Rear Tray	Manual Feed Tray
Photo Paper Pro Platinum <PT-101>* 3	1 sheet: A3+ 10 sheets: A3, A4, Letter, and 8" x 10" (20 x 25 cm) 20 sheets: 4" x 6" (10 x 15 cm)	1 sheet: A3+, A3, A4, Letter, and 8" x 10" (20 x 25 cm)
Photo Paper Plus Glossy II <PP-201>* 3	1 sheet: A3+ 10 sheets: A3, A4, Letter, 5" x 7" (13 x 18 cm), and 8" x 10" (20 x 25 cm) 20 sheets: 4" x 6" (10 x 15 cm)	1 sheet: A3+, A3, A4, Letter, and 8" x 10" (20 x 25 cm)
Photo Paper Pro Luster <LU-101>* 3	1 sheet: A3+ 10 sheets: A3, A4, and Letter	1 sheet: A3+, A3, A4, and Letter
Photo Paper Plus Semi-gloss <SG-201>* 3	1 sheet: A3+ 10 sheets: A3, A4, Letter, 5" x 7" (13 x 18 cm), and 8" x 10" (20 x 25 cm) 20 sheets: 4" x 6" (10 x 15 cm)	1 sheet: A3+, A3, A4, Letter, and 8" x 10" (20 x 25 cm)
Matte Photo Paper <MP-101>	1 sheet: A3+ 10 sheets: A3, A4, and Letter 20 sheets: 4" x 6" (10 x 15 cm)	1 sheet: A3+, A3, A4, and Letter
Fine Art Paper "Museum Etching" <FA-ME1>	N/A* 4	1 sheet
Photo Paper Pro Premium Matte <PM-101>	N/A* 4	1 sheet

*1 Proper feeding of paper may not be possible at the maximum capacity depending on the type of paper or environmental conditions (either very high or low temperature or humidity). In such cases, reduce the number of paper you load at a time to less than half.

*2 Feeding paper from the manual feed tray can damage the printer. Always load in the rear tray.

*3 When loading paper in stacks, the print side may become marked as it is fed or paper may not feed properly. In this case, load one sheet at a time.

*4 Feeding paper from the rear tray can damage the printer. Always load in the manual feed tray.

▶▶ Note

- When using non-Canon art paper, load one sheet at a time in the rear tray or manual feed tray.

Media Types You Cannot Use

Do not use the following types of paper. Using such paper will cause not only unsatisfactory results, but also the printer to jam or malfunction.

- Folded, curled, or wrinkled paper
- Damp paper
- Paper that is too thin

rear tray: Less than 17 lb (64 g /m²)

manual feed tray: Less than 4 mil (0.1 mm)

- Paper that is too thick

rear tray: More than 28 lb (105 g /m²) (plain paper except for Canon genuine paper)

manual feed tray: More than 23.6 mil (0.6 mm) in thickness or more than 93 lb (350 g /m²) in weight

- Paper thinner than a postcard, including plain paper or notepad paper cut to a small size (when printing on paper smaller than A5)
- Picture postcards
- Postcards affixed with photos or stickers
- Envelopes
- Any type of paper with holes
- Paper that is not rectangular
- Paper bound with staples or glue
- Paper with adhesives
- Paper decorated with glitter, etc.
- Do not use the following types of Canon genuine paper.
 - Glossy Photo Paper "Everyday Use" <GP-501/GP-601>
 - Photo Paper Glossy <GP-601>
 - High Resolution Paper <HR-101N>

Handling Paper

- Be careful not to rub or scratch the surfaces of any types of paper when handling.
- Hold the paper as closely as possible to its edges and try not to touch the printing surface. The print quality may be degraded if the printing surface is smudged with sweat or oil that comes from your hands.
- Do not touch the printed surface until the ink is dried. Even when the ink is dried, be careful not to touch the printed surface as much as possible when handling. Due to the nature of the pigment ink, the ink on the printed surface may be removed when being rubbed or scratched.
- Take out only the necessary number of paper from the package, just before printing.
- To avoid curling, when you do not print, put unused paper back into the package and keep it on a level surface. And also, store it avoiding heat, humidity, and direct sunlight.

Before Printing on Art Paper

When using art paper, dust is liable to be generated. It is therefore recommended that paper dust be removed on art paper just before printing.

You will need a soft hair brush (or similar brush used to clean office automation equipment).

The wider the brush, the more effective it will be.



OK - soft brush made from material such as polypropylene, polyethylene, horse hair or goat hair.

►► Important

- Be sure not to use brushes as shown below. The printing surface may be damaged.



Not OK - brush made from hard material, cloth or washcloth, sticky and abrasive materials.

Paper dust removal procedure:

1. Check that the brush is not wet and free from dust or dirt.
2. Brush the overall printing surface carefully in one direction.

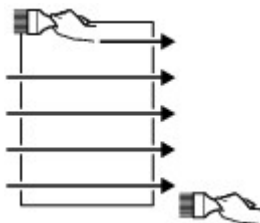

►► Important

- Be sure to brush all the way across the paper; do not start brushing at the middle or stop halfway.
- Be careful not to touch the printing surface as much as possible.

3. To complete the removal of paper dust, brush the paper in the other direction from top to bottom.

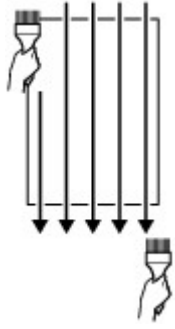



Printing Area

- ▶ **Printing Area**
- ▶ **Other Sizes than Letter or Legal**
- ▶ **Letter, Legal**
- ▶ **Sizes for Art Paper**
- ▶ **Printable Discs**

Printing Area

To ensure the best print quality, the printer allows a margin along each edge of media. The actual printable area will be the area inside these margins.

Recommended printing area  : Canon recommends that you print within this area.

Printable area  : The area where it is possible to print. However, printing in this area can affect the print quality or the paper feed precision.

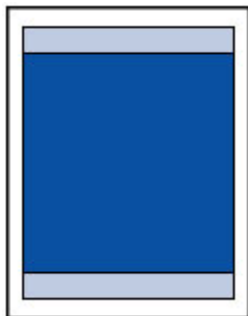

▶▶▶ Note

- By selecting Borderless Printing option, you can make prints with no margins.
- When performing Borderless Printing, slight cropping may occur at the edges since the printed image is enlarged to fill the whole page.
- For Borderless Printing, use the following paper:
 - Photo Paper Pro Platinum <PT-101>
 - Photo Paper Plus Glossy II <PP-201>
 - Photo Paper Pro Luster <LU-101>
 - Photo Paper Plus Semi-gloss <SG-201>
 - Matte Photo Paper <MP-101>

Performing Borderless Printing on any other type of paper may substantially reduce printing quality and/or result in printouts with altered color hues.

- Borderless Printing is not available for legal, 11" x 17" (279.4 x 431.8 mm), A5, B5, or B4 sized paper, plain paper, or art paper.
- Depending on the type of paper, Borderless Printing may reduce the print quality at the top and bottom edges of the paper or cause these parts to become smudged.

Other Sizes than Letter or Legal

Size	Printable Area (width x height)
A5	5.56 x 7.95 inches (141.2 x 202.0 mm)
A4	8.00 x 11.38 inches (203.2 x 289.0 mm)
A3	11.43 x 16.22 inches (290.2 x 412.0 mm)
A3+	12.69 x 18.70 inches (322.2 x 475.0 mm)
B5	6.90 x 9.80 inches (175.2 x 249.0 mm)
B4	9.85 x 14.02 inches (250.2 x 356.0 mm)
4" x 6" (10 x 15 cm)	3.73 x 5.69 inches (94.8 x 144.4 mm)
5" x 7" (13 x 18 cm)	4.73 x 6.69 inches (120.2 x 169.8 mm)
8" x 10" (20 x 25 cm)	7.73 x 9.69 inches (196.4 x 246.0 mm)
10" x 12" (25 x 30 cm)	9.73 x 11.69 inches (247.2 x 296.8 mm)
11" x 17" (279.4 x 431.8 mm)	10.73 x 16.69 inches (272.6 x 423.8 mm)
14" x 17" (36 x 43 cm)	13.73 x 16.69 inches (348.8 x 423.8 mm)

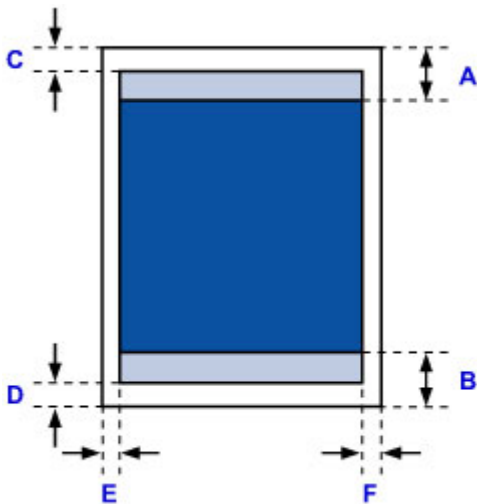

 Recommended printing area

A: 1.46 inches (37.0 mm)

B: 1.46 inches (37.0 mm)

 Printable area

C: 0.12 inch (3.0 mm)

D: 0.20 inch (5.0 mm)

E: 0.13 inch (3.4 mm)

F: 0.13 inch (3.4 mm)

Letter, Legal

Size	Printable Area (width x height)
Letter	8.00 x 10.69 inches (203.2 x 271.4 mm)
Legal	8.00 x 13.69 inches (203.2 x 347.6 mm)

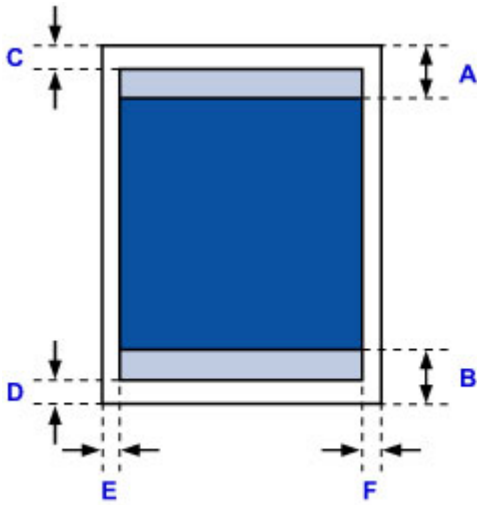

 Recommended printing area

A: 1.46 inches (37.0 mm)

B: 1.46 inches (37.0 mm)

 Printable area

C: 0.12 inch (3.0 mm)

D: 0.20 inch (5.0 mm)

E: 0.25 inch (6.4 mm)

F: 0.25 inch (6.3 mm)

Sizes for Art Paper

A limit is set to prevent printing along a 1.18 inch (30 mm) margin on the top and bottom edges when a page size for art paper is selected in the printer driver. We recommend checking the printing area in the preview screen before printing.

A4/A3/A3+/11" x 17" (279.4 x 431.8 mm)

Size	Recommended Printing Area (width x height)
A4 (art paper, 1.18 inch (30.0 mm) margin)	8.00 x 9.33 inches (203.2 x 237.0 mm)
A3 (art paper, 1.18 inch (30.0 mm) margin)	11.43 x 14.17 inches (290.2 x 360.0 mm)
A3+ (art paper, 1.18 inch (30.0 mm) margin)	12.69 x 16.65 inches (322.2 x 423.0 mm)
11" x 17" (279.4 x 431.8 mm) (art paper, 1.18 inch (30.0 mm) margin)	10.73 x 14.64 inches (272.6 x 371.8 mm)

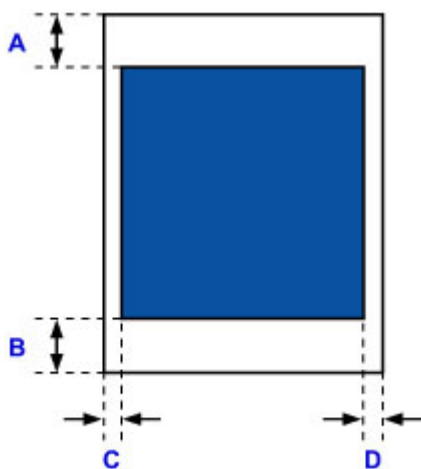

Recommended printing area

A: 1.18 inches (30.0 mm)

B: 1.18 inches (30.0 mm)

C: 0.13 inch (3.4 mm)

D: 0.13 inch (3.4 mm)

Letter

Size	Recommended Printing Area (width x height)
Letter (art paper, 1.18 inch (30.0 mm) margin)	8.00 x 8.64 inches (203.2 x 219.4 mm)

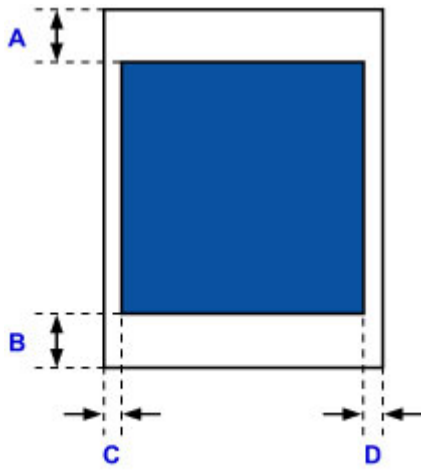

 Recommended printing area

A: 1.18 inches (30.0 mm)

B: 1.18 inches (30.0 mm)

C: 0.25 inch (6.4 mm)

D: 0.25 inch (6.3 mm)

Printable Discs

The printing area of the printable disc is from 0.67 inch (17 mm) of the internal diameter to 0.04 inch (1 mm) from the external diameter of the printing surface.

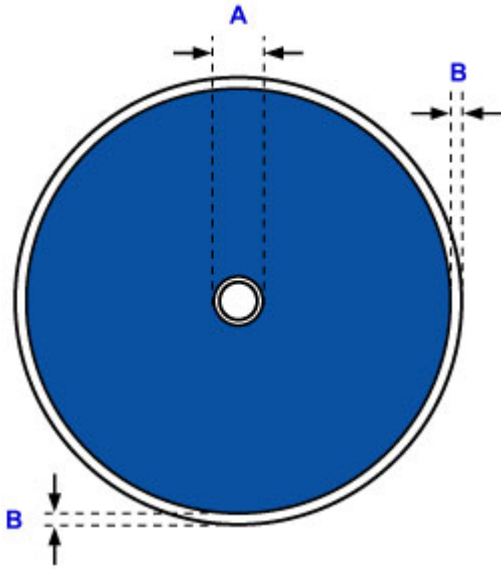

 Recommended printing area

A: 0.67 inch (17.0 mm)

B: 0.04 inch (1.0 mm)

Placing a Printable Disc

- ▶ **Cautions When Printing on a Printable Disc**
- ▶ **Before Placing a Printable Disc**
- ▶ **Placing a Printable Disc**
- ▶ **Removing a Printable Disc**

Cautions When Printing on a Printable Disc

- Be sure to use the disc tray supplied with this printer. It has a "K" on the upper side.
- Do not print on printable discs that are not compatible with inkjet printing. The ink will not dry and may cause problems with the disc itself or devices which the disc is loaded onto.
- Do not print on the printable discs' recording surface. Doing so will make data recorded on discs unreadable.
- Hold the printable discs by their edges. Do not touch either the label surface (printing surface) or recording surface.
- Remove any dirt from the disc tray before placing printable discs on the disc tray. Loading discs in a dirty disc tray may scratch the recording surface of the discs.
- After printing, allow the printing surface of the disc to dry naturally. Do not use hairdryers or expose the disc to direct sunlight to dry the ink. Do not touch the printing surface until the ink has dried.
- Do not attach the disc tray while the printer is in operation.
- Do not remove the disc tray while printing on printable discs. Doing so may damage the printer, the disc tray, or the disc.
- Do not get dirt or scratches on the reflectors of the disc tray. The printer may not be able to recognize loading of the printable disc, or printing may become misaligned. If the reflectors on the disc tray become dirty, wipe the reflector clean with a soft and dry cloth, taking care not to scratch the plate.
- The disc tray may become dirty if software other than My Image Garden is used.
- Always close the disc tray guide after printing on printable discs.

Before Placing a Printable Disc

The following items are needed to print onto the printable disc:

- disc tray (supplied with the printer)



* Use the disc tray with "K" on the surface.

The disc tray may be stored in the disc tray storage compartment in the bottom center of the printer.

■ [Storing the disc tray](#)

- 4.72 inches (12 cm) printable disc



Obtain a printable disc with a label surface compatible with inkjet printing.

▶▶▶ **Note**

- A "printable disc" differs from regular disc (BD/DVD/CD, etc.) in that its label surface has been specially processed to be printed on by an inkjet printer.

Placing a Printable Disc

To print onto a printable disc, place it on the disc tray supplied with the printer, then insert it into the printer.

▶▶▶ Important

- Do not attach the disc tray until the message asking you to load the printable disc is displayed. Doing so can damage the printer.
- Remove any paper in the manual feed tray.

1. Open the paper output tray (A) gently.
2. When the message asking you to load the printable disc is displayed, open the disc tray guide (B).

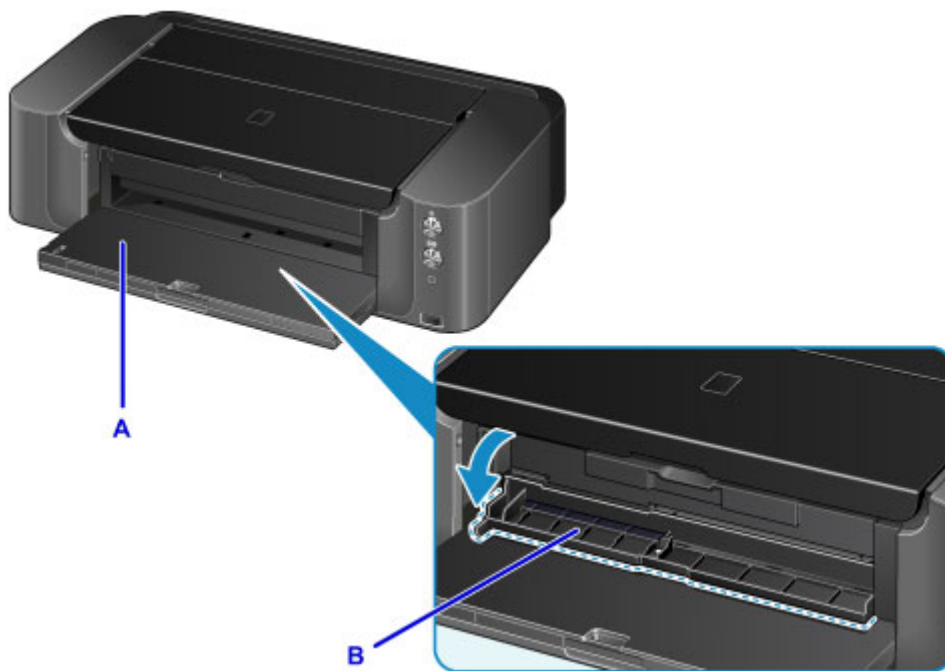

3. Place the printable disc with the printable surface facing up.

▶▶▶ Important

- Make sure that there is no dirt on the disc tray before placing a printable disc on the disc tray.
- When placing a printable disc on the disc tray, do not touch the printing surface of the disc or the reflectors (C) on the disc tray.

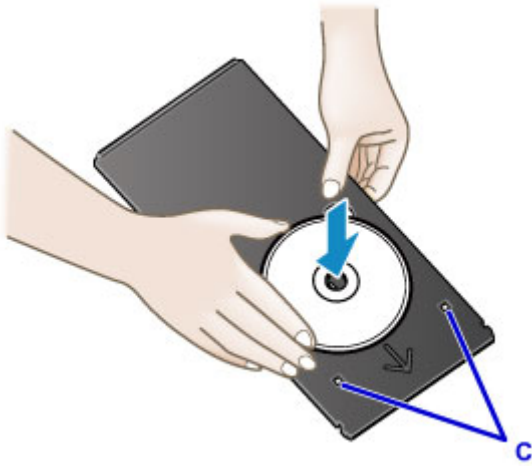

4. Place the disc tray on the disc tray guide.

▶▶▶ Important

- Do not attach the disc tray while the printer is operating (the **POWER** lamp is flashing).

▶▶▶ Note

- The disc tray may be ejected during preparation by the printer for printing. Wait until the **POWER** lamp stays lit after flashing, then follow the on-screen instructions to attach the disc tray.

5. Insert the disc tray straight until the arrow (◀) on the disc tray guide is almost aligned with the arrow (▶) on the disc tray.

▶▶▶ Important

- Do not insert the disc tray beyond the arrow (◀) on the disc tray guide.

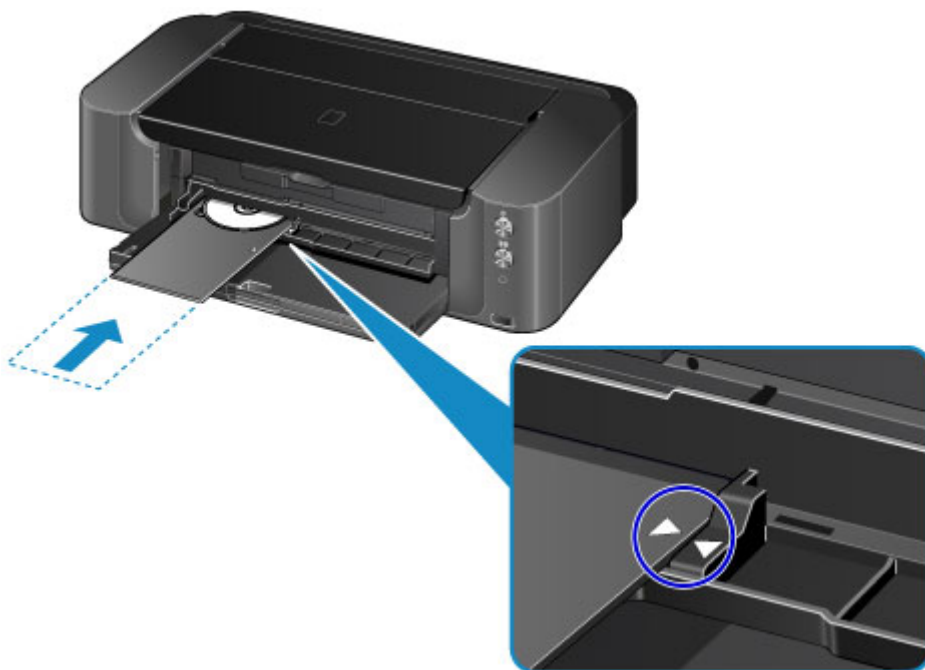

Removing a Printable Disc

1. Pull out the disc tray.



2. Close the disc tray guide.

▶▶▶ Important

- If the disc tray guide is opened, you cannot print on paper as it will not feed properly. Make sure that the disc tray guide is closed.

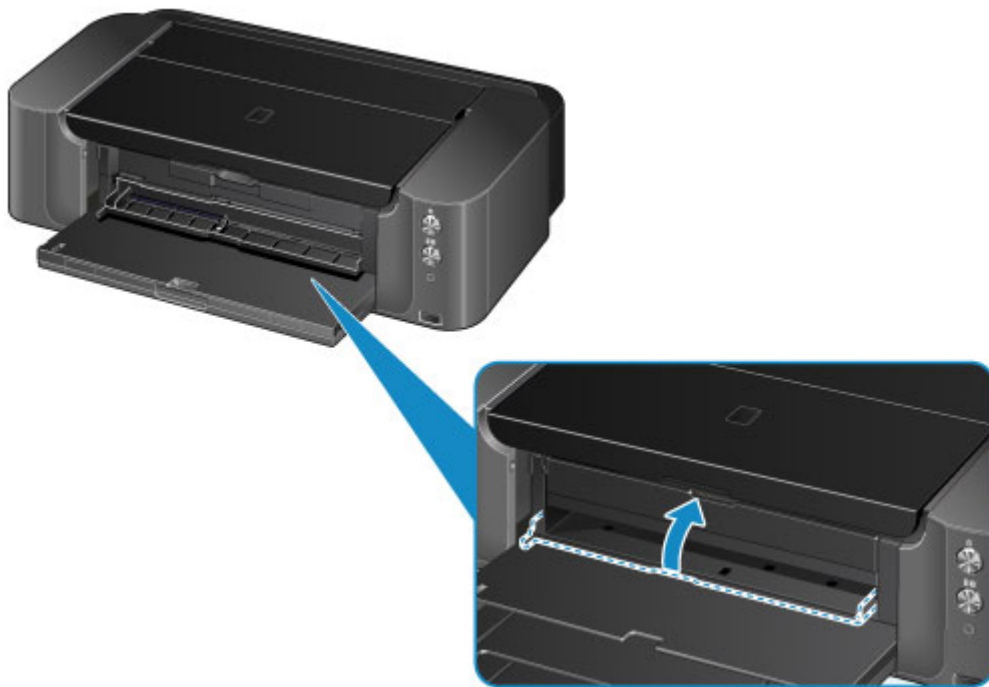

3. Remove the printable disc from the disc tray.

▶▶▶ Important

- Do not touch the printing surface when removing the disc from the disc tray.

▶▶▶ Note

- Dry the printing surface sufficiently before removing the disc. If you see printing on the disc tray or the transparent parts on inner or outer diameter of the printable disc, wipe them off after the printing surface has dried.

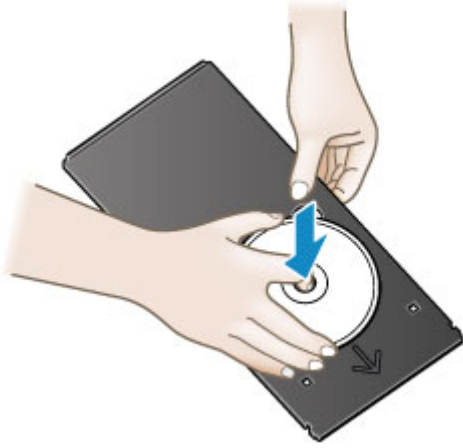

Storing the disc tray

When not using the disc tray, insert it straight into the disc tray storage compartment in the bottom center of the printer.



►► Important

- If the disc tray is bent, it may become unusable. Always keep it on a flat place.

Replacing an Ink Tank

- ▶ [Replacing an Ink Tank](#)
- ▶ [Checking the Ink Status](#)

Replacing an Ink Tank

When remaining ink cautions or errors occur, the **Alarm** lamp will flash to inform you of the error. Count the number of flashes and take appropriate action.

■ [If an Error Occurs](#)

▶▶▶ Important

- Prepare a new ink tank before you start replacing one.
- Replace the ink tank quickly so as not to leave the printer without an ink tank.
- The printer may be damaged if it is left without an ink tank, causing a problem such as clogging due to dried ink.

▶▶▶ Note

- If print results become faint or white streaks appear despite sufficient ink levels, see [Maintenance Procedure](#).
- For precautionary notes on handling ink tanks, see [Notes on ink tanks](#).

Replacing Procedure

When you need to replace an ink tank, follow the procedure below.

1. Make sure that the power is turned on, and open the paper output tray gently.
2. Open the top cover, then press the **RESUME/CANCEL** button.

The print head holder (A) moves to the replacement position.



⚠ Caution

- Do not hold the print head holder to stop or move it forcibly. Do not touch the print head holder until it stops completely.

▶▶▶ Important

- Do not place any object on the top cover. It will fall into the rear tray when the top cover is opened and cause the printer to malfunction.
- Do not touch the metallic parts or other parts inside the printer.
- If more than 10 minutes elapse after the **RESUME/CANCEL** button is pressed, the print head holder moves to the right. In this case, close and reopen the top cover, then press the **RESUME/CANCEL** button.

3. Take a new ink tank out of its package.

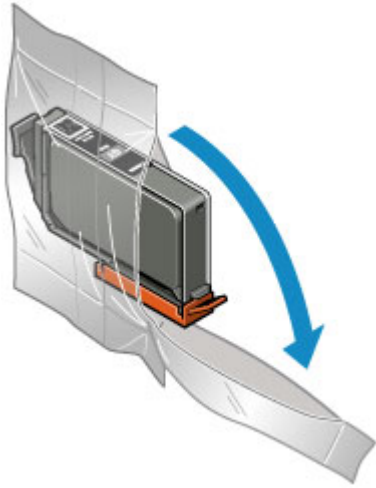

►► Important

- Handle an ink tank carefully. Do not drop or apply excessive pressure to it.

4. Remove the orange protective cap (B) from the bottom of the ink tank as indicated in the figure below.

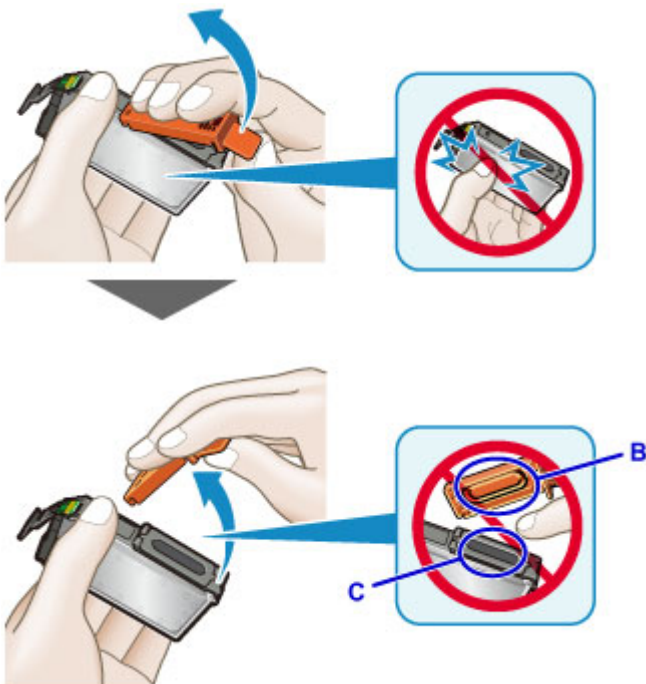

►► Important

- Do not push the sides of the ink tank. If you push the sides of the ink tank, ink may splash.
- Do not touch the inside of the protective cap (B) or the open ink port (C). The ink may stain your hands if you touch them.
- Do not reattach the protective cap (B) once you have removed it. Discard it according to the local laws and regulations regarding disposal of consumables.

5. Remove the ink tank with the lamp flashing fast.

Push the tab (D) and lift the ink tank to remove.

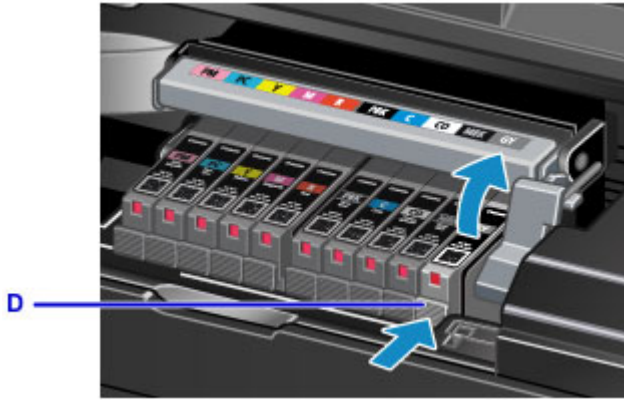

►► Important

- Do not touch other parts besides the ink tanks.
- Handle the ink tank carefully to avoid staining of clothing or the surrounding area.
- Discard the empty ink tank according to the local laws and regulations regarding disposal of consumables.

►► Note

- Do not remove two or more ink tanks at the same time. Be sure to replace ink tanks one by one when replacing two or more ink tanks.
- For details on ink lamp flashing speed, see [Checking the Ink Status with the Ink Lamps](#).

6. Insert the front end of the ink tank into the print head at a slant.

Make sure that the position of the ink tank matches the label.

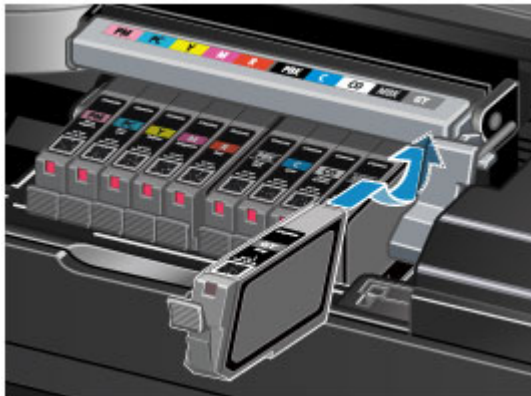

7. Press on the top of the ink tank until the ink tank snaps firmly into place.

Make sure that the ink lamp lights up.



►► Important

- You cannot print if the ink tank is installed in the wrong position. Be sure to install the ink tank in the correct position according to the label on the print head holder.
- You cannot print unless all the ink tanks are installed. Be sure to install all the ink tanks.

8. Close the top cover.

The printer will automatically start mixing the ink. Wait until the **POWER** lamp stays lit after flashing and the printer stops making operating noise (it takes up to about 2 minutes or less).

►► Note

- If the **Alarm** lamp still flashes after the top cover is closed, take appropriate action.
 - [If an Error Occurs](#)
- When you start printing after replacing the ink tank, the printer starts cleaning the print head automatically. Do not perform any other operations until the printer completes the cleaning of the print head. While cleaning is in progress, the **POWER** lamp is flashing.
- If the print head is out of alignment, as indicated by misaligned printed ruled lines or similar symptoms, [align the print head](#).

Notes on ink tanks

►► Important

- Use a new ink tank for replacement. Installing a used ink tank may cause the nozzles to clog. Furthermore, with such an ink tank, the printer will not be able to inform you when to replace the ink tank properly.
- Once an ink tank has been installed, do not remove it from the printer and leave it out in the open. This will cause the ink tank to dry out, and the printer may not operate properly when it is reinstalled. To maintain optimal printing quality, use an ink tank within six months of first use.

►► Note

- Color ink may be consumed even when printing a black-and-white document or when black-and-white printing is specified. Every ink is also consumed in the standard cleaning and deep cleaning of the print head, which may be necessary to maintain the performance of the printer.

When an ink tank is out of ink, replace it immediately with a new one.

- [Useful Information about Ink](#)

Checking the Ink Status

- ▶ **Checking the Ink Status with the Ink Lamps**

You can also check the ink status on the computer screen.

- ▶ **Checking the Ink Status from Your Computer**

Checking the Ink Status with the Ink Lamps

1. Make sure that the power is turned on, and open the paper output tray gently.
2. Open the top cover, then press the **RESUME/CANCEL** button.

■ [Replacing Procedure](#)

3. Check the ink lamp.

Close the top cover after checking the ink lamp status.

■ [Replacing Procedure](#)

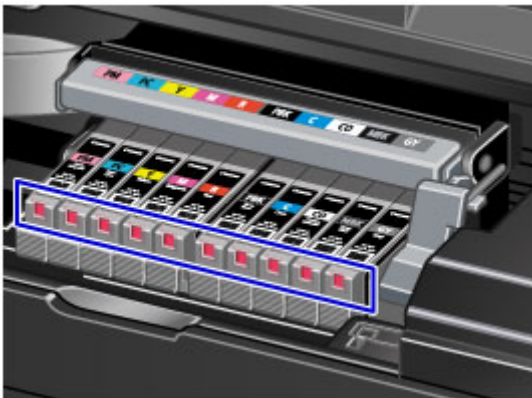

- The ink lamp is on.
The ink tank is correctly installed.
- The ink lamp is flashing.

Flashing slowly (at around 3-second intervals)



Ink tank is running low. Prepare a new ink tank.

▶▶ Note

- When printing on A3 size or larger paper, ink may run out during printing. This may cause blurred print results or horizontal white streaks.

Flashing fast (at around 1-second intervals)



- The ink tank is installed in the wrong position.

Or

- Printer detected ink out condition.

Make sure that the ink tank is installed in the correct position as indicated by the label on the print head holder. If the position is correct but the lamp flashes, there has been an error and the printer cannot print. Check the **Alarm** lamp on the printer.

■ [If an Error Occurs](#)

- The ink lamp is off.

The ink tank is not installed properly or the function for detecting the remaining ink level is disabled. If the ink tank is not firmly in place, make sure that the orange protective cap has been removed from the bottom of the ink tank, then press on the top of the ink tank until the ink tank clicks into place.

If the ink lamp is still off after reinstalling the ink tank, there has been an error and the printer cannot print. Check the **Alarm** lamp on the printer.

■ [If an Error Occurs](#)

▶▶▶ Note

- You can also check the ink status on the computer screen.

■ [Checking the Ink Status from Your Computer](#)

Maintenance

- **When Printing Becomes Faint or Colors Are Incorrect**
- **Performing Maintenance from a Computer**
- **Cleaning the Printer**

When Printing Becomes Faint or Colors Are Incorrect

- **Maintenance Procedure**
- **Printing the Nozzle Check Pattern**
- **Examining the Nozzle Check Pattern**
- **Cleaning the Print Head**
- **Aligning the Print Head**

Maintenance Procedure

If print results are blurred, colors are not printed correctly, or print results are unsatisfactory (e.g. misaligned printed ruled lines), perform the maintenance procedure below.

►►► Important

- Do not rinse or wipe the print head and ink tank. This can cause trouble with the print head and ink tank.

►►► Note

- Open the top cover and make sure that the lamp on the ink tank is lit. If the lamp is flashing or off, take appropriate action.
 - [Checking the Ink Status with the Ink Lamps](#)
- If print results are uneven, the ink quality maintenance with the printer driver may improve print quality.
 - [Maintaining the Ink Quality](#)
- Increasing the print quality in the printer driver settings may improve the print result.
 - [Changing the Print Quality and Correcting Image Data](#)

When the Print Results Are Blurred or Uneven:

|| Step1 | Print the nozzle check pattern.

From the printer

- [Printing the Nozzle Check Pattern](#)

From the computer

- [Use Your Computer to Print a Nozzle Check Pattern](#)

|| Step2 | [Examine the nozzle check pattern.](#)

If there are horizontal streaks in the pattern:



|| Step3 | Clean the print head.

From the printer

- [Cleaning the Print Head](#)

From the computer

- [Cleaning the Print Heads from Your Computer](#)

After cleaning the print head, print and examine the nozzle check pattern: ➔ [Step1](#)

If the problem is not resolved after performing from step 1 to step 3 twice:



|| Step4 | Clean the print head deeply.

From the computer

■ [Cleaning the Print Heads from Your Computer](#)

▶▶▶ Note

- When you have performed the procedure until step 4 and the problem has not been resolved, turn off the power and clean the print head deeply again after 24 hours.

If the problem is still not resolved, the print head may be damaged. Contact the service center.

When the Print Results Are Not Even such as the Ruled Lines Are Misaligned:

|| Step | Align the print head.

From the printer

■ [Aligning the Print Head](#)

From the computer

■ [Aligning the Print Head Position from Your Computer](#)

Printing the Nozzle Check Pattern

Print the nozzle check pattern to determine whether the ink ejects properly from the print head nozzle.

▶▶▶ Note

- If the remaining ink level is low, the nozzle check pattern will not be printed correctly. [Replace the ink tank](#) whose ink is low.

You need to prepare: a sheet of A4 or Letter-sized plain paper

1. Make sure that the power is turned on.
2. Load a sheet of A4 or Letter-sized plain paper in the rear tray.

▶▶▶ Important

- The manual feed tray is not available for the nozzle check pattern print procedure. Be sure to load paper in the rear tray.

3. Open the paper output tray gently, then pull out the output tray extension.

▶▶▶ Important

- If the disc tray guide is open, be sure to close it.

4. Hold down the **RESUME/CANCEL** button until the **POWER** lamp flashes twice, then release it immediately.

The nozzle check pattern will be printed.

Do not perform any other operations until the printer completes the printing of the nozzle check pattern.

5. [Examine the nozzle check pattern.](#)

Examining the Nozzle Check Pattern

Examine the nozzle check pattern, and clean the print head if necessary.

1. Check if there are horizontal streaks in the pattern (A) and pattern (B).

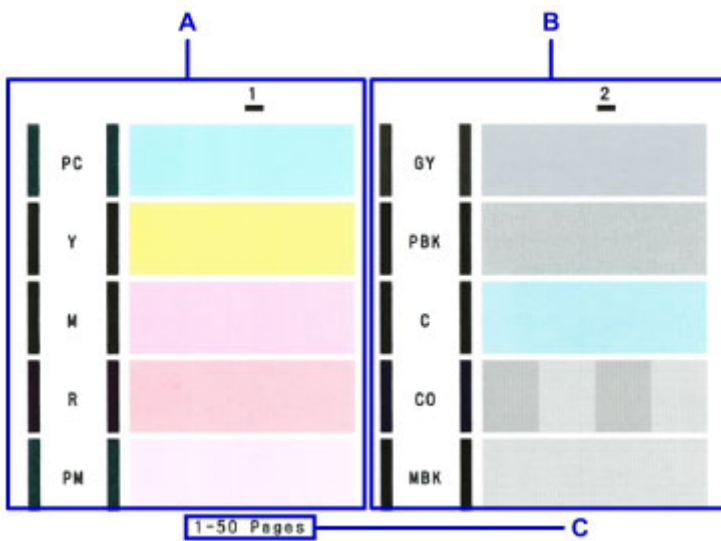

C: Number of sheets printed so far

If there are horizontal streaks in the pattern A:

Cleaning the nozzles of the ink group 1 (PC, Y, M, R, or PM) is required.

Select the ink group to clean using the computer.

■ [Cleaning the Print Heads from Your Computer](#)



D: Good

E: Bad (horizontal streaks are present)

If there are horizontal streaks in the pattern B:

Cleaning the nozzles of the ink group 2 (GY, PBK, C, CO, or MBK) is required.

Select the ink group to clean using the computer.

■ [Cleaning the Print Heads from Your Computer](#)

►► Note

- Because CO ink is colorless, its pattern is printed over the MBK ink pattern. Check for horizontal streaks (F) in the dark gray bands of the pattern.

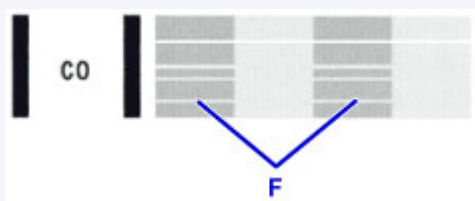

If there are horizontal streaks in both the pattern A and pattern B:

Cleaning the nozzles of all ink colors is required.

From the printer

■ [Cleaning the Print Head](#)

From the computer

■ [Cleaning the Print Heads from Your Computer](#)

»» Note

- The total number of sheets printed so far is shown in increments of 50 sheets on the printout of the nozzle check pattern.

Cleaning the Print Head

Clean the print head if horizontal streaks are present in the printed nozzle check pattern. Cleaning unclogs the nozzles and restores the print head condition. Cleaning the print head consumes ink, so clean the print head only when necessary.

▶▶▶ Note

- You can also clean the print head using the computer. When using the computer, select the ink group to clean, then start cleaning.
 - [Cleaning the Print Heads from Your Computer](#)
- When cleaning the print head using the button on the printer, the nozzles of all ink colors are cleaned.

1. Make sure that the power is turned on.

2. Hold down the **RESUME/CANCEL** button until the **POWER** lamp flashes once, then release it immediately.

The printer starts cleaning the print head.

The cleaning will be complete when the **POWER** lamp lights after flashing.

Do not perform any other operations until the printer completes the cleaning of the print head. This takes about 2 to 3 minutes.

3. Check the print head condition.

[Print the nozzle check pattern](#) to check the print head condition.

▶▶▶ Note

- If the problem is not resolved after cleaning the print head twice, clean the print head deeply.
 - [Cleaning the Print Heads from Your Computer](#)

Aligning the Print Head

If printed ruled lines are misaligned or print results are otherwise unsatisfactory, adjust the print head position.

▶▶▶ Note

- If the remaining ink level is low, the print head alignment sheet will not be printed correctly. [Replace the ink tank](#) whose ink is low.

You need to prepare: two sheets of A4 or Letter-sized plain paper (including recycled paper)*

* Be sure to use paper that is white and clean on both sides.

1. Make sure that the power is turned on.
2. Load two sheets of A4 or Letter-sized plain paper in the rear tray.

▶▶▶ Important

- The manual feed tray is not available for the print head alignment procedure. Be sure to load paper in the rear tray.

3. Open the paper output tray gently, then pull out the output tray extension.

▶▶▶ Important

- If the disc tray guide is open, be sure to close it.

4. Hold down the **RESUME/CANCEL** button until the **POWER** lamp flashes four times, then release it immediately.

The print head alignment sheet will be printed and the print head position will be adjusted automatically.

Do not perform any other operations until the printer completes the printing of the print head alignment sheet. This takes about 5 to 6 minutes.

▶▶▶ Note

- If the automatic adjustment of the print head position has failed, the **Alarm** lamp flashes.
 - [If an Error Occurs](#)
- If the print results are still not satisfactory after adjusting the print head position as described above, adjust the print head position manually from the computer.
 - [Aligning the Print Head Position Manually from Your Computer](#)

Performing Maintenance from a Computer

- **Cleaning the Print Heads from Your Computer**
- **Cleaning Inside the Printer**
- **Cleaning the Paper Feed Rollers from Your Computer**
- **Use Your Computer to Print a Nozzle Check Pattern**
- **Aligning the Print Head**
- **Aligning the Print Head Position from Your Computer**
- **Maintaining the Ink Quality**
- **Checking the Ink Status from Your Computer**

Cleaning the Print Heads from Your Computer

The print head cleaning function allows you to clear up clogged print head nozzle. Perform print head cleaning if printing is faint or a specific color fails to print, even though there is enough ink.

The procedure for cleaning the print head is as follows:



Cleaning

1. Select **Cleaning** from the pop-up menu on the [Canon IJ Printer Utility](#)

2. Click the **Cleaning** icon

When the dialog opens, select the ink group for which cleaning is to be performed.

Click  to display the items you need to check before performing cleaning.

3. Execute cleaning

Make sure that the printer is on and then click **OK**.

Print head cleaning starts.

4. Complete cleaning

The **Nozzle Check** dialog opens after the confirmation message.

5. Check the results

To check whether the print quality has improved, click **Print Check Pattern**. To cancel the check process, click **Cancel**.

If cleaning the head once does not resolve the print head problem, clean it once more.

»» Important

- **Cleaning** consumes a small amount of ink.
Cleaning the print head frequently will rapidly deplete your printer's ink supply. Consequently, perform cleaning only when necessary.



Deep Cleaning

Deep Cleaning is more thorough than cleaning. Perform deep cleaning when two **Cleaning** attempts do not resolve the print head problem.

1. Select **Cleaning** from the pop-up menu on the [Canon IJ Printer Utility](#)

2. Click the **Deep Cleaning** icon

When the dialog opens, select the ink group for which deep cleaning is to be performed.

Click  to display the items you need to check before performing deep cleaning.

3. Execute deep cleaning

Make sure that the printer is on and then click **OK**.
Click **OK** when the confirmation message appears.
Print head deep cleaning starts.

4. Complete deep cleaning

The **Nozzle Check** dialog opens after the confirmation message.

5. Check the results

To check whether the print quality has improved, click **Print Check Pattern**. To cancel the check process, click **Cancel**.

»» Important

- **Deep Cleaning** consumes a larger amount of ink than **Cleaning**.
Cleaning the print head frequently will rapidly deplete your printer's ink supply. Consequently, perform cleaning only when necessary.

»» Note

- If there is no sign of improvement after **Deep Cleaning**, turn off the printer, wait 24 hours, and then perform **Deep Cleaning** again. If there is still no sign of improvement, the ink may have run out or the print head may be worn. For details on the remedial action to be taken, see "[Ink Is Not Ejected](#)."

Related Topic

- [Use Your Computer to Print a Nozzle Check Pattern](#)

Cleaning Inside the Printer

To prevent smudges on the back side of the paper, perform bottom plate cleaning.

Also perform bottom plate cleaning if ink smudges caused by something other than print data appear on the printed page.

The procedure for performing bottom plate cleaning is as follows:



Bottom Plate Cleaning

1. Select **Cleaning** from the pop-up menu on the [Canon IJ Printer Utility](#)

2. Click the **Bottom Plate Cleaning** icon

The dialog opens.

3. Load paper in the printer

As instructed in the dialog, fold the A4 size or Letter size plain paper in half lengthwise, and then unfold the sheet.

Load the paper into the rear tray in the landscape orientation with the crest of the crease facing down.

4. Perform the bottom plate cleaning

Make sure that the printer is on and then click **OK**.

Bottom plate cleaning starts.

Cleaning the Paper Feed Rollers from Your Computer

Cleans the paper feed rollers. Perform feed roller cleaning when there are paper particles sticking to the paper feed rollers and paper is not fed properly.

The procedure for performing the feed roller cleaning is as follows:



Roller Cleaning

1. Prepare the printer

Remove all sheets of paper from the paper source from which paper could not be properly fed.

2. Select **Cleaning** from the pop-up menu on the [Canon IJ Printer Utility](#)

3. Click the **Roller Cleaning** icon

A message appears.

4. Select **Rear Tray** or **Manual Feed Tray**, and then click **OK**

The confirmation message appears.

5. Execute paper feed roller cleaning

Make sure that the printer is on and then click **OK**.

Paper feed roller cleaning starts.

6. Complete paper feed roller cleaning

Follow the instructions in the message, load plain paper into the selected paper source, and then click **OK**.

Paper will be ejected and feed roller cleaning will be completed.

Use Your Computer to Print a Nozzle Check Pattern

The nozzle check function allows you to check whether the print head is working properly by printing a nozzle check pattern. Print the pattern if printing becomes faint, or if a specific color fails to print.

The procedure for printing a nozzle check pattern is as follows:



Nozzle Check

1. Select **Test Print** from the pop-up menu on the [Canon IJ Printer Utility](#)

2. Click the **Nozzle Check** icon

The confirmation message appears.

Click  to display the items that you need to check before printing the nozzle check pattern.

3. Load paper in the printer

Load one sheet of A4 size or Letter size plain paper into the rear tray.

4. Print a nozzle check pattern

Make sure that the printer is on and click **Print Check Pattern**.

Printing of the nozzle check pattern begins.

5. Check the print result

When the dialog opens, check the print result. If the print result is normal, click **Quit**.

If the print result is smudged or if there are any unprinted sections, click **Cleaning** to clean the print head.

Related Topic

- [Cleaning the Print Heads from Your Computer](#)

Aligning the Print Head

When you perform head position adjustment, errors in the print head adjustment position are corrected and conditions such as color and line streaking are improved.

If the print results appear uneven because of line shifts or other conditions, adjust the position of the print head.

On this printer, you can adjust the print head either [automatically](#) or [manually](#).

Aligning the Print Head Position from Your Computer

Print head alignment corrects the installation positions of the print head and improves deviated colors and lines.

This printer supports two head alignment methods: automatic head alignment and manual head alignment. Normally, the printer is set for automatic head alignment.

If the printing results of automatic print head alignment are not satisfactory, [perform manual head alignment](#).

The procedure for performing automatic print head alignment is as follows:

▶▶▶ Note

- If the disc tray guide is open, close it.



Print Head Alignment

1. Select **Test Print** from the pop-up menu on the [Canon IJ Printer Utility](#)
2. Click the **Print Head Alignment** icon

A message is displayed.

3. Load paper in the printer

Load two sheets of A4 size or Letter size plain paper into the rear tray.

▶▶▶ Note

- Depending on the condition of the printer, you may need to use 3 sheets of A4 size or Letter size plain paper.
- The number of sheets to be used differs when you select the manual head alignment.

4. Execute head alignment

Make sure that the printer is on and click **Align Print Head**.

Print head alignment starts.

▶▶▶ Important

- Do not open the top cover while printing is in progress.

▶▶▶ Note

- Wait until printing ends before performing other operations. Printing takes about 5 to 6 minutes to complete.

▶▶▶ Note

- After head alignment is completed, you can print and check the current setting. To do so, click the **Print Head Alignment** icon and when the message is displayed, click **Print Alignment Value**.

Aligning the Print Head Position Manually from Your Computer

Print head alignment corrects the installation positions of the print head and improves deviated colors and lines.

This printer supports two head alignment methods: [automatic head alignment](#) and manual head alignment. Normally, the printer is set for automatic head alignment.

If the printing results of automatic print head alignment are not satisfactory, perform manual head alignment.

The procedure for performing manual print head alignment is as follows:

▶▶▶ Note

- If the disc tray guide is open, close it.



Print Head Alignment

1. Select **Custom Settings** from the pop-up menu on the [Canon IJ Printer Utility](#)
2. Switch head alignment to manual
Check the **Align heads manually** check box.
3. Apply the settings
Click **Apply** and when the confirmation message appears, click **OK**.
4. Select **Test Print** from the pop-up menu on the Canon IJ Printer Utility
5. Click the **Print Head Alignment** icon
A message is displayed.
6. Load paper in the printer
Load three sheets of A4 size or Letter size plain paper into the rear tray.

▶▶▶ Note

- Depending on the condition of the printer, you may need to use 4 sheets of A4 size or Letter size plain paper.

7. Execute head alignment

Make sure that the printer is on and click **Align Print Head**.
The first pattern is printed.

▶▶▶ Important

- Do not open the top cover while printing is in progress.

8. Check the printed pattern

Enter the numbers of the patterns with the least amount of streaks in the associated boxes, and click **OK**.



▶▶▶ Note

- If it is difficult to pick the best pattern, pick the setting that produces the least noticeable vertical streaks.

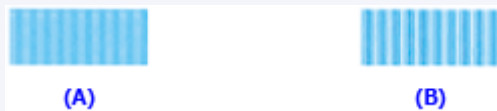

- (A) Least noticeable vertical streaks
- (B) Most noticeable vertical streaks

9. Confirm the displayed message and click **OK**

The second pattern is printed.

▶▶▶ Important

- Do not open the top cover while printing is in progress.

10. Check the printed pattern

Enter the numbers of the patterns with the least amount of streaks in the associated boxes, and click **OK**.

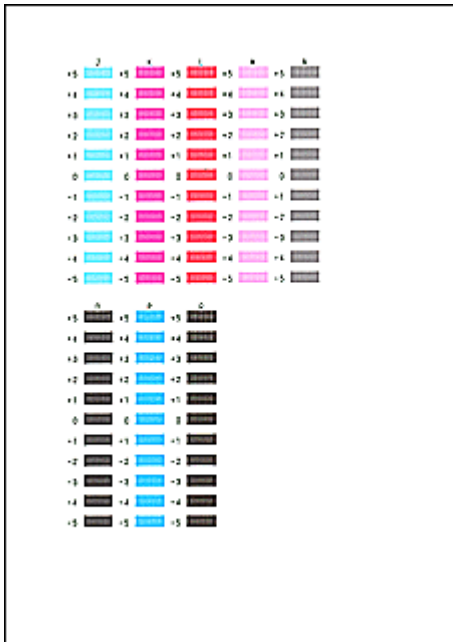

➤➤ **Note**

- If it is difficult to pick the best pattern, pick the setting that produces the least noticeable vertical streaks.

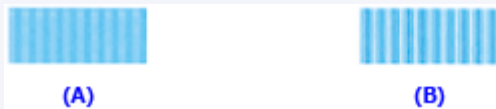

(A) Least noticeable vertical streaks

(B) Most noticeable vertical streaks

11. Confirm the displayed message and click **OK**

The third pattern is printed.

➤➤ **Important**

- Do not open the top cover while printing is in progress.

12. Check the printed pattern

Enter the numbers of the patterns with the least noticeable streaks in the associated boxes, and click **OK**.

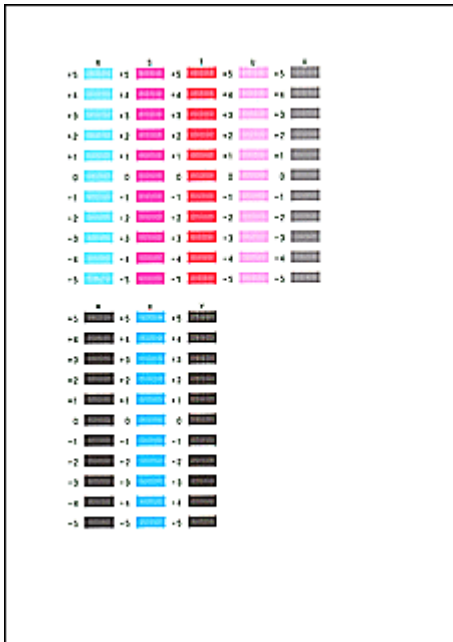

➤➤➤ **Note**

- If it is difficult to pick the best pattern, pick the setting that produces the least noticeable vertical streaks.

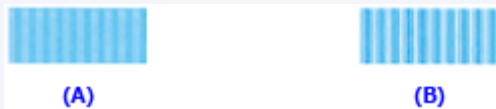

- (A) Least noticeable vertical streaks
- (B) Most noticeable vertical streaks

13. To execute remaining adjustments

If a confirmation message is displayed, click **OK**.

➤➤➤ **Note**

- After head alignment is completed, you can print and check the current setting. To do so, click the **Print Head Alignment** icon and when the message is displayed, click **Print Alignment Value**.

Maintaining the Ink Quality

This printer automatically mixes the ink at fixed intervals to keep the ink density even.

You can also disable this function by unchecking the **Execute ink quality maintenance automatically** check box in **Custom Settings** of the Canon IJ Printer Utility pop-up menu. You should check this check box when using the printer.

Note that the ink density may become uneven when this setting is disabled. Therefore, when you disable this setting, be sure to execute the following operation about once a week.

The procedure for executing ink quality maintenance manually is as follows:



Ink Quality Maintenance

1. Select **Test Print** from the pop-up menu on the [Canon IJ Printer Utility](#)
2. Click **Ink Quality Maintenance**
Click **OK** when a message appears.

Cleaning the Printer

- **Cleaning the Exterior of the Printer**
- **Cleaning the Paper Feed Roller**
- **Cleaning the Inside of the Printer (Bottom Plate Cleaning)**

Cleaning the Exterior of the Printer

Be sure to use a soft and dry cloth such as eyeglasses cleaning cloth and wipe off dirt on the surface gently. Smooth out wrinkles on the cloth if necessary before cleaning.

»» Important

- Be sure to turn off the power and unplug the power cord before cleaning the printer.
- Do not use tissue paper, paper towels, rough-textured cloth, or similar materials for cleaning so as not to scratch the surface. Paper tissue powder or fine threads may remain inside the printer and cause problems such as print head blockage and poor printing results.
- Never use volatile liquids such as thinners, benzene, acetone, or any other chemical cleaner to clean the printer, as this may cause a malfunction or damage the surface of the printer.

Cleaning the Paper Feed Roller

If the paper feed roller is dirty or paper powder is attached to it, paper may not be fed properly.

In this case, perform the paper feed roller cleaning from the computer. Cleaning will wear out the paper feed roller, so perform this only when necessary.

■ [Cleaning the Paper Feed Rollers from Your Computer](#)

If the problem is not resolved after cleaning the paper feed roller from the computer, turn off the power, unplug the power cord, then wipe the paper feed roller parts (the large paper feed roller in the center and three rollers on each side of it) (A) located in the rear tray with a moistened cotton swab or the like. Do not touch the paper feed roller (B) with your fingers. Wipe the paper feed roller parts with a cotton swab while turning the shaft (C) with your fingers.

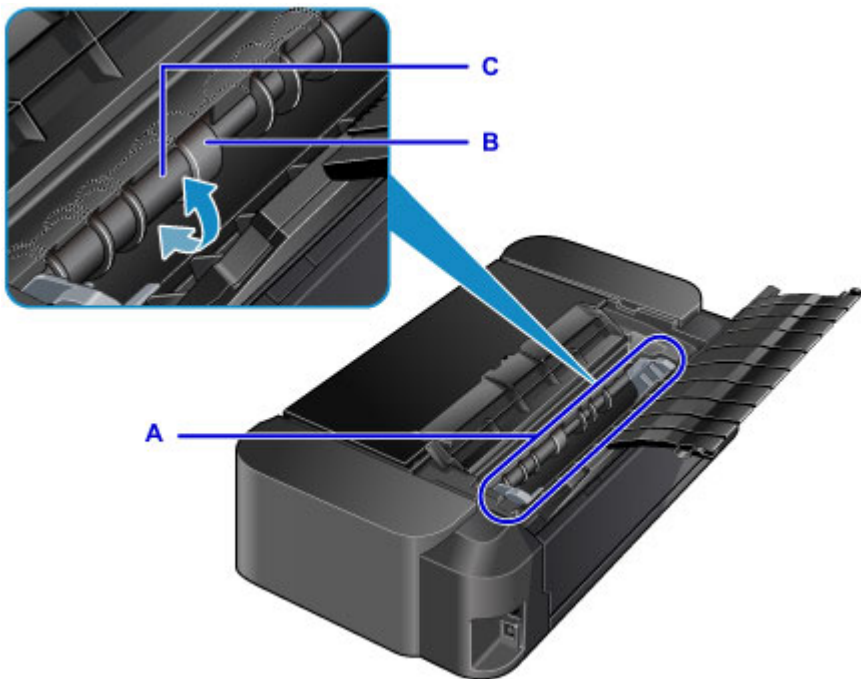

After cleaning the paper feed roller parts with a cotton swab, turn on the power, then clean the paper feed roller from the computer again.

If the problem is not resolved after cleaning the paper feed roller, contact the service center.

Cleaning the Inside of the Printer (Bottom Plate Cleaning)

If the inside of the printer becomes dirty, printed paper may get dirty, so we recommend performing cleaning regularly. When printed paper gets dirty, perform Bottom Plate Cleaning from the computer.

■ [Cleaning Inside the Printer](#)

If the problem is not resolved after performing Bottom Plate Cleaning, the protrusions inside the printer may be stained. Wipe off any ink from the protrusions using a cotton swab or the like.

▶▶▶ Important

- Be sure to turn off the power and unplug the power cord before cleaning the printer.



Changing the Printer Settings

- ▶ **Changing Printer Settings from Your Computer**
- ▶ **Initializing the Printer Settings**
- ▶ **Disabling the LAN Function of the Printer**

Changing Printer Settings from Your Computer

- **Checking the Ink Status from Your Computer**
- **Registering a Changed Printing Profile**
- **Managing the Printer Power**
- **Reducing the Printer Noise**
- **Changing the Printer Operation Mode**

Checking the Ink Status from Your Computer

You can check the detailed information such as the remaining ink level and the ink tank types of your model.

1. Select **Ink Level Information** from the pop-up menu on the [Canon IJ Printer Utility](#)

An illustration of the ink types and their status is displayed.

If a warning or error related to the remaining ink level occurs, the printer driver displays an icon to let you know.

2. If necessary, click **Ink Details**

You can check the ink-related information.

▶▶ Note

- **Ink Details** is displayed when the ink level is low.
- Click  to check which ink tank your model uses.
- Click **Update** to display the current remaining ink level.
- When you receive a notice about the remaining ink level, a mark appears above the ink icon.

For example: 

Ink tank is running low. Prepare a new ink tank.

- When you print on A3 paper or larger paper sizes, the ink may run out before printing is finished or the printing may become faint or streaky (with white lines).

Registering a Changed Printing Profile

You can name and register the printing profile you made in the [Print Dialog](#). The registered printing profile can be called up from **Presets** to be used. You can also delete the unnecessary printing profile.

The procedure for registering a printing profile is as follows:

Registering a Printing Profile

1. In the Print dialog, set the necessary items
2. Select **Save Current Settings as Preset...** from the **Presets**

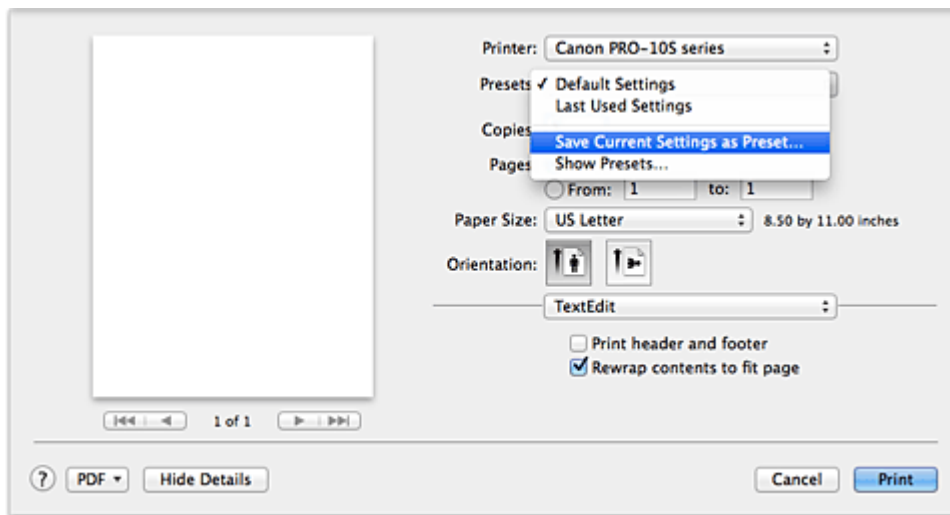

3. Save the settings

In the displayed dialog, enter a name in **Preset Name**, and if necessary, set **Preset Available For**. Then click **OK**.

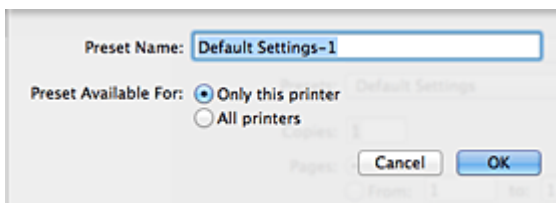

Important

- There are also print settings that cannot be saved to preset.

Using Registered Printing Profile

1. On **Presets** in the Print dialog, select the name of printing profile you want to use
Printing profile in the Print dialog will be updated to the called profile.

Deleting Unnecessary Printing Profile

1. Select the printing profile to be deleted

In the print dialog, select **Show Presets...** in the **Presets** section. Then in the dialog that appears, select the name of the printing profile to be deleted.

2. Delete the printing profile

Click **Delete**, and click **OK**. The selected printing profiles will be deleted from **Presets**.

Managing the Printer Power

This function allows you to manage the printer power from the printer driver.

The procedure for managing the printer power is as follows:



Power Off

The **Power Off** function turns off the printer. When you use this function, you will not be able to turn the printer on from the printer driver.

1. Select **Power Settings** from the pop-up menu on the [Canon IJ Printer Utility](#)
2. Execute power off

Click **Power Off**, and when the confirmation message appears, click **OK**.
The printer power switches off.



Auto Power

Auto Power allows you to set **Auto Power On** and **Auto Power Off**.

The **Auto Power On** function automatically turns on the printer when data is received.

The **Auto Power Off** function automatically turns off the printer when there are no operations from the printer driver or the printer for a specified period of time.

1. Select **Power Settings** from the pop-up menu on the [Canon IJ Printer Utility](#)
2. Check that the printer is on, and then click **Auto Power**

A dialog appears.

▶▶▶ Note

- If the printer is off or if communication between the printer and the computer is disabled, an error message may appear because the computer cannot collect the printer status.

3. If necessary, complete the following settings:

Auto Power On

Specifying **Enable** from the list will turn the printer on upon receipt of print data.

Auto Power Off

Specify the time from the list. When this time lapses without any operations from the printer driver or the printer, the printer is turned off automatically.

4. Apply the settings

The setting is enabled after this. When you want to disable this function, select **Disable** from the list according to the same procedure.

»» Important

- If you connect this printer to a network and use it, you can set **Auto Power Off** but the power will not be turned off automatically.

Reducing the Printer Noise

The silent function allows you to reduce the operating noise of this printer. Select when you wish to reduce the operating noise of the printer at night, etc.

Using this function may lower the print speed.

The procedure for using the quiet mode is as follows:

1. Select **Quiet Settings** from the pop-up menu on the [Canon IJ Printer Utility](#)

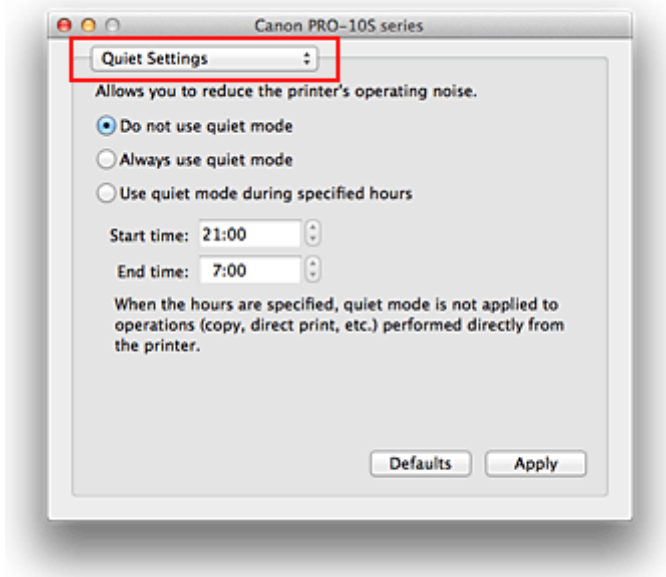

▶▶▶ Note

- If the computer is unable to communicate with the printer, a message may be displayed because the computer cannot access the function information that was set on the printer. If this happens, click **Cancel** to display the most recent settings specified on your computer.

2. Set the quiet mode

If necessary, specify one of the following items:

Do not use quiet mode

Select this option when you wish to use the printer with volume of normal operating noise.

Always use quiet mode

Select this option when you wish to reduce the operating noise of the printer.

Use quiet mode during specified hours

Select this option when you wish to reduce the operating noise of the printer during a specified period of time.

Set the **Start time** and the **End time** of the quiet mode you wish to be activated. If both are set to the same time, the quiet mode will not function.

▶▶▶ Important

- If you specify a time for **Use quiet mode during specified hours**, quiet mode is not applied to operations (direct print, etc.) performed directly from the printer.

3. Apply the settings

Make sure that the printer is on and click **Apply**.
Click **OK** when the confirmation message appears.

The settings are enabled hereafter.

Note

- The effects of the quiet mode may be less depending on the paper source and the print quality settings.

Changing the Printer Operation Mode

If necessary, switch between various modes of printer operation.

The procedure for configuring **Custom Settings** is as follows:

1. Make sure that the printer is on, and then select **Custom Settings** from the pop-up menu on the [Canon IJ Printer Utility](#)

▶▶▶ Note

- If the computer is unable to communicate with the printer, a message may be displayed because the computer cannot access the function information that was set on the printer. If this happens, click **Cancel** to display the most recent settings specified on your computer.

2. If necessary, complete the following settings:

Ink Drying Wait Time

You can set the length of the printer rest time until printing of the next page begins. Moving the slider to the right increases the pause time, and moving the slider to the left decreases the time. If the paper gets stained because the next page is ejected before the ink on the printed page dries, increase the ink drying wait time. Reducing the ink drying wait time speeds up printing.

Detects a printable disc in the disc tray

Detects whether a printable disc is loaded on the disc tray during disc label printing and displays a message if a disc is not loaded.

Check this check box to print with detecting whether a printable disc is loaded.

Uncheck this check box to print without detecting whether a printable disc is loaded.

▶▶▶ Important

- If you leave this check box unchecked, the printer may print to the disc tray even if a printable disc is not loaded on the disc tray. Therefore, you should check this check box under normal circumstances.
- If you load a printable disc that has already been printed onto the disc tray, the printer may detect that no printable disc is loaded on the disc tray. In this case, uncheck this check box.

Prevent paper abrasion

The printer can increase the gap between the print head and the paper during high-density printing to prevent paper abrasion.

Check this check box to prevent paper abrasion.

Detect paper width

Detects the width of paper loaded in the printer when printing.

When the paper width detected by the printer is narrower than the width of the paper specified in **Paper Size** on the Print dialog, a message is displayed and printing is stopped.

Check this check box to detect the paper width.

▶▶▶ Important

- When you use a custom page size, correctly set the size of the paper loaded in the printer in the **Custom Paper Sizes** dialog. If an error message is displayed even though paper of the same size that was specified is loaded, uncheck the **Detect paper width** check box.

Align heads manually

Usually, the **Print Head Alignment** function of **Test Print** on the pop-up menu in the Canon IJ Printer Utility is set to automatic head alignment, but you can change it to manual head alignment. If the printing results of automatic print head alignment are not satisfactory, [perform manual head alignment](#).

Check this check box to perform the manual head alignment. Uncheck this check box to perform the automatic head alignment.

Execute ink quality maintenance automatically

This function mixes the ink at fixed intervals to keep the ink density even.

To execute ink quality maintenance automatically, check this check box.

Important

- You should normally check this check box when using the printer.
When you disable this function, select **Test Print** from the pop-up menu of the Canon IJ Printer Utility and execute **Ink Quality Maintenance** at regular intervals.

3. Apply the settings

Click **Apply** and when the confirmation message appears, click **OK**.

The printer operates with the modified settings hereafter.

Initializing the Printer Settings

You can initialize the printer settings.

▶▶ Important

- When using the printer over LAN, note that initialization erases all network settings on the printer, and printing operation from a computer over network becomes impossible. To use the printer over network, perform setup according to the instructions on our website.

Follow the procedure below to initialize the printer settings.

1. [Make sure that the printer is turned on.](#)
2. Press and hold the **RESUME/CANCEL** button then release the button when the **POWER** lamp flashes 15 times.

All the printer settings are initialized. The administrator password specified by IJ Network Tool returns to the default setting.

After initializing the printer, perform setup again as necessary.

▶▶ Note

- You cannot initialize the current position of the print head.

Disabling the LAN Function of the Printer

Follow the procedure below to disable LAN.

1. [Make sure that the printer is turned on.](#)
2. Press and hold the **RESUME/CANCEL** button then release the button when the **POWER** lamp flashes 12 times.

The **Wi-Fi** lamp goes off if you disable the wireless LAN function.

Note

- When you enable the wireless LAN, press and hold the **RESUME/CANCEL** button, then release the button when the **POWER** lamp flashes 10 times.

When you enable the wired LAN, press and hold the **RESUME/CANCEL** button, then release the button when the **POWER** lamp flashes 11 times.

Information about Network Connection

- ▶ [Useful Information about Network Connection](#)

Useful Information about Network Connection

- ▶ **Default Values Set at Factory (Network)**
- ▶ **Connecting the Printer to the Computer Using a USB Cable**
- ▶ **When Detecting the Printers Have the Same Name**
- ▶ **Connecting to Other Computer with LAN/Changing the Connection Method from USB to LAN**
- ▶ **Printing Out Network Setting Information**

Default Values Set at Factory (Network)

Item	The default
Change wireless/wired LAN	Enable wireless LAN
SSID	BJNPSETUP
Communication mode	Infrastructure
Wireless LAN security	Disable
IPv4 IP address	Auto setup
IPv6 IP address	Auto setup
Set printer name *	XXXXXXXXXXXX
TCP/IP settings	IPv4 & IPv6
Enable/disable IPv6	Enable
Enable/disable WSD (WSD settings)	Enable
Timeout setting (WSD settings)	1 minute
Enable/disable Bonjour (Bonjour settings)	Enable
Service name (Bonjour settings)	Canon PRO-10S series
LPR protocol setting	Enable
Wireless LAN DRX	Enable
Wired LAN DRX	Enable

(* The default value in this item varies by the printer.)

Connecting the Printer to the Computer Using a USB Cable

Connect the printer and the computer using a USB cable as the illustration below. The USB port is located on the rear of the printer.

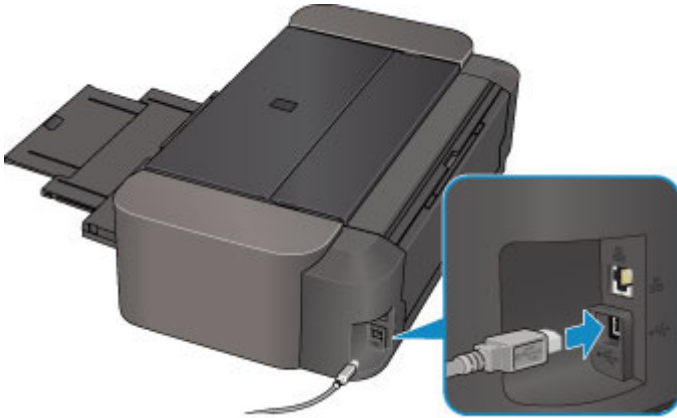

When Detecting the Printers Have the Same Name

When the printer is detected, you may see multiple printers of the same name on the detection result screen. The printer names on the screen are displayed with the MAC address added at the end of the names or displayed as the printer name specified by Bonjour.

Select a printer with checking the MAC address, the printer name specified by Bonjour, or the serial number set to the printer against that on the detection result screen.

▶▶ Note

- A serial number may not be displayed on the detection result screen.

To check the MAC address of the printer, print out the network setting information.

■ [Printing Out Network Setting Information](#)

Connecting to Other Computer with LAN/Changing the Connection Method from USB to LAN

To add the computer connecting the printer with LAN or to change the connection method between the printer and the computer from USB to LAN, perform setup according to the instructions on our website.

Connecting to Other Computer with LAN

To add the computer connecting the printer with LAN, perform setup according to the instructions on our website.

Changing the Connection Method from USB to LAN

To change the connection method to LAN while you are using the printer with USB connection, perform setup again according to the instructions on our website and select **Change Connection Method**.

Printing Out Network Setting Information

You can print out the current network settings of the printer.

▶▶▶ Important

- This print out contains valuable information about your computer. Handle it with care.

1. [Make sure that the printer is turned on.](#)
2. [Load a sheet of A4 or Letter-sized plain paper.](#)
3. Press and hold the **RESUME/CANCEL** button, then release the button when the **POWER** lamp flashes 6 times.

The printer starts printing the network setting information.

The following information on the printer's network setting is printed out.

Item	Explanations of the item	Setting
Wireless LAN	Wireless LAN	Enable/Disable
Connection	Connection status	Active/Inactive
MAC Address	MAC Address	XX:XX:XX:XX:XX:XX
SSID	SSID	SSID of the wireless LAN
Communication Mode	Communication Mode	Infrastructure
Channel *1	Channel	XX (1 to 13)
Encryption	Method of the Encryption	none/WEP/TKIP/AES
WEP Key Length	WEP Key Length	Inactive/128/64
Authentication	Method of the Authentication	none/auto/open/shared/WPA-PSK/WPA2-PSK
Signal Strength	Signal Strength	0 to 100 [%]
TCP/IP Version	TCP/IP Version	IPv4 & IPv6/IPv4
IPv4 IP Address	Selected IP Address (IPv4)	XXX.XXX.XXX.XXX
IPv4 Default Gateway	Default Gateway (IPv4)	XXX.XXX.XXX.XXX
Subnet Mask	Subnet Mask	XXX.XXX.XXX.XXX
IPv6 IP Address *2	Selected IP Address (IPv6)	XXXX:XXXX:XXXX:XXXX XXXX:XXXX:XXXX:XXXX
IPv6 Default Gateway *2	Default Gateway (IPv6)	XXXX:XXXX:XXXX:XXXX XXXX:XXXX:XXXX:XXXX
Subnet Prefix Length *2	Subnet Prefix Length	XXX
IPsec *3	IPsec setting	Active

Security Protocol *3	Method of the Security Protocol	ESP/ESP & AH/AH
WPS PIN CODE	WPS PIN code	XXXXXXXX
Wireless LAN DRX	Discontinuous reception (wireless LAN)	Enable/Disable
Wired LAN	Wired LAN	Enable/Disable
Connection	Status of the Wired LAN	Active/Inactive
MAC Address	MAC Address	XX:XX:XX:XX:XX:XX
TCP/IP Version	TCP/IP Version	IPv4 & IPv6/IPv4
IPv4 IP Address	Selected IP Address (IPv4)	XXX.XXX.XXX.XXX
IPv4 Default Gateway	Default Gateway (IPv4)	XXX.XXX.XXX.XXX
Subnet Mask	Subnet Mask	XXX.XXX.XXX.XXX
IPv6 IP Address *2	Selected IP Address (IPv6)	XXXX:XXXX:XXXX:XXXX XXXX:XXXX:XXXX:XXXX
IPv6 Default Gateway *2	Default Gateway (IPv6)	XXXX:XXXX:XXXX:XXXX XXXX:XXXX:XXXX:XXXX
Subnet Prefix Length *2	Subnet Prefix Length	XXX
IPsec *3	IPsec setting	Active
Security Protocol *3	Method of the Security Protocol	ESP/ESP & AH/AH
Wired LAN DRX	Discontinuous reception (wired LAN)	Enable/Disable
Other Settings	Other settings	-
Printer Name	Printer name	Printer name (Up to 15 alphanumeric characters)
WSD	WSD setting	Enable/Disable
WSD Timeout	Timeout	1/5/10/15/20 [min]
LPR Protocol	LPR protocol setting	Enable/Disable
Bonjour	Bonjour setting	Enable/Disable
Bonjour Service Name	Bonjour service name	Bonjour service name (Up to 52 alphanumeric characters)
DNS Server	Getting DNS Server automatically	Auto/Manual
Primary Server	Primary server address	XXX.XXX.XXX.XXX
Secondary Server	Secondary server address	XXX.XXX.XXX.XXX
Proxy Server	Proxy Server setting	Enable/Disable

Proxy Port	Specifying Proxy Port	1 to 65535
Proxy Address	Proxy Address	XXXXXXXXXXXXXXXXXXXXXX

("XX" represents alphanumeric characters.)

*1 Depending on the country or region of purchase, one of the channels from 1 to 11 is printed.

*2 Only when IPv6 is enabled, the status of the network is printed.

*3 Only when IPv6 and the IPsec setting are enabled, the status of the network is printed.

About Network Communication

- ▶ **Changing and Confirming Network Settings**
- ▶ **Appendix for Network Communication**

Changing and Confirming Network Settings

- ▶ **IJ Network Tool**
- ▶ **Canon IJ Network Tool Screen**
- ▶ **Canon IJ Network Tool Menus**
- ▶ **Changing the Settings in the Wireless LAN Sheet**
- ▶ **Changing the WEP Detailed Settings**
- ▶ **Changing the WPA/WPA2 Detailed Settings**
- ▶ **Changing the Settings in the Wired LAN Sheet**
- ▶ **Changing the Settings in the Admin Password Sheet**
- ▶ **Monitoring Wireless Network Status**
- ▶ **Initializing the Network Settings of the Machine**
- ▶ **Viewing the Modified Settings**

IJ Network Tool

IJ Network Tool is a utility that enables you to display and modify the machine network settings. It is installed when the machine is set up.

▶▶▶ Important

- To use the machine over LAN, make sure you have the equipment necessary for the connection type, such as a wireless router or a LAN cable.
- Do not start up IJ Network Tool while printing.
- Do not print when IJ Network Tool is running.
- If the firewall function of your security software is turned on, a message may appear warning that Canon software is attempting to access the network. If the warning message appears, set the security software to always allow access.

Starting up IJ Network Tool

1. Select **Applications** from the **Go** menu of Finder, double-click **Canon Utilities > IJ Network Tool**, and double-click the **Canon IJ Network Tool** icon.

Depending on the printer you are using, an administrator password is already specified for the printer at the time of purchase. When you change the network settings, authentication by the administrator password is required.

For details:

■ [About the Administrator Password](#)

For improving security, we recommend to change the administrator password.

■ [Changing the Settings in the Admin Password Sheet](#)

Canon IJ Network Tool Screen

This section describes the items displayed on the **Canon IJ Network Tool** screen.

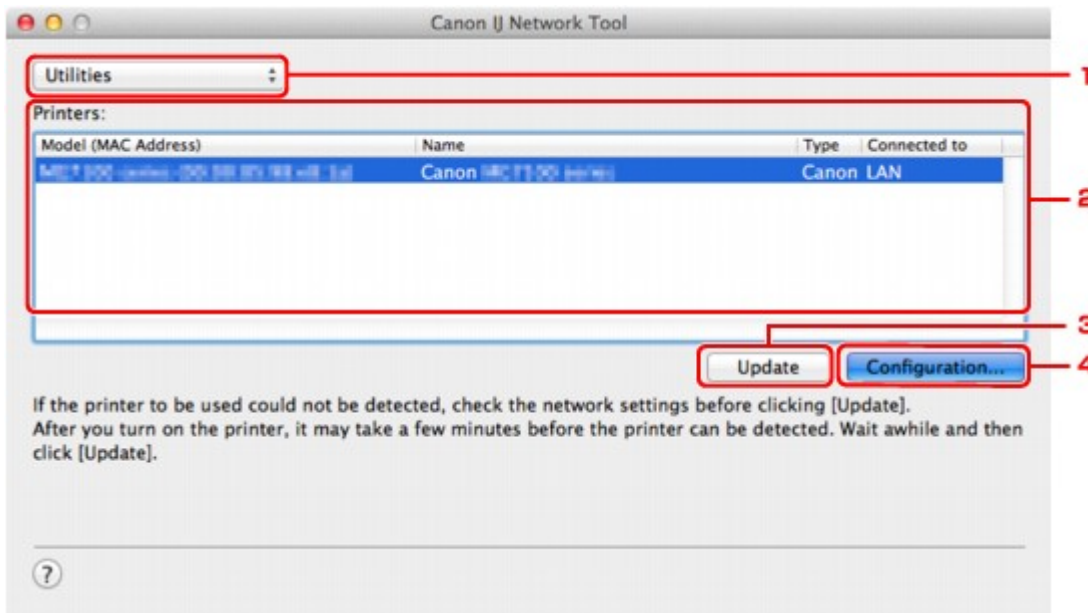

1. Utilities

Modifies the settings of the machine.

Select to change the network name (SSID) settings.

Setup

Sets up the machine.

If you setup the machine from scratch, connect your computer and the machine with a USB cable.

2. Printers:

Printer name, type, and connection destination are displayed.

The selected printer can be set up or be modified.

3. Update

Performs printer detection again. Click this button if the target printer is not displayed.

►►► Important

- To change the printer's network settings using IJ Network Tool, it must be connected via a LAN.
- If the printer on a network is not detected, make sure that the printer is turned on, then click **Update**. It may take several minutes to detect printers. If the printer is not yet detected, connect the machine and the computer with a USB cable, then click **Update**.
- If the printer is being used from another computer, a screen is displayed informing you of this condition.

►►► Note

- This item has the same function as **Refresh** in the **View** menu.

4. **Configuration...**

Enabled when **Utilities** is selected. Click to display the **Configuration** screen to configure settings of the selected printer.

Note

- This item has the same function as **Configuration...** in the **Settings** menu.

Canon IJ Network Tool Menus

This section describes the menus in **Canon IJ Network Tool**.



1. Canon IJ Network Tool menu

About Canon IJ Network Tool

Displays the version of this application.

Quit Canon IJ Network Tool

Exits IJ Network Tool.

2. View menu

Status

Displays the **Status** screen to confirm the printer connection status and wireless communication status.

In the access point mode, this item is grayed out and you cannot confirm the printer connection status.

Refresh

Updates and displays the contents of **Printers**: to the latest information.

»» Important

- To change the printer's network settings using IJ Network Tool, it must be connected via a LAN.
- If the printer on a network is not detected, make sure that the printer is turned on, then select **Refresh**. It may take several minutes to detect printers. If the printer is not yet detected, connect the machine and the computer with a USB cable, then select **Refresh**.
- If the printer is being used from another computer, a screen is displayed informing you of this condition.

»» Note

- This item has the same function as **Update** in the **Canon IJ Network Tool** screen.

Network Information

Displays the **Network Information** screen to confirm the network settings of the printer.

3. Settings menu

Configuration...

Displays the **Configuration** screen to configure settings of the selected printer.

»» Note

- This item has the same function as **Configuration...** in the **Canon IJ Network Tool** screen.

Maintenance...

Displays the **Maintenance** screen to return the network settings of the printer to factory default.

Set up printer's access point mode...

You can change the access point mode settings. Perform settings following the message on the screen.

If you change the **Encryption Method:** setting and the **Password:** setting, on the **Set up printer's access point mode** screen, the changed settings are applied to the printer settings.

▶▶▶ Note

- You can use this function only when you are using a computer compatible with the wireless LAN.

4. Help menu

Instructions

Displays this guide.

Changing the Settings in the Wireless LAN Sheet

To change the wireless network settings of the printer, connect the printer and the computer with a USB cable temporarily. If you modify the wireless network settings of the computer over wireless connection without USB connection, your computer may not be able to communicate with the machine after modifying the settings.

▶▶▶ Note

- This screen is not available depending on the printer you are using.
- Enable the wireless LAN setting of the printer to change the settings in the **Wireless LAN** sheet.

1. [Start up IJ Network Tool.](#)

2. Select the printer in **Printers:**.

When the printer is connected to the computer with a USB cable temporarily, select the printer with **USB** appearing in the **Connected to** column.

3. Click the **Configuration...** button.

4. Click the **Wireless LAN** button.

5. Change the settings or confirm.

Click **OK** after changing configuration. A screen is displayed asking you for confirmation before the settings are sent to the printer. If you click **OK**, the settings are sent to the printer and the **Transmitted Settings** screen is displayed.



1. Network Type:

Displays the wireless LAN mode currently selected.

AirPort Network (Infra)

Connects the printer to the wireless LAN with a wireless router.

Access point mode

Connects external wireless communication devices (e.g. computers, smartphones, or tablets) to the printer using it as an access point (wireless router).

▶▶▶ Note

- When **Access point mode** is displayed on **Network Type:**, you cannot change the settings on the **Wireless LAN** sheet or the **Admin Password** sheet.
- You can perform setting from **Set up printer's access point mode...** on the **Settings** menu when you use the printer with the access point mode.

Depending on the printer you are using, you can change the settings using the operation panel.

2. Network (SSID):

The network name (SSID) of the wireless LAN currently used is displayed.

In the access point mode, the access point name (SSID) of the printer is displayed.

▶▶▶ Note

- Enter the same SSID that the wireless router is configured to use. The SSID is case-sensitive.

3. Search...

The **Wireless Routers** screen is displayed to select a wireless router to connect to.

■ [Wireless Routers Screen](#)

▶▶▶ Note

- When IJ Network Tool runs over a LAN, the button is grayed out and cannot be selected. Connect the printer and the computer with a USB cable temporarily to change the settings.

4. Encryption Method:

Select the encryption method used over the wireless LAN.

▶▶▶ Important

- If all encryption types of the wireless router, printer, or computer do not match, the printer cannot communicate with the computer. If the printer cannot communicate with the computer after the encryption type of the printer was switched, make sure that encryption types for the computer and the wireless router match that set to the printer.
- If you connect to a network that is not protected with security measures, there is a risk of disclosing data such as your personal information to a third party.

Do Not Use

Select to disable encryption.

Use Password (WEP)

Transmission is encrypted using a WEP key you specified.

If a network password (WEP) has not been set, the **WEP Details** screen is displayed automatically. To change WEP settings set before, click **Configuration...** to display the screen.

■ [Changing the WEP Detailed Settings](#)

Use WPA/WPA2

Transmission is encrypted using a network key you specified.

The security has been strengthened more than WEP.

If a network key has not been set, the **Authentication Type Confirmation** screen is displayed automatically. To change network key settings before, click **Configuration...** to display the **WPA/WPA2 Details** screen.

■ [Changing the WPA/WPA2 Detailed Settings](#)

5. Configuration...

The detailed settings screen is displayed. The network password (WEP) or the WPA/WPA2 key selected in **Encryption Method**: can be confirmed and changed.

For details on WEP setting:

■ [Changing the WEP Detailed Settings](#)

For details on WPA/WPA2 setting:

■ [Changing the WPA/WPA2 Detailed Settings](#)

6. TCP/IP Setting:

Sets the IP address of the printer to be used over the LAN. Specify a value appropriate for your network environment.

Get IP address automatically

Select this option to use an IP address automatically assigned by a DHCP server. DHCP server functionality must be enabled on your wireless router.

Use following IP address

Select this option if no DHCP server functionality is available in your setup where you use the printer, or you want to use a particular IP address or a fixed IP address.

• Wireless Routers Screen

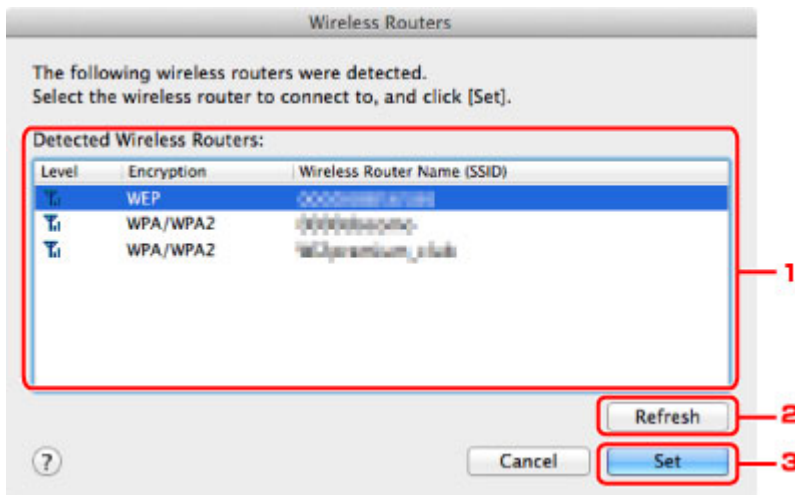

1. Detected Wireless Routers:

The signal strength from the wireless router, encryption type, name of wireless router, and the radio channel can be confirmed.

▶▶▶ Important

- If you connect to a network that is not protected with security measures, there is a risk of disclosing data such as your personal information to a third party.

»» Note

- Signal strength is displayed as follows.

 : Good

 : Fair

 : Poor

- Type of encryption is displayed as follows.

Blank: No encryption

WEP: WEP is set

WPA/WPA2: WPA/WPA2 is set

2. Refresh

Click to update the list of wireless routers when your target wireless router is not detected.

If the target wireless router is set to a closed network (the stealth mode), click **Cancel** to return to the previous screen and enter the network name (SSID) in **Network (SSID)**.

»» Note

- Make sure that the wireless router is turned on.

3. Set

Click to set the network name (SSID) in **Network (SSID)**: on the **Wireless LAN** sheet.

»» Note

- The **WPA/WPA2 Details** screen or the **WEP Details** screen appears if the selected wireless router is encrypted. In this case, configure the details to use the same encryption settings set to the wireless router.
- Wireless routers that cannot be used by this machine (including those configured to use different encryption methods) are displayed grayed out and cannot be configured.

Changing the WEP Detailed Settings

»» Note

- This screen is not available depending on the printer you are using.

To change the wireless network settings of the printer, connect the printer and the computer with a USB cable temporarily. If you modify the wireless network settings of the computer over wireless connection without USB connection, your computer may not be able to communicate with the machine after modifying the settings.

1. [Start up IJ Network Tool.](#)

2. Select the printer in **Printers:**.

When the printer is connected to the computer with a USB cable temporarily, select the printer with **USB** appearing in the **Connected to** column.

3. Click the **Configuration...** button.

4. Click the **Wireless LAN** button.

5. Select **Use Password (WEP)** in **Encryption Method:** and click **Configuration....**

The **WEP Details** screen is displayed.

6. Change the settings or confirm.

When changing the password (WEP key), the same change must be made to the password (WEP key) of the wireless router.

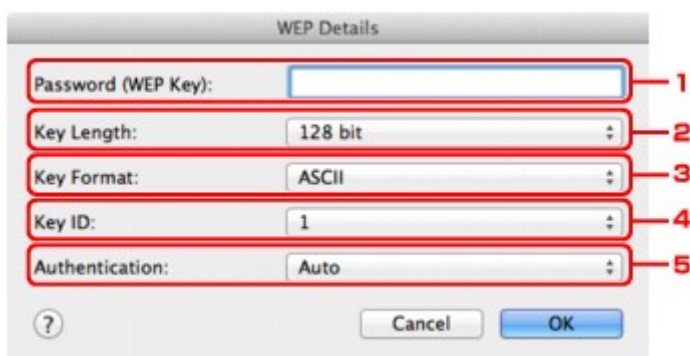

1. **Password (WEP Key):**

Enter the same key as the one set to the wireless router.

The number of characters and character type that can be entered differ depending on the combination of the key length and key format.

		Key Length	
		64 bit	128 bit
Key Format	ASCII	5 characters	13 characters
	Hexadecimal (Hex)	10 digits	26 digits

2. **Key Length:**

Select either **64 bit** or **128 bit**.

3. **Key Format:**

Select either **ASCII** or **Hex**.

4. **Key ID:**

Select the Key ID (index) set to the wireless router.

»» Note

- When the printer is connected to an AirPort Base Station via a LAN:

When the printer is connected to an AirPort Base Station via a LAN, confirm the settings in **Wireless Security** of **AirPort Utility**.

- Select **64 bit** if **WEP 40 bit** is selected for the key length in the AirPort Base Station.
- Select **1** for **Key ID**. Otherwise your computer will not be able to communicate with the printer via the wireless router.

5. **Authentication:**

Select the authentication method to authenticate the printer's access to the wireless router.

Normally, select **Auto**. If you want to specify the method manually, select **Open System** or **Shared Key** according to the setting of the wireless router.

7. Click **OK**.

»» Important

- If the printer cannot communicate with the computer after the encryption type of the printer was switched, make sure that encryption types for the computer and the wireless router match that set to the printer.

Changing the WPA/WPA2 Detailed Settings

»» Note

- This screen is not available depending on the printer you are using.

To change the wireless network settings of the printer, connect the printer and the computer with a USB cable temporarily. If you modify the wireless network settings of the computer over wireless connection without USB connection, your computer may not be able to communicate with the machine after modifying the settings.

The example screenshots in this section refer to the WPA detailed settings.

1. [Start up IJ Network Tool.](#)

2. Select the printer in **Printers:**.

When the printer is connected to the computer with a USB cable temporarily, select the printer with **USB** appearing in the **Connected to** column.

3. Click the **Configuration...** button.

4. Click the **Wireless LAN** button.

5. Select **Use WPA/WPA2** in **Encryption Method:** and click **Configuration...**

6. Enter the passphrase, then click **OK**.

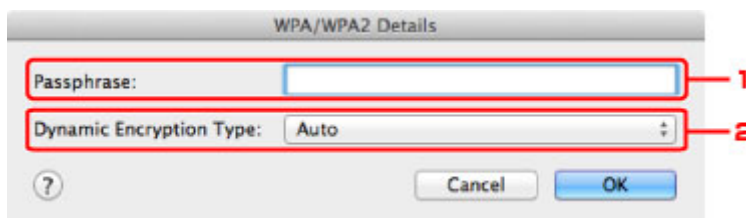

1. **Passphrase:**

Enter the passphrase set to the wireless router. The passphrase should be a string of 8 to 63 alphanumeric characters or a 64-digit hexadecimal value.

If you do not know the wireless router passphrase, refer to the instruction manual provided with the wireless router or contact its manufacturer.

2. **Dynamic Encryption Type:**

The dynamic encryption method is selected from either TKIP (basic encryption) or AES (secure encryption) automatically.

»» Important

- If **Auto** is not displayed on **Dynamic Encryption Type:**, select either **TKIP(Basic Encryption)** or **AES(Secure Encryption)**.
- If the printer cannot communicate with the computer after the encryption type of the printer was switched, make sure that encryption types for the computer and the wireless router match that set to the printer.

»» Note

- This machine supports WPA/WPA2-PSK (WPA/WPA2-Personal) and WPA2-PSK (WPA2-Personal).

Changing the Settings in the Wired LAN Sheet

▶▶▶ Note

- This screen is not available depending on the printer you are using.
- Enable the wired LAN setting of the printer to change the settings in the **Wired LAN** sheet.

1. [Start up IJ Network Tool.](#)
2. Select the printer in **Printers:**.
3. Click the **Configuration...** button.
4. Click the **Wired LAN** button.
5. Change the settings or confirm.

Click **OK** after changing configuration. A screen is displayed asking you for confirmation before the settings are sent to the printer. If you click **OK**, the settings are sent to the printer and the **Transmitted Settings** screen is displayed.

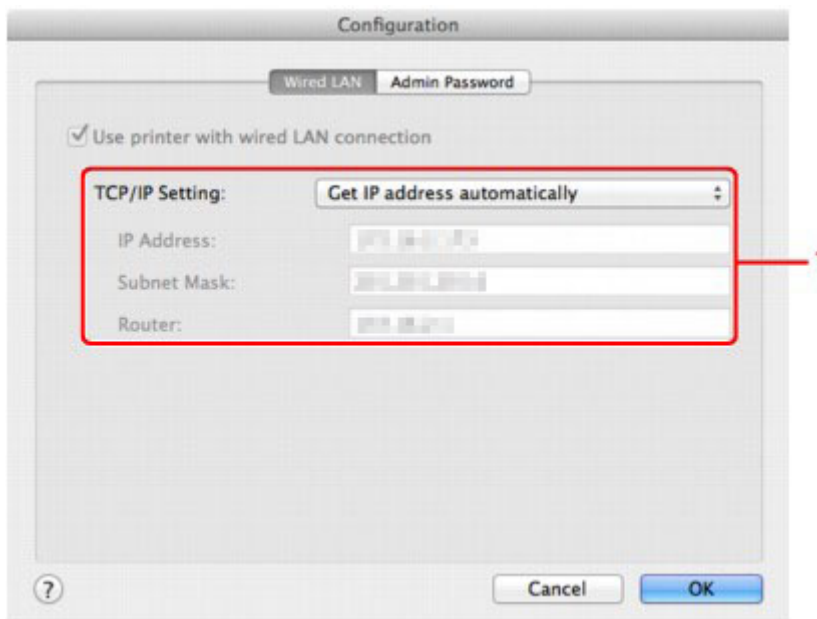

1. TCP/IP Setting:

Sets the IP address of the printer to be used over the LAN. Specify a value appropriate for your network environment.

Get IP address automatically

Select this option to use an IP address automatically assigned by a DHCP server. DHCP server functionality must be enabled on your router.

Use following IP address

Select this option if no DHCP server functionality is available in your setup where you use the printer, or you want to use a particular IP address or a fixed IP address.

Changing the Settings in the Admin Password Sheet

»» Note

- You cannot change the settings when using the access point mode.

1. [Start up IJ Network Tool.](#)
2. Select the printer in **Printers:**.
3. Click the **Configuration...** button.
4. Click the **Admin Password** button.
The **Admin Password** sheet is displayed.
5. Change the settings or confirm.

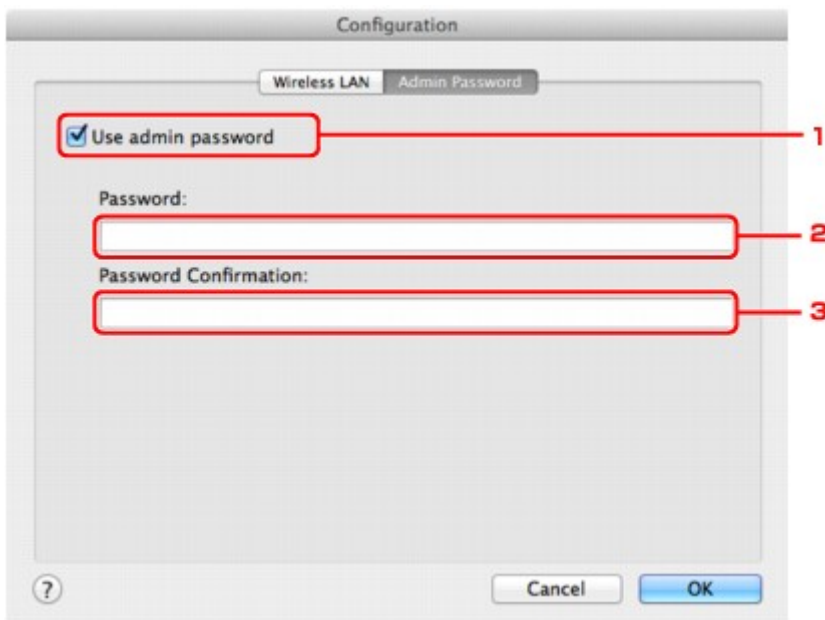

1. Use admin password

Sets an administrator password with privileges to set up and change detailed options. To use this feature, select this check box and enter a password.

»» Important

- The password should consist of alphanumeric characters and be no longer than 32 characters. The password is case-sensitive. Do not forget the password you set.

2. Password:

Enter the password to set.

3. Password Confirmation:

Enter the password again for confirmation.

6. Click **OK**.

A screen is displayed asking you for confirmation before the settings are sent to the printer. If you click **OK**, the settings are sent to the printer and the **Transmitted Settings** screen is displayed.

Enter Password Screen

The following screen is displayed if an administrator password is set to the printer.



- **Admin Password**

Enter the administrator password that was set. For security purposes, your password is not displayed as you type it.

►► Important

- If you forget the administrator password you specified, initialize the printer to return the password to the default setting.

- **OK**

Click this item after you enter the administrator password.

- **Cancel**

This item returns you to list of detected printers. If you do not enter the correct administrator password, you cannot operate the printer.

Monitoring Wireless Network Status

►► Note

- This screen is not available depending on the printer you are using.
- When using the machine over the wired LAN, you cannot monitor network status.

1. [Start up IJ Network Tool.](#)
2. Select the printer in **Printers:**.
3. Select **Status** on the **View** menu.

The **Status** screen is displayed and you can check the printer status and connection performance.

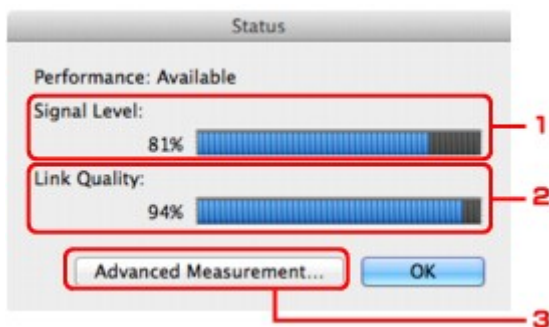

1. **Signal Level:**

Indicates the strength of the signal received by the printer, ranging from 0% to 100%.

2. **Link Quality:**

Indicates the signal quality excluding the noise while communicating, ranging from 0% to 100%.

►► Important

- If the indicated value is low, move your printer closer to the wireless network device.

3. **Advanced Measurement...**

Click to examine the connection performance between the printer and the wireless router. Follow the instructions on the screen to start measuring and display the status. Measurement takes a few minutes.

When  is displayed in **Connection performance between the printer and the wireless router:**, the printer can communicate with the wireless router. Otherwise, refer to displayed comments and Help for improving the status of communication link, and click **Remeasurement**.

- Check that the printer and the wireless router are located within the wireless connectivity range with no obstacles between them.

- Check if the distance between the printer and the wireless router is not too far.

If they are too far, move them closer together (within 164 ft. / 50 m).

- Check that there is no barrier or obstacle between the printer and the wireless router.

In general, connection performance decreases for communications through walls or between different floors. Adjust the locations to avoid such situations.

- Check that there are no sources of radio interference near the printer and the wireless router.

The wireless connection may use the same frequency band as microwave ovens and other sources of radio interference. Try to keep the printer and the wireless router away from such sources.

- Check if the radio channel of the wireless router is close to that of other wireless routers nearby.

If the radio channel of the wireless router is close to that of other wireless routers nearby, the connection performance may become unstable. Be sure to use a radio channel that does not interfere with other wireless routers.

- Check that the printer and the wireless router face each other.

Connection performance may depend on the orientations of the wireless devices. Replace the wireless router and the printer in another direction to achieve the best performance.

- Check whether other computers are not accessing the printer.

If  appears in the result of the measurement, check whether other computers are not accessing the printer.

If  still appears even if you have tried the above, finish the measurement, then restart the IJ Network Tool to start over the measurement.

Note

- If any messages appear on **Overall Network Performance:**, move the machine and wireless router as instructed on the screen to improve the performance.

Initializing the Network Settings of the Machine

»» Important

- Note that initialization erases all network settings on the machine, and printing or scanning operation from a computer over network becomes impossible. To use the machine over network, perform setup according to the instructions on our website.

1. [Start up IJ Network Tool.](#)
2. Select the printer in **Printers:**.
3. Select **Maintenance...** on the **Settings** menu.

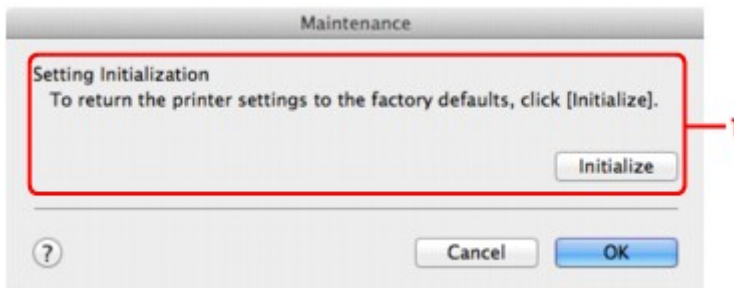

1. Setting Initialization

Initialize

Returns all the network settings of the printer to factory default.

4. Click **Initialize**.

The **Setting Initialization** screen is displayed.

Click **OK** to initialize the network settings of the printer. Do not turn off the printer during initialization.

Click **OK** when initialization is complete.

Performing initialization when connected over wireless LAN will break the connection, so perform setup according to the instructions on our website.

»» Note

- You can change the network settings of the printer using IJ Network Tool with USB connection after initializing the LAN settings. To change the network settings using Canon IJ Network Tool, enable wireless LAN in advance.

Viewing the Modified Settings

The **Confirmation** screen is displayed after you modified the printer settings on the **Configuration** screen. When you click **OK** on the **Confirmation** screen, the following screen is displayed for confirming the modified settings.

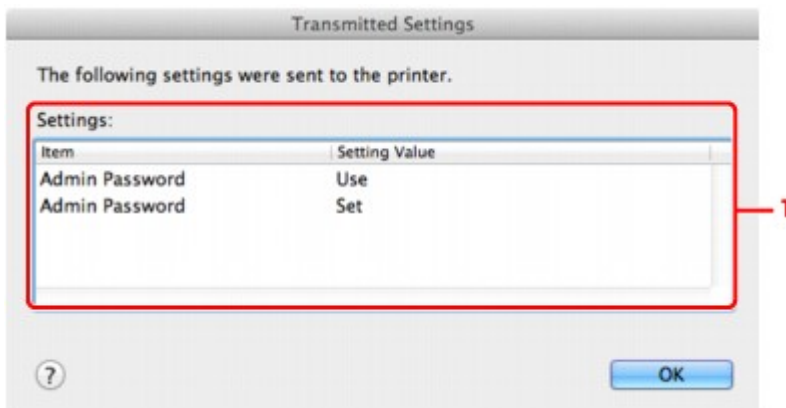

1. Settings:

A list of changes made in the **Configuration** screen is displayed.

Appendix for Network Communication

- ▶ **Using the Card Slot over a Network**
- ▶ **About Technical Terms**
- ▶ **Restrictions**

Using the Card Slot over a Network

»» Note

- This function is not available depending on the printer you are using. To confirm whether this function is available with your printer, refer to [List of Function for Each Model](#).

■ ■ [Mounting the Card Slot as the Network Drive](#)

■ ■ [Restrictions on Card Slot Use over a Network](#)

Mounting the Card Slot as the Network Drive

The card slot must be mounted to use it over a network.

To mount the card slot as the network drive, follow the procedure below.

1. Insert a memory card into the card slot of the machine.
2. Check the current printer name.
You can check the current printer name on the LCD of the printer.
3. On Finder, click the **Go** menu and **Connect to Server**.
4. Input "smb://xxxxxxxxxxx/canon_memory/", then click **Connect**.

For example, if the current printer name is "123ABC000000", then input "smb://123ABC000000/canon_memory/".

5. Make sure that the card slot is mounted.

When the card slot is mounted, the following icon appears on the desktop or in the **Computer** window on the **Go** menu of Finder.



»» Note

- The authentication screen may appear. If it appears, you do not need to input the password.
- If you cannot mount the card slot with the method above, input the IP address of the machine instead of the current printer name, and try again. For example, "smb://192.168.1.1/canon_memory/". If you mount the card slot with the IP address, you have to remount it whenever the machine's IP address changes.

Restrictions on Card Slot Use over a Network

- You cannot write data to a memory card in the card slot over a network. You can only read data from a memory card.

- The card slot can be shared by multiple computers, if the machine is connected to a network. Multiple computers can read files from a memory card in the card slot at the same time.
- If your computer joins a domain, the card slot may not be mounted as the network drive.
- If you use the memory card stored the large size files or many files, a large amount of card access may be generated. In this case, the operation in the memory card may be impossible or slow. Operate after the **Access** lamp of the machine is lit.

- When you access the network drive for the card slot over the network, file names consisting of eight or less lowercase letters (not including its extension) may be shown in uppercase.

For example, a file name such as "abcdefg.doc" will be "ABCDEFGG.DOC", while a name such as "AbcdeFG.doc" will appear the same.

The file is not actually renamed, but merely appears to be changed.

- Disable the function to write files to a memory card from a computer to read files from a memory card over a network.

About Technical Terms

In this section, technical terms used in the manual are explained.

[A](#)

[B](#)

[C](#)

[D](#)

[E](#)

[I](#)

[K](#)

[L](#)

[M](#)

[N](#)

[P](#)

[R](#)

[S](#)

[T](#)

[U](#)

[W](#)

A

- **Access point mode**

The machine is used as a wireless router to connect external wireless communication devices (e.g. computers, smartphones, or tablets) in an environment where no wireless router is available. You can connect up to 5 devices to the machine using the access point mode.

- **Ad-hoc**

Client computer and machine setting where wireless communication occurs on a peer-to-peer basis, i.e., all clients in with the same SSID/network name communicate directly with each other. No wireless router is required. This machine does not support ad-hoc communication.

- **Admin Password**

Administrator password in IJ Network Tool to restrict access to network users. It must be entered to access the printer and change printer settings.

- **AES**

An encryption method. It is optional for WPA/WPA2. Strong cryptographic algorithm adopted within U.S. government organizations for information processing.

- **AirPort Network (Infra)**

Client computer and machine setup where all wireless communications pass through a wireless router.

- **Authentication Method**

The method that a wireless router uses to authenticate a printer through a wireless LAN. The methods are agreeable each other.

When using WEP as an encryption method, the authentication method is able to fix to **Open System** or **Shared Key**.

For WPA/WPA2, authentication method is PSK.

- **Auto**

The printer automatically changes its authentication method to match the wireless router.

- **Open System**

In this authentication method, the communication partner is authenticated without using WEP key even if **Use Password (WEP)** is selected.

- **Shared Key**

In this authentication method, the communication partner is authenticated using the WEP key that was set for encryption.

B

- **Bonjour**

A service built into Mac OS X operating system to detect the connectable devices on a network automatically.

C

- **Channel**

Frequency channel for wireless communication. In the infrastructure mode, the channel is automatically adjusted to match that set to the wireless router. This machine supports channels 1 to 13. (Channels 12 and 13 are not supported depending on the country or region of purchase.) Note that the number of channels that can be used for your wireless LAN varies depending on the region or country.

D

- **DHCP server functionality**

The router assigns an IP address automatically whenever the printer or the personal computer on a network starts up.

- **DNS server**

A server that converts device names into IP addresses. When specifying IP addresses manually, specify the addresses of both a primary and a secondary server.

F

- **Firewall**

It is a system that prevents an unlawful computer access in the network. To prevent, you can use the firewall function of a broadband router, the security software installed in the computer, or operation system for computer.

I

- **IEEE 802.11b**

International standard for wireless LAN using the 2.4 GHz frequency range with a throughput of up to 11 Mbps.

- **IEEE 802.11g**

International standard for wireless LAN using the 2.4 GHz frequency range with a throughput of up to 54 Mbps. Compatible with 802.11b.

- **IEEE 802.11n**

International standard for wireless LAN using the 2.4 GHz and 5 GHz frequency ranges. Even when using two or more antennas simultaneously or obtaining a bigger transfer rate than before by using multiple communication channels at the same time, the transmission speed may be influenced by the connected apparatus.

At the maximum transfer rate of 600 Mbps, it is possible to communicate with multiple computer terminals within a dozen or so metre radius.

Compatible with 802.11b and 802.11g.

- **IP Address**

A unique number with four parts separated by dots. Every network device that is connected to the Internet has an IP address. Example: 192.168.0.1

An IP address is usually assigned by a wireless router or a DHCP server of the router automatically.

- **IPv4/IPv6**

They are internet network-layer protocol used on the internet. IPv4 uses 32-bit addresses and IPv6 uses 128-bit addresses.

K

- **Key Format**

Select either **ASCII** or **Hex** as the Password (WEP) key format. The character that can be used for the WEP key differs depending on the selected key formats.

- ASCII

Specify with a 5 or 13-character string that can include alphanumeric and underscore "_" characters. It is case-sensitive.

- Hex

Specify a 10-digit or 26-digit string that can contain hexadecimal (0 to 9, A to F, and a to f).

- **Key Length**

Length of the WEP key. Select either 64 bits or 128 bits. Longer key length allows you to set a more complex WEP key.

L

- **Link Quality**

The status of the connection between the wireless router and the printer excluding noise (interference) is indicated with a value from 0 to 100%.

- **LPR**

A platform-independent printing protocol used in TCP/IP networks. It does not support bidirectional communication.

M

- **MAC Address (AirPort ID)**

Also known as the physical address. A unique and permanent hardware identifier that is assigned to network devices by its manufacturer. MAC addresses are 48 bits long and are written as a hexadecimal number separated by colons, i.e., 11:22:33:44:55:66.

N

- **Network (SSID)**

Unique label for wireless LAN. It is often represented such as a network name or a wireless router name.

SSID distinguishes one wireless LAN from another to prevent interference.

The printer and all clients on a wireless LAN must use the same SSID in order to communicate with each other. The SSID can be up to 32 characters long, and is made up of alphanumeric characters. The SSID may also be referred to by its network name.

P

- **Password (WEP)/Password (WEP Key)**

An encryption method employed by IEEE 802.11. Shared security key used to encrypt and decrypt data sent over wireless networks. This printer supports key length of 64 bits or 128 bits, key format of ASCII code or Hexadecimal, and key number of 1 to 4.

- **Performance**

Indicates the status on whether the printer can be used.

- **Proxy server**

A server that links a LAN-connected computer to the Internet. When using a proxy server, specify the address and the port number of the proxy server.

- **PSK**

An encryption method employed by WPA/WPA2.

R

- **Router**

A relay device to connect to another network.

S

- **Signal Level**

The strength of the signal received by the printer from the wireless router is indicated with a value from 0 to 100%.

- **SSID**

Unique label for wireless LAN. It is often represented such as a network name or a wireless router name.

SSID distinguishes one wireless LAN from another to prevent interference.

The printer and all clients on a wireless LAN must use the same SSID in order to communicate with each other. The SSID can be up to 32 characters long, and is made up of alphanumeric characters. The SSID may also be referred to by its network name.

- **Stealth**

In the stealth mode, a wireless router hides itself by not broadcasting its SSID. The client must specify the SSID set to the wireless router to detect it.

The stealth mode is called a "closed network".

- **Subnet Mask Address**

IP address has two components, the network address and the host address. Subnet Mask used to calculate the Subnet Mask address from the IP address. A Subnet Mask is usually assigned by a wireless router or a DHCP server of the router automatically.

Example:

IP Address: 192.168.127.123

Subnet Mask: 255.255.255.0

Subnet Mask Address: 192.168.127.0

T

- **TCP/IP**

Suite of communications protocols used to connect hosts on the Internet or the LAN. This protocol allows different terminals to communicate with each other.

- **TKIP**

An encryption protocol employed by WPA/WPA2.

U

- **USB**

Serial interface designed to enable you to "hot-swap" devices, i.e., by plugging and unplugging them without turning off the power.

W

- **WEP/WEP Key**

An encryption method employed by IEEE 802.11. Shared security key used to encrypt and decrypt data sent over wireless networks. This printer supports key length of 64 bits or 128 bits, key format of ASCII code or Hexadecimal, and key number of 1 to 4.

- **Wi-Fi**

International association that certifies interoperability of wireless LAN products based on the IEEE 802.11 specification.

This machine is a Wi-Fi authorized product.

- **Wireless LAN**

A network that, instead of being connected by physical wires, is connected by a wireless technology, such as Wi-Fi.

- **Wireless Router**

A wireless transceiver or base station that receives information from wireless clients/the machine and rebroadcasts it. Required in an infrastructure network.

- **WPA**

Security framework announced by the Wi-Fi Alliance in October 2002. The security has been strengthened more than WEP.

- Authentication

WPA defines the following authentication methods: WPA Personal that can be used without an authentication server, plus WPA Enterprise that do require an authentication server.

This machine supports WPA Personal.

- Passphrase

This encrypted key is used to perform WPA Personal authentication.

The passphrase should be a string of 8 to 63 alphanumeric characters or a 64-digit hexadecimal value.

- **WPA2**

Security framework released by the Wi-Fi Alliance in September 2004 as a later version of WPA. Provides a stronger encryption mechanism through Advanced Encryption Standard (AES).

- Authentication

WPA2 defines the following authentication methods: WPA2 Personal that can be used without an authentication server, plus WPA2 Enterprise that do require an authentication server.

This machine supports WPA2 Personal.

- Passphrase

This encrypted key is used to perform WPA2 Personal authentication.

The passphrase should be a string of 8 to 63 alphanumeric characters or a 64-digit hexadecimal value.

- **WPS (Wi-Fi Protected Setup)**

WPS is a standard for easy and secure establishment of a wireless network.

There are 2 primary methods used in the Wi-Fi Protected Setup:

PIN entry: a mandatory method of setup for all WPS certified devices

Push button configuration (PBC): an actual push button on the hardware or through a simulated push button in the software.

Restrictions

If you use a printer over the wireless LAN, the printer may recognize nearby wireless systems, you should set a network key (WEP or WPA/WPA2) to the wireless router to encrypt wireless transmission. Wireless communication with a product that does not comply with the Wi-Fi standard cannot be guaranteed.

Connecting with too many computers may affect the printer performance, such as printing speed.

Tips for Ensuring Optimal Printing Quality

- ▶ **Useful Information about Ink**
- ▶ **Key Points to Successful Printing**
- ▶ **Be Sure to Make Paper Settings after Loading Paper**
- ▶ **Canceling a Print Job**
- ▶ **Printer Handling Precautions**
- ▶ **Key to Enjoying Consistent Printing Quality**
- ▶ **Precautions for Safe Transport of the Printer**

Useful Information about Ink

How is ink used for various purposes other than printing?

Ink may be used for purposes other than printing.

When you use the Canon printer for the first time after you install the bundled ink tanks, the printer consumes a small amount of ink in the amount to enable printing by filling the nozzles of the Print Head with ink. For this reason, the number of sheets that can be printed with the first ink tanks is fewer than the succeeding ink tanks.

The printing costs described in the brochures or websites are based on the consumption data from not the first ink tank /ink cartridge but the succeeding ink tank /ink cartridge.

Ink is sometimes used to maintain the optimal printing quality.

To keep printer's performance, Canon printer performs cleaning automatically according to its condition. When the printer performs cleaning, a small amount of ink is consumed. In this case, all colors of ink may be consumed.

[Cleaning function]

The cleaning function helps the printer to suck air bubbles or ink itself from the nozzle and thus prevents print quality degradation or nozzle clogging.

Does black-and-white printing use color ink?

Black-and-white printing may use ink other than black ink depending on the type of printing paper or the settings of the printer driver. So, color ink is consumed even when printing in black-and-white.

The ink lamp indicates when ink is running low.

The ink lamp flashes to indicate that the ink is running low.

■ [Checking the Ink Status with the Ink Lamps](#)

▶▶▶ Note

- The printer uses pigment ink. Due to the nature of the pigment ink, the ink on the printed surface may be removed when being rubbed or scratched.

Key Points to Successful Printing

Check the printer status before printing!

- Is the print head OK?

If a print head nozzle is clogged, print will be faint and papers will be wasted. Print the nozzle check pattern to check the print head.

■ [Maintenance Procedure](#)

- Is the inside of the printer smeared with ink?

After printing large quantities of paper or performing borderless printing, the area where papers go through may get smeared with ink. Clean the inside of your printer with [Bottom Plate Cleaning](#).

Check how to load the paper correctly!

- Is the paper loaded in the correct orientation?

To load paper in the rear tray or manual feed tray, load paper WITH THE PRINT SIDE FACING YOU.

■ [Loading Paper](#)



A



B

A: rear tray

B: manual feed tray

- Is the paper loaded in the proper paper source?

Load paper either in the rear tray or in the manual feed tray, depending on the size or thickness of paper.



C



D

C: Load two or more sheets of paper at a time.

D: Load one sheet of large size paper, such as 14" x 17" (36 x 43 cm) paper, or thick paper at a time.

- Is the paper curled?

The curled paper causes paper jam. Flatten the curled paper, then reload it.

- "Load the paper after correcting its curl." in [Paper Is Smudged/Printed Surface Is Scratched](#)

Be Sure to Make Paper Settings after Loading Paper

If the media type setting is not the one for the loaded paper, printing results may not be satisfactory. After loading paper, be sure to select the appropriate media type setting for the loaded paper.

■ [Print Results Not Satisfactory](#)

There are various types of paper: paper with special coating on the surface for printing photos with optimal quality and paper suitable for documents.

Each media type has specific preset settings, such as how ink is used and sprayed, distance from nozzles, etc., so that you can print on that type with optimal image quality.

This allows you to print with the settings best suited for the loaded media type just by selecting that media type.

Canceling a Print Job

Never press the ON button!

If you press the **ON** button while printing is in progress, the print data sent from the computer queues in the printer and you may not be able to continue to print.

Press the **RESUME/CANCEL** button to cancel printing.

Printer Handling Precautions

Do not place any object on the top cover!

Do not place any object on the top cover. It will fall into the rear tray when the top cover is opened and cause the printer to malfunction. Also, place the printer where objects will not fall on it.

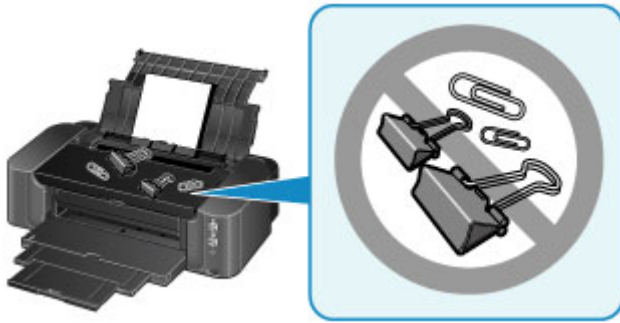

Key to Enjoying Consistent Printing Quality

The key to printing with the optimal printing quality is to prevent the print head from drying or clogging. Always observe the following rules for optimal printing quality.

►► Note

- Depending on the type of paper, ink may blur if you trace the printed area with a highlight pen or paint-stick, or bleed if water or sweat comes in contact with the printed area.

Never unplug the power cord until the power is turned off!

If you press the **ON** button to turn off the power, the printer caps the print head (nozzles) automatically to prevent from drying. If you unplug the power cord from the wall outlet before the **POWER** lamp is turned off, the print head will not be capped properly and this will cause drying or clogging.

When [unplugging the power cord](#), make sure that the **POWER** lamp is not lit.

Print periodically!

Just as the tip of a felt pen becomes dry and unusable if it has not been used for a long time, even if it is capped, the print head too, may become dried or clogged if the printer has not been used for a long time. We recommend you to use the printer at least once a month.

Ink is mixed at fixed intervals.

The printer is set to automatically mix the ink to maintain optimal printing quality. Therefore, printing on a regular basis helps keep the ink in good condition. If the printer is not used for an extended period of time, the printer will automatically mix the ink when the power is turned on.

However, if the function of automatic ink mixing is disabled or the colors on the printout become uneven, mix the ink manually.

- [Maintaining the Ink Quality](#)

Precautions for Safe Transport of the Printer

When relocating the printer, make sure of the following.

▶▶▶ Important

- Pack the printer in a sturdy box so that it is placed with its bottom facing down, using sufficient protective material to ensure safe transport.
- With the print head and ink tank left installed in the printer, press the **ON** button to turn off the power. This allows the printer to automatically cap the print head, thus preventing it from drying.
- After packing, do not tilt the box containing the printer or turn it on its side or upside down. Doing so may cause the ink to leak during transport and cause damage to the printer.
- When a shipping agent is handling transport of the printer, have its box marked "THIS SIDE UP" to keep the printer with its bottom facing down. Mark also with "FRAGILE" or "HANDLE WITH CARE".



1. Turn the printer off.
2. Confirm that the **POWER** lamp is off and [unplug the power cord](#).

▶▶▶ Important

- Do not unplug the printer while the **POWER** lamp is lit or flashing, as it may cause malfunction or damage to the printer, making the printer unable to print.

3. Retract the output tray extension, then close the paper output tray and the paper support gently.
4. Unplug the printer cable from the computer and from the printer, then unplug the power cord from the printer.
5. Use adhesive tape to secure all the covers on the printer to keep them from opening during transportation. Then pack the printer in the plastic bag.
6. Attach the protective material to the printer when packing the printer in the box.

▶▶▶ Important

- When setting up the printer, always carry it with two people.

Legal Limitations on Use of Your Product and Use of Images

It may be unlawful to print the following documents.

The list provided is non-exhaustive. When in doubt, check with a legal representative in your jurisdiction.

- Paper money
- Money orders
- Certificates of deposit
- Postage stamps (canceled or uncanceled)
- Identifying badges or insignias
- Selective service or draft papers
- Checks or drafts issued by governmental agencies
- Motor vehicle licenses and certificates of title
- Traveler's checks
- Food stamps
- Passports
- Immigration papers
- Internal revenue stamps (canceled or uncanceled)
- Bonds or other certificates of indebtedness
- Stock certificates
- Copyrighted works/works of art without permission of copyright owner

Specifications

General Specifications

Printing resolution (dpi)	4800* (horizontal) x 2400 (vertical) * Ink droplets can be placed with a pitch of 1/4800 inch at minimum.
Interface	<p>USB Port: Hi-Speed USB *1</p> <p>Direct Print Port: PictBridge</p> <p>LAN Port: Wired LAN: 100BASE-TX / 10BASE-T Wireless LAN: IEEE802.11n / IEEE802.11g / IEEE802.11b *2</p> <p>*1 A computer that complies with Hi-Speed USB standard is required. Since the Hi-Speed USB interface is fully upwardly compatible with USB 1.1, it can be used at USB 1.1.</p> <p>*2 Setup possible through WPS (Wi-Fi Protected Setup), WCN (Windows Connect Now) or Cableless setup.</p> <p>USB and LAN can be used at the same time. Wireless LAN and wired LAN cannot be used at the same time.</p>
Print width	<p>Manual Feed Tray: 13.7 inches/348.8 mm (for Borderless Printing: 14 inches/356 mm)</p> <p>Rear Tray: 12.7 inches/322.2 mm (for Borderless Printing: 13 inches/329 mm)</p>
Operating environment	<p>Temperature: 41 to 95 °F (5 to 35 °C)</p> <p>Humidity: 10 to 90 % RH (no condensation)</p> <p>* The performance of the printer may be reduced under certain temperature and humidity conditions.</p> <p>Recommended conditions:</p> <p>Temperature: 59 to 86 °F (15 to 30 °C)</p> <p>Humidity: 10 to 80 % RH (no condensation)</p> <p>* For the temperature and humidity conditions of papers such as photo paper, refer to the paper's packaging or the supplied instructions.</p>
Storage environment	<p>Temperature: 32 to 104 °F (0 to 40 °C)</p> <p>Humidity: 5 to 95 % RH (no condensation)</p>
Power supply	AC 100-240 V, 50/60 Hz
Power consumption	<p>Printing: Approx. 18 W *1</p> <p>Standby (minimum): Approx. 2.1 W *1*2</p> <p>OFF: Approx. 0.4 W</p> <p>*1 Wireless LAN is active.</p> <p>*2 The wait time for standby cannot be changed.</p>
External dimensions	<p>Approx. 27.2 (W) x 15.2 (D) x 8.5 (H) inches</p> <p>Approx. 689 (W) x 385 (D) x 215 (H) mm</p>

	* With the Paper Support and Paper Output Tray retracted.
Weight	Approx. 43.9 lb (Approx. 20.0 kg) * With the Print Head and ink tanks installed.
Print Head/Ink	Total 7680 nozzles (PM / PC / Y / M / R / PBK / C / CO / MBK / GY each 768 nozzles)

Network Specifications

Communication protocol	TCP/IP
Wired LAN	Supported Standards: IEEE802.3u (100BASE-TX) / IEEE802.3 (10BASE-T) Transfer speed: 10 M/100 Mbps (auto switching)
Wireless LAN	Supported Standards: IEEE802.11n / IEEE802.11g / IEEE802.11b Frequency bandwidth: 2.4 GHz Channel: 1-11 or 1-13 * Frequency bandwidth and available channels differ depending on country or region. Communication distance: Indoors 164 feet/50 m * Effective range varies depending on the installation environment and location. Security: WEP (64/128 bits) WPA-PSK (TKIP/AES) WPA2-PSK (TKIP/AES) Setup: WPS (Push button configuration/PIN code method) WCN (WCN-NET) Cableless setup Other Features: Administration password

Minimum System Requirements

Conform to the operating system's requirements when higher than those given here.

Windows

Operating System	Windows 8.1*, Windows 8 Windows 7, Windows 7 SP1 Windows Vista SP1, Windows Vista SP2 Windows XP SP3 32-bit only * Windows 8.1 includes Windows 8.1 Update.
Browser	Internet Explorer 8 or later
Hard Disk Space	3 GB Note: For bundled software installation.

	The necessary amount of hard disk space may be changed without notice.
Display	XGA 1024 x 768

Mac OS

Operating System	Mac OS X v10.7.5 or later
Browser	Safari 5 or later
Hard Disk Space	1.5 GB Note: For bundled software installation. The necessary amount of hard disk space may be changed without notice.
Display	XGA 1024 x 768

Other Supported OS

Some functions may not be available with each OS. Refer to the Canon web site for details on operation with iOS, Android, and Windows RT.

Mobile Printing Capability

Apple AirPrint
PIXMA Cloud Link

- An internet connection is required to use all the *Online Manual*.
- Windows: Operation can only be guaranteed on a computer with Windows 8.1, Windows 8, Windows 7, Windows Vista or Windows XP pre-installed.
- Windows: A CD-ROM Drive or internet connection is required during software installation.
- Windows: Internet Explorer 8, 9, 10 or 11 is required to install Easy-WebPrint EX.
- Windows: Some functions may not be available with Windows Media Center.
- Windows: .NET Framework 4 or 4.5 must be installed to use the Windows software.
- Windows: XPS Essentials Pack is required to print on Windows XP.
- Mac OS: Hard Disk must be formatted as Mac OS Extended (Journaled) or Mac OS Extended.
- Mac OS: For Mac OS, an internet connection is required during software installation.
- In an in-house network environment, the 5222 port must be open. Contact the network administrator for details.

Information in this guide is subject to change without notice.

About the Administrator Password

An administrator password "canon" is already specified for the printer at the time of purchase.

»» Important

- For security reasons, it is recommended to change the password before you use the printer.
- You can change the password using one of the tools below. (Some tools may not be available depending on the printer you are using.)
 - operation panel of the printer
 - IJ Network Tool
 - printer information screen displayed on some Canon application software
- When you change the password, use 0 to 32 alphanumeric characters.
- If the password has been changed while you are sharing the printer and you do not know the password, ask the administrator of the printer you are using.
- The password reverts to the default setting by initializing the printer settings.

List of Function for Each Model

- [MG series](#)
- [MX series](#)
- [MB series](#)
- [E series](#)
- [P series](#)
- [iP series](#)
- [iX series](#)
- [iB series](#)
- [PRO series](#)

MG series

Model name	Card slot
MG7530F	✓
MG7500	✓
MG7100	✓
MG6730	✓
MG6600	✓
MG6500	✓
MG6400	✓
MG5600	–
MG5500	–
MG3500	–
MG2900	–
MG2500	–
MG2400	–

MX series

Model name	Card slot
MX920	–
MX720	–
MX530	–
MX520	–
MX490	–
MX470	–
MX450	–
MX390	–

MB series

Model name	Card slot
MB5300	–
MB5000	–
MB2300	–
MB2000	–

E series

Model name	Card slot
E610	–
E560	–
E480	–
E460	–
E400	–

P series

Model name	Card slot
P200	–

iP series

Model name	Card slot
iP8700	–
iP2800	–
iP110	–

iX series

Model name	Card slot
iX6800	–
iX6700	–

iB series

Model name	Card slot
iB4000	–

PRO series

Model name	Card slot
PRO-100S	–

PRO-10S	-
---------	---

Printing



Printing from a Computer

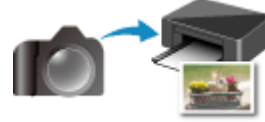

Printing from a Digital Camera

Printing from a Computer

- ▶ **Printing with Application Software that You are Using (Printer Driver)**

Printing with Application Software that You are Using (Printer Driver)

- ▶ **Printing with Easy Setup** 🍷 **Basic**
- ▶ **Various Printing Methods**
- ▶ **Changing the Print Quality and Correcting Image Data**
- ▶ **Overview of the Printer Driver**
- ▶ **Updating the Printer Driver**

Printing with Easy Setup

The simple setup procedure for carrying out appropriate printing on this printer is as follows:

1. [Check that the printer is turned on](#)
2. [Load paper](#) on the printer
3. Select the printer

Select your model from the **Printer** list in the [Print Dialog](#).

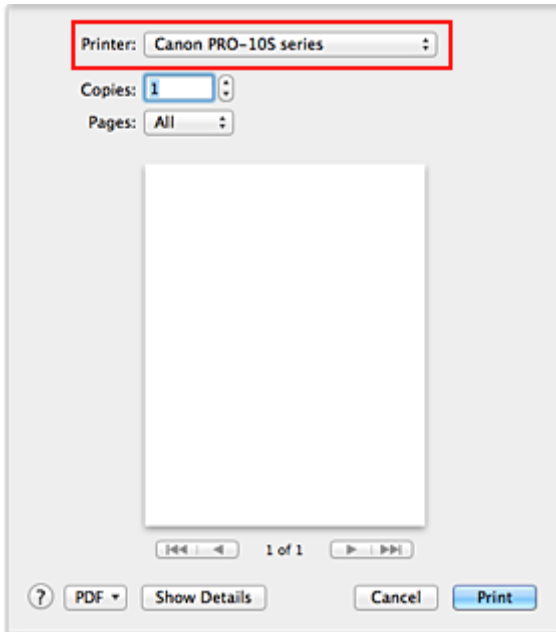

►►► Note

- Click **Show Details** to switch the Setup window to the detailed display.

4. Select the paper size

For **Paper Size**, select the paper size to be used.

If necessary, set the number of copies, the pages to be printed, and the orientation.

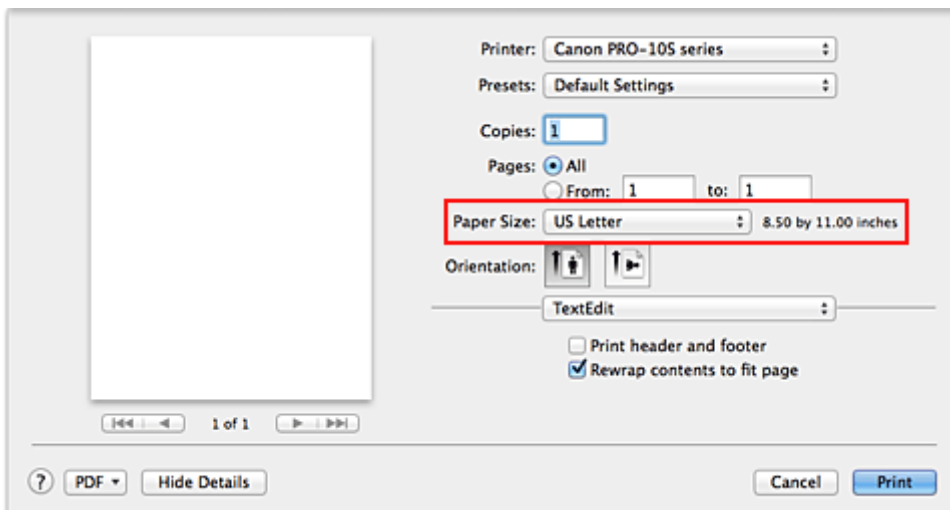

5. Select **Quality & Media** from the pop-up menu

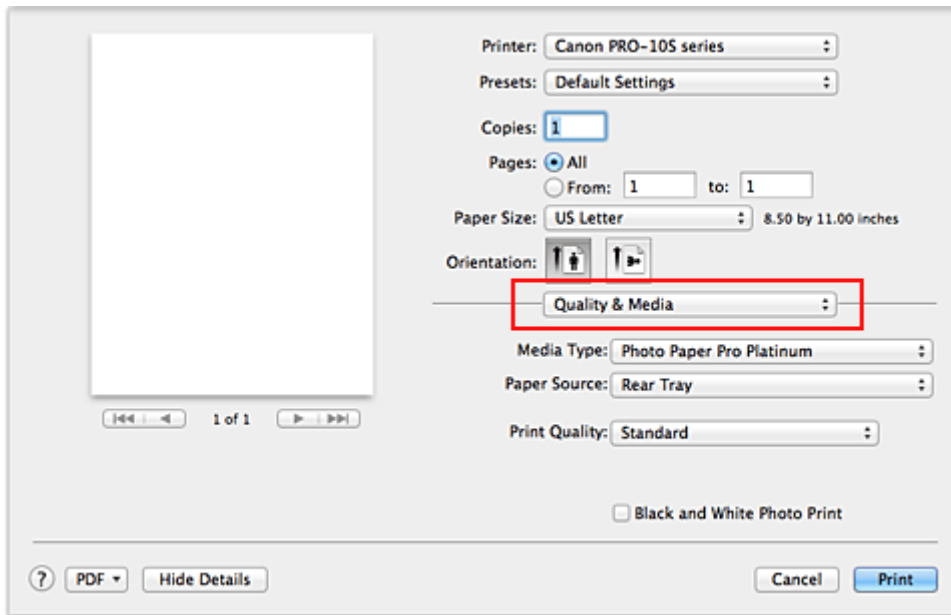

6. Select the media type

For **Media Type**, select the same paper type loaded in the printer.

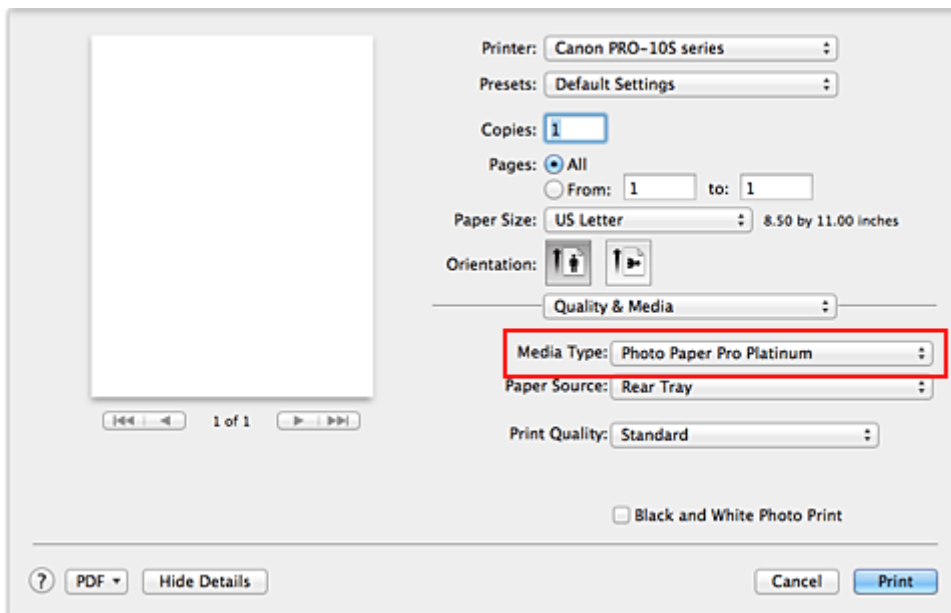

7. Select the paper source

Select **Manual Feed** or **Rear Tray** that matches your purpose for **Paper Source**.

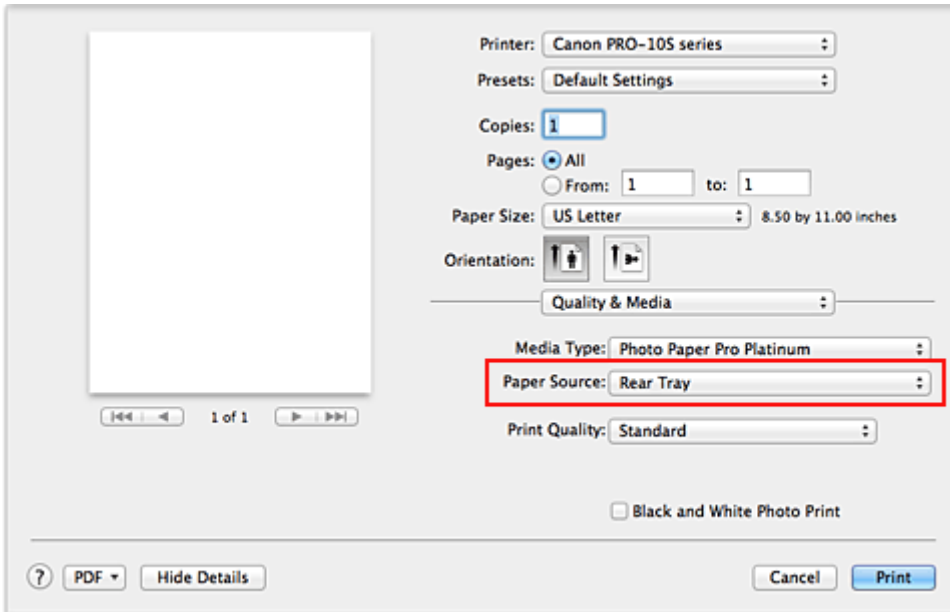

»»» Important

- The paper source settings that can be selected may differ depending on the paper type and size.

8. Select the print quality

For **Print Quality**, select **High**, **Standard**, or **Fast** according to your purpose.

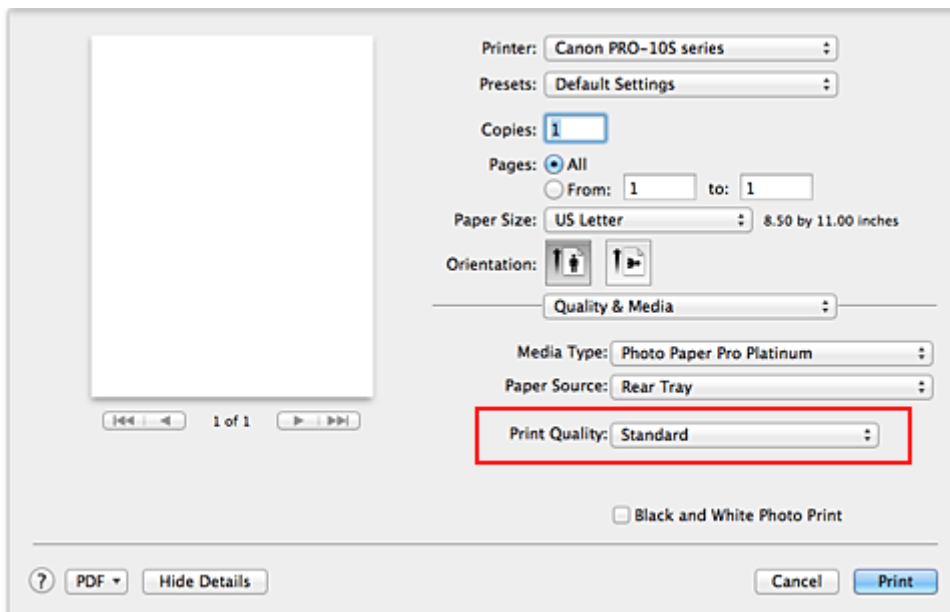

»»» Important

- Certain print quality levels cannot be selected depending on the settings of **Media Type**.

9. Complete the setup

Click **Print**.

When you execute print, the document will be printed in accordance with the type and size of the media.

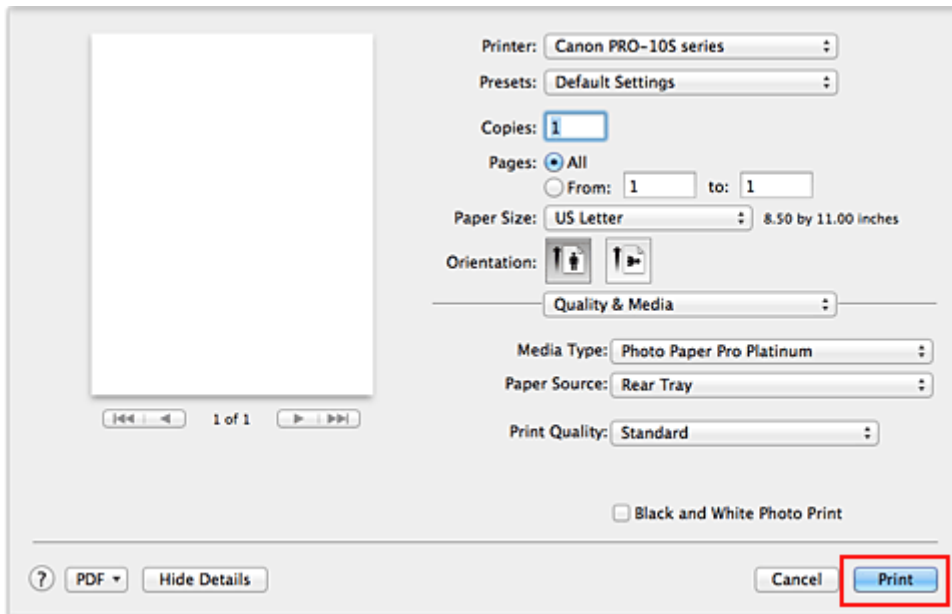

»» Important

- If you check the **Do not show again** check box when a guide message is displayed before printing starts, this will stop any more guide messages from being displayed.
- In the **Presets** section, click **Save Current Settings as Preset...** to [register the specified settings](#).
- To print on **Canvas, Fine Art "Museum Etching", or Photo Paper Pro Premium Matte**, follow the instructions displayed on the screen.

Paper Settings on the Printer Driver

When you use this printer, selecting a media type that matches the print purpose will help you achieve the best print results.

You can use the following media types on this printer.

Commercially available papers

Media name	Media Type in the printer driver
Plain Paper (including recycled paper)	Plain Paper

Canon genuine papers (Photo Printing)

Media name <Model No.>	Media Type in the printer driver
Photo Paper Plus Glossy II <PP-201>	Photo Paper Plus Glossy II
Photo Paper Pro Platinum <PT-101>	Photo Paper Pro Platinum
Photo Paper Pro Luster <LU-101>	Photo Paper Pro Luster
Photo Paper Plus Semi-gloss <SG-201>	Photo Paper Plus Semi-gloss
Matte Photo Paper <MP-101>	Matte Photo Paper

Canon genuine papers (Original Products)

Media name <Model No.>	Media Type in the printer driver
Photo Stickers <PS-101>	Photo Paper Plus Glossy II

Special paper (other than genuine Canon paper)

Media Features	Media Type in the printer driver
Media Types with Art Material Textures	Other Fine Art Paper 1 / Other Fine Art Paper 2
Media Types with Glossy Surfaces	Other Glossy Paper (Wide Margins) / Other Glossy Paper
Fabric that has the look of canvas	Canvas

»» Important

- When **Media Type** on the printer driver is set to **Other Glossy Paper (Wide Margins)**, **Fine Art "Museum Etching"**, **Photo Paper Pro Premium Matte**, **Other Fine Art Paper 1**, **Other Fine Art Paper 2**, or **Canvas**, no data is printed in the top and bottom 30 mm edges (printing direction) of the paper. For **Paper Size** on the printer driver, select "XXX (Art Paper Margin 30)". For information about the printable area, see "[Printing Area](#)."

Various Printing Methods

- ▶ **Setting the Number of Copies and Printing Order**
- ▶ **Setting the Stapling Margin**
- ▶ **Execute Borderless Printing**
- ▶ **Scaling the Printing to Fit the Paper Size**
- ▶ **Scaled Printing**
- ▶ **Page Layout Printing**
- ▶ **Printing on Postcards**
- ▶ **Changing the Clear Coating Settings**
- ▶ **Create or Delete a Form File**
- ▶ **Switching the Paper Source to Match the Purpose**
- ▶ **Setting Paper Dimensions (Custom Size)**

Setting the Number of Copies and Printing Order

Collate pages + Reverse Collate pages + Normal Reverse

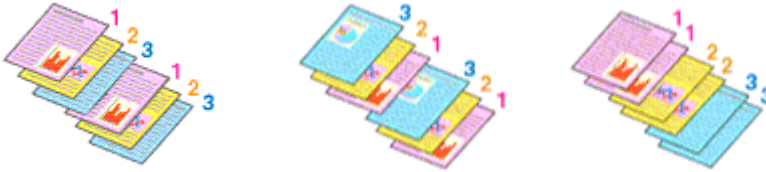

The procedure for specifying the number of copies and printing order is as follows:

1. Specify the number of copies to be printed

Specify the number of copies to print from the **Copies** in the [Print Dialog](#).

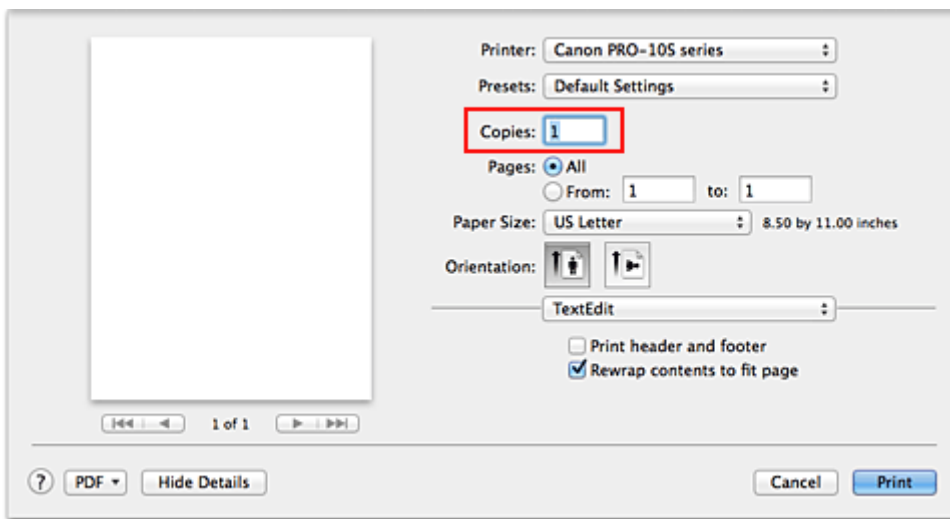

2. Select **Paper Handling** from the pop-up menu
3. Check the **Collate pages** check box when you are specifying multiple copies in the **Copies** box

Check the **Collate pages** check box to print all the pages of a single copy together. Uncheck this check box to print all pages with the same page number together.

4. Specify the print order

Check **Page Order**.

When you select **Automatic** or **Reverse**, printing starts from the last page.

When you select **Normal**, printing starts from the first page.

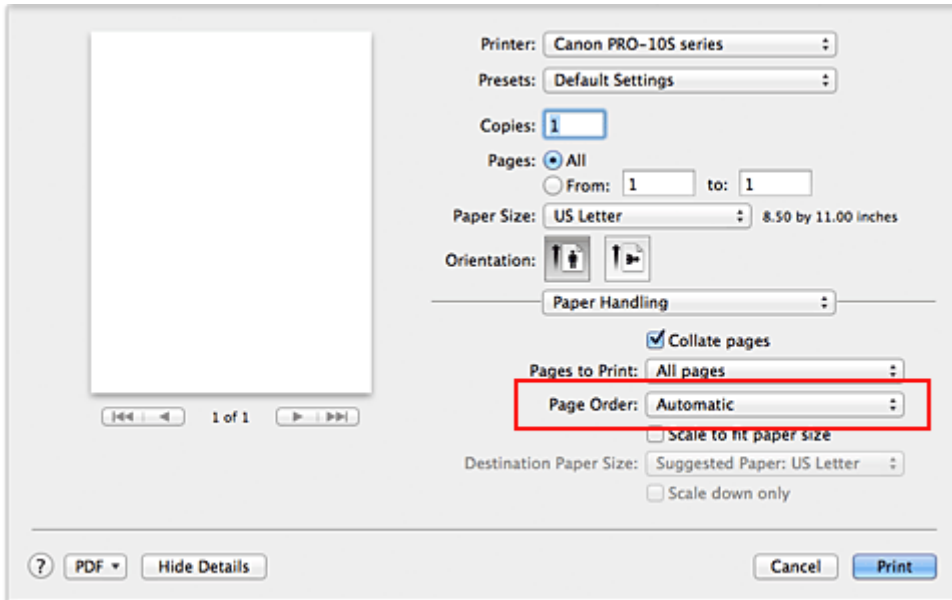

5. Complete the setup

Click **Print**.

When you execute print, the specified number of copies will be printed with the specified printing order.

▶▶▶ Important

- When the application software that you used to create the document has the same function, specify the settings on the printer driver. However, if the print results are not acceptable, specify the function settings on the application software. When you specify the number of copies and the printing order with both the application software and this printer driver, the number of copies may be multiplied numbers of the two settings or the specified printing order may not be enabled.

Setting the Stapling Margin

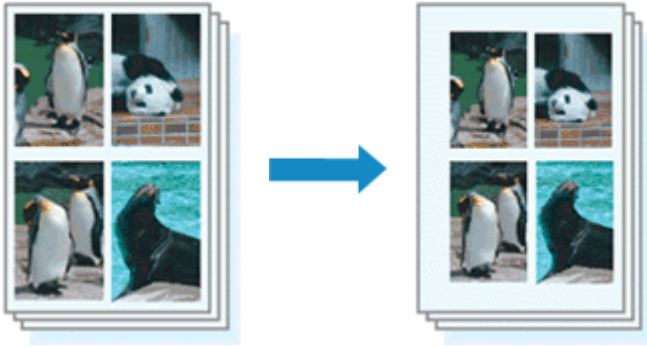

The procedure for setting the margin width and the staple side is as follows:

1. Select **Margin** from the pop-up menu on the [Print Dialog](#)

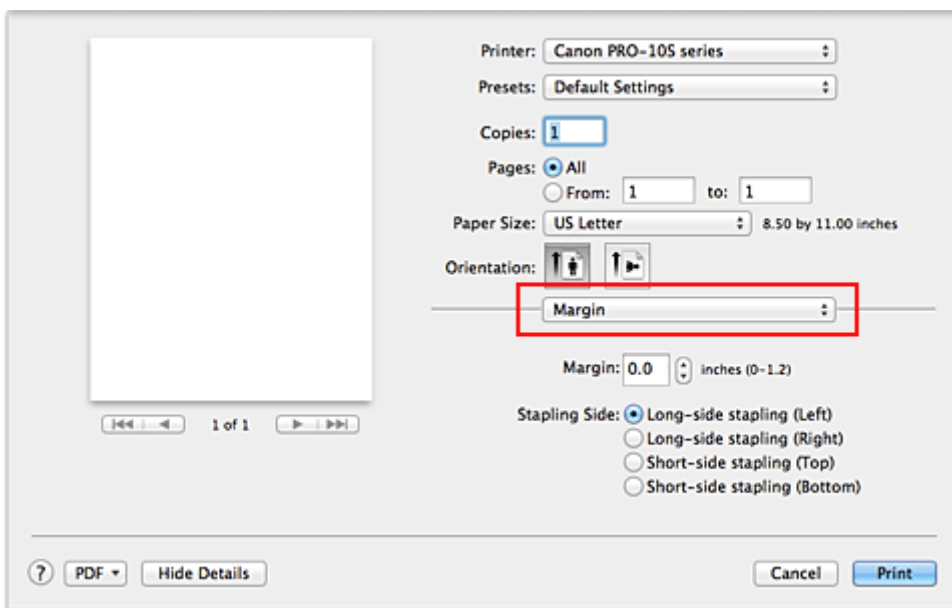

2. Set the margin width and the staple side

If necessary, set the **Margin** width, and select a stapling position from the **Stapling Side** list.

▶▶▶ Note

- The printer automatically reduces the print area depending on the staple position margin.

3. Complete the setup

Click **Print**.

When you execute print, the data is printed with the specified margin width and staple side.

▶▶▶ Important

- When borderless printing is enabled, **Margin** and **Stapling Side** appear grayed out and are unavailable.

Execute Borderless Printing

The borderless printing function allows you to print data without any margin by enlarging the data so that it extends slightly off the paper. In standard printing, margins are created around the document area. However, in borderless printing function, these margins are not created. When you want to print data such as a photo without providing any margin around it, set borderless printing.

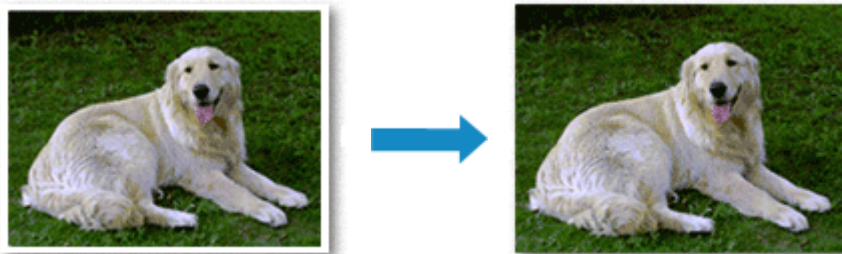

The procedure for performing borderless printing is as follows:

Setting Borderless Printing

1. Select the size of the paper for borderless printing

Select "XXX (borderless)" from the **Paper Size** in the [Print Dialog](#).

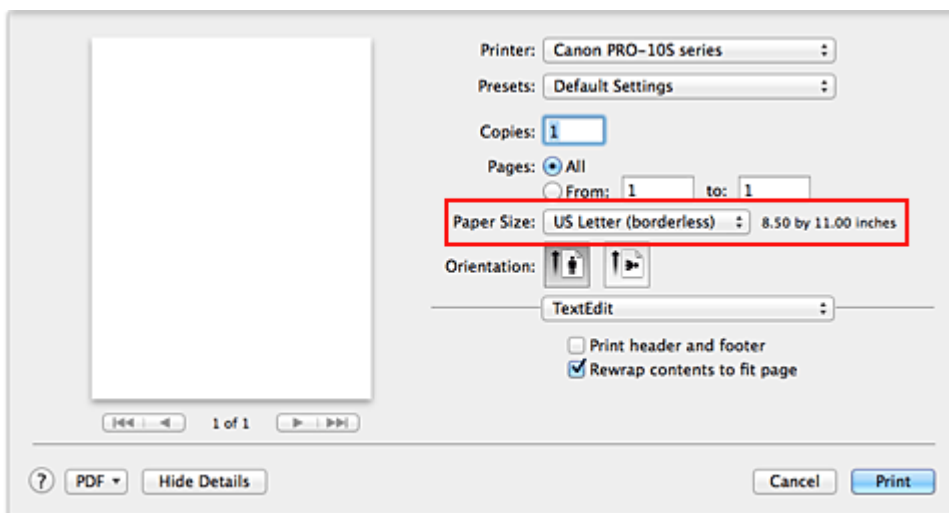

2. Select **Borderless Printing** from the pop-up menu

3. Adjust the amount of extension from the paper

If necessary, adjust the amount of extension using the **Amount of Extension** slider.

Moving the slider to the right increases the amount extending off the paper, and moving the slider to the left decreases the amount.

It is recommended to set the slider at the second position from the right for most cases.

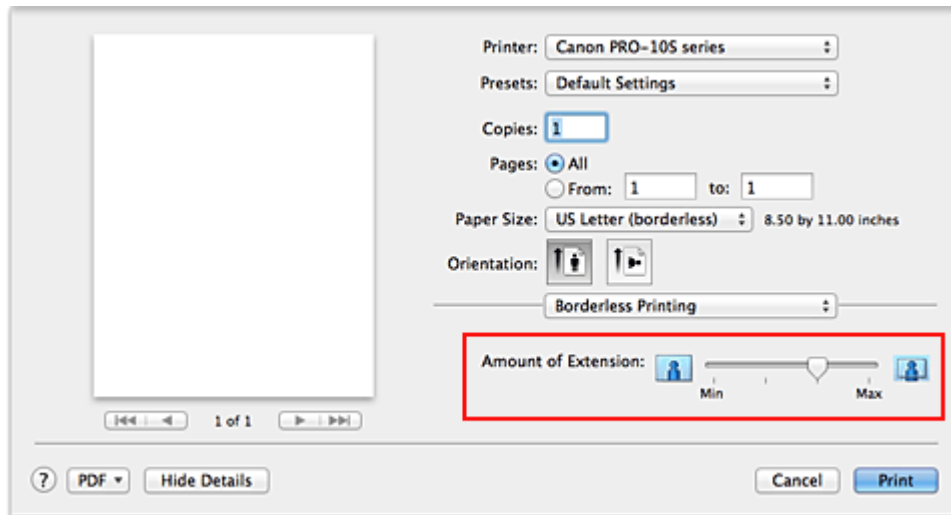

►► Important

- When the **Amount of Extension** slider is set to the rightmost position, the back side of the paper may become smudged.

4. Complete the setup

Click **Print**.

When you execute print, the data is printed without any margins on the paper.

►► Important

- Borderless printing only supports specific paper sizes. Make sure to select a paper size with the wording "(borderless)" from the **Paper Size**.
- If borderless printing is enabled, only the following selections are available from the Print dialog when you display the pop-up menu and click **Quality & Media** and then **Media Type: Photo Paper Plus Glossy II, Photo Paper Pro Platinum, Photo Paper Pro Luster, Photo Paper Plus Semi-gloss, Matte Photo Paper, Other Glossy Paper, and Ink Jet Hagaki**.
- Print quality may deteriorate or the sheet may be stained at the top and bottom depending on the type of paper used.
- When the ratio of the height to the width differs from the image data, a portion of the image may not be printed depending on the size of the media used.
In this case, crop the image data with an application software according to the paper size.
- When scaled printing or page layout printing is enabled, you cannot perform borderless printing.

Expanding the Range of the Document to Print

Setting a large amount of extension allows you to perform borderless printing with no problems. However, the portion of the document extending off the paper range will not be printed and for this reason, the subjects around the perimeter of a photo may not be printed.

When you are not satisfied with the result of borderless printing, reduce the amount of extension. The extension amount decreases as the **Amount of Extension** slider is moved to the left.

►► Important

- When the amount of extension is decreased, an unexpected margin may be produced on the print, depending on the size of the paper.

»» Note

- When the **Amount of Extension** slider is set to the leftmost position, image data will be printed in the full size. If you set this when printing the address side of a postcard, the postal code of the sender is printed in the correct position.

Scaling the Printing to Fit the Paper Size



The procedure for printing a document that is automatically enlarged or reduced to fit the paper size to be used is as follows:

1. Check the paper size

Check that the **Paper Size** in the [Print Dialog](#) is the same as the paper size that you set in the application software.

2. Select **Paper Handling** from the pop-up menu

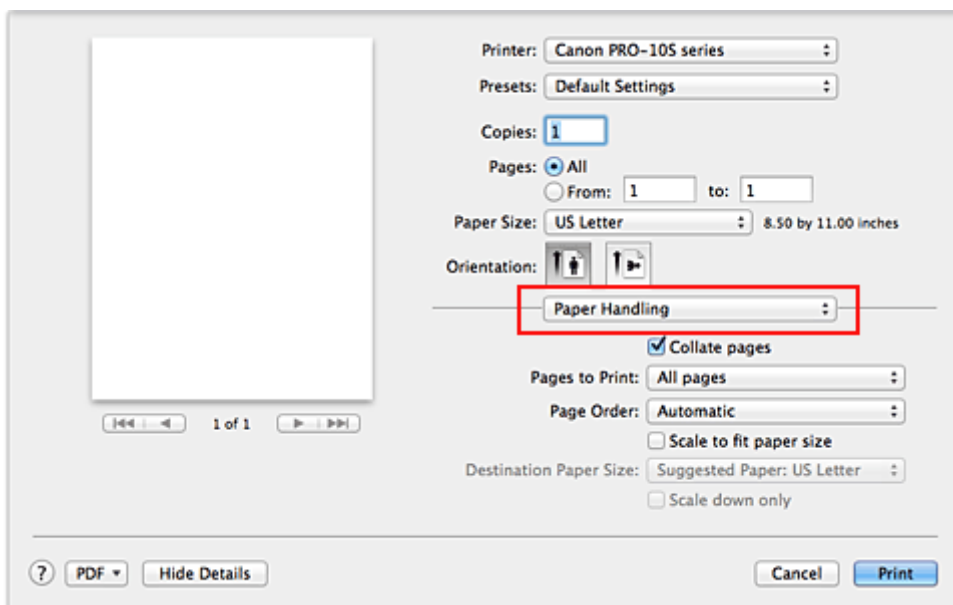

3. Set the print paper size

Check the **Scale to fit paper size** check box. Then from the **Destination Paper Size** pop-up menu, select the paper size that is actually loaded in the printer.

4. If necessary, check the **Scale down only** check box

When you check this check box, the document will be reduced to fit to the paper size when the document size is larger than the page size. The document will be printed in the original size when the document size is smaller than the page size.

5. Complete the setup

Click **Print**.

When you execute print, the document will be enlarged or reduced to fit to the page size.

Scaled Printing

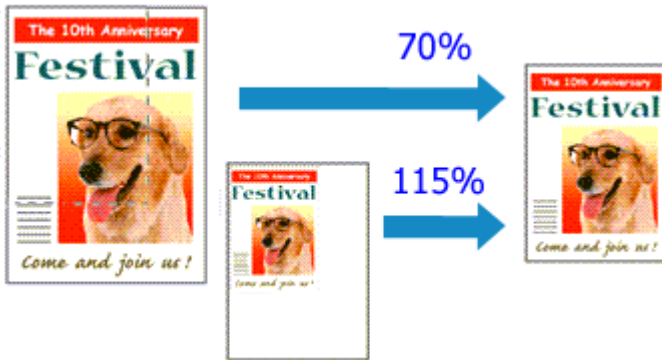

The procedure for printing a document with pages enlarged or reduced is as follows:

1. Select the printer

In the [Page Setup Dialog](#), select your model name from the **Format For** list.

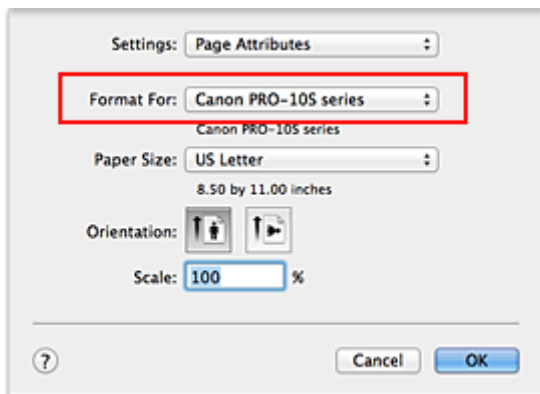

2. Set scaled printing

Specify the scaling factor in the **Scale** box, and click **OK**.

▶▶▶ Note

- Depending on the **Scale** value that you set, an error message may be displayed.

3. Complete the setup

On the [Print Dialog](#), click **Print**.

When you execute print, the document will be printed with the specified scale.

▶▶▶ Important

- When the application software which you used to create the original has the scaled printing function, configure the settings on your application software. You do not need to configure the same setting in the Page Setup dialog.

Page Layout Printing

The page layout printing function allows you to print more than one page image on a single sheet of paper.

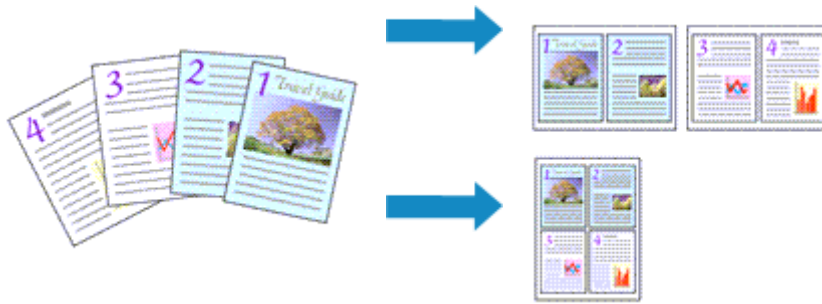

The procedure for performing page layout printing is as follows:

1. Select **Layout** from the pop-up menu in the [Print Dialog](#)

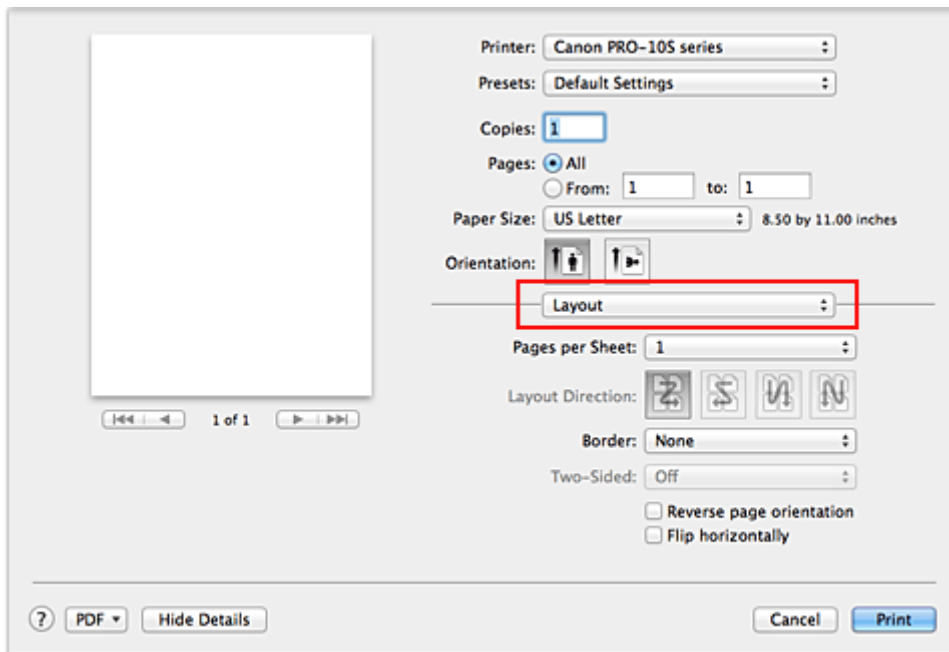

2. Set the number of original you print on one page

In **Pages per Sheet**, specify the number of page you print on one page.

3. If necessary, set the following items

Layout Direction

To change the page placement order, select an icon from the list.

Border

To print a page border around each document page, select a type of page border.

Reverse page orientation

Select this check box to change the paper orientation.

Flip horizontally

Select this check box to reverse left and right of the document.

4. Complete the setup

Click **Print**.

When you execute print, the specified number of pages will be arranged on each sheet of paper in the specified order.

Printing on Postcards

This section describes the procedure for postcard printing.

1. [Load postcard](#) on the printer
2. Select paper size in the [Print Dialog](#)

Select **Postcard** or **Postcard Double** from the **Paper Size** menu.

»»» Important

- Return postcards can be used only when you print them from the computer.
- When printing a return postcard, always set the paper size to **Postcard Double** from your application software or the printer driver.
- Do not fold the return postcard. If a crease is formed, the printer will not be able to feed the postcard properly, and this condition will cause line shifts or a paper jam.
- With return postcards, borderless printing cannot be used.

3. Select **Quality & Media** from the pop-up menu
4. Select the media type

For **Media Type**, select the same paper type loaded in the printer.

»»» Important

- This printer cannot print on postcards that have photos or stickers attached.
- When printing on each side of a postcard separately, you will get cleaner printing if you print the message side first and then print the address side.

5. Complete the setup

Click **Print**.

When you execute printing, the data will be printed onto the postcard.

»»» Important

- If you check the **Do not show again** check box when a guide message is displayed before printing starts, this will stop any more guide messages from being displayed.

Changing the Clear Coating Settings

When you execute clear coating, the printer applies chroma optimizer (CO) ink onto the printing surface and allows you to adjust the glossiness.

You can also create the areas to be clear-coated and save the area information as a form. When you use a form to perform clear coating, you can achieve decorative effects that cause certain characters and patterns to pop out.

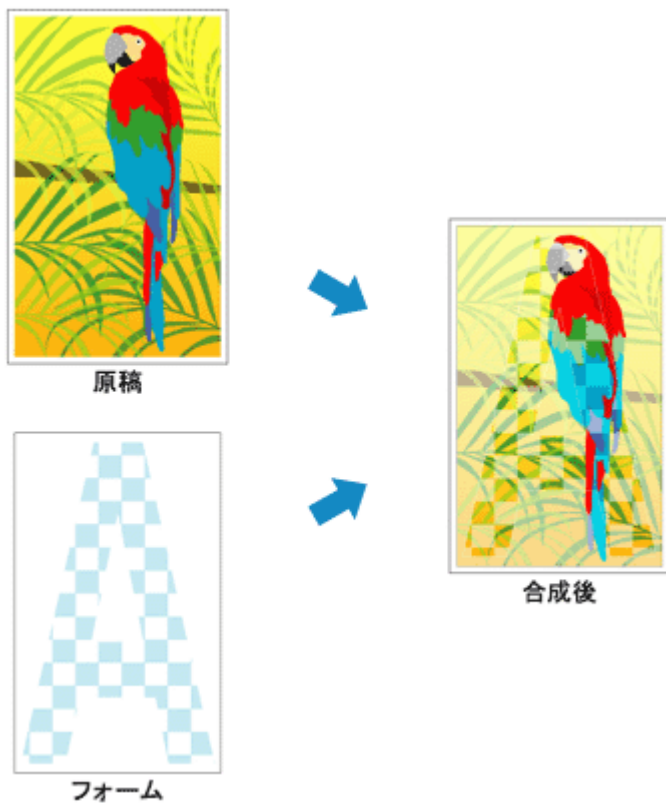

This section explains procedures for changing the clear coating settings.

1. From the [Print Dialog](#), display the pop-up menu, and select **Clear Coating**
2. Setting the clear coating area
Select **Auto**, **Overall**, or **Custom** that matches your purpose for **Clear Coating Area**.

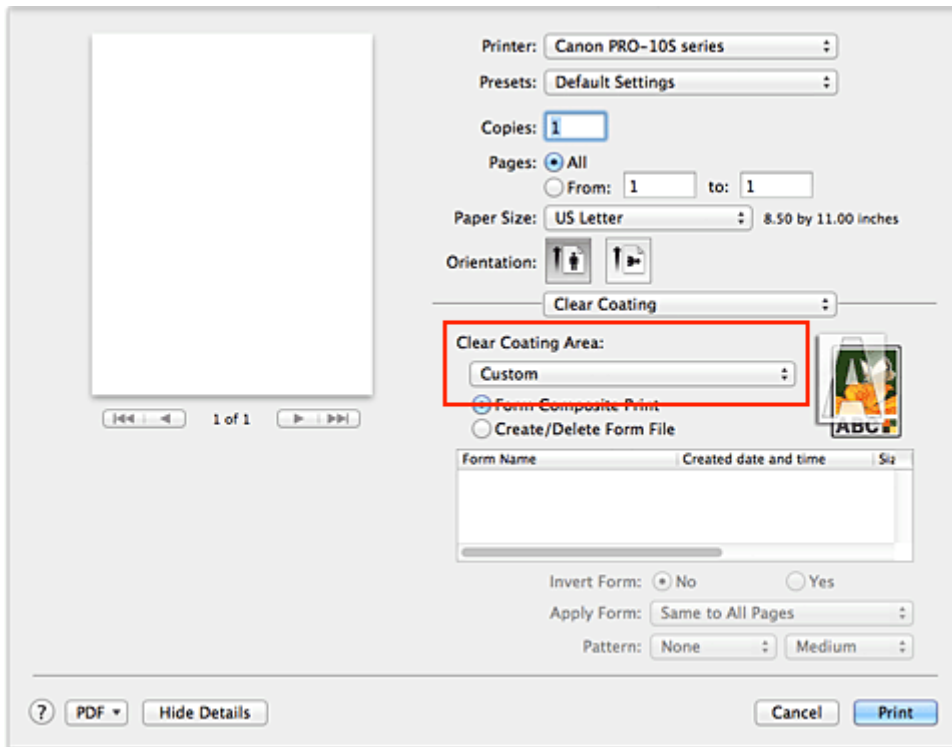

Auto

The printer automatically sets the areas to be clear-coated and whether clear coating is to be executed.

It may be possible to reduce the ink consumption of the chroma optimizer (CO) or to accelerate the print speed.

Overall

The printer clear-coats the entire print area.

If selecting **Auto** produced unsatisfactory clear coating effects, selecting **Overall** may improve the results.

Custom

Use a form to specify the clear coating areas.

Select this option also when you are creating or deleting a form.

If you select **Auto** or **Overall**, go to step 5.

If you select **Custom**, perform the subsequent steps.

»»» Important

- On the **Quality & Media**, look at **Media Type**. If a media type other than **Photo Paper Plus Glossy II**, **Photo Paper Pro Platinum**, **Photo Paper Pro Luster**, **Photo Paper Plus Semi-gloss**, **Other Glossy Paper (Wide Margins)**, or **Other Glossy Paper** is selected, you cannot select **Overall** or **Custom**.
- Depending on which print quality is set on the **Quality & Media**, you may not be able to select **Custom**.
- If **Overall** is selected and the media type is changed to one that cannot use **Overall**, the clear coating area setting is changed to **Auto**.
- If **Custom** is selected and the media type or the print quality is changed to one that does not support form composite print or form file creation, the clear coating area setting is changed to **Auto**.

3. Selecting a form file

Click **Form Composite Print**, and then from form files, select the form file to be used.

The white areas of the selected form become the clear coating areas. Clear coating is not applied to the non-white areas.

▶▶▶ Note

- To display form files in a list, you must first [create form files](#).
- You can rearrange the displayed form files by clicking the list heading.

4. Set the form details

If necessary, specify the following settings.

Invert Form

You can reverse the clear coating areas.

Apply Form

Set the method for applying the form to the document pages.

To apply the first page of the selected form to the entire document, select **Same to All Pages**.

To make the document and the form correspond in sequence from the first page, select **Individual Page**.

Pattern

Select the pattern type and size from the list.

The pattern is applied to areas that are not clear coated.

5. Complete the setup

Click **Print**.

When printing is executed, the clear coating effect that was set is added when the document is printed.

▶▶▶ Important

- The decorative effects of clear coating may diminish depending on the document to be clear coated.
- Selecting **Black and White Photo Print** on the **Quality & Media** may diminish the decorative effects of clear coating.

Related Topic

- [Create or Delete a Form File](#)

Create or Delete a Form File

You can create clear coating areas by using the application software of your choice, and save those areas as a form. An unnecessary form file can be deleted.

This section describes the procedure for creating a form file.

Create a Form File

1. Creating data for use as a form file

Using the application software of your choice, create data that contains the characters and patterns to be used as the form file.

The white areas of the created data become the clear coating areas. Clear coating is not applied to the non-white areas.

2. From the [Print Dialog](#), display the pop-up menu, and select **Clear Coating**

3. Selecting **Create/Delete Form File**

Select **Custom** from the **Clear Coating Area** menu, and then select **Create/Delete Form File**.

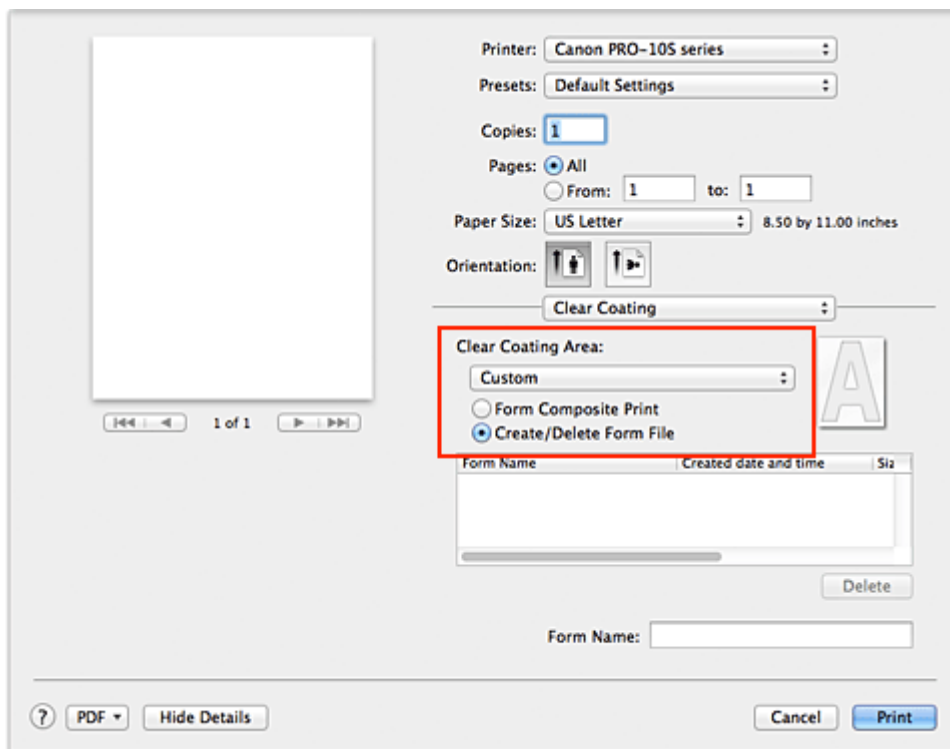

4. Setting the form name

In **Form Name**, enter the name of the form to be created.

▶▶▶ Note

- Spaces, tabs, and returns cannot be entered at the beginning or end of a form name.
- You cannot set a form name that is the same as the name of an existing form file.
- You cannot change the name of the created form.

5. Complete the setup

Click **Print**.

When you execute printing, the data that you created using the application software is saved as a form file.

»» Important

- To create a form file, you must connect this printer to your computer and turn on the printer.
- When **Create/Delete Form File** is selected, printing is not actually performed from the printer even if printing is executed.
- **Form Composite Print** and **Create/Delete Form File** can be executed only from the Print Dialog. Some applications do not support these functions.

»» Note

- To display the created form files on the list, you must display the pop-up menu and select **Clear Coating** again.
- When creating a form file, use the same settings (such as **Paper Size** and **Borderless Printing**) that were used for form composite print.
- You can register up to 30 form files.

Deleting Unnecessary Form File

1. From the [Print Dialog](#), display the pop-up menu, and select **Clear Coating**
2. Selecting **Create/Delete Form File**
Select **Custom** from the **Clear Coating Area** menu, and then select **Create/Delete Form File**.
3. Select the form file to be deleted
From form files, select the form file to be deleted.
4. Delete the form file
Click **Delete**. When the confirmation message appears, click **OK**.
The selected form file is deleted from the form files.

»» Important

- To delete a form file, you must connect this printer to your computer and turn on the printer.

Switching the Paper Source to Match the Purpose

In this printer, there are two paper sources, a manual feed tray and a rear tray. You can facilitate printing by selecting a paper source setting that matches your media type or purpose.

The procedure for setting paper source is as follows:

1. Select **Quality & Media** from the pop-up menu of the [Print Dialog](#)
2. Select the media type

For **Media Type**, select the same paper type loaded in the printer.

►►► Note

- When **Other Glossy Paper (Wide Margins)**, **Fine Art "Museum Etching"**, **Photo Paper Pro Premium Matte**, **Other Fine Art Paper 1**, **Other Fine Art Paper 2**, or **Canvas** is selected for **Media Type** in the Print Dialog, select "XXX (Art Paper Margin 30)" for **Paper Size**.

3. Select the paper source

For **Paper Source**, select the item below that matches your purpose.

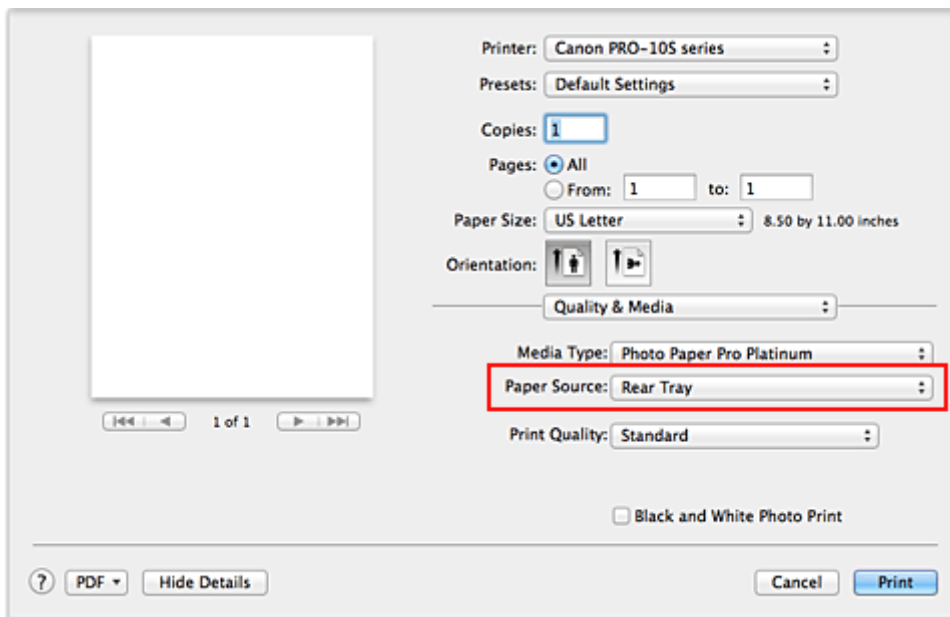

Manual Feed

Paper is supplied from the manual feed tray in the back.

►►► Important

- When **4 x 6**, **5 x 7**, **A5**, **JIS B5**, **L**, **Postcard** or **Postcard Double** is selected for **Paper Size** on the Print Dialog, paper cannot be supplied from the manual feed tray in the back.
- When **Plain Paper**, **Hagaki A**, **Ink Jet Hagaki**, or **Hagaki** is selected from the **Media Type** menu of the **Quality & Media** on the pop-up menu in the Print dialog, paper cannot be supplied from the manual feed tray in the back.

Rear Tray

Paper is fed from the rear tray.

»» Important

- When **14"x17" 36x43cm** is selected for **Paper Size** on the Print Dialog, paper cannot be supplied from the rear tray.
- When **Fine Art "Museum Etching"**, **Photo Paper Pro Premium Matte** or **Canvas** is selected from the **Media Type** menu of the **Quality & Media** on the pop-up menu in the Print dialog, paper cannot be supplied from the rear tray.

4. Complete the setup

Click **Print**.

When you execute print, the printer uses the specified paper source to print the data.

Setting Paper Dimensions (Custom Size)

You can specify the height and width of paper when its size cannot be selected from the **Paper Size** menu. Such a paper size is called "custom size."

The procedure for specifying a custom size is as follows:

1. Creating a new custom paper size

In the [Print Dialog](#), select **Manage Custom Sizes...** from **Paper Size**.

In the **Custom Paper Sizes** dialog, click **+**.

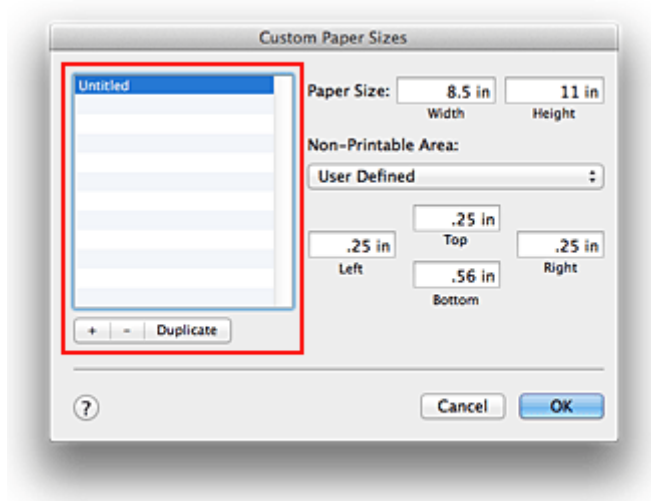

Untitled will be added to the list.

2. Setting details about the custom paper size

Double-click **Untitled**, enter the name of the paper size you want to register, and specify the **Width** and **Height** of the paper for **Paper Size**.

Select **User Defined** or your model for **Non-Printable Area**, and enter the margins.

3. Registering the custom paper size

Click **OK**.

The custom size is registered.

►► Important

- If the application software that created the document has a function for specifying height and width values, use the application software to set the values. If the application software does not have such a function or if the document does not print correctly, perform the above procedure from the printer driver to set the values.
- When you use a custom page size, correctly set the size of the paper loaded in the printer in the **Custom Paper Sizes** dialog.
If an error message is displayed even though paper of the same size that was specified is loaded, select **Custom Settings** from the pop-up menu of Canon IJ Printer Utility, and uncheck the **Detect paper width** check box.

►► Note

- To duplicate the registered paper size, select the paper size that you want to duplicate from the **Custom Paper Sizes** list, and click **Duplicate**.

- To delete a registered paper size, select the paper size that you want to delete from the **Custom Paper Sizes** list, and click -.
-

Related Topic

- [Changing the Printer Operation Mode](#)

Changing the Print Quality and Correcting Image Data

- ▶ **Setting the Print Quality Level (Custom)**
- ▶ **Printing a Color Document in Monochrome**
- ▶ **Adjusting Tone**
- ▶ **Specifying Color Correction**
- ▶ **Optimal Photo Printing of Image Data**
- ▶ **Adjusting Colors with the Printer Driver**
- ▶ **Printing with ICC Profiles (Specifying an ICC Profile from the Application Software)**
- ▶ **Printing with ICC Profiles (Specifying an ICC Profile from the Printer Driver)**
- ▶ **Interpreting the ICC Profile**
- ▶ **Adjusting Color Balance**
- ▶ **Adjusting Brightness**
- ▶ **Adjusting Intensity**
- ▶ **Adjusting Contrast**

Setting the Print Quality Level (Custom)

The print quality level can be set in the **Custom**.

The procedure for setting the print quality level is as follows:

1. Select **Quality & Media** from the pop-up menu on the [Print Dialog](#)
2. Select the print quality
Select **Custom** for **Print Quality**.

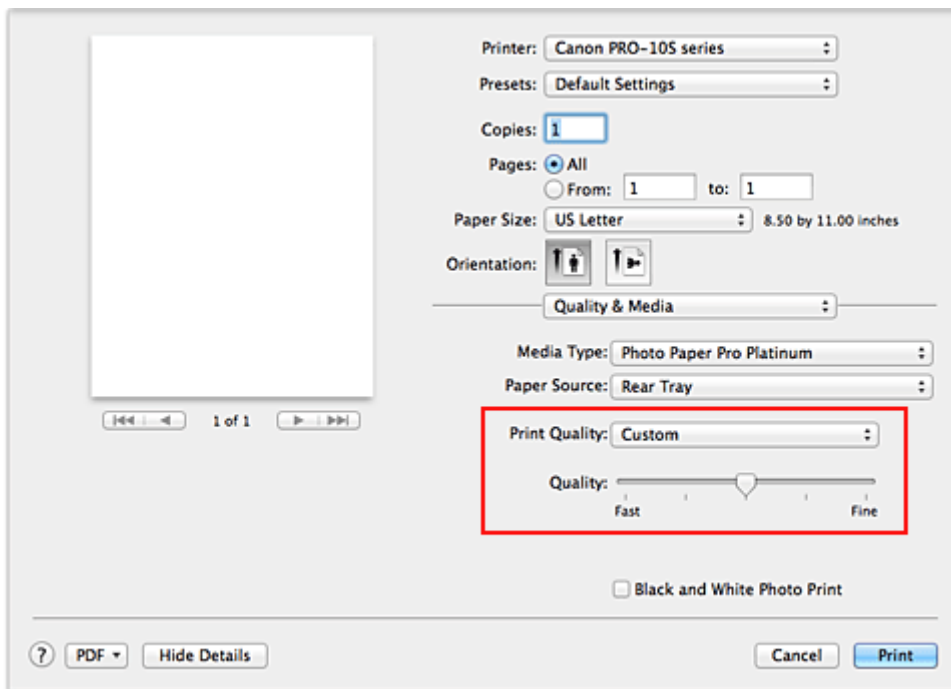

3. Setting the print quality level

Move the **Quality** slider to select the print quality level.

4. Complete the setup

Click **Print**.

When you execute print, the image data is printed with the selected print quality level.

►► Important

- Certain print quality levels cannot be selected depending on the settings of **Media Type**.

Related Topics

- [Specifying Color Correction](#)
- [Adjusting Color Balance](#)
- [Adjusting Brightness](#)
- [Adjusting Intensity](#)
- [Adjusting Contrast](#)

Printing a Color Document in Monochrome

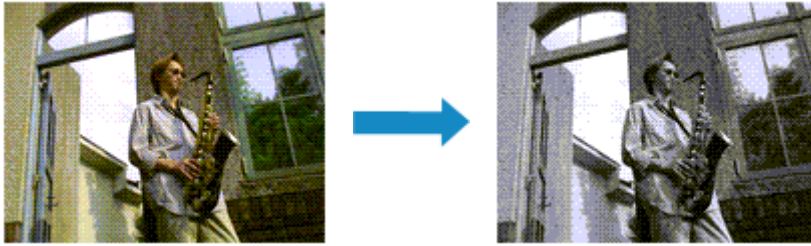

The procedure for printing a color document in monochrome is as follows:

1. Select **Quality & Media** from the pop-up menu on the [Print Dialog](#)
2. Set black and white photo printing

Check the **Black and White Photo Print** check box.

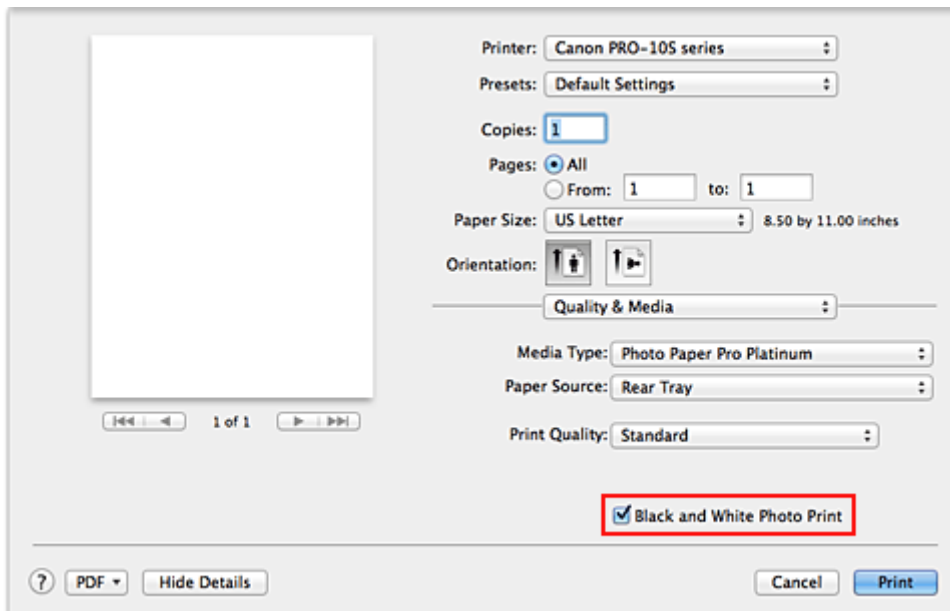

3. Complete the setup

Click **Print**.

When you execute print, the document is converted to grayscale data. It allows you to print the color document in monochrome.

▶▶▶ Note

- During **Black and White Photo Print**, inks other than black ink may be used as well.

Related Topic

- [Adjusting Tone](#)

Adjusting Tone

When printing black and white photos, you can produce the cooling effects of cool colors and the warming effects of warm colors.



Cool Tone is selected **Black and White** is selected **Warm Tone** is selected

The procedure for adjusting tone is as follows:

1. Select **Quality & Media** from the pop-up menu of the [Print Dialog](#)
2. Select the media type
For **Media Type**, select the same media type loaded in the printer.
3. Set black and white photo printing

Check the **Black and White Photo Print** check box.

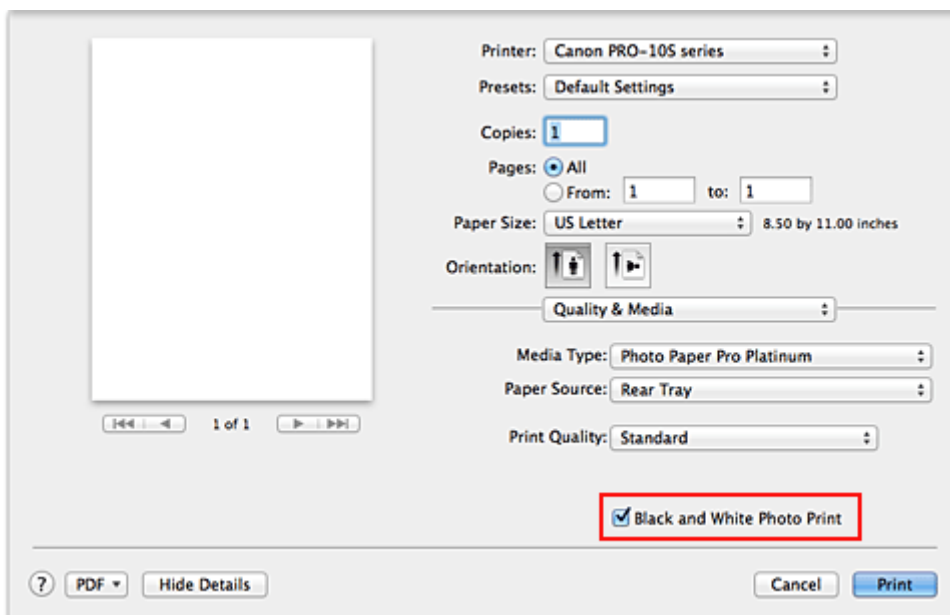

4. Select **Color Options** from the pop-up menu
5. Adjusting monochrome tones

Specify one of the following items from **Tone**. The selected value will be shown in the preview on the left side.

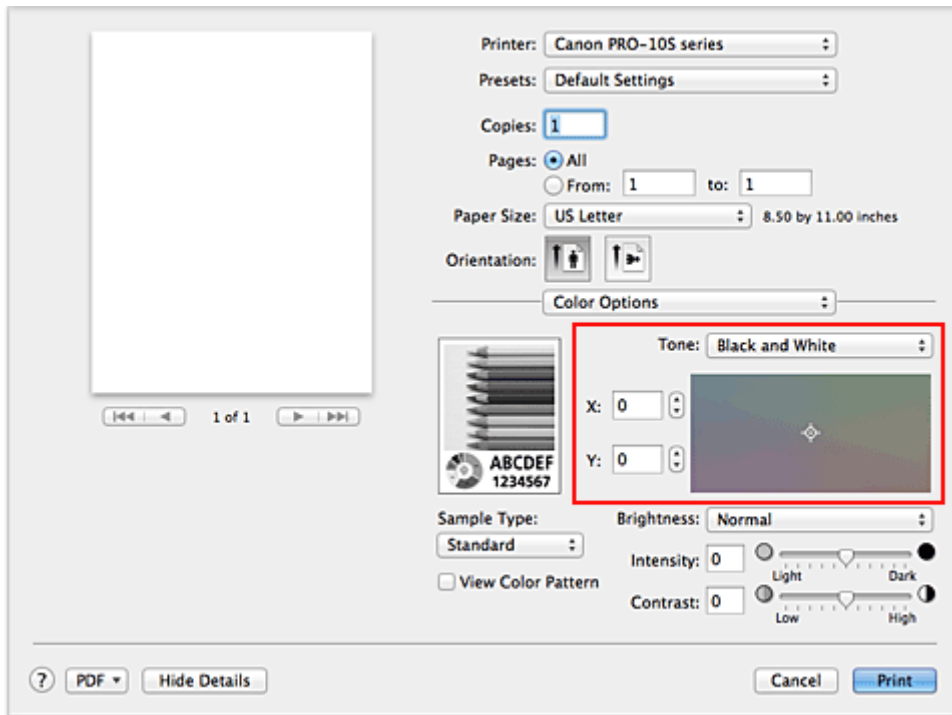

Cool Tone

This item adjusts color tones to cool shades (cool black). When you select **Cool Tone**, a value of -30 is entered for **X**, and a value of 0 for **Y**.

Black and White

This item adjusts color tones to neutral shades. When you select **Black and White**, a value of 0 is entered for **X**, and a value of 0 for **Y**.

Warm Tone

This item adjusts color tones to warm shades (warm black). When you select **Warm Tone**, a value of 30 is entered for **X**, and a value of 0 for **Y**.

Custom

You can adjust the color tones while checking the colors in the adjustment area.

To adjust the color tones, either enter values directly or click the up/down arrows. When you enter values, set values in the range of -100 to 100 for **X**, and -50 to 50 for **Y**.

You can also adjust the color tones by clicking or dragging the adjustment area with the mouse.

If you select another color tone and then select **Custom** again, the values that were preset in **Custom** are restored.

Important

- **Tone** and **X, Y** (Monochromatic adjustment value) are displayed when **Black and White Photo Print** check box is selected for **Quality & Media**.

6. If necessary, adjust monochromatic colors manually

To adjust the color tones, either enter values directly to **X** or **Y** (Monochromatic adjustment value) or click the up/down arrows.

You can also adjust the color tones by clicking or dragging the adjustment area with the mouse.

7. Complete the setup

Click **Print**.

When you execute print, the color document is converted to grayscale data with adjusted tones. It allows you to print the color document in monochrome.

»» Important

- If you select **ColorSync** for **Color Matching**, then **Tone, X, and Y** appear grayed out and are unavailable.

Related Topics

- [Printing a Color Document in Monochrome](#)
- [Adjusting Brightness](#)
- [Adjusting Intensity](#)
- [Adjusting Contrast](#)

Specifying Color Correction

You can specify the color correction method suited to the type of document to be printed. Normally, when data is printed, the printer driver automatically adjusts the colors.

When you want to print by using the color space (Adobe RGB or sRGB) of the image data effectively or by specifying a printing ICC profile from your application software, select **ColorSync**. When you want to print by having the printer driver correct the colors, select **Canon Color Matching**.

The procedure for specifying color correction is as follows:

1. Select **Color Matching** from the pop-up menu of the [Print Dialog](#)

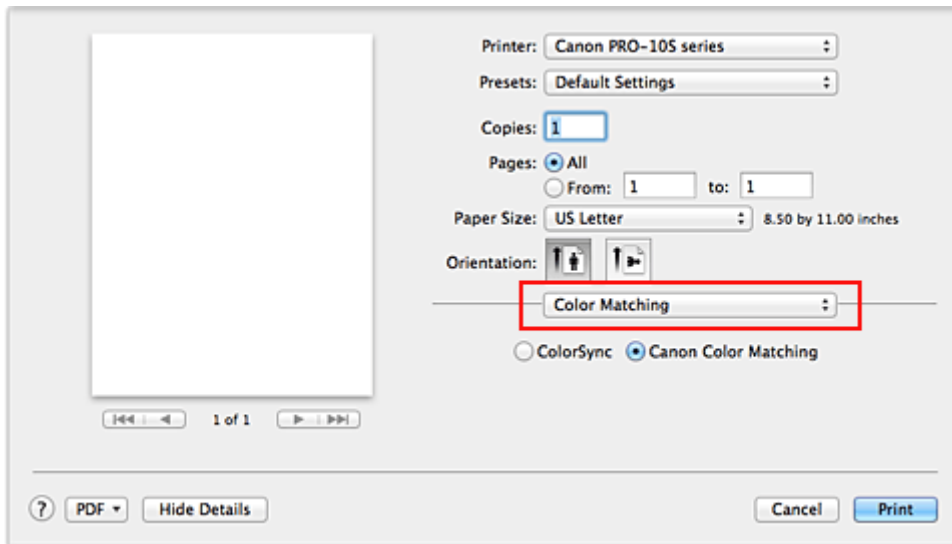

2. Select color correction

Select the item below that matches your purpose.

ColorSync

Perform color correction using ColorSync.

Canon Color Matching

Print in PRO mode.

For information about PRO mode, see "[Adjusting Colors with the Printer Driver](#)."

3. Complete the setup

Click **Print**.

When you execute print, the document data is printed with the specified color correction.

Important

- Depending on the application software, when a printing ICC profile is specified from that application software, **Canon Color Matching** cannot be selected because **ColorSync** is selected automatically.
- The **Quality & Media** setting is necessary even when **ColorSync** or **Canon Color Matching** is selected.

Related Topics

- [Optimal Photo Printing of Image Data](#)
- [Adjusting Colors with the Printer Driver](#)
- [Printing with ICC Profiles \(Specifying an ICC Profile from the Application Software\)](#)

- [Printing with ICC Profiles \(Specifying an ICC Profile from the Printer Driver\)](#)
- [Interpreting the ICC Profile](#)

Optimal Photo Printing of Image Data

When people print images taken with digital cameras, they sometimes feel that the printed color tones differ from those of actual image or those displayed on the monitor.

To get the print results as close as possible to the desired color tones, you must select a printing method that is best suited to the application software used or to your purpose.

Color Management

Devices such as digital cameras, scanners, monitors, and printers handle color differently. Color management (color matching) is a method that manages device-dependent "colors" as a common color space.

For Mac OS, a color management system called "ColorSync" is built into the operating system. Adobe RGB and sRGB are popularly used as common color spaces. Adobe RGB has a wider color space than sRGB.

ICC profiles convert device-dependent "colors" into a common color space. By using an ICC profile and carrying out color management, you can draw out the color space of the image data within the color reproduction area that the printer can express.

▶▶ Note

- Normally, image files are saved in JPEG format. Some digital cameras allow you to save images in a format called RAW. RAW data refers to an image saving format that requires a computer to develop the image. You can embed an input ICC profile tag into a RAW file by using special application software.

Selecting a Printing Method Suited to the Image Data

The recommended printing method depends on the color space (Adobe RGB or sRGB) of the image data or the application software to be used.

There are two typical printing methods.

Check the color space (Adobe RGB or sRGB) of the image data and the application software to be used, and then select the printing method suited to your purpose.

[Adjusting Colors with the Printer Driver](#)

Describes the procedure for printing by using the color correction function of the printer driver.

Print in PRO mode.

Select this function when you want to print impressions that are close to those displayed on the monitor, for example, if you corrected the colors while checking the print image on the monitor.

[Printing with ICC Profiles \(Specifying an ICC Profile from the Application Software\)](#)

Describes the procedure for printing by using the color space of Adobe RGB or sRGB effectively.

You can print with a common color space by setting up the application software and the printer driver so that the color management matches the input ICC profile of the image data.

The method for setting up the printer driver differs depending on the application software to be used.

Related Topic

- [Interpreting the ICC Profile](#)

Adjusting Colors with the Printer Driver

To print in PRO mode, specify the color correction function of the printer driver. PRO mode accurately applies the characteristics of data displayed on the monitor and allows you to obtain print results of impressions that are close to those displayed on the monitor.

▶▶▶ Important

- When you print in PRO mode, Canon recommends that you set the monitor and the environment light as follows:
 - Monitor
 - Color temperature: D50 (5000K)
 - Brightness: 120 cd/m²
 - Gamma: 2.2
 - Environment light
 - Fluorescent light for D50 color evaluation (color temperature 5000K, high color rendering properties)
 - Brightness when looking at printed materials: 500 lx ± 125 lx

▶▶▶ Note

- When printing from an application software that allows you to identify and specify ICC profiles, use an ICC profile for printing with that application software and select setting items that manage colors.

The procedure for adjusting colors with the printer driver is as follows:

1. Select **Color Matching** from the pop-up menu of the [Print Dialog](#)

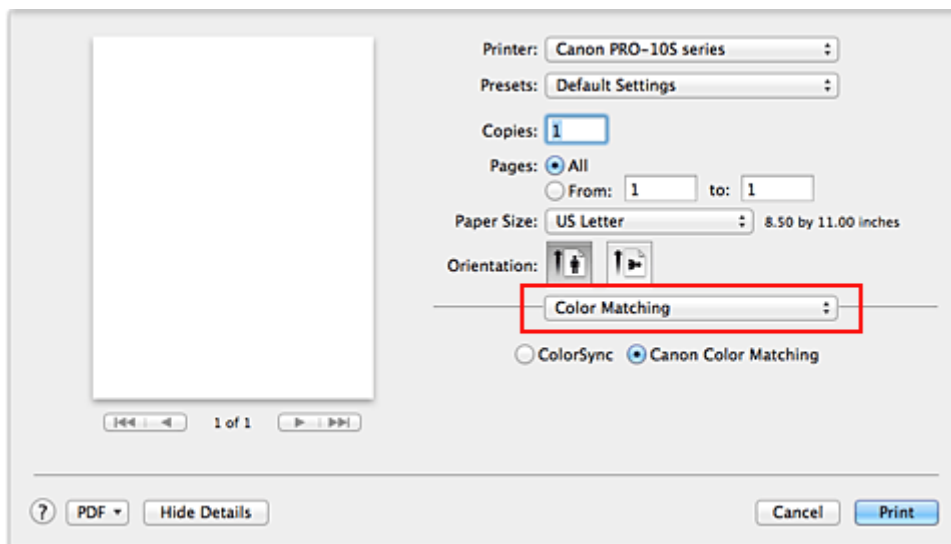

2. Select color correction

Select **Canon Color Matching**.

3. Set the other items

From the pop-up menu, select **Color Options**. If necessary, adjust the color balance (**Cyan**, **Magenta**, **Yellow**) and adjust **Brightness**, **Intensity**, and **Contrast** settings.

4. Complete the setup

Click **Print**.

When you execute print, the printer driver adjusts the colors when printing the data.

Related Topics

- [Setting the Print Quality Level \(Custom\)](#)
- [Specifying Color Correction](#)
- [Adjusting Color Balance](#)
- [Adjusting Brightness](#)
- [Adjusting Intensity](#)
- [Adjusting Contrast](#)

Printing with ICC Profiles (Specifying an ICC Profile from the Application Software)

When you print from Adobe Photoshop, Canon Digital Photo Professional, or any application software that can identify input ICC profiles and allows you to specify such profiles, printer uses the color management system (ColorSync) built-into Mac OS when printing. The printer prints the editing and touch-up results of the application software and effectively uses the color space of the input ICC profile specified in the image data.

To use this printing method, use your application software to select color management items and specify an input ICC profile and a printing ICC profile in the image data.

Even if you print using a printing ICC profile that you created yourself or one for special Canon paper, be sure to select color management items from your application software.

For instructions, refer to the manual of the application software you are using.

1. Select **Color Matching** from the pop-up menu of the [Print Dialog](#)

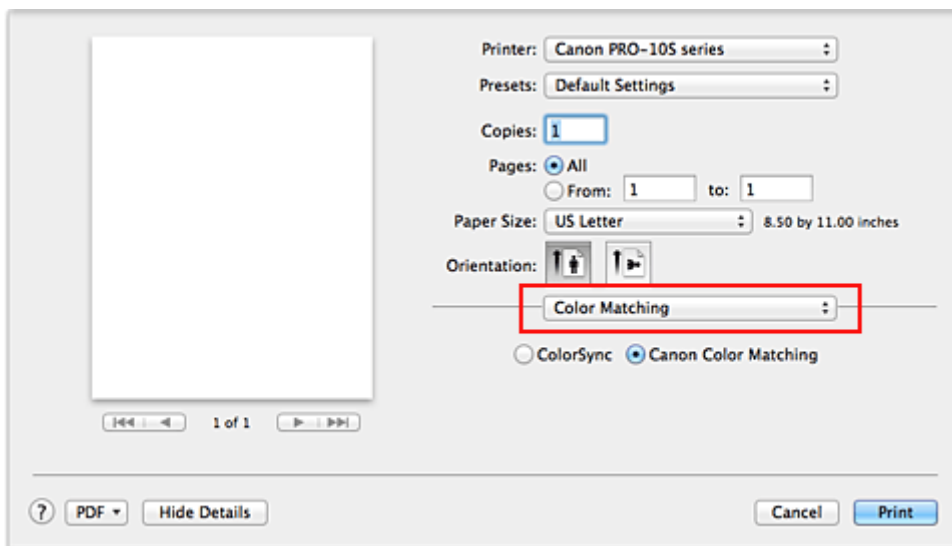

2. Select color correction

Select **ColorSync**.

You can leave **Profile** set to **Automatic**.

►►► Important

- Depending on the application software you use, you may not be able to select setting items other than **ColorSync**.
- If you choose a **Profile** setting other than **Automatic** or "Printing Paper ICC Profile", the printer will not be able to print with the correct colors.

3. Complete the setup

Click **Print**.

When you execute print, the printer uses the color space of the image data.

Related Topics

- [Setting the Print Quality Level \(Custom\)](#)
- [Specifying Color Correction](#)
- [Adjusting Color Balance](#)

- [Adjusting Brightness](#)
- [Adjusting Intensity](#)
- [Adjusting Contrast](#)

Printing with ICC Profiles (Specifying an ICC Profile from the Printer Driver)

Print from an application software that cannot identify or specify input ICC profiles by using the color space of the input ICC profile (sRGB) found in the data.

1. Select **Color Matching** from the pop-up menu of the [Print Dialog](#)

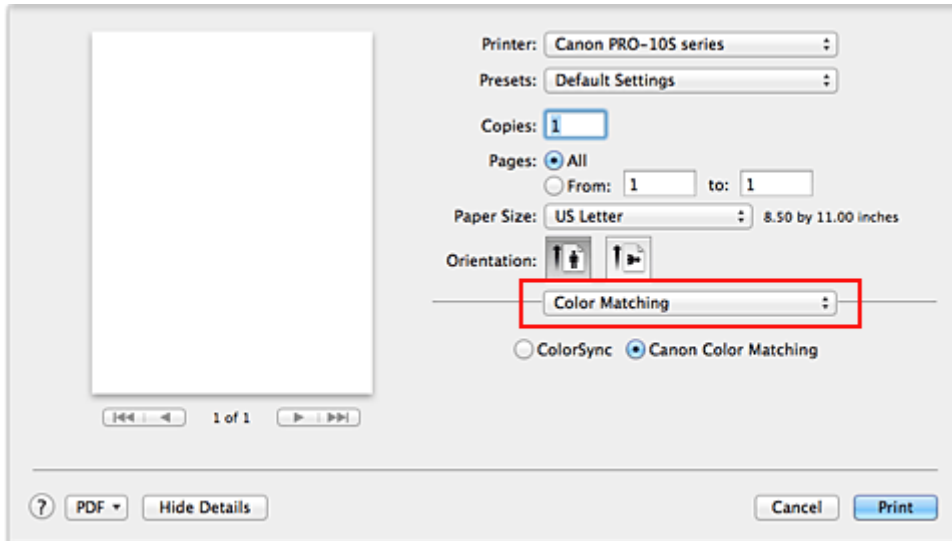

2. Select color correction

Select **ColorSync**.

You can leave **Profile** set to **Automatic**.

»» Important

- If you choose a **Profile** setting other than **Automatic** or "Printing Paper ICC Profile", the printer will not be able to print with the correct colors.

3. Complete the setup

Click **Print**.

When you execute print, the printer uses the color space of the image data.

»» Important

- You cannot specify an input ICC profile from the printer driver.

Related Topics

- [Setting the Print Quality Level \(Custom\)](#)
- [Specifying Color Correction](#)
- [Adjusting Color Balance](#)
- [Adjusting Brightness](#)
- [Adjusting Intensity](#)
- [Adjusting Contrast](#)

Interpreting the ICC Profile

When you need to specify an ICC profile for this printer, specify the ICC profile of the print output media.

The ICC profiles installed for this printer appear as follows.

Canon XXXXX <GL><PP> 1/2 Photo Paper Plus Glossy&Gold
(1) (2) (3)

- (1) is the model name of the printer.
- (2) is the print quality.
The print quality is divided into 5 levels, ranging from high speed to high quality. As the number decreases, the print quality becomes higher. This value corresponds to the **Quality** slide bar that is displayed when you select **Quality & Media** from the pop-up menu of the Print dialog and then select **Custom** for **Print Quality**.
- (3) is the media type. This media name corresponds to the following media type:
Photo Paper Plus Glossy&Gold: Photo Paper Plus Glossy II
Photo Paper Pro Platinum: Photo Paper Pro Platinum
Photo Paper Pro Luster: Photo Paper Pro Luster
Photo Paper Plus Semi-Gloss: Photo Paper Plus Semi-gloss
Matte Photo Paper: Matte Photo Paper
Other Glossy Paper: Other Glossy Paper (Wide Margins) and Other Glossy Paper
Fine Art Museum Etching: Fine Art Paper "Museum Etching"
Other Fine Art Paper 1: Other Fine Art Paper 1
Other Fine Art Paper 2: Other Fine Art Paper 2 and Canvas

Adjusting Color Balance

You can adjust the color tints when printing.

Since this function adjusts color balance of the output by changing the ink ratios of each color, it changes the total color balance of the document. Use the application software when you want to change the color balance significantly. Use the printer driver only when you want to adjust the color balance slightly.

The following sample shows the case when color balance is used to intensify cyan and to diminish yellow so that the overall colors are more uniform.



No adjustment Adjust color balance

The procedure for adjusting color balance is as follows:

1. Select **Color Options** from the pop-up menu of the [Print Dialog](#)
2. Adjust color balance

There are individual sliders for **Cyan**, **Magenta**, and **Yellow**. Each color becomes stronger when the corresponding slider is moved to the right, and becomes weaker when the corresponding slider is moved to the left. For example, when cyan becomes weaker, the color red becomes stronger.

You can also directly enter a value linked to the slider. Enter a value in the range from -50 to 50. The current settings are displayed in the settings preview on the left side of the printer driver.

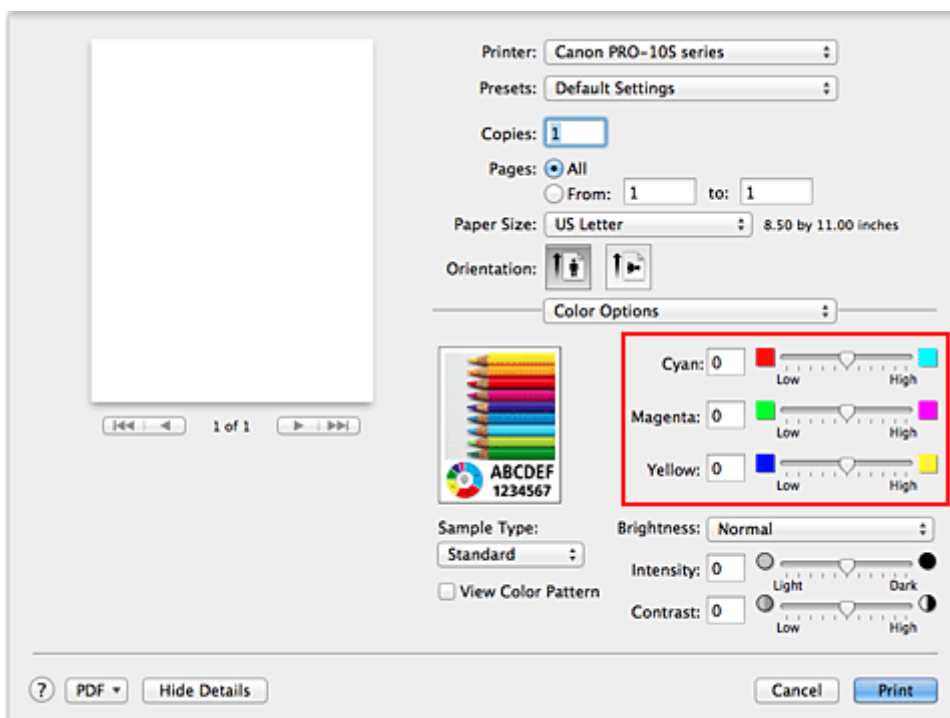

3. Complete the setup

Click **Print**.

When you execute print, the document is printed with the adjusted color balance.

»» Important

- When the **Black and White Photo Print** check box is checked for **Quality & Media**, the color balance (**Cyan, Magenta, Yellow**) are unavailable.
- If you select **ColorSync** for **Color Matching**, then the color balance (**Cyan, Magenta, Yellow**) appear grayed out and are unavailable.

Related Topics

- [Setting the Print Quality Level \(Custom\)](#)
- [Specifying Color Correction](#)
- [Adjusting Brightness](#)
- [Adjusting Intensity](#)
- [Adjusting Contrast](#)

Adjusting Brightness

You can change the brightness of the overall image data during printing.

This function does not change pure white or pure black but it changes the brightness of the intermediate colors.

The following sample shows the print result when the brightness setting is changed.



Light is selected

Normal is selected

Dark is selected

The procedure for adjusting brightness is as follows:

1. Select **Color Options** from the pop-up menu of the [Print Dialog](#)
2. Specify the brightness

Select **Light**, **Normal**, or **Dark** for **Brightness**. The current settings are displayed in the settings preview on the left side of the printer driver.

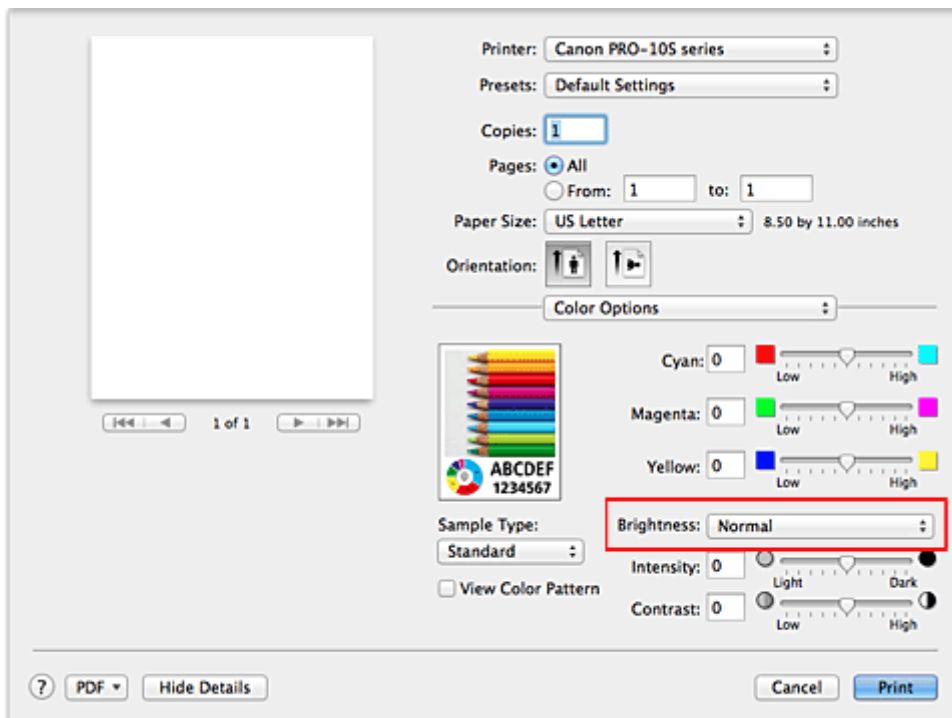

3. Complete the setup

Click **Print**.

When you execute print, the data is printed at the specified brightness.

Important

- If you select **ColorSync** for **Color Matching**, then the **Brightness** appears grayed out and is unavailable.

Related Topics

- [Setting the Print Quality Level \(Custom\)](#)
- [Specifying Color Correction](#)
- [Adjusting Color Balance](#)
- [Adjusting Intensity](#)
- [Adjusting Contrast](#)

Adjusting Intensity

You can dilute (brighten) or intensify (darken) the colors of the overall image data during printing. The following sample shows the case when the intensity is increased so that all colors become more intense when the image data is printed.



No adjustment

Higher intensity

The procedure for adjusting intensity is as follows:

1. Select **Color Options** from the pop-up menu of the [Print Dialog](#)
2. Adjust intensity

Moving the **Intensity** slider to the right intensifies (darkens) the colors, and moving the slider to the left dilutes (brightens) the colors.

You can also directly enter a value linked to the slider. Enter a value in the range from -50 to 50. The current settings are displayed in the settings preview on the left side of the printer driver.

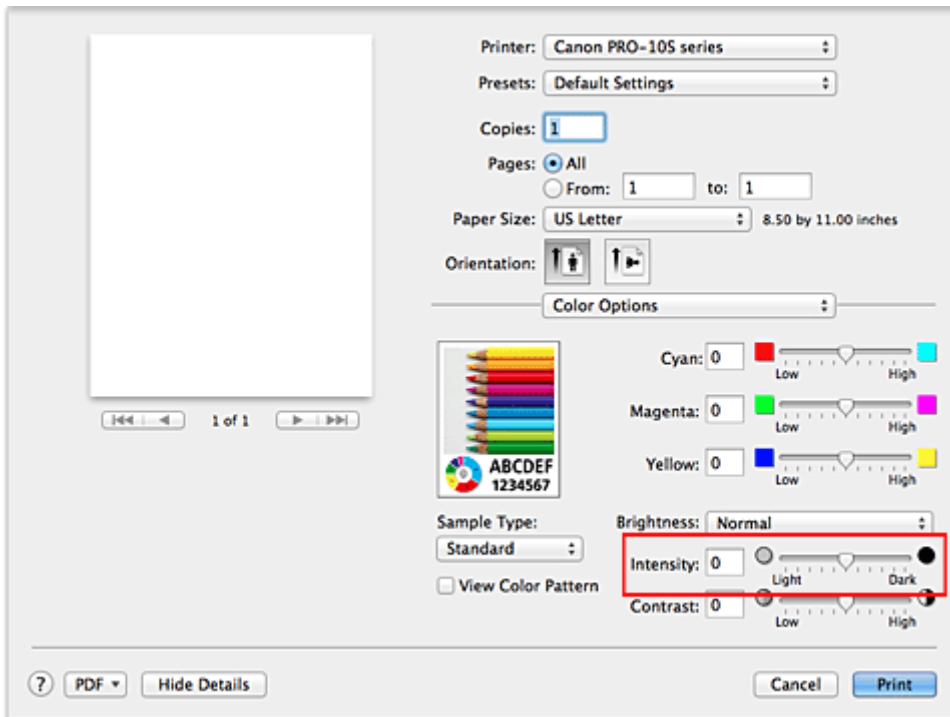

3. Complete the setup

Click **Print**.

When you execute print, the image data is printed with the adjusted intensity.

Important

- If you select **ColorSync** for **Color Matching**, then the **Intensity** appears grayed out and is unavailable.

Related Topics

- [Setting the Print Quality Level \(Custom\)](#)
- [Specifying Color Correction](#)
- [Adjusting Color Balance](#)
- [Adjusting Brightness](#)
- [Adjusting Contrast](#)

Adjusting Contrast

You can adjust the image contrast during printing.

To make the differences between the light and dark portions of images greater and more distinct, increase the contrast. On the other hand, to make the differences between the light and dark portions of images smaller and less distinct, reduce the contrast.



No adjustment

Adjust the contrast

The procedure for adjusting contrast is as follows:

1. Select **Color Options** from the pop-up menu of the [Print Dialog](#)
2. Adjust the contrast

Moving the **Contrast** slider to the right increases the contrast, and moving the slider to the left decreases the contrast.

You can also directly enter a value linked to the slider. Enter a value in the range from -50 to 50. The current settings are displayed in the settings preview on the left side of the printer driver.

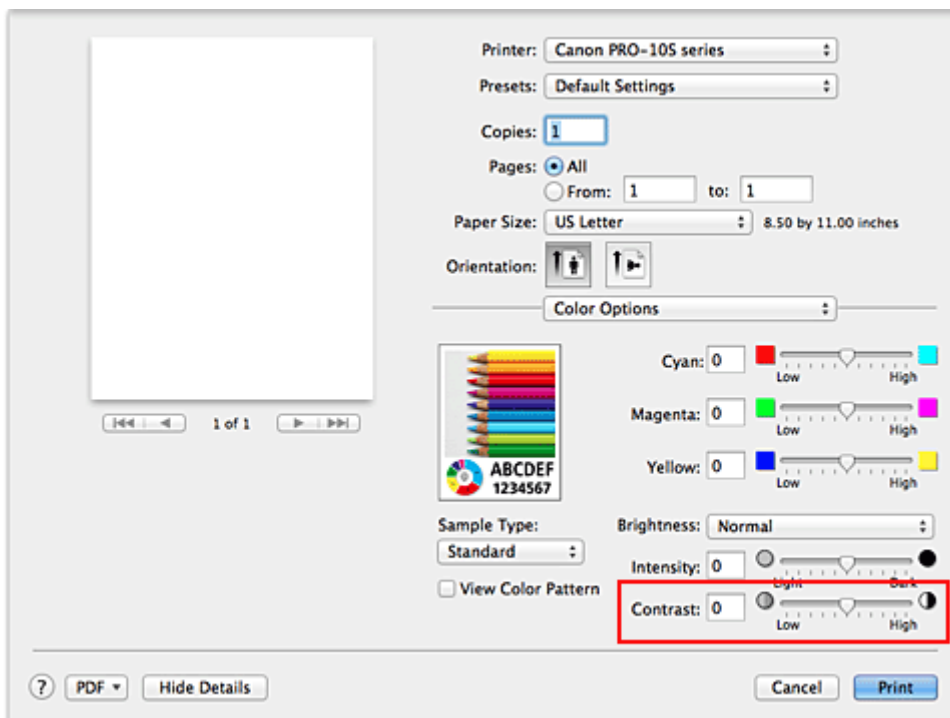

3. Complete the setup

Click **Print**.

When you execute print, the image is printed with the adjusted contrast.

▶▶ Important

- If you select **ColorSync** for **Color Matching**, then the **Contrast** appears grayed out and is unavailable.

Related Topics

- [Setting the Print Quality Level \(Custom\)](#)
- [Specifying Color Correction](#)
- [Adjusting Color Balance](#)
- [Adjusting Brightness](#)
- [Adjusting Intensity](#)

Overview of the Printer Driver

- ▶ **Canon IJ Printer Driver**
- ▶ **How to Open the Printer Driver Setup Window**
- ▶ **Page Setup Dialog**
- ▶ **Print Dialog**
- ▶ **Quality & Media**
- ▶ **Color Options**
- ▶ **Clear Coating**
- ▶ **Borderless Printing**
- ▶ **Margin**
- ▶ **Canon IJ Printer Utility**
- ▶ **Opening the Canon IJ Printer Utility**
- ▶ **Maintenance of this Printer**
- ▶ **Display the Printing Status Screen**
- ▶ **Deleting the Undesired Print Job**
- ▶ **Instructions for Use (Printer Driver)**

Canon IJ Printer Driver

The Canon IJ printer driver (called printer driver below) is a software that is installed on your computer for printing data with this printer.

The printer driver converts the print data created by your application software into data that your printer can understand, and sends the converted data to the printer.

Because different models support different print data formats, you need a printer driver for the specific model you are using.

Using Help of the Printer Driver

You can display Help function from the [Print Dialog](#).

Select a setup item from the pop-up menu in the Print dialog. Then click  at the bottom left of the screen to display an explanation of the item.

Help for the printer driver is displayed when the following pop-up menu item is selected:

- **Quality & Media**
- **Color Options**
- **Clear Coating**
- **Borderless Printing**
- **Margin**

How to Open the Printer Driver Setup Window

You can display the printer driver setup window from the application software you are using.

Opening the Page Setup Dialog

Use this procedure to set the page (paper) settings before printing.

1. Select **Page Setup...** from the **File** menu of the application software

The [Page Setup Dialog](#) opens.

Opening the Print Dialog

Use this procedure to set the print settings before printing.

1. Select **Print...** from the **File** menu of the application software

The [Print Dialog](#) opens.

Page Setup Dialog

In the Page Setup dialog, you configure the basic print settings such as the size of paper loaded in the printer or the scaling ratio.

To open the Page Setup dialog, you typically select **Page Setup...** from the **File** menu of your application software.

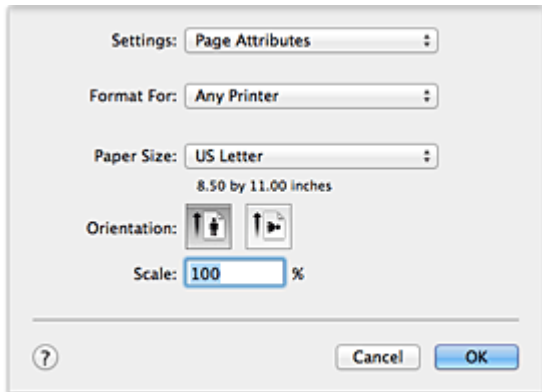

Settings

Click the pop-up menu, and then select the following items:

Page Attributes

Set the paper size or scaled printing.

Save as Default

You can save the attributes of the displayed page as the default settings.

Format For

Select the model to be used for printing.

Paper Size

Select the size of the paper to be used for printing.

To set a non-standard size, select **Manage Custom Sizes...**

Orientation

Select the print orientation.

Scale

Set the scaling percentage.

You can expand or reduce the size of the document when printing.

Print Dialog

In the Print dialog, you can set paper type, paper source and print quality to start printing.

To open the Print dialog, you typically select **Print...** from the **File** menu of your application software.

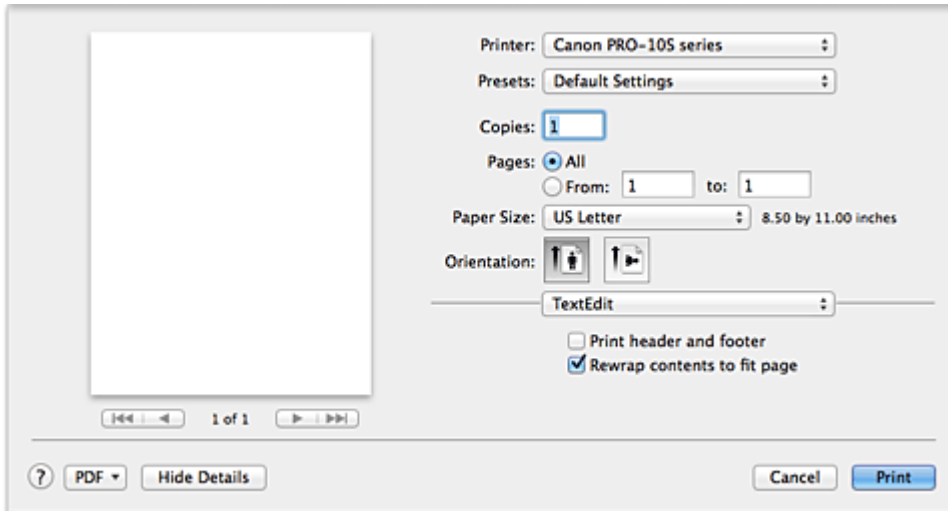

Printer

Select the model to be used for printing.

When you click **Add Printer...**, a dialog for specifying the printer opens.

Presets

You can save or delete the settings of the Print dialog.

»» Note

- You can select **Show Presets...** to check the print settings that are set in the Print dialog.

Copies

You can set the number of copies to be printed.

»» Note

- You can set collated printing by choosing **Paper Handling** from the pop-up menu.

Pages

You can set the range of pages to be printed.

Paper Size

Select the size of the paper to be used for printing.

To set a non-standard size, select **Manage Custom Sizes...**

Orientation

Select the print orientation.

Pop-up Menu

You can switch between pages in the Print dialog by the pop-up menu. The first menu to appear differs depending on the application software that opened the Print dialog.

You can choose one of the following items from the pop-up menu.

Layout

You can set page layout printing.

Use **Reverse page orientation** to change the paper orientation, and use **Flip horizontally** to print a mirror image of the document.

Color Matching

You can select the color correction method.

Paper Handling

You can set the pages to be printed on paper and the print order.

Cover Page

You can output cover pages both before and after a document.

Quality & Media

You can set basic print settings that match the printer.

Color Options

You can adjust the print colors as you desire.

Clear Coating

You can set the various Clear Coating functions.

Borderless Printing

You can adjust the amount of document that extends off the paper when performing borderless printing.

Margin

You can set the stapling side and the stapling margin.

Supply Levels

A rough indication of the remaining ink level is displayed.

PDF

You can save a document in PDF (Portable Document Format) format.

Quality & Media

This dialog allows you to create a basic print setup in accordance with the paper type. Unless special printing is required, normal printing can be performed just by setting the items in this dialog.

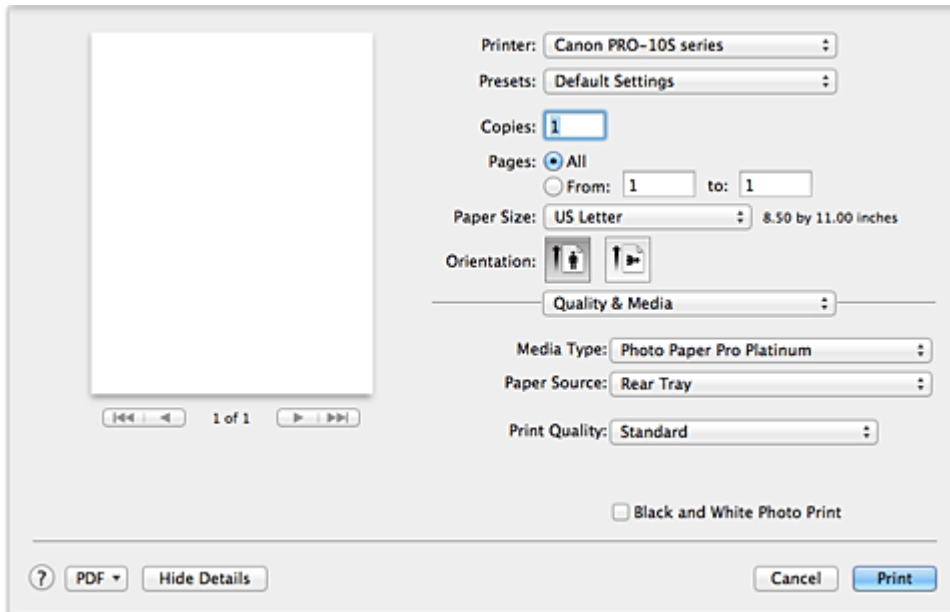

Media Type

Select the type of media to be used.

You must select the type of media actually loaded in the printer. This selection enables the printer to carry out printing properly for the material of the media used.

Paper Source

Select the source from which paper is supplied.

Manual Feed

Paper is supplied from the manual feed tray in the back.

Rear Tray

Paper is fed from the rear tray.

Print Quality

Select the one that is closest to the original document type and the purpose.

When one of the radio buttons is selected, the appropriate quality will be set automatically.

High

Gives priority to print quality over printing speed.

Standard

Prints with average speed and quality.

Fast

Gives priority to printing speed over print quality.

Custom

Select this radio button to specify a quality.

Quality

When you select **Custom** in **Print Quality**, you can use the slider bar to adjust the print quality level.

Black and White Photo Print

Set black and white photo printing. Black and white photo printing refers to the function of converting your document to grayscale data in the printer to print it in monochrome.

When you check the check box, both monochrome and color documents will be printed in monochrome.
When printing a color document, be sure to uncheck the check box.

Related Topics

- [Switching the Paper Source to Match the Purpose](#)
- [Setting the Print Quality Level \(Custom\)](#)
- [Printing a Color Document in Monochrome](#)

Color Options

This dialog allows you to adjust the print color as you like. If the color of the printed image is not as expected, adjust the properties in the dialog and retry printing.

The adjustments made here do not affect the colors of the original print data unlike application software dedicated to image processing. Use this dialog just to make fine adjustments.

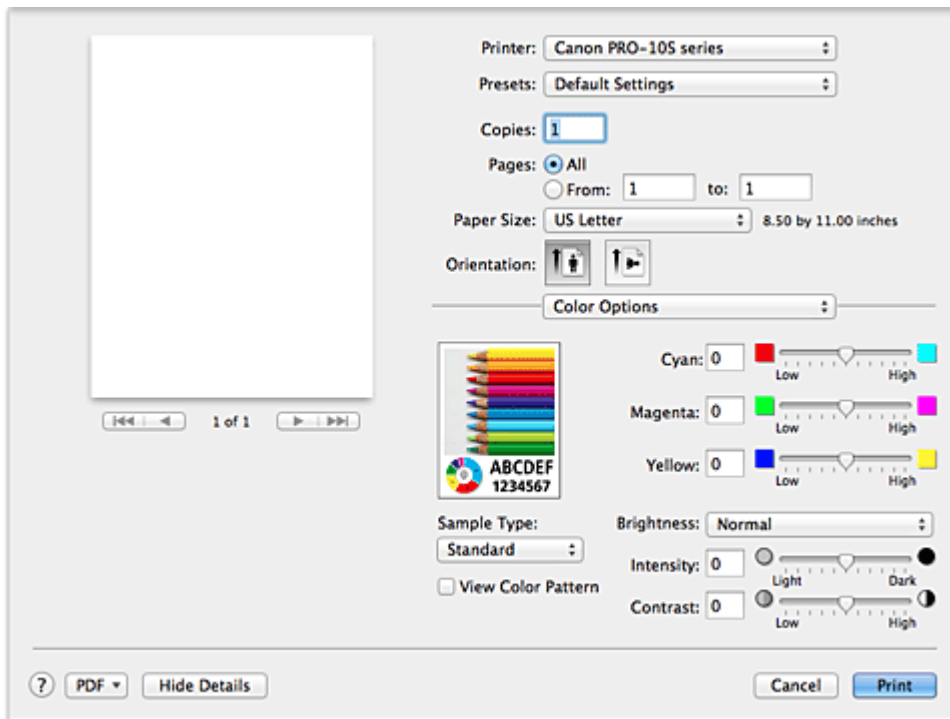

Preview

Shows the effect of color adjustment.

As you adjust each item, the effects are reflected in the color and brightness.

Sample Type

Select an image that you want to display as a sample.

If necessary, select one from **Standard**, **Landscape**, or **Graphics**, whichever is most similar to the print results.

View Color Pattern

Displays a pattern for checking color changes produced by color adjustment.

When you want to display the sample image with a color pattern, check this check box.

When you want to display the sample image with one that you selected with **Sample Type**, uncheck this check box.

►►► Note

- When the **Black and White Photo Print** check box is checked in the **Quality & Media**, the graphic is displayed in monochrome.

Color balance (Cyan, Magenta, Yellow)

If necessary, adjust the strength of each color. To strengthen a color, drag the slider to the right. To weaken a color, drag the slider to the left.

You can also directly enter a value linked to the slider. Enter a value in the range from -50 to 50.

Adjusting the color balance will result in variations in the balance among the volumes of the individual color inks and hence in the hues of the document as a whole.

Use the printer driver only when adjusting the color balance slightly. To change the color balance significantly, use the application software.

Tone

Sets the color adjustment for monochrome printing.

You can select **Cool Tone**, **Black and White**, **Warm Tone** or **Custom**.

You can also enter **X** and **Y** values while checking the color tone, click the adjustment area with the mouse, or adjust the tone by dragging the slider.

►► Important

- **Tone** and **X, Y** (Monochromatic adjustment value) are displayed when **Black and White Photo Print** check box is selected for **Quality & Media**.

Brightness

Select the brightness of printed images.

You cannot change the levels of pure white and black. You can change the contrast of the colors between white and black.

Intensity

Select this method to adjust the overall density of your print.

To increase the overall intensity, drag the slider to the right. To decrease the overall intensity, drag the slider to the left.

You can also directly enter a value linked to the slider. Enter a value in the range from -50 to 50.

Contrast

The Contrast function changes the differences between light and dark in images during printing.

To make the differences between the light and dark portions of images greater and more distinct, increase the contrast. On the other hand, to make the differences between the light and dark portions of images smaller and less distinct, reduce the contrast.

You can also directly enter a value linked to the slider. Enter a value in the range from -50 to 50.

►► Important

- When the **Black and White Photo Print** check box is checked for **Quality & Media**, the color balance (**Cyan, Magenta, Yellow**) are unavailable.
- If you select **ColorSync** for **Color Matching**, then the color balance (**Cyan, Magenta, Yellow**), **Tone, X, Y, Brightness, Intensity**, and **Contrast** appear grayed out and are unavailable.

Related Topics

- [Specifying Color Correction](#)
- [Adjusting Color Balance](#)
- [Adjusting Brightness](#)
- [Adjusting Intensity](#)
- [Adjusting Contrast](#)

Clear Coating

This dialog allows you to set the various Clear Coating functions.

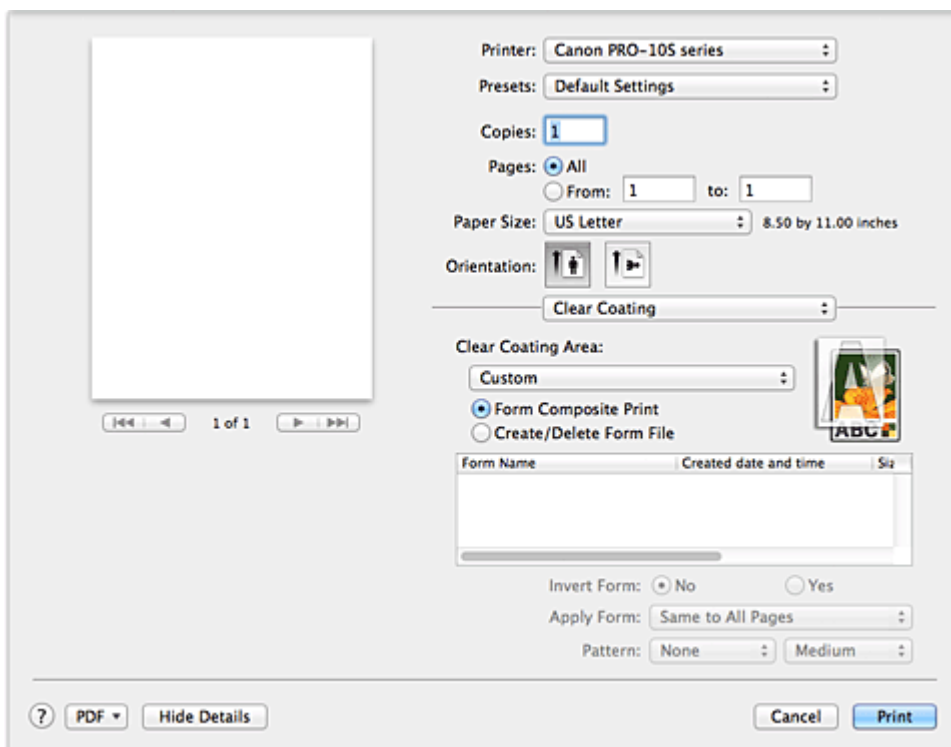

Clear Coating Area

Set the clear coating area.

Auto

The printer automatically sets the areas to be clear-coated and whether clear coating is to be executed.

It may be possible to reduce the ink consumption of the chroma optimizer (CO) or to accelerate the print speed.

Overall

The printer clear-coats the entire print area.

If selecting **Auto** produced unsatisfactory clear coating effects, selecting **Overall** may improve the results.

Custom

Use a form to specify the clear coating areas.

Select this option also when you are creating or deleting a form.

Form Composite Print

Select this item to combine forms and patterns that specify clear coating areas and to print the document by adding decorative effects.

Note that you must first create a form file to execute form composite print.

Create/Delete Form File

Select this item to create or delete a form file to be used in form composite print.

►►► Important

- On the **Quality & Media**, look at **Media Type**. If a media type other than **Photo Paper Plus Glossy II**, **Photo Paper Pro Platinum**, **Photo Paper Pro Luster**, **Photo Paper Plus Semi-gloss**, **Other Glossy Paper (Wide Margins)**, or **Other Glossy Paper** is selected, you cannot select **Overall** or **Custom**.

- Depending on which print quality is set on the **Quality & Media**, you may not be able to select **Custom**.
- If **Overall** is selected and the media type is changed to one that cannot use **Overall**, the clear coating area setting is changed to **Auto**.
- If **Custom** is selected and the media type or the print quality is changed to one that does not support form composite print or form file creation, the clear coating area setting is changed to **Auto**.

Form Files

This function displays a list of the saved form files.

Form Name

Displays the form name.

Created date and time

Displays the form file creation date and time.

Size

Displays the paper size of the form.

Pages

Display the number of pages in the form.

Borderless (Extension)

Displays the borderless print setting of the form. When the borderless print setting is enabled, the extension amount is also displayed.

Invert Form

Selecting **Form Composite Print** allows you to reverse the clear coating areas specified in the form.

No

The printer prints the data without reversing the clear coating areas.

Yes

The printer reverses the clear coating areas and prints the data.

Apply Form

Select the method for applying the form to the document pages, when **Form Composite Print** is selected.

Same to All Pages

The first page of the selected form is applied to all pages of the document.

Individual Page

If the page count of the form file is 2 or more, the printer matches the document and form pages in sequence from the first page during printing.

If the document page count is larger than the form page count, the printer applies the **Overall** function of **Clear Coating Area** to the remaining pages.

When multiple copies are printed, the number of copies that was set for the document must also be set for the applicable form during form file creation.

Pattern

Select the pattern type and size, when **Form Composite Print** is selected.

The pattern is applied to areas that are not clear coated.

Delete

Deletes the form file that you selected in form files.

If the print queue contains a form composite print job, do not delete the form specified by that job.

Form Name

Enter the name of the form to be created.

Related Topics

- [Changing the Clear Coating Settings](#)
- [Create or Delete a Form File](#)

Borderless Printing

This dialog allows you to adjust the amount of the document that extends off the paper when borderless printing is performed.

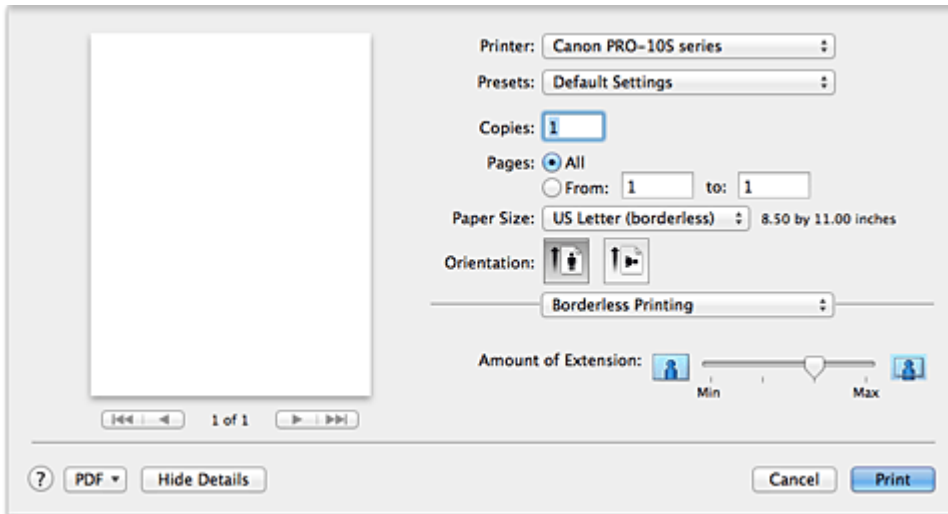

Amount of Extension

Use the **Amount of Extension** slider to adjust the amount of the document that extends off the paper. Moving the slider to the right makes the amount larger and moving the slider to the left makes the amount smaller.

Related Topic

- [Execute Borderless Printing](#)

Margin

This dialog allows you to set the stapling side and amount of margin for stapling multiple sheets of paper.

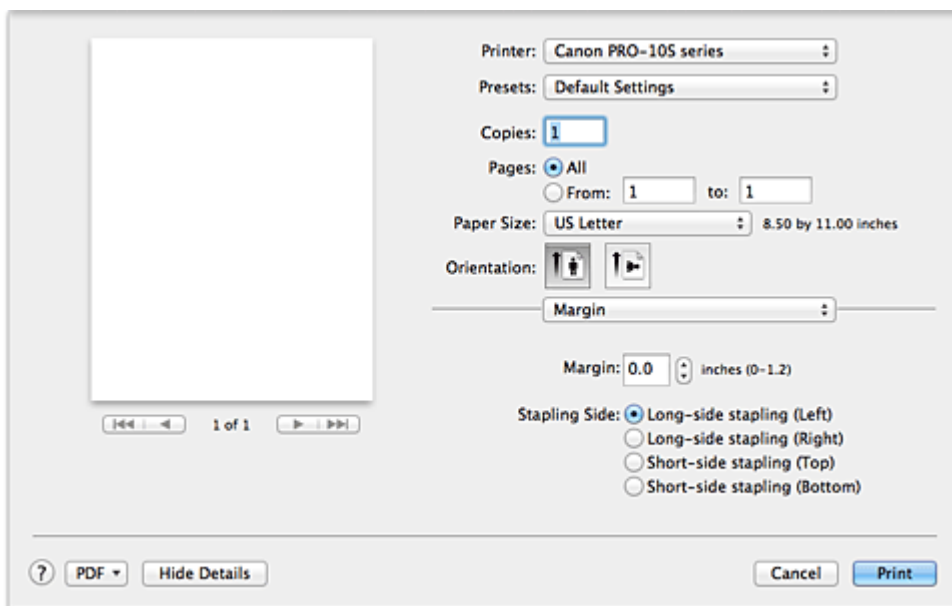

Margin

Specify the amount of margin space for stapling the paper. Enter a value between 0 inch (0 mm) to 1.2 inches (30 mm).

Stapling Side

Specify the stapling side.

Long-side stapling (Left) / Long-side stapling (Right)

Select this option to staple the long side of the paper.

Choose left or right.

Short-side stapling (Top) / Short-side stapling (Bottom)

Select this option to staple the short side of the paper.

Choose top or bottom.

Related Topic

- [Setting the Stapling Margin](#)

Canon IJ Printer Utility

The Canon IJ Printer Utility allows you to perform printer maintenance or change the settings of the printer.

What You Can Do with the Canon IJ Printer Utility

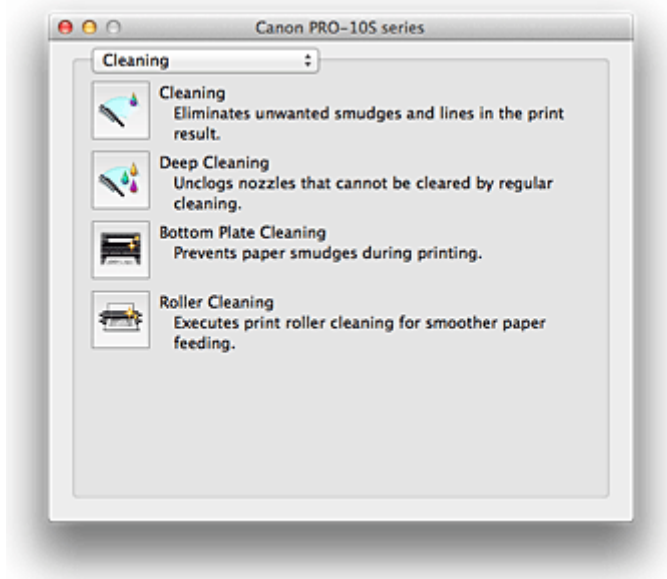

You can switch between pages in Canon IJ Printer Utility by the pop-up menu. You can choose one of the following items from the pop-up menu.

Cleaning

Clean the printer to prevent print smudges and clear up clogged print head nozzle.

Test Print

Execute a test print to check the condition of the print head nozzle and to adjust the print head position.

Power Settings

Operate the power of this printer from the printer driver.

Ink Level Information

Check the remaining ink levels.

Quiet Settings

You can reduce the operating noise of the printer.

Custom Settings

Change the settings of this printer.

►►► Note

- To operate the Canon IJ Printer Utility, you must first turn on the printer.
- Depending on the items selected, the computer communicates with the printer to obtain information. If the computer is unable to communicate with the printer, an error message may be displayed. If this happens, click **Cancel** to display the most recent settings specified on your computer.

Related Topics

- [Cleaning the Print Heads from Your Computer](#)
- [Cleaning Inside the Printer](#)
- [Cleaning the Paper Feed Rollers from Your Computer](#)

- [Use Your Computer to Print a Nozzle Check Pattern](#)
- [Aligning the Print Head Position from Your Computer](#)
- [Maintaining the Ink Quality](#)
- [Checking the Ink Status from Your Computer](#)
- [Managing the Printer Power](#)
- [Reducing the Printer Noise](#)
- [Changing the Printer Operation Mode](#)

Opening the Canon IJ Printer Utility

To open the Canon IJ Printer Utility, follow the steps below.

1. Open **System Preferences**, and select **Printers & Scanners (Print & Scan)**

2. Start the Canon IJ Printer Utility

Select your model from the printer list, and click **Options & Supplies...**

Click **Open Printer Utility** in **Utility** tab.

Canon IJ Printer Utility is launched.

Maintenance of this Printer

- **Cleaning the Print Heads from Your Computer**
- **Cleaning Inside the Printer**
- **Cleaning the Paper Feed Rollers from Your Computer**
- **Use Your Computer to Print a Nozzle Check Pattern**
- **Aligning the Print Head Position from Your Computer**
- **Maintaining the Ink Quality**
- **Checking the Ink Status from Your Computer**
- **Managing the Printer Power**
- **Reducing the Printer Noise**
- **Changing the Printer Operation Mode**

Display the Printing Status Screen

Check the print progress according to the following procedure:

1. Launch the printing status screen

- If the print data has been sent to the printer

The printing status screen opens automatically. To display the printing status screen, click the  (the printer icon) displayed on the Dock.

- If the print data has not been sent to the printer

Open **System Preferences**, and select **Printers & Scanners (Print & Scan)**.





To display the printing status screen, select the name of your printer model from the printer list, and then click **Open Print Queue....**

2. Checking the printing status

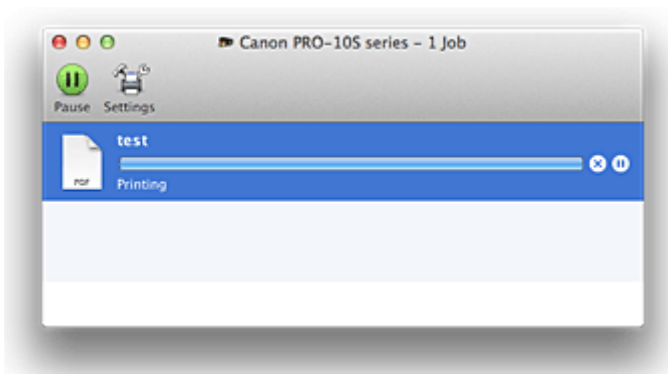
You can check the name of the file being printed or ready for being printed.







- If you are using OS X Mavericks v10.9 or OS X Mountain Lion v10.8

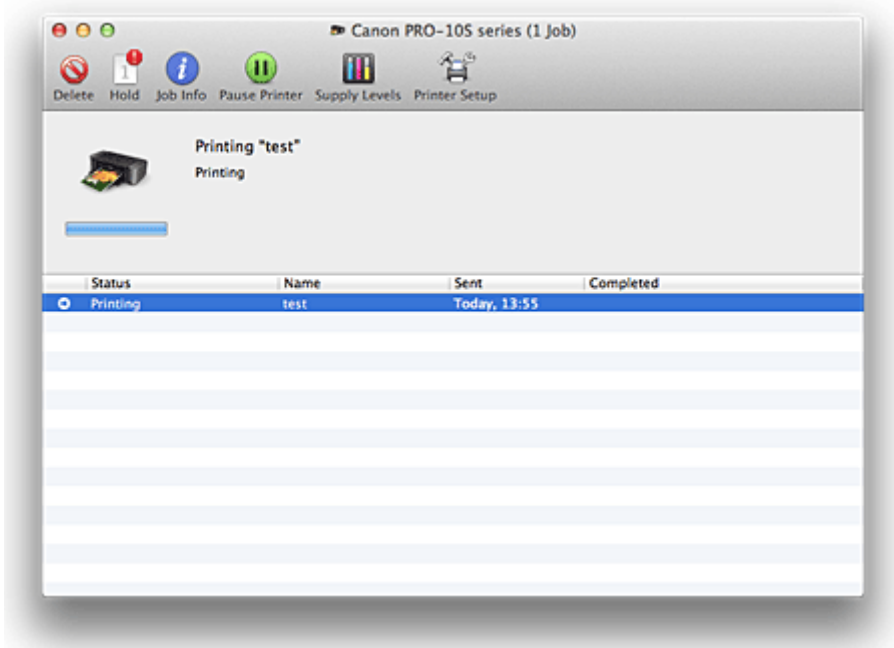

-  Deletes the specified print job.
-  Stops printing the specified document.
-  Resumes printing the specified document.
-  Stops printing all documents.
-  Displayed only when printing of all documents is being stopped, and resumes printing all documents.

- If you are using OS X Lion v10.7



-  Deletes the specified print job.
-  Stops printing the specified document.
-  Resumes printing the specified document.
-  Displays the print job information.
-  Stops printing all documents.
-  Displayed only when printing of all documents is being stopped, and resumes printing all documents.

Deleting the Undesired Print Job

If the printer does not start printing, canceled or failed print job data may be remaining. Delete unnecessary print jobs from the print status check screen.

1. Open **System Preferences**, and select **Printers & Scanners (Print & Scan)**

2. Select your model, and then click **Open Print Queue...**

The print status check screen appears.

3. Select the unnecessary print job and click  ( **Delete**)

The selected print jobs will be deleted.

Instructions for Use (Printer Driver)

This printer driver is subject to the following restrictions. Keep the following points in mind when using the printer driver.

Restrictions on the Printer Driver

- When you set up the Page Setup dialog, be sure to begin by selecting the model you are using from the **Format For** list. If you select another printer, printing may not be performed properly.
- If the Canon IJ Printer Utility does not display the remaining ink level in the **Ink Level Information**, check whether the print head and the ink tank are properly installed.
- When the Canon IJ Printer Utility displays the **Ink Level Information**, close the top cover of the printer.
- The following functions cannot be used in Mac OS, though they can be used in Windows computers.
 - Duplex Printing
 - Booklet Printing
 - Tiling/Poster Printing
- Depending on the application software that you are using, a preview may not be displayed on the left side of the Print dialog.
- Do not start up the Canon IJ Network Tool while printing.
- Do not print when the Canon IJ Network Tool is running.
- If you connect this printer and AirPort with a USB cable and print, you must install the latest AirPort firmware.
- If you are using OS X Mavericks v10.9, close the print status check window when you perform printer maintenance from the Canon IJ Printer Utility.

Notes on Adding a Printer

- If you will be installing the Canon printer driver on Mac OS and using the printer through a network connection, you can select **Bonjour** or **Canon IJ Network** in the **Add (Add Printer)** dialog. Canon recommends you to use **Canon IJ Network** for printing. If **Bonjour** is selected, remaining ink level messages may differ from those indicated by **Canon IJ Network**.

Points to Note About Applications with Restrictions

- When you create a new document with Microsoft Word 2004 for Mac, a paper size other than A4 size or Letter size may be set. Check the **Paper Size** on the Print dialog.

Updating the Printer Driver

- **Obtaining the Latest Printer Driver**
- **Delete the Unnecessary Canon IJ Printer from the Printer List**
- **Before Installing the Printer Driver**
- **Installing the Printer Driver**

Obtaining the Latest Printer Driver

By updating the printer driver to the latest version of the printer driver, unresolved problems may be solved.

You can access our website and download the latest printer driver for your model.

Important

- You can download the printer driver for free, but any Internet access charges incurred are your responsibility.

Related Topics

- [Before Installing the Printer Driver](#)
- [Installing the Printer Driver](#)

Delete the Unnecessary Canon IJ Printer from the Printer List

A Canon IJ Printer that you no longer use can be deleted from the printer list.

Before deleting the Canon IJ Printer, disconnect the cable that connects the printer to the computer.

The procedure to delete the unnecessary Canon IJ Printer from the printer list is as follows:

You cannot delete the Canon IJ Printer unless you are logged in as a user with the administrative right. For information about an administrative user, refer to the user's manual for the Mac OS.

1. Open **System Preferences**, and select **Printers & Scanners (Print & Scan)**
2. Delete the Canon IJ Printer from the printer list

From the printer list, select the Canon IJ Printer to be deleted, and then click -.

Click **Delete Printer** when the confirmation message appears.

Note

- Even if a Canon IJ Printer is deleted from the printer list, you can re-register it automatically by connecting the printer and your computer with a USB cable.

Before Installing the Printer Driver

This section describes the items that you should check before installing the printer driver. You should also refer to this section if the printer driver cannot be installed.

Checking the Personal Computer Settings

- Terminate all running applications.
- Log on as a user who has the administrator account. The installer will prompt you to enter the name and password of the administrative user. When multiple users are using Mac OS, log on with the account of the administrator who registered first.

»» Important

- When you upgrade Mac OS, all printer drivers that were installed will be deleted. If you plan to continue using this printer, re-install the latest printer driver.

Related Topics

- [Obtaining the Latest Printer Driver](#)
- [Installing the Printer Driver](#)

Installing the Printer Driver

You can access our web site through the Internet and download the latest printer driver for your model.

The procedure for installing the downloaded printer driver is as follows:

1. Mount the disk

Double-click the disk image file you have downloaded.
The file is unpacked, and then the disk is mounted.

2. Start the installer

Double-click "PrinterDriver_XXX_YYY.pkg" (where "XXX" is your model name, and "YYY" is version) contained in the disk.

3. Start the installation

Install the printer driver according to the messages on the screen.

When the Software License Agreement is displayed, check the contents, and click **Continue**. If you do not agree to the terms of the Software License Agreement, you cannot install this software.

4. Selecting the install destination

If necessary, select where you want to install the printer driver, and then click **Continue**.

5. Executing the installation

Click **Install**.

When the authentication screen is displayed, enter the name and password of the administrator, and then click **Install Software**.

6. Complete the installation

When the completion message appears, click **Close**.

The printer driver is installed successfully.

Important

- If the Installer does not operate properly, select **Quit Installer** from the **Installer** menu of the Finder to quit the Installer. Then start the Installer again.
- You can download the printer driver for free, but you are responsible for paying any connection fees to the Internet.

Related Topics

- [Obtaining the Latest Printer Driver](#)
- [Delete the Unnecessary Canon IJ Printer from the Printer List](#)
- [Before Installing the Printer Driver](#)

Printing from a Digital Camera

- ▶ **[Printing Photographs Directly from a PictBridge Compliant Device](#)**
- ▶ **[About PictBridge Print Settings](#)**

Printing Photographs Directly from a PictBridge Compliant Device

You can connect a PictBridge compliant device such as a digital camera, camcorder, or mobile phone to the printer using a USB cable recommended by the device's manufacturer, and print recorded images directly without using a computer.

Connectable devices:

Any PictBridge compliant device can be connected to the printer regardless of the manufacturer or model as long as it is compliant with the PictBridge Standard.

Printable image data format:

The printer accepts images* taken with a camera compliant with the Design rule for Camera File system.

* Exif 2.2/2.21/2.3 compliant

►►► Important

- Do not use the USB cable longer than around 10 ft. / 3 m to connect any PictBridge compliant device to the printer since it may affect the operation of other peripheral devices.

►►► Note

- PictBridge is the Standard to print your photos directly without using a computer, connecting a device such as a digital still camera, digital camcorder, or camera-equipped mobile phone.



(PictBridge): A PictBridge compliant device has this mark.

- When printing photos with the PictBridge compliant device connected to the printer, we recommend the use of the AC adapter supplied with the device. If you are using the device battery, be sure to charge it fully.
- Depending on the model or brand of your device, you may have to select a print mode compliant with PictBridge before connecting the device. You may also have to turn on the device or select Play mode manually after connecting the device to the printer.

Perform necessary operations on the PictBridge compliant device before connecting it to this printer according to instructions given in the device's instruction manual.

1. [Make sure that the printer is turned on.](#)
2. [Load paper.](#)
3. Make sure that the PictBridge compliant device is turned off.
4. Connect the PictBridge compliant device to the printer using a USB cable (A) recommended by the device's manufacturer.

The PictBridge compliant device turns on automatically.

If your device does not turn on automatically, turn it on manually.

When printer is correctly connected to the device, the message that the printer is connected will be displayed on the LCD of the device. Refer to the device's instruction manual.

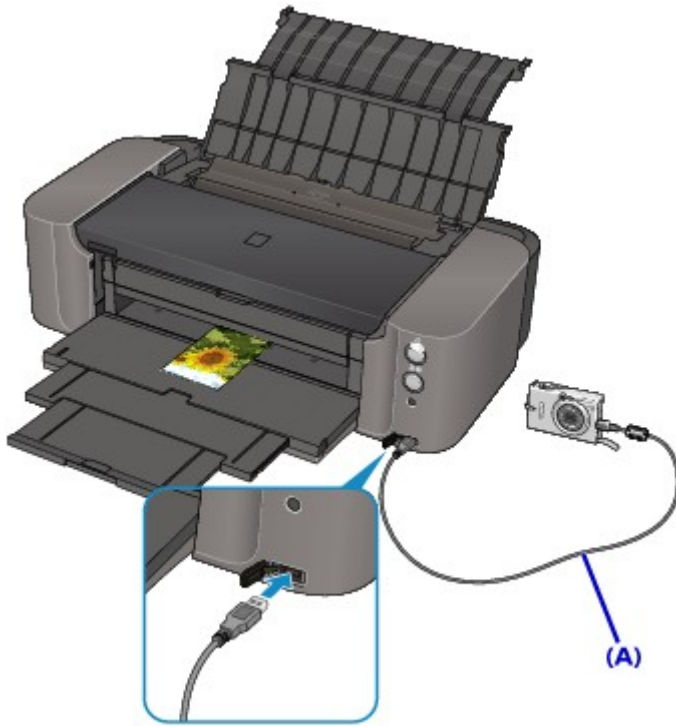

5. Specify the print settings such as the paper type and layout.

You can perform settings using the menu on the LCD of your PictBridge compliant device. Select the size and type of paper that you loaded in the printer.

■ [Settings on a PictBridge Compliant Device](#)

6. Start printing from your PictBridge compliant device.

▶▶▶ **Important**

- Never disconnect the USB cable during printing unless when explicitly allowed to by the PictBridge compliant device. When disconnecting the USB cable between the PictBridge compliant device and printer, follow the instructions given in the device's instruction manual.

About PictBridge Print Settings

Settings on a PictBridge Compliant Device

This section describes the PictBridge function of the printer. For the print settings on a PictBridge compliant device, refer to the instructions given in the device's instruction manual.

►► Note

- In the following description, names of setting items are given according to those used in Canon-brand PictBridge compliant devices. Setting item names may be different depending on the brand or model of your device.
- Some setting items explained below may not be available on some devices. When you cannot change print settings on a device, the printer prints images as follows:

Paper size: 4" x 6"/ 10 x 15 cm

Paper type: Fast Photo

Layout: 1-up, Borderless

Date/File No. Print: Not printed

The following settings can be used when printing from a PictBridge compliant device.

Paper size	4" x 6"/ 10 x 15 cm, 5" x 7"*, 8" x 10"/ 20 x 25 cm, A4, 8.5" x 11"(Letter), A3, A3+/ 13" x 19" * Can be selected only on certain Canon-brand PictBridge compliant devices. (May not be selected depending on the device.)
Paper type	<ul style="list-style-type: none"> • Default: Photo Paper Pro Platinum PT-101 • Photo: Photo Paper Plus Glossy II PP-201 • Semi-gloss*: Photo Paper Plus Semi-gloss SG-201/Photo Paper Pro Luster LU-101 • Fast Photo: Photo Paper Pro Platinum PT-101 • Plain: A3, A4, or Letter sized plain paper <p>When Paper type is set to Plain, borderless printing will be disabled even when Layout is set to Borderless.</p> <p>* Available only with a Canon-brand PictBridge compliant device. (May not be available with some Canon-brand PictBridge compliant devices.)</p>
Layout	<p>Default (Borderless), Index, Borderless, Bordered, 20-up*1, 35-up*2</p> <p>*1 With a Canon brand PictBridge compliant device, selecting items with "i" mark allows you to print shooting info (Exif Data) in list format (20-up) or on the margins of the specified data (1-up). (May not be available with some Canon-brand PictBridge compliant devices.)</p> <p>*2 Printed in 35 mm Film Style Layout (Contact Printing Layout). Available only with a Canon-brand PictBridge compliant device. (May not be available with some Canon-brand PictBridge compliant devices.)</p>
Print date & file no.	Default (Off: No printing), Date, File No., Both, Off

Image optimize	<p>Default (Off: No optimizing), On (Auto photo fix)*1, Off, Red-Eye*2</p> <p>*1 The scene or person's face of a shot photo is recognized and the most suitable correction for each photo is made automatically. It makes a darkened face by backlight brighter to print. It also analyzes a scene such as scenery, night scene, person, etc. and corrects each scene with the most suitable color, brightness, or contrasts automatically to print.</p> <p>*2 Can be selected only on certain Canon-brand PictBridge compliant devices. (May not be selected depending on the device.)</p> <ul style="list-style-type: none"> • With some types of Canon PictBridge compliant cameras, you can make finer color adjustments by selecting the color mode that is most suitable for what you want to achieve. Refer to Digital Photo Printing Guide or the instruction manual provided with your Canon PictBridge compliant device. You can select the following color modes: Natural, Natural M, B/W, Cool tone, Warm tone
Trimming	Default (Off: No trimming), On (follow the camera's setting), Off

Troubleshooting

- ▶ **The Printer Cannot Be Powered On**
- ▶ **Printing Does Not Start**
- ▶ **Paper Does Not Feed Properly/"No Paper" Error Occurs**
- ▶ **Print Results Not Satisfactory**
- ▶ **Ink Is Not Ejected**
- ▶ **Paper Jams**
- ▶ **If an Error Occurs**
- ▶ **Cannot Print on the Disc Label**
- ▶ **List of Support Code for Error**

Search Each Function

- ▶ **Problems with Network Communication**
- ▶ **Problems while Printing from Smartphone/Tablet**
- ▶ **Problems with Printing**
- ▶ **Problems with the Printer**
- ▶ **Problems with Installation/Downloading**
- ▶ **About Errors/Messages Displayed**
- ▶ **If You Cannot Resolve the Problem**

Problems with Network Communication

- **Cannot Detect a Printer on a Network**
- **Problems with the Printer while Using with Network**
- **Other Problems with Network**

Cannot Detect a Printer on a Network

- ▶ **Cannot Detect the Printer when Setting Up Network Communication**
- ▶ **The Printer Cannot Be Detected in the Wireless LAN**
- ▶ **The Printer Cannot Be Detected in the Wired LAN**

▶▶▶ **Note**

- You cannot use the wireless LAN and the wired LAN at the same time.

Cannot Detect the Printer when Setting Up Network Communication

If the printer could not be detected on the network when setting up the network communication, confirm the network settings before redetecting the printer.

■ [Cannot Detect the Printer during Wireless LAN Setup: Check 1](#)

■ [Cannot Detect the Printer during Wired LAN Setup: Check 1](#)



Cannot Detect the Printer during Wireless LAN Setup: Check 1



Are the computer and network device (router, etc.) configured and can the computer connect to the network?

Make sure that you can view web pages on your computer.

If you cannot view any web pages:

Configure the computer and network device.

For the procedures, refer to the instruction manuals supplied with the computer and network device, or contact their manufacturers.

If you can view web pages after configuring the computer and network device, try to set up the network communication from the beginning.

If you can view web pages:

Go to check 2.

■ [Cannot Detect the Printer during Wireless LAN Setup: Check 2](#)



Cannot Detect the Printer during Wireless LAN Setup: Check 2



Does the firewall function of your security software or operating system for a computer interfere with setting up the network communication?

The firewall function of your security software or operating system for a computer may limit communications between the printer and your computer. Confirm the setting of firewall function of your security software or operating system or the message appearing on your computer.

If the firewall function interferes with setting up:

- **When the message appears on your computer:**

If the message warning that Canon software is attempting to access the network appears on the computer, set the security software to allow access.

- **When the message does not appear on your computer:**

Cancel to set up, then set the security software to allow Canon software* to access the network.

* Set the security software to allow **Setup.app**, **Canon IJ Network Tool.app**, **canonijnetwork.bundle**, **CIJScannerRegister.app**, **Canon IJ Scan Utility2.app**, and **CIJSUAgent.app** to access the network.

After setting the security software, try to set up the network communication from the beginning.

▶▶▶ Note

- For the operating system firewall settings or the security software firewall settings, refer to the instruction manual of the computer or software, or contact its manufacturer.

If there is no problem with the firewall settings:

Go to check 3.

■ [Cannot Detect the Printer during Wireless LAN Setup: Check 3](#)



Cannot Detect the Printer during Wireless LAN Setup: Check 3



Check the settings of the wireless router.

Check the settings of the wireless router for the network connection such as IP address filtering, MAC address filtering, or DHCP function.

Make sure that the radio channel of the wireless router and that assigned to the printer are the same.

For details on how to check the settings of the wireless router, refer to the instruction manual supplied with the wireless router or contact its manufacturer.

If there is no problem with the settings of the wireless router:

Go to check 4.

■ [Cannot Detect the Printer during Wireless LAN Setup: Check 4](#)



Cannot Detect the Printer during Wireless LAN Setup: Check 4



Make sure that the printer is not placed far away from the wireless router.

The wireless router is located indoors within the effective range for wireless communication. Locate the printer within 164 ft. / 50 m from the wireless router.

In addition, check where the printer and the wireless router are located and take the appropriate action.

- Make sure that there is no obstruction between the printer and the wireless router.

Wireless communication between different rooms or floors is generally poor. Adjust the location of the printer and the wireless router.

- Make sure that there is no source of radio wave interference near the printer or the wireless router.

If a device (e.g. microwave oven) using the same frequency bandwidth as the wireless station is placed nearby, the device may cause interference. Place the printer or the wireless router as far away from the interference source as possible.

After checking above and taking the appropriate action, perform setup again.

▶▶ Note

- You can set up the network communication via USB. To set up via USB, select the **Set up the network connection via USB** check box on the **Check Printer Settings** screen and click **Next**.



Cannot Detect the Printer during Wired LAN Setup: Check 1



Is the LAN cable connected, and are the printer and the router turned on?

Make sure that the LAN cable is connected.

Make sure that the printer is turned on.

■[Confirming that the Power Is On](#)

Make sure that the router is turned on.

If the LAN cable is connected and the printer or the network device is turned off:

Turn on the printer or the network device.

After turning on the printer or the network device, it may take some time until ready for use. After a while just turning on the printer or the network device, click **Redetect** on the **Check Printer Settings** screen.

When the printer is detected, follow the instructions on the screen to continue to set up the network communication.

If the LAN cable is connected and the printer and the network device are turned on:

If the printer could not be detected after clicking **Redetect** even when the printer and the network device are turned on, or when you have turned them on, go to check 2.

■[Cannot Detect the Printer during Wired LAN Setup: Check 2](#)



Cannot Detect the Printer during Wired LAN Setup: Check 2



Are the computer and the router configured and can the computer connect to the network?

Make sure that you can view web pages on your computer.

If you cannot view any web pages:

Click **Cancel** on the **Check Printer Settings** screen to cancel to set up the network communication. After that, configure the computer and network device.

For the procedures, refer to the instruction manuals supplied with the computer and network device, or contact their manufacturers.

If you can view web pages after configuring the computer and network device, try to set up the network communication from the beginning.

If you can view web pages:

Go to check 3.

■ [Cannot Detect the Printer during Wired LAN Setup: Check 3](#)



Cannot Detect the Printer during Wired LAN Setup: Check 3



Enable the wired LAN setting of the printer.

Press and hold the **RESUME/CANCEL** button, then release the button when the **POWER** lamp flashes 11 times.

Note

- To check whether the wired LAN is enabled, print out the network setting information.

■ [Printing Out Network Setting Information](#)



The Printer Cannot Be Detected in the Wireless LAN



Check1 Make sure that the printer is turned on.

Check2 Make sure that the **Wi-Fi** lamp is lit on the printer.

If the **Wi-Fi** lamp is off, the wireless LAN is disabled.

To enable wireless LAN, press and hold the **RESUME/CANCEL** button, then release the button when the **POWER** lamp flashes 10 times.

Wireless LAN is enabled and the **Wi-Fi** lamp is lit.

Check3 When the printer is connected to the computer temporarily using a USB cable, make sure that the USB cable is connected properly.

When you set up the wireless LAN connection or change the wireless LAN settings using IJ Network Tool through USB connection, make sure that the printer is connected to the computer with a USB cable securely.

■ [Connecting the Printer to the Computer Using a USB Cable](#)

Check4 Make sure that the printer setup is completed.

If not, perform setup according to the instructions on our website.

Check5 When using IJ Network Tool, click **Update** to search for the printer again.

■ [Canon IJ Network Tool Screen](#)

Check6 Make sure that the network settings in the printer are identical with those of the wireless router.

Refer to the instruction manual provided with the wireless router or contact its manufacturer to check the wireless router settings, and then modify the printer settings.

■ [How to Set an Encryption Key](#)

Check7 Make sure that there is no obstruction.

Wireless communication between different rooms or floors is generally poor. Adjust the location of the devices.

Check8 Make sure that the printer is not placed far away from the wireless router.

The wireless router is located indoors within the effective range for wireless communication. Locate the printer within 164 ft. / 50 m from the wireless router.

Check9 Make sure that there is no source of radio wave interference in your vicinity.

If a device (e.g. microwave oven) using the same frequency bandwidth as the wireless station is placed nearby, the device may cause interference. Place the wireless station as far away from the interference source as possible.

Check10 Make sure that the network settings of the computer are correct.

Make sure that the computer can communicate with the wireless router over the wireless LAN.

Check11 Make sure that the firewall of the security software is disabled.

If the firewall function of your security software is turned on, a message may appear warning that Canon software is attempting to access the network. If the warning message appears, set the security software to always allow access.

If using any programs that switch the network environment, check their settings. Some programs will enable a firewall by default.

Check12 When using a router, connect the printer and computer to the LAN side (same network segment).

Check13 When the printer is connected to an AirPort Base Station via a LAN, use alphanumeric characters for the name of the network (SSID).

Check14 Confirm the TCP/IP setting of the printer and disable IPv6.

To check the current TCP/IP setting, print out the network setting information.

[■ Printing Out Network Setting Information](#)

When "TCP/IP Version" is set to "IPv4 & IPv6", both IPv4 and IPv6 are enabled.

Press and hold the **RESUME/CANCEL** button, then release the button when the **POWER** lamp flashes 17 times.

IPv6 is disabled and only IPv4 is enabled.

If the problem is not resolved, perform setup again according to the instructions on our website.



The Printer Cannot Be Detected in the Wired LAN



Check1 Make sure that the printer is turned on.

Check2 Is the wired LAN setting of the printer enabled?

To check whether the wired LAN is enabled, print out the network setting information.

■ [Printing Out Network Setting Information](#)

If the wired LAN is disabled, press and hold the **RESUME/CANCEL** button, then release the button when the **POWER** lamp flashes 11 times. The wired LAN is enabled.

Check3 Make sure that the LAN cable is connected properly.

Make sure that the printer is connected to the router with the LAN cable. If the LAN cable is loose, connect the cable properly.

If the LAN cable is connected to the WAN side of the router, connect the cable to the LAN side of the router.

Problems with the Printer while Using with Network

- **The Printer Stopped Working Suddenly**
- **Forgot a Wireless Router Name, SSID, or a Network Key**
- **The Administrator Password Set to the Printer Was Forgotten**
- **Cannot Use the Printer on Replacing a Wireless Router or Changing Its Settings**
- **Printing Speed Is Slow**

The Printer Stopped Working Suddenly

■ [Cannot Communicate with the Printer over the Wireless LAN](#)

■ [Cannot Communicate with the Printer over the Wired LAN](#)

■ [Cannot Print from a Computer Connected to the Network](#)



Cannot Communicate with the Printer over the Wireless LAN



Check1 Make sure that the printer is turned on.

Check2 Are the network settings of the printer identical with those of the wireless router?

Make sure that the network settings of the printer (e.g. wireless router name, SSID, network key, etc.) are identical with those of the wireless router.

To check the settings of the wireless router, refer to the instruction manual provided with it or contact its manufacturer.

To check the current network settings of the printer, print out the network setting information.

■ [Printing Out Network Setting Information](#)

If the network settings of the printer are not identical with those of the wireless router, change the network settings of the printer to match with those of the wireless router using IJ Network Tool.

Check3 Make sure that the printer is not placed far away from the wireless router.

The wireless router is located indoors within the effective range for wireless communication. Locate the printer within 164 ft. / 50 m from the wireless router.

Check4 Make sure that there is no obstruction.

Wireless communication between different rooms or floors is generally poor. Adjust the location of the devices.

Check5 Make sure that there is no source of radio wave interference in your vicinity.

If a device (e.g. microwave oven) using the same frequency bandwidth as the wireless station is placed nearby, the device may cause interference. Place the wireless station as far away from the interference source as possible.

Check6 Make sure that the network settings of the computer are correct.

For the procedures to connect a network device to the computer and set them up, refer to the instruction manual of your network device or contact its manufacturer.

Check7 Make sure that the radio status is good and adjust the installation positions while monitoring the radio status with IJ Network Tool.

■ [Monitoring Wireless Network Status](#)

Check8 Make sure that a valid wireless channel is used.

The wireless channel to be used may be limited depending on wireless network devices installed in the computer. Refer to the instruction manual provided with your computer or your wireless network device to specify the valid wireless channel.

Check9 Make sure that the channel confirmed in Check 8 can communicate with the computer.

If not, change the channel set to the wireless router.

Check10 Make sure that the firewall of the security software is disabled.

If the firewall function of your security software is turned on, a message may appear warning that Canon software is attempting to access the network. If the warning message appears, set the security software to always allow access.

If using any programs that switch the network environment, check their settings. Some programs will enable a firewall by default.

Check11 When using a router, connect the printer and computer to the LAN side (same network segment).

Check12 When the printer is connected to an AirPort Base Station via a LAN, use alphanumeric characters for the name of the network (SSID).

If the problem is not resolved, perform setup again according to the instructions on our website.

- **For placement:**

Make sure that there is no barrier or obstacle between the wireless router and the printer.

Cannot Communicate with the Printer over the Wired LAN

Check1 Make sure that the printer is turned on.

Check2 Make sure that the LAN cable is connected properly.

Make sure that the printer is connected to the router with the LAN cable. If the LAN cable is loose, connect the cable properly.

If the LAN cable is connected to the WAN side of the router, connect the cable to the LAN side of the router.

If the problem is not resolved, perform setup again according to the instructions on our website.

Cannot Print from a Computer Connected to the Network

Check1 Make sure that the network settings of the computer are correct.

For the procedures to set up the computer, refer to the instruction manual of your computer or contact its manufacturer.

Check2 If the printer driver is not installed, install it.

Install the printer driver from our website.

Check3 When using wireless LAN, make sure that access control is not set to the wireless router.

For the procedures to connect a wireless router and set it up, refer to the instruction manual of your wireless router or contact its manufacturer.

▶▶ Note

- To check the MAC address or the IP address of the computer, see [Checking the IP Address or the MAC Address of the Computer](#).

Forgot a Wireless Router Name, SSID, or a Network Key

■ [Cannot Connect with a Wireless Router to Which a WEP or WPA/WPA2 Key Is Set \(You Forgot the WEP or WPA/WPA2 Key\)](#)

■ [How to Set an Encryption Key](#)

Cannot Connect with a Wireless Router to Which a WEP or WPA/WPA2 Key Is Set (You Forgot the WEP or WPA/WPA2 Key)

A

For information on how to set up the wireless router, refer to the instruction manual provided with the wireless router or contact its manufacturer. Make sure that the computer and the wireless router can communicate with each other.

After that, set up the printer to match the settings of the wireless router using IJ Network Tool.

How to Set an Encryption Key

A

For information on how to set up the wireless router, refer to the instruction manual provided with the wireless router or contact its manufacturer. Make sure that the computer and the wireless router can communicate with each other.

After that, set up the printer to match the settings of the wireless router using IJ Network Tool.

- **When using WEP**

The key length, key format, the key to use (one of 1 to 4), and the authentication method must match among the wireless router, the printer, and the computer.

In order to communicate with a wireless router that uses automatically generated WEP keys, you must configure the printer to use the key generated by the wireless router by entering it in hexadecimal format.

Normally, select **Auto** for the authentication method. Otherwise, select **Open System** or **Shared Key** according to the setting of the wireless router.

When the **WEP Details** screen appears after clicking **Set** on the **Wireless Routers** screen, follow the on-screen instructions and set the key length, the key format, the key number, and the authentication to enter a WEP key.

For details, see [Changing the WEP Detailed Settings](#).

Note

- When the printer is connected to an AirPort Base Station via a LAN:

When the printer is connected to an AirPort Base Station via a LAN, confirm the settings in **Wireless Security** of **AirPort Utility**.

- Select **64 bit** if **WEP 40 bit** is selected for the key length in the AirPort Base Station.

- Select **1** for **Key ID**:. Otherwise your computer will not be able to communicate with the printer via the wireless router.

- **When using WPA/WPA2**

The authentication method, passphrase, and dynamic encryption type must match on the wireless router, the printer, and the computer.

Enter the passphrase configured on the wireless router (a sequence of between 8 and 63 alphanumeric characters, or a 64-character hexadecimal number).

Either TKIP (basic encryption) or AES (secure encryption) is selected automatically for the dynamic encryption method.

For details, see [Changing the WPA/WPA2 Detailed Settings](#).

▶▶▶ Note

- This printer supports WPA/WPA2-PSK (WPA/WPA2-Personal) and WPA2-PSK (WPA2-Personal).



The Administrator Password Set to the Printer Was Forgotten



Initialize the printer settings.

■ [Initializing the Printer Settings](#)

After initializing the printer settings, perform setup according to the instructions on our website.



Cannot Use the Printer on Replacing a Wireless Router or Changing Its Settings



When you replace a wireless router, perform network setup of the printer again.

Perform network setup again according to the instructions on our website.

If the problem is not resolved, see below.

■ [Cannot Communicate with the Printer after Applying MAC/IP Address Filtering or Entering an Encryption Key to the Wireless Router](#)

■ [When Encryption Is Enabled, Cannot Communicate with the Printer after the Encryption Type Was Switched on the Wireless Router](#)



Cannot Communicate with the Printer after Applying MAC/IP Address Filtering or Entering an Encryption Key to the Wireless Router



Check1 Confirm the wireless router setting.

Refer to the instruction manual provided with the wireless router or contact its manufacturer to confirm the wireless router setting. Make sure that the computer and the wireless router can communicate with each other under this setting.

Check2 If you are performing MAC address filtering or IP address filtering at the

wireless router, confirm that the MAC address or IP address for both the computer or the network device and the printer are registered.

Check3 If you are using a WEP or WPA/WPA2 key, make sure that the encryption

key for the computer or the network device and the printer matches that set to the wireless router.

Besides the WEP key itself, the key length, key format, the key ID to use, and the authentication method must match among the printer, the wireless router, and the computer.

Normally, select **Auto** for the authentication method. If you want to specify the method manually, select **Open System** or **Shared Key** according to the setting of the wireless router.

■ [How to Set an Encryption Key](#)

Q When Encryption Is Enabled, Cannot Communicate with the Printer after the Encryption Type Was Switched on the Wireless Router

A

If the printer cannot communicate with the computer after the encryption type of the printer was switched, make sure that encryption types for the computer and the wireless router matches that set to the printer.

■ [Cannot Communicate with the Printer after Applying MAC/IP Address Filtering or Entering an Encryption Key to the Wireless Router](#)



Printing Speed Is Slow



Check1 The printer may be printing out a large job issued from another computer.

Check2 When using wireless LAN, make sure that the radio status is good and adjust the installation positions while monitoring the radio status with IJ Network Tool.

■ [Monitoring Wireless Network Status](#)

Make sure that there is no barrier or obstacle between the wireless router and the printer. Wireless communication between different rooms or floors is generally poor. The metal, concrete, or timber including the metallic material, mud wall, or insulator may interrupt a wireless communication. If the printer cannot communicate with the computer over a wireless LAN for the wall material, place the printer and the computer in the same room or floor.

Check3 When using wireless LAN, make sure that there is no source of interference in your vicinity.

If a device (e.g. microwave oven) using the same frequency bandwidth as the wireless station is placed nearby, the device may cause interference. Place the wireless station as far away from the interference source as possible.

Other Problems with Network

- **The Message Is Displayed on the Computer Screen during Setup**
- **Checking Information about the Network**
- **How to Restore the Printer's Network Settings to Factory Default**

The Message Is Displayed on the Computer Screen during Setup

■ [The Enter Password Screen Is Displayed during Setup](#)

■ [The Screen for Setting the Encryption Is Displayed after Selecting the Wireless Router in the Wireless Routers Screen](#)

■ ["You are connecting the printer to the non encrypted wireless network" Is Displayed](#)

Q The Enter Password Screen Is Displayed during Setup

A

The following screen is displayed if an administrator password is set to the printer which has already been set up to use via a network.



Enter the administrator password you have set.

►► Note

- An administrator password is already specified for the printer at the time of purchase.

For details:

■ [About the Administrator Password](#)

For improving security, we recommend to change the administrator password.

■ [Changing the Settings in the Admin Password Sheet](#)

Q The Screen for Setting the Encryption Is Displayed after Selecting the Wireless Router in the Wireless Routers Screen

A

This screen is displayed automatically if the selected wireless router is encrypted. In this case, configure the details to use the same encryption settings set to the wireless router.

For information on the encryption settings, see [Changing the Settings in the Wireless LAN Sheet](#).

Q "You are connecting the printer to the non encrypted wireless network" Is Displayed

A

Security is not configured on the wireless router. The printer can still be used, so continue the setup procedure to complete it.

»» Important

- If you connect to a network that is not protected with security measures, there is a risk of disclosing data such as your personal information to a third party.

Checking Information about the Network

■ [Checking the IP Address or the MAC Address of the Printer](#)

■ [Checking the IP Address or the MAC Address of the Computer](#)

■ [Checking If the Computer and the Printer, or Computer and the Wireless Router Can Communicate](#)

■ [Checking the Network Setting Information](#)



Checking the IP Address or the MAC Address of the Printer



To check the IP address or the MAC address of the printer, print out the network setting information.

■ [Printing Out Network Setting Information](#)

To display the network setting information using IJ Network Tool, select **Network Information** on the **View** menu.

■ [Canon IJ Network Tool Menus](#)



Checking the IP Address or the MAC Address of the Computer



To check the IP address or MAC address assigned to the computer, follow the procedure below.

1. Select **System Preferences** from the Apple menu, then click **Network**.
2. Make sure that the network interface you are using on your computer is selected, then click **Advanced**.

When you are using wireless LAN on your computer, make sure that **Wi-Fi** is selected as the network interface. When you are using wired LAN, make sure that **Ethernet** is selected.

3. Confirm the IP address or MAC address.

Click **TCP/IP** to confirm the IP address.

Click **Hardware** to confirm the MAC address.



Checking If the Computer and the Printer, or Computer and the Wireless Router Can Communicate



To check that communication is available, perform the ping test.

1. Open the **Utilities** folder in the **Applications** folder.

2. Start **Network Utility**.
3. Click the **Ping** button.
4. Make sure that **Send only XX pings** (XX are numbers) is selected.
5. Enter the IP address of the target printer or the target wireless router in **Enter the network address to ping..**
6. Click **Ping**.

"XXX.XXX.XXX.XXX" is the IP address of the target device.

A message such as the following is displayed.

```
64 bytes from XXX.XXX.XXX.XXX: icmp_seq=0 ttl=64 time=3.394 ms
```

```
64 bytes from XXX.XXX.XXX.XXX: icmp_seq=1 ttl=64 time=1.786 ms
```

```
64 bytes from XXX.XXX.XXX.XXX: icmp_seq=2 ttl=64 time=1.739 ms
```

```
--- XXX.XXX.XXX.XXX ping statistics ---
```

```
3 packets transmitted, 3 packets received, 0% packet loss
```

If the packet loss is 100%, the communication is not available. Otherwise, the computer is communicating with the target device.



Checking the Network Setting Information



To check the network setting information of the printer, print out the network setting information.

■ [Printing Out Network Setting Information](#)



How to Restore the Printer's Network Settings to Factory Default



»» Important

- Note that initialization erases all network settings on the printer, and printing operation from a computer over network becomes impossible. To use the printer over network, perform setup according to the instructions on our website.

Press and hold the **RESUME/CANCEL** button, then release the button when the **POWER** lamp flashes 9 times.

The network settings are initialized.

Problems while Printing from Smartphone/Tablet

- ▶ **Cannot Print from Smartphone/Tablet**



Cannot Print from Smartphone/Tablet



If you cannot print from your smartphone/tablet, it is possible that your smartphone/tablet cannot communicate with the printer.

If you cannot print from your smartphone/tablet over the wireless LAN, confirm the following.

▶▶▶ Note

- For problems on printing with other connection methods or details on how to perform settings of each connection method:

■ [Using PIXMA Cloud Link](#)

■ [Printing from AirPrint Compliant Device](#)

Check1 Make sure that the printer is turned on.

Check2 Are the network settings of the printer identical with those of the wireless router?

Make sure that the network settings of the printer (e.g. wireless router name, SSID, network key, etc.) are identical with those of the wireless router.

To check the settings of the wireless router, refer to the instruction manual provided with it or contact its manufacturer.

To check the current network settings of the printer, print out the network setting information.

■ [Printing Out Network Setting Information](#)

If the network settings of the printer are not identical with those of the wireless router, change the network settings of the printer to match with those of the wireless router using IJ Network Tool.

Check3 Are the network settings of your smartphone/tablet identical with those of the wireless router?

Make sure that the network settings of your smartphone/tablet (e.g. wireless router name, SSID, network key, etc.) are identical with those of the wireless router.

To check the settings of your smartphone/tablet, refer to the instruction manual provided with it.

If the network settings of your smartphone/tablet are not identical with those of the wireless router, change the network settings of it to match with those of the wireless router.

Check4 Make sure that the printer is not placed far away from the wireless router.

The wireless router is located indoors within the effective range for wireless communication. Locate the printer within 164 ft. / 50 m from the wireless router.

Check5 Make sure that there is no obstruction.

Wireless communication between different rooms or floors is generally poor. Adjust the location of the devices.

Check6 Make sure that there is no source of radio wave interference in your vicinity.

If a device (e.g. microwave oven) using the same frequency bandwidth as the wireless station is placed nearby, the device may cause interference. Place the wireless station as far away from the interference source as possible.

Problems with Printing

- **Printing Does Not Start**
- **Paper Jams**
- **Print Results Not Satisfactory**
- **Ink Is Not Ejected**
- **Paper Does Not Feed Properly/"No Paper" Error Occurs**
- **Cannot Print on the Disc Label**
- **Printing Stops Before It Is Completed**



Printing Does Not Start



Check1 Make sure that the power plug is securely plugged in, then press the **ON** button to turn the printer on.

While the **POWER** lamp is flashing, the printer is initializing. Wait until the **POWER** lamp stops flashing and remains lit.

▶▶ Note

- When printing large data such as a photo or graphics, it may take longer to start printing. While the **POWER** lamp is flashing, the computer is processing data and sending it to the printer. Wait until printing starts.

Check2 Make sure that the printer is connected to your computer properly.

When the printer is connected to your computer with a USB cable, make sure that the USB cable is securely plugged in to the printer and the computer, then check the followings:

- If you are using a relay device such as a USB hub, disconnect it, connect the printer directly to the computer, and try printing again. If printing starts normally, there is a problem with the relay device. Consult the reseller of the relay device for details.
- There could also be a problem with the USB cable. Replace the USB cable and try printing again.

When you use the printer over LAN, make sure that the printer is connected to the network with a LAN cable or is set up correctly.

Check3 If you are printing from the computer and there are any unnecessary print jobs, delete them.

■ [Deleting the Undesired Print Job](#)

Check4 Make sure that the disc tray guide is closed.

If the disc tray guide is opened, close the disc tray guide and press the **RESUME/CANCEL** button on the printer.

Check5 Is the manual feed tray in the paper feed position?

If the manual feed tray is in the paper jam clearing position, return the tray to the paper feed position and press the **RESUME/CANCEL** button on the printer.

Check6 Is the feed slot cover closed?

If the feed slot cover is opened, close it slowly and press the **RESUME/CANCEL** button.

Check7 Does the page size setting match the size of the paper loaded in the printer?

Press the **RESUME/CANCEL** button on the printer to clear the error. Then check the **Paper Size** setting in the Page Setup dialog and load paper that is the same size as the setting and try printing again.

Set the printer not to detect the width of the paper using the Canon IJ Printer Utility.

To set the printer not to detect the width of the paper, open the Canon IJ Printer Utility, select **Custom Settings** in the pop-up menu, clear the **Detect paper width** check box, and then click **Apply**.

To open the Canon IJ Printer Utility, see [Opening the Canon IJ Printer Utility](#).

* Select the **Detect paper width** check box again once printing is complete, and then click **Apply**.

Check8 Are the Media Type and the Page Size settings of the printer driver correct?

When using non Canon genuine specialty paper, be sure to select the proper media type or page size correctly in the printer driver.

Confirm the settings following the procedure below, and try printing again.

1. Make sure that **A3 (Art Paper Margin 30)**, **A3+ (Art Paper Margin 30)**, **A4 (Art Paper Margin 30)**, **US Letter (Art Paper Margin 30)**, or **Tabloid (Art Paper Margin 30)** is selected in the application.

If the page size you want to use is not displayed, open the **File** menu of the application and select **Print**. Then make sure that the name of your printer is selected.

2. Make sure that the paper selected for **Media Type** in the Print dialog in the printer driver matches the paper loaded in the printer.
3. Make sure that the **Paper Size** setting in the Page Setup dialog in the printer driver is the same as the size set in step 1.

Check9 Make sure that your printer's name is selected in the Print dialog.

The printer will not print properly if you are using a printer driver for a different printer.

Make sure that your printer's name is selected in **Printer** in the Print dialog.

▶▶▶ Note

- To make the printer the one selected by default, select the printer for **Default printer**.

Check10 Restart your computer if you are printing from the computer.



Paper Jams

A

When paper is jammed, the **Alarm** lamp flashes and a troubleshooting message is displayed on the computer screen automatically. Take the appropriate action described in the message.

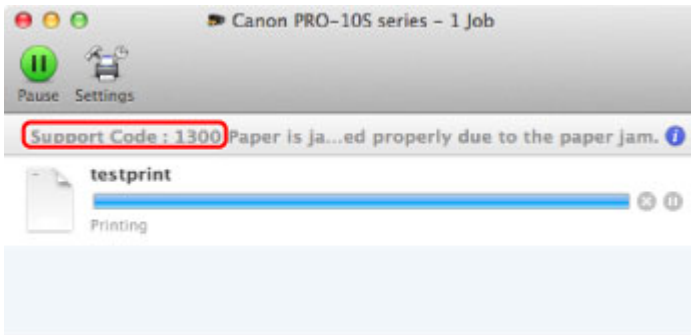

* The screen differs depending on the OS you are using.

For details on how to remove the jammed paper, refer to [List of Support Code for Error \(When Paper Is Jammed\)](#).

▶▶▶ Note

- You can confirm the actions against errors with Support Codes on your computer by searching a Support Code.

■ [Click Here to Search](#)



Print Results Not Satisfactory



If the print result is not satisfactory due to white streaks, misaligned lines, or uneven colors, confirm the paper and print quality settings first.

Check1 Do the page size and media type settings match the size and type of the loaded paper?

When these settings are incorrect, you cannot obtain a proper print result.

If you are printing a photograph or an illustration, incorrect paper type settings may reduce the quality of the printout color.

Also, if you print with an incorrect paper type setting, the printed surface may be scratched.

In borderless printing, uneven coloring may occur depending on the combination of the paper type setting and the loaded paper.

The method of confirming the paper and print quality settings differs depending on what you do with your printer.

To print from a PictBridge compliant device	Confirm by using your PictBridge compliant device. ■ ■ Printing Photographs Directly from a PictBridge Compliant Device
To print from a computer	Confirm by using the printer driver. ■ ■ Printing with Easy Setup

Check2 Make sure that the appropriate print quality is selected referring to the table in Check 1.

Select a print quality option suitable for the paper and image for printing. If you notice blurs or uneven colors, increase the print quality and try printing again.

▶▶▶ Note

- You cannot change the print quality setting from a PictBridge compliant device.

Check3 When using wireless LAN, make sure that the radio status is good.

[■ ■ Monitoring Wireless Network Status](#)

If the radio status is poor, it may be possible that print results are not satisfactory or the printing speed is slow. Try printing again after the radio status improves.

If the problem is not resolved even after the radio status improves, use the printer via USB or a wired LAN.

Check4 If the problem is not resolved, there may be other causes.

See also the sections below:

[■ ■ Cannot Print to End of Job](#)

[■ ■ No Printing Results/Printing Is Blurred/Colors Are Wrong/White Streaks](#)

[■ ■ Lines Are Misaligned](#)

■ [Printed Paper Curls or Has Ink Blots](#)

■ [Paper Is Smudged/Printed Surface Is Scratched](#)

■ [Back of the Paper Is Smudged](#)

■ [Vertical Lines Are Printed on the Sides of the Printout](#)

■ [Colors Are Uneven or Streaked](#)



Cannot Print to End of Job



Check Is the space of your computer's hard disk sufficient?

Delete unnecessary files to free disk space.



No Printing Results/Printing Is Blurred/Colors Are Wrong/White Streaks

❖ No Printing Results



❖ Printing Is Blurred

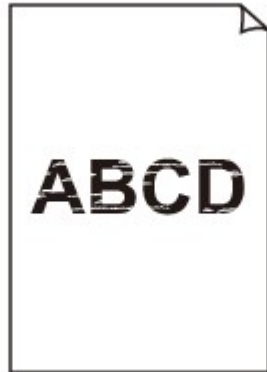

❖ Colors Are Wrong



White Streaks

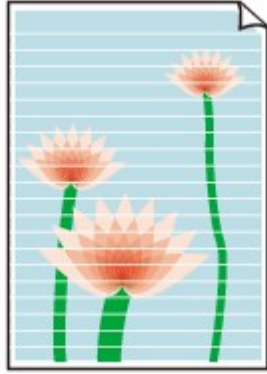

A

Check1 Did you confirm the paper and print quality settings?

■ [Print Results Not Satisfactory](#)

Check2 Check the status of ink tanks. Replace the ink tank if the ink has run out.

■ [Replacing an Ink Tank](#)

Check3 Print the Nozzle Check Pattern and perform any necessary maintenance operations such as Print Head Cleaning.

Print the Nozzle Check Pattern to determine whether the ink ejects properly from the print head nozzles.

Refer to [When Printing Becomes Faint or Colors Are Incorrect](#) for the Nozzle Check Pattern printing, Print Head Cleaning, and Print Head Deep Cleaning.

- If the Nozzle Check Pattern is not printed correctly:

Check to see if a particular color's ink tank is not empty.

If the Nozzle Check Pattern is not printed correctly though ink is sufficient, perform the Print Head Cleaning and try printing the Nozzle Check Pattern again.

- If the problem is not resolved after performing the Print Head Cleaning twice:

Perform the Print Head Deep Cleaning.

If the problem is not resolved after performing the Print Head Deep Cleaning, turn off the printer and perform another Print Head Deep Cleaning after 24 hours.

- If the problem is not resolved after performing the Print Head Deep Cleaning twice:

If Print Head Deep Cleaning does not resolve the problem, the print head may be damaged. Contact the service center.

Check4 When using paper with one printable surface, make sure that the paper is loaded with the printable side facing up.

Printing on the wrong side of such paper may cause unclear prints or prints with reduced quality.

Load paper with the printable side facing up.

Refer to the instruction manual supplied with the paper for detailed information on the printable side.

Check5 Is automatic ink quality maintenance enabled?

If automatic ink quality maintenance is disabled, ink in one or more ink tanks may separate, resulting in uneven density. Enable automatic ink quality maintenance by using the printer driver.

1. Make sure that the printer is turned on.

2. Open the Canon IJ Printer Utility.

■ [Opening the Canon IJ Printer Utility](#)

3. Select **Custom Settings** in the pop-up menu.

4. Select the **Execute ink quality maintenance automatically** check box, then click **Apply**.

5. Confirm the message and click **OK**.

▶▶ Important

- Enabling automatic ink quality maintenance is recommended. Failure to perform the ink quality maintenance about once a week may affect print quality.
- If automatic ink quality maintenance has been disabled, perform the ink quality maintenance manually about once a week.

■ [Maintaining the Ink Quality](#)



Lines Are Misaligned



Check1 Did you confirm the paper and print quality settings?

[Print Results Not Satisfactory](#)

Check2 Perform Print Head Alignment.

If printed lines are misaligned or print results are otherwise unsatisfactory, adjust the print head position.

[Aligning the Print Head](#)

Note

- If the problem is not resolved after performing the Print Head Alignment, perform Print Head Alignment manually referring to [Aligning the Print Head Position from Your Computer](#).

Check3 Increase the print quality and try printing again.

Increasing the print quality in the printer driver may improve the print result.



Printed Paper Curls or Has Ink Blots

Printed Paper Has Ink Blots



Printed Paper Curls



Check1 Did you confirm the paper and print quality settings?

■ [Print Results Not Satisfactory](#)

Check2 If the intensity is set high, reduce the intensity setting and try printing again.

If you are using plain paper to print images with high intensity, the paper may absorb too much ink and become wavy, causing paper abrasion.

You can confirm the intensity using the printer driver.

■ [Adjusting Intensity](#)

Check3 Is Photo Paper used for printing photographs?

When printing data with high color saturation such as photographs or images in deep color, we recommend using Photo Paper Plus Glossy II or other Canon speciality paper.

■ [Media Types You Can Use](#)



Paper Is Smudged/Printed Surface Is Scratched

Paper Is Smudged

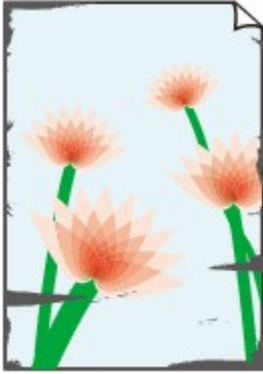

The Edges of Paper Are Smudged Printed Surface Is Smudged



Printed Surface Is Scratched



Check1 Did you confirm the paper and print quality settings?

 [Print Results Not Satisfactory](#)

Check2 Is the appropriate type of paper used? Check the followings:

- Check to see if the paper you are printing on is suitable for your printing purpose.

 [Media Types You Can Use](#)

- When performing Borderless Printing, make sure that the paper you are using is suitable for Borderless Printing.

If the paper you are using is not suitable for Borderless Printing, the print quality may be reduced at the top and bottom edges of the paper.

 [Printing Area](#)

Check3 Load the paper after correcting its curl.

When using Photo Paper Plus Semi-gloss, even if the sheet is curled, load one sheet at a time as it is. If you roll up this paper to flatten, this may cause cracks on the surface of the paper and reduce the print quality.

We recommend putting unused paper back into the package and keeping it on a level surface.

- **For Plain Paper**

Turn the paper over and reload it to print on the other side.

Leaving the paper loaded on the rear tray for a long time may cause the paper to curl. In this case, load the paper with the other side facing up. It may resolve the problem.

• For Other Paper

If the curl on the four corners of the paper is more than 0.1 inch / 3 mm (A) in height, the paper may be smudged or may not be fed properly. In such cases, follow the procedure described below to correct the paper curl.



1. Roll up the paper in the opposite direction to the paper curl as shown below.



2. Check that the paper is now flat.

We recommend printing curl-corrected paper one sheet at a time.

▶▶▶ Note

- Depending on the media type, the paper may be smudged or may not be fed properly even if it is not curled inward. In such cases, follow the procedure described below to curl the paper outward within 0.1 inch / 3 mm (B) in height before printing. This may improve the print result.

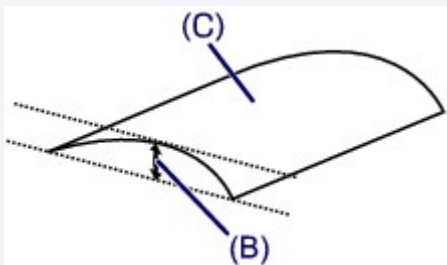

(C) Printing side

We recommend printing paper that has been curled outward one sheet at a time.

Check4 Adjust the setting to prevent paper abrasion.

Adjusting the setting to prevent paper abrasion will widen the clearance between the print head and the loaded paper. If you notice abrasion even with the media type set correctly to match the loaded paper, set the printer to prevent paper abrasion on the computer.

* Readjust the setting not to prevent paper abrasion once printing is complete. If not, this setting remains enabled for all subsequent print jobs.

In the Canon IJ Printer Utility, select **Custom Settings** in the pop-up menu, select the **Prevent paper abrasion** check box, and then click **Apply**.

To open the Canon IJ Printer Utility, see [Opening the Canon IJ Printer Utility](#).

Check5 If the intensity is set high, reduce the intensity setting and try printing again.

If you are using plain paper to print images with high intensity, the paper may absorb too much ink and become wavy, causing paper abrasion.

Reduce the intensity setting in the printer driver and try printing again.

1. Open the Print dialog.

■ [How to Open the Printer Driver Setup Window](#)

2. Select **Color Options** in the pop-up menu.

3. Drag the **Intensity** slide bar to set the intensity.

Check6 Is printing performed beyond the recommended printing area?

If you are printing beyond the recommended printing area of your printing paper, the lower edge of the paper may become stained with ink.

Resize your original document in your application software.

■ [Printing Area](#)

Check7 Is the paper feed roller dirty?

Clean the paper feed roller.

■ [Cleaning the Paper Feed Roller](#)

▶▶▶ Note

- Cleaning the paper feed roller will wear the roller, so perform this procedure only when necessary.

Check8 Is the inside of the printer dirty?

When performing duplex printing, the inside of the printer may become stained with ink, causing the printout to become smudged.

Perform the Bottom Plate Cleaning to clean the inside of the printer.

■ [Cleaning the Inside of the Printer \(Bottom Plate Cleaning\)](#)

▶▶▶ Note

- To prevent the inside of the printer from stains, set the paper size correctly.

Check9 Set the time to dry the printed surface longer.

Doing so gives the printed surface enough time to dry so that paper smudged and scratched are prevented.

1. Make sure that the printer is turned on.

2. Open the Canon IJ Printer Utility.

■ [Opening the Canon IJ Printer Utility](#)

3. Select **Custom Settings** in the pop-up menu.

4. Drag the **Ink Drying Wait Time:** slide bar to set the wait time, and then click **Apply**.

5. Confirm the message and click **OK**.



Back of the Paper Is Smudged

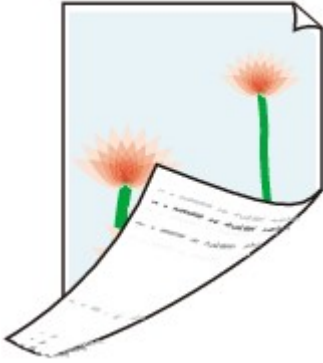

Check1 Did you confirm the paper and print quality settings?

[Print Results Not Satisfactory](#)

Check2 Perform the Bottom Plate Cleaning to clean the inside of the printer.

[Cleaning the Inside of the Printer \(Bottom Plate Cleaning\)](#)

▶▶ Note

- When performing borderless printing, duplex printing, or too much printing, the inside may become stained with ink.



Vertical Lines Are Printed on the Sides of the Printout

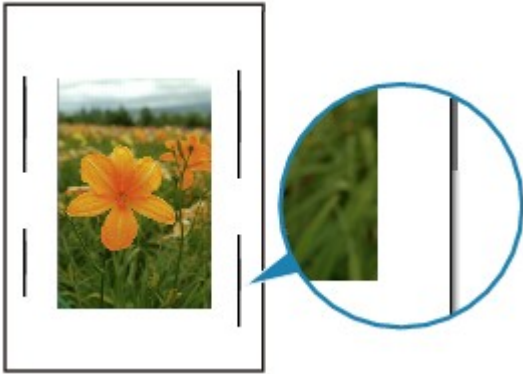

Check Is the size of the loaded paper correct?

The vertical lines may be printed in the margin if the size of the loaded paper is larger than that you have specified.

Set the paper size correctly according to the paper you loaded.

[Print Results Not Satisfactory](#)

Note

- The direction of the vertical line pattern may vary depending on the image data or the print setting.
- This printer performs automatic cleaning when necessary to keep printouts clean. A small amount of ink is ejected for cleaning.

Although ink is usually ejected on the ink absorber, it may be ejected on the paper if you load paper larger than that you have specified.



Colors Are Uneven or Streaked

Colors Are Uneven



Colors Are Streaked



Check1 Did you confirm the paper and print quality settings?

 [Print Results Not Satisfactory](#)

Check2 Print the Nozzle Check Pattern and perform any necessary maintenance operations such as Print Head Cleaning.

Print the Nozzle Check Pattern to determine whether the ink ejects properly from the print head nozzles.

Refer to [When Printing Becomes Faint or Colors Are Incorrect](#) for the Nozzle Check Pattern printing, Print Head Cleaning, and Print Head Deep Cleaning.

- If the Nozzle Check Pattern is not printed correctly:

Check to see if a particular color's ink tank is not empty.

If the Nozzle Check Pattern is not printed correctly though ink is sufficient, perform the Print Head Cleaning and try printing the Nozzle Check Pattern again.

- If the problem is not resolved after performing the Print Head Cleaning twice:

Perform the Print Head Deep Cleaning.

If the problem is not resolved after performing the Print Head Deep Cleaning, turn off the printer and perform another Print Head Deep Cleaning after 24 hours.

- If the problem is not resolved after performing the Print Head Deep Cleaning twice:

If Print Head Deep Cleaning does not resolve the problem, the print head may be damaged. Contact the service center.

Check3 Perform Print Head Alignment.

■ [Aligning the Print Head](#)

▶▶▶ **Note**

- If the problem is not resolved after performing the Print Head Alignment, perform Print Head Alignment manually referring to [Aligning the Print Head Position from Your Computer](#).

Check4 Is automatic ink quality maintenance enabled?

If automatic ink quality maintenance is disabled, ink in one or more ink tanks may separate, resulting in uneven density. Enable automatic ink quality maintenance by using the printer driver.

1. Make sure that the printer is turned on.
2. Open the Canon IJ Printer Utility.

■ [Opening the Canon IJ Printer Utility](#)

3. Select **Custom Settings** in the pop-up menu.
4. Select the **Execute ink quality maintenance automatically** check box, then click **Apply**.
5. Confirm the message and click **OK**.

▶▶▶ **Important**

- Enabling automatic ink quality maintenance is recommended. Failure to perform the ink quality maintenance about once a week may affect print quality.
- If automatic ink quality maintenance has been disabled, perform the ink quality maintenance manually about once a week.

■ [Maintaining the Ink Quality](#)



Ink Is Not Ejected



Check1 Has the ink run out?

Open the top cover, then check the status of ink lamp.

■ [Checking the Ink Status](#)

Check2 Are the print head nozzles clogged?

Print the Nozzle Check Pattern to determine whether the ink ejects properly from the print head nozzles.

Refer to [When Printing Becomes Faint or Colors Are Incorrect](#) for the Nozzle Check Pattern printing, Print Head Cleaning, and Print Head Deep Cleaning.

- If the Nozzle Check Pattern is not printed correctly:
 - Check to see if a particular color's ink tank is not empty.
 - If the Nozzle Check Pattern is not printed correctly though ink is sufficient, perform the Print Head Cleaning and try printing the Nozzle Check Pattern again.
- If the problem is not resolved after performing the Print Head Cleaning twice:
 - Perform the Print Head Deep Cleaning.
 - If the problem is not resolved after performing the Print Head Deep Cleaning, turn off the printer and perform another Print Head Deep Cleaning after 24 hours.
- If the problem is not resolved after performing the Print Head Deep Cleaning twice:
 - If Print Head Deep Cleaning does not resolve the problem, the print head may be damaged. Contact the service center.



Paper Does Not Feed Properly/"No Paper" Error Occurs



Check1 Make sure that paper is loaded.

 [Loading Paper](#)

Check2 Make sure of the following when you load paper.

In the rear tray:

- When loading two or more sheets of paper, flip through the paper before loading.



- When loading two or more sheets of paper, align the edges of the sheets before loading.
- When loading two or more sheets of paper, make sure that the paper stack does not exceed the paper load limit.

However, proper feeding of paper may not be possible at this maximum capacity depending on the type of paper or environmental conditions (either very high or low temperature and humidity). In such cases, reduce the sheets of paper you load at a time to less than half of the paper load limit.

- Always load the paper in portrait orientation, regardless of the printing orientation.

In the manual feed tray:

When you load the paper, load one sheet at a time. When you print continuously, set the next paper after the last one is finished printing.

Check3 Check to see if the paper you are printing on is not too thick or curled.

 [Media Types You Cannot Use](#)

Check4 Make sure of the following when you load Hagakis.

If a Hagaki is curled, it may not feed properly even though the paper stack does not exceed the paper load limit.

Load Hagakis with a zip code column downward.

Check5 Confirm that the media type and the paper size settings correspond with the loaded paper.

Check6 Make sure that there are not any foreign objects in the rear tray or manual feed tray.

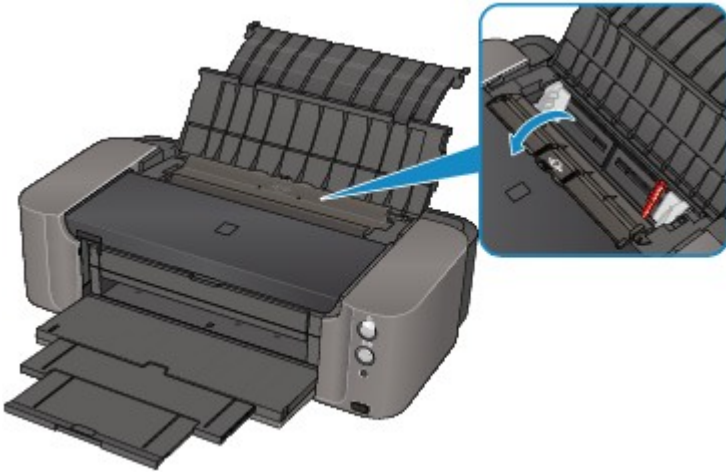

If the paper tears in the rear tray or the manual feed tray, see [Paper Jams](#) to remove it.

If there are any foreign objects in the rear tray or manual feed tray, be sure to turn off the printer, unplug it from the power supply, then remove the foreign object.

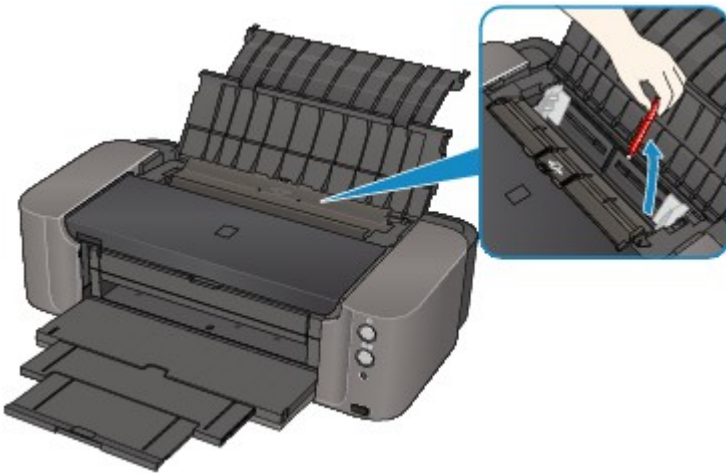

▶▶▶ Note

- If the feed slot cover is opened, close it slowly.

Check7 Make sure that the disc tray guide is closed completely.

Paper does not feed properly if the disc tray guide is even slightly open.

■ [Placing a Printable Disc](#)

Check8 Clean the paper feed roller.

■ [Cleaning the Paper Feed Roller](#)

▶▶▶ Note

- Cleaning the paper feed roller will wear the roller, so perform this procedure only when necessary.

Cannot Print on the Disc Label

■ [Disc Label Printing Does Not Start](#)

■ [Disc Tray Does Not Feed Properly](#)

■ [Disc Tray Jammed](#)

Disc Label Printing Does Not Start

A

Check1 Is the disc tray placed properly?

Open the disc tray guide, properly place the disc tray again, then press the **RESUME/CANCEL** button on the printer.

Use the disc tray supplied with this printer ("K" is on the upper side).

For details on how to place the disc tray, refer to [Placing a Printable Disc](#).

Check2 Is the printable disc placed on the disc tray?

Place the printable disc on the disc tray properly, then press the **RESUME/CANCEL** button.

Use the disc tray supplied with this printer ("K" is on the upper side).

For details on how to place the disc tray, refer to [Placing a Printable Disc](#).

Check3 If disc label printing stops before it is complete, try the operation again.

If a certain period of time has elapsed while disc label printing is in progress, the printer stops initializing.

The printer resumes initializing by pressing the **RESUME/CANCEL** button.

Try the operation again following the on-screen instructions.

Disc Tray Does Not Feed Properly

A

Check1 Is the disc tray placed properly?

Properly place the disc tray again, then press the **RESUME/CANCEL** button.

Use the disc tray supplied with this printer ("K" is on the upper side).

For details on how to place the disc tray, refer to [Placing a Printable Disc](#).

Check2 Unrecognizable printable disc may be placed.

Canon recommends that you use printable discs specially processed to be printed on by an inkjet printer.

Q Disc Tray Jammed

A

Pull out the disc tray gently.

If the disc tray cannot be pulled out, turn the printer off, then turn the printer back on again. The disc tray will automatically be ejected.

When the disc tray is pulled out, place the disc tray ("K" is on the upper side) again, then retry printing. Place the printable disc properly referring to [Placing a Printable Disc](#).

If the disc tray is still jammed, check if there is a problem with the printable disc.

■ [Disc Tray Does Not Feed Properly](#)



Printing Stops Before It Is Completed



Check1 Is the disc tray guide opened while printing on paper?

Close the disc tray guide and press the **RESUME/CANCEL** button on the printer.

Check2 Is the paper loaded?

Make sure that paper is loaded.

If the printer has run out of paper, load paper.

Check3 Do the printing documents have lots of photographs or illustrations?

As printing large data such as photos or graphics takes time for the printer and the computer to process, the printer may appear to have stopped operating.

In addition, when printing data that uses a large amount of ink continuously on plain paper, the printer may pause temporarily. In either case, wait until the process is complete.

▶▶▶ Note

- If you are printing a document with a large printing area or printing multiple copies of a document, printing may pause to allow the ink to dry.

Check4 Has the printer been printing continuously for a long period?

If the printer has been printing continuously for a long time, the print head or other parts around it may overheat. The printer may stop printing at a line break for a period of time and then resume printing.

In this case, wait for a while without operation. If the printing still does not resume, interrupt your print session at a convenient time and turn the printer off for at least 15 minutes.

⚠ Caution

- The print head and the surrounding area can become extremely hot inside the printer. Never touch the print head or nearby components.

Problems with the Printer

- ▶ **The Printer Cannot Be Powered On**
- ▶ **The Printer Turns Off Unintentionally**
- ▶ **Cannot Connect to Computer with a USB Cable Properly**
- ▶ **Cannot Communicate with the Printer with USB Connection**
- ▶ **Print Head Holder Does Not Move to the Position for Replacing**
- ▶ **The Printer Is Vibrating/The Printer Is Making an Operation Noise Even When the Printer Is Not in Use**



The Printer Cannot Be Powered On



Check1 Press the **ON** button.

Check2 Make sure that the power plug is securely plugged into the power cord connector of the printer, then turn it back on.

Check3 Unplug the printer from the power supply, then plug the printer back in and turn the printer back on after leaving it for at least 5 minutes.

If the problem is not resolved, contact the service center.



The Printer Turns Off Unintentionally



Check Disable the setting to turn the unit off automatically.

The printer turns off automatically according to the elapsed time you specified if the setting to turn the unit off automatically is enabled.

If you do not want the printer to turn off automatically, open Canon IJ Printer Utility, select **Power Settings** in the pop-up menu, then select **Disable** for **Auto Power Off** on **Auto Power**.

Cannot Connect to Computer with a USB Cable Properly

Printing Speed Is Slow/Hi-Speed USB Connection Does Not Work

If your system environment is not fully compatible with Hi-Speed USB, the printer will operate at a lower speed provided under USB 1.1. In this case, the printer operates properly but printing speed may slow down due to communication speed.

Check Check the following to make sure that your system environment supports Hi-Speed USB connection.

- Does the USB port on your computer support Hi-Speed USB connection?
- Does the USB cable or the USB hub support Hi-Speed USB connection?

Be sure to use a certified Hi-Speed USB cable. We recommend that the cable is no longer than around 10 feet / 3 meters.

- Does the operating system of your computer support Hi-Speed USB connection?
Obtain and install the latest update for your computer.
- Does the Hi-Speed USB driver operate properly?

Obtain the latest version of the Hi-Speed USB driver compatible with your hardware and reinstall it on your computer.

Important

- For details on Hi-Speed USB of your system environment, contact the manufacturer of your computer, USB cable, or USB hub.



Cannot Communicate with the Printer with USB Connection



Check1 Make sure that the printer is turned on.

Check2 Make sure that the USB cable is connected properly.

See [Connecting the Printer to the Computer Using a USB Cable](#) to connect the USB cable properly.

Check3 Do not start up IJ Network Tool while printing.

Check4 Do not print while IJ Network Tool is running.



Print Head Holder Does Not Move to the Position for Replacing



Check1 Is the **POWER** lamp off?

Check if the **POWER** lamp is lit.

The print head holder will not move unless the power is on. If the **POWER** lamp is off, close the top cover and turn the printer on.

While the **POWER** lamp is flashing, the printer is initializing. Wait until the **POWER** lamp stops flashing and remains lit, open the top cover again, then press the **RESUME/CANCEL** button.

Check2 Is the **Alarm** lamp flashing?

Close the top cover, confirm the number of times the **Alarm** lamp is flashing. After that, take the appropriate action to resolve the error, reopen the top cover, then press the **RESUME/CANCEL** button. For details on how to resolve the error, see [If an Error Occurs](#).

Check3 Has the top cover been left open for 10 minutes or longer?

If the top cover is left open for more than 10 minutes, the print head holder moves to the position to protect it to prevent the print head from drying out. Close and reopen the top cover, then press the **RESUME/CANCEL** button to return the print head holder to the position for replacing.

Check4 Has the printer been printing continuously for a long period?

Close the top cover, reopen it after a while, then press the **RESUME/CANCEL** button.

If the printer has been printing continuously for a long time, the print head holder may not move to the position for replacing since the print head may overheat.

Note

- Opening the top cover while printing moves the print head holder to the position to protect it. After printing finishes, close the top cover, reopen it, then press the **RESUME/CANCEL** button.



The Printer Is Vibrating/The Printer Is Making an Operation Noise Even When the Printer Is Not in Use



Check Wait until the printer stops vibrating.

When the **POWER** lamp flashes and the printer vibrates, the printer is shaking the ink tanks.

To equalize the density of ink, the printer is set to automatic ink quality maintenance for stirring ink automatically on a regular basis. While the ink is stirred, the printer vibrates and makes noise. This is not a malfunction, so wait until the **POWER** lamp stops flashing and stays lit, and the printer stops vibrating.

Do not open the top cover while the printer is operating (the **POWER** lamp is flashing).

If this vibration and noise is bothersome, such as when using the printer late at night, automatic ink quality maintenance can be disabled by using the printer driver.

If automatic ink quality maintenance has been disabled, be sure to follow the procedure below to enable automatic ink quality maintenance again.

»» Important

- Enabling automatic ink quality maintenance is recommended. Failure to perform the ink quality maintenance about once a week may affect print quality.

1. Make sure that the printer is turned on.
2. Open the Canon IJ Printer Utility.
 - [Opening the Canon IJ Printer Utility](#)
3. Select **Custom Settings** in the pop-up menu.
4. Select the **Execute ink quality maintenance automatically** check box, then click **Apply**.
5. Confirm the message and click **OK**.

Problems with Installation/Downloading

- ▶ **Cannot Install the Printer Driver**
- ▶ **Uninstalling IJ Network Tool**



Cannot Install the Printer Driver



Download the driver from the support page of our website, then reinstall it.



Uninstalling IJ Network Tool



Follow the procedure below to uninstall IJ Network Tool from your computer.

▶▶ Important

- Even if IJ Network Tool is uninstalled, you can print over network. However, you cannot change the network settings over network.

1. Select **Applications** from the **Go** menu of Finder, double-click **Canon Utilities > IJ Network Tool**, drag the **Canon IJ Network Tool** icon into the **Trash**.

2. Restart the computer.

Empty the **Trash** and restart your computer.

▶▶ Note

- To reinstall IJ Network Tool, uninstall IJ Network Tool, then install it again from our website.

About Errors/Messages Displayed

- ▶ **If an Error Occurs**
- ▶ **A Message Is Displayed**
- ▶ **Error Message Appears on a PictBridge Compliant Device**

If an Error Occurs

When an error occurs in printing such as the printer is out of paper or paper is jammed, a troubleshooting message is displayed automatically. Take the appropriate action described in the message.

When an error occurs, the **Alarm** lamp flashes and a Support Code (error number) is displayed on the computer screen. For some errors, the **POWER** lamp and the **Alarm** lamp flashes alternately. Check the status of the lamps and the message, then take the appropriate action to resolve the error.

Support Code Corresponding to the Number of Flashes of the Alarm Lamp

Example of 2 times flashing:



(A) Flashes

(B) Goes off

Number of flashes	Cause	Support Code
2 flashes	There is no paper in the rear tray.	1000
	There is no disc tray.	1001
	Printable disc (BD/DVD/CD, etc.) is not set.	1002
	There is no paper in the manual feed tray.	1006
3 flashes	The paper output tray is closed.	1250
	The manual feed tray is in the paper jam clearing position.	1261
	The feed slot cover is open.	1270
	Paper is jammed in the paper output slot, in the rear tray, or in the manual feed tray.	1300
	Paper is loaded in the manual feed tray when you start printing on a printable disc.	1308
4 flashes	Ink may have run out (The lamp on the ink tank flashes).	1600
	The ink tank is not installed.	1660
5 flashes	The print head is not installed.	1401
	The print head may be damaged.	1403 , 1405

6 flashes	The disc tray guide is closed.	1850
	The disc tray guide is open.	1851
	The disc tray guide has been closed.	1855
	The disc tray guide has been opened.	1856
	To print on specified paper, you need to open the disc tray guide.	1859
	To continue printing, you need to close the disc tray guide.	185A
7 flashes	Some ink tanks are not installed in the correct position. (The lamp on the ink tank flashes.)	1680
	More than one ink tanks of the same color are installed. (The lamp on the ink tank flashes.)	1681
8 flashes	The ink absorber is almost full.	1700 , 1701
9 flashes	The device incompatible with the printer is connected.	2001
11 flashes	The Page Size setting does not match the size of the paper loaded in the printer.	1062
	Automatic Print Head Alignment failed.	2500
	Cannot perform printing with the current print setting.	4103
12 flashes	Ink tank replacement is complete.	1350
	The specified data cannot be printed.	4100
14 flashes	The ink tank cannot be recognized.	1684
	Appropriate ink tank is not installed.	1750
15 flashes	The ink tank cannot be recognized.	1410 , 1411 , 1412 , 1413 , 1414 , 1415 , 1416 , 1417 , 1418 , 1419
17 flashes	Printer detected ink out condition (The lamp on the ink tank flashes).	1698
18 flashes	Printer detected ink out condition. (The lamp on the ink tank flashes.)	1699
19 flashes	An unsupported USB hub is connected.	2002
21 flashes	The printer cannot detect the paper size.	2103

Support Code Corresponding to the Number of Alternate Flashes of the POWER Lamp and the Alarm Lamp

Example of 2 times flashing:

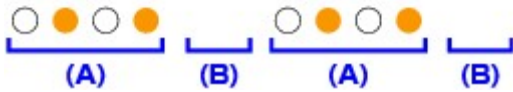

(A) Flashes

(B) Goes off

Number of flashes	Cause	Support Code
2 flashes	Printer error has occurred.	5100
7 flashes	Printer error has occurred.	5B00 , 5B01
10 flashes	An error requiring you to contact the service center has occurred.	B200
Other cases than above	Printer error has occurred.	5110 , 5200 , 5250 , 5400 , 5700 , 5C00 , 5C20 , 6000 , 6010 , 6500 , 6502 , 6700 , 6800 , 6801 , 6900 , 6901 , 6902 , 6910 , 6911 , 6920 , 6921 , 6930 , 6931 , 6932 , 6933 , 6940 , 6941 , 6942 , 6943 , 6944 , 6945 , 6946 , 6A00 , 6B00 , 8200 , 9000 , 9400 , B400

- When a Support Code and a message are displayed on the computer screen:

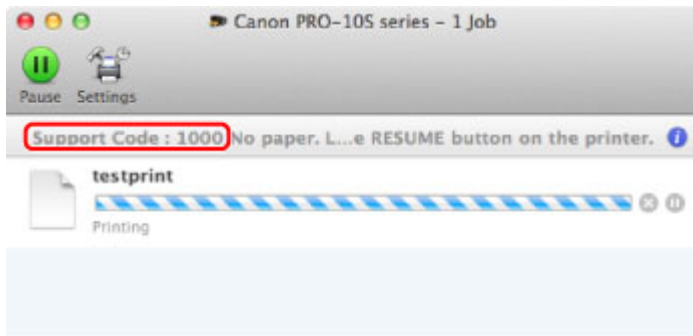

* The screen differs depending on the OS you are using.

▶▶▶ Note

- You can confirm the actions against errors with Support Codes on your computer by searching a Support Code.

■ [Click Here to Search](#)

For details on how to resolve errors without Support Codes, see [A Message Is Displayed](#).

A Message Is Displayed

This section describes some of the errors or messages.

»» Note

- A Support Code (error number) is displayed on the computer for some error or message. For details on errors with Support Codes, refer to [List of Support Code for Error](#).

Q The Inkjet Printer/Scanner/Fax Extended Survey Program Icon Appears

A

If the Inkjet Printer/Scanner/Fax Extended Survey Program is installed, the printer and application software usage information is scheduled to be sent every month for about ten years. The **Inkjet Printer/Scanner/Fax Extended Survey Program** icon appears in the Dock when it is time to send the printer usage information.

Read the instructions on the screen after clicking the icon, then follow the procedure below.

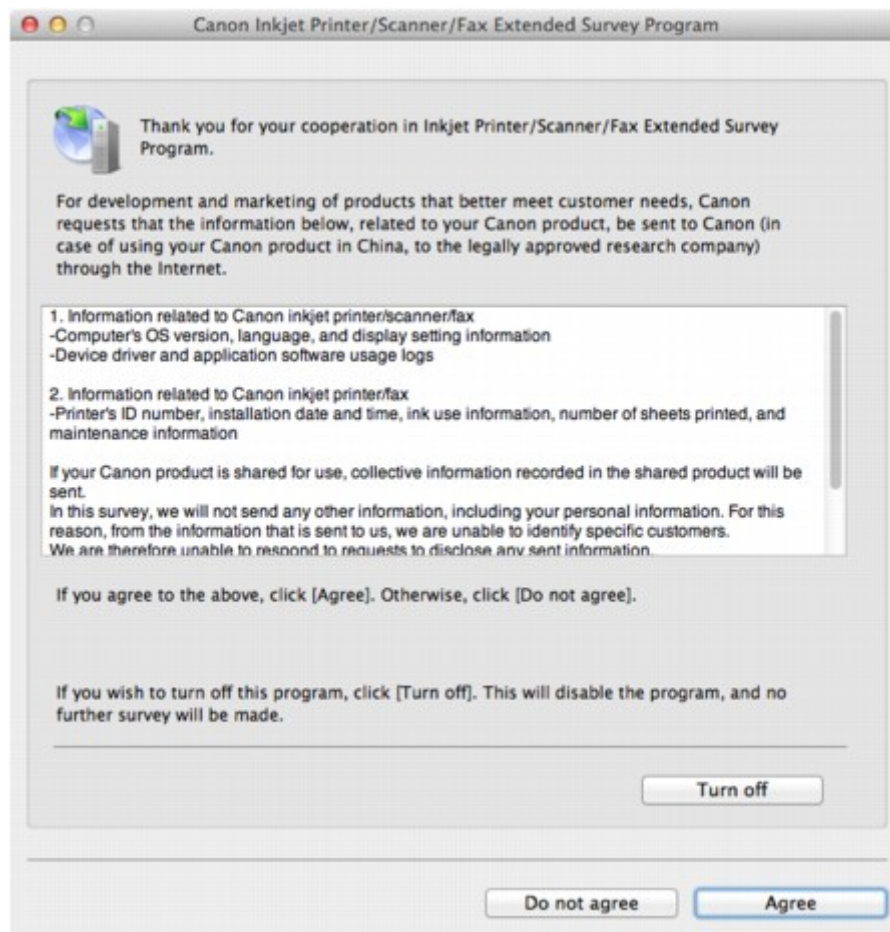

- **If you agree to participate in the survey program:**

Click **Agree**, then follow the on-screen instructions. The printer usage information will be sent via the Internet. If you have followed the on-screen instructions, the information will be sent automatically from the second time onward and the confirmation screen will not be displayed again.

►► Note

- If you deselect the **Send automatically from the next time** check box, the information will not be sent automatically from the second time onward and the **Inkjet Printer/Scanner/Fax Extended Survey Program** icon will appear in the Dock at the time of the next survey.

- **If you do not agree to participate in the survey program:**

Click **Do not agree**. The confirmation screen will be closed, and the survey at that time is skipped. The confirmation screen will be displayed again one month later.

- **To stop sending the information:**

Click **Turn off**. The Inkjet Printer/Scanner/Fax Extended Survey Program is stopped, and the information will not be sent. To resume the survey, see [Changing the setting](#).

- **To uninstall the Inkjet Printer/Scanner/Fax Extended Survey Program:**

1. Stop the Inkjet Printer/Scanner/Fax Extended Survey Program.

- **Changing the setting:**

2. Select **Applications** from the **Go** menu of Finder, and double-click the **Canon Utilities** folder, then the **Inkjet Extended Survey Program** folder.
3. Place the **Canon Inkjet Printer/Scanner/Fax Extended Survey Program.app** file into the **Trash**.
4. Restart the computer.
Empty the **Trash** and restart your computer.

- **Changing the setting:**

To display the confirmation screen every time the printer usage information is sent or to resume surveying, follow the procedure below.

1. Select **Applications** from the **Go** menu of Finder, and double-click the **Canon Utilities** folder, then the **Inkjet Extended Survey Program** folder.
2. Double-click the **Canon Inkjet Printer/Scanner/Fax Extended Survey Program** icon.

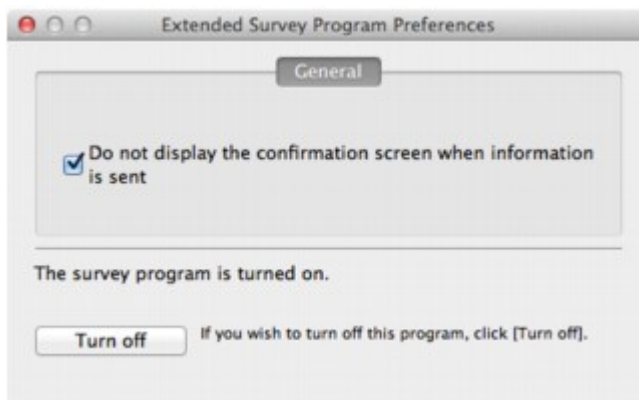

- **Do not display the confirmation screen when information is sent:**

If the check box is selected, the information will be sent automatically.

If the check box is not selected, the **Inkjet Printer/Scanner/Fax Extended Survey Program** icon will appear in the Dock at the time of the next survey. Click the icon, then follow the on-screen instructions.

- **Turn off/Turn on button:**

Click the **Turn off** button to stop the Inkjet Printer/Scanner/Fax Extended Survey Program.

Click the **Turn on** button to restart the Inkjet Printer/Scanner/Fax Extended Survey Program.



Error Message Appears on a PictBridge Compliant Device



The following are the possible errors that may occur when printing directly from a PictBridge compliant device and the countermeasures to clear them.

▶▶▶ Note

- This section describes errors that are indicated on Canon-brand PictBridge compliant devices. The error messages and operations may vary depending on the device you are using. For errors on non-Canon PictBridge compliant devices, check the status of the **Alarm** lamp and take the appropriate action to clear the error. For details, see [If an Error Occurs](#).
- For the errors indicated on the PictBridge compliant device and their solution, also refer to the instruction manual of the device. For other troubles on the device, contact the manufacturer.

Error Message on the PictBridge Compliant Device	Action
"Printer in use"	<ul style="list-style-type: none"> • If the printer is printing from the computer or warming up, wait until the job ends. When it is ready, the printer starts printing automatically. • If you replace an ink tank while printing from a PictBridge compliant device, press the RESUME/CANCEL button on the printer to clear the error, then resume printing.
"No paper"	<p>Load paper, and select Continue* in the display on your PictBridge compliant device.</p> <p>* To resume printing, you can also press the RESUME/CANCEL button on the printer instead of selecting Continue on the device.</p>
"Paper Error"	<p>Check the number of how many the Alarm lamp flashes and take the appropriate action to resolve the error.</p> <p>■ If an Error Occurs</p>
"Paper jam"	<p>Select Stop in the display on your PictBridge compliant device to stop printing.</p> <p>Remove the jammed paper, load new paper, press the RESUME/CANCEL button on the printer, then try printing again.</p>
"Printer cover open"	<p>Close the top cover on the printer.</p>
"No print head"	<p>The print head is not installed or may be damaged.</p> <p>Contact the service center.</p>
"Waste tank full"/"Ink absorber full"	<p>The ink absorber is nearly full.</p> <p>Check the number of how many the Alarm lamp flashes and take the appropriate action to resolve the error.</p> <p>■ If an Error Occurs</p>
"No ink"/"Ink cassette error"	<p>Check the number of how many the Alarm lamp flashes and take the appropriate action to resolve the error.</p>

	<p>■ If an Error Occurs</p>
"Ink Error"	<p>An ink tank that was once empty is installed.</p> <p>When the Alarm lamp flashes 18 times, refer to 1699 to resolve the error.</p>
"Hardware Error"	<p>The ink tank cannot be recognized. (The lamp on the ink tank is off.)</p> <p>Replace the ink tank.</p> <p>■ Replacing an Ink Tank</p>
"Printer error"	<p>An error requiring servicing may have occurred.</p> <p>Turn off the printer, and unplug the power cord of the printer from the power supply.</p> <p>Plug the printer back in and turn the printer back on.</p> <p>If the problem is not resolved, contact the service center.</p>

If You Cannot Resolve the Problem

If you cannot resolve the problem with any of the workarounds in this chapter, please contact the seller of the printer or the service center.

Canon support staff are trained to be able to provide technical support to satisfy customers.

Caution

- If the printer emits any unusual sound, smoke, or odor, turn it off immediately. Unplug the power cord from the outlet and contact the seller or the service center. Never attempt to repair or disassemble the printer yourself.
- Attempts by customers to repair or take apart the printer will invalidate any warranty regardless of whether the warranty has expired.

Before contacting the service center, confirm the following:

- Product name:
 - * Your printer's name is located on the front cover of the setup manual.
- Serial number: please refer to the setup manual
- Details of the problem
- What you tried to solve the problem, and what happened

List of Support Code for Error

The support code appears on the computer screen when an error occurs.

"Support Code" means the error number and appears with an error message.

When an error occurs, check the support code displayed on the computer screen and take the appropriate action.

Support Code Appears on the Computer Screen

- **1000 to 1ZZZ**

[1000](#) [1001](#) [1002](#) [1006](#) [1062](#) [1200](#)

[1250](#) [1261](#) [1270](#) [1300](#) [1308](#) [1350](#)

[1351](#) [1401](#) [1403](#) [1405](#) [1410](#) [1411](#)

[1412](#) [1413](#) [1414](#) [1415](#) [1416](#) [1417](#)

[1418](#) [1419](#) [1600](#) [1660](#) [1680](#) [1681](#)

[1684](#) [1698](#) [1699](#) [1700](#) [1701](#) [1750](#)

[1850](#) [1851](#) [1855](#) [1856](#) [1859](#) [185A](#)

- **2000 to 2ZZZ**

[2001](#) [2002](#) [2103](#) [2500](#)

- **4000 to 4ZZZ**

[4100](#) [4103](#)

- **5000 to 5ZZZ**

[5100](#) [5110](#) [5200](#) [5250](#) [5400](#) [5700](#)

[5B00](#) [5B01](#) [5C00](#) [5C20](#)

- **6000 to 6ZZZ**

[6000](#) [6010](#) [6500](#) [6502](#) [6700](#) [6800](#)

[6801](#) [6900](#) [6901](#) [6902](#) [6910](#) [6911](#)

[6920](#) [6921](#) [6930](#) [6931](#) [6932](#) [6933](#)

[6940](#) [6941](#) [6942](#) [6943](#) [6944](#) [6945](#)

[6946](#) [6A00](#) [6B00](#)

- **8000 to 8ZZZ**

[8200](#)

- **9000 to 9ZZZ**

[9000](#) [9400](#)

- **A000 to ZZZZ**

[B200](#) [B400](#)

About the support code for paper jam, you can also refer to [List of Support Code for Error \(When Paper Is Jammed\)](#).

List of Support Code for Error (When Paper Is Jammed)

If the paper is jammed, remove it following the procedure appropriate for each case.

- If you can see the jammed paper at the paper output slot, the rear tray, or the manual feed tray:

- [1300](#)

- If the paper tears and you cannot remove it from the paper output slot, from the rear tray, or from the manual feed tray:

- [Paper Is Jammed inside the Printer](#)

- Cases other than above:

- [In Other Cases](#)

1300

Cause

Paper is jammed in the paper output slot, in the rear tray, or in the manual feed tray.

Action

Remove the jammed paper depending on the paper source.

■ [If the paper loaded in the rear tray is jammed:](#)

■ [If the paper loaded in the manual feed tray is jammed:](#)

- **If the paper loaded in the rear tray is jammed:**

1. Pull the paper out slowly, either from the paper output slot or from the rear tray, whichever is easier.

Hold the paper with your hands, then pull the paper out slowly not to tear it.

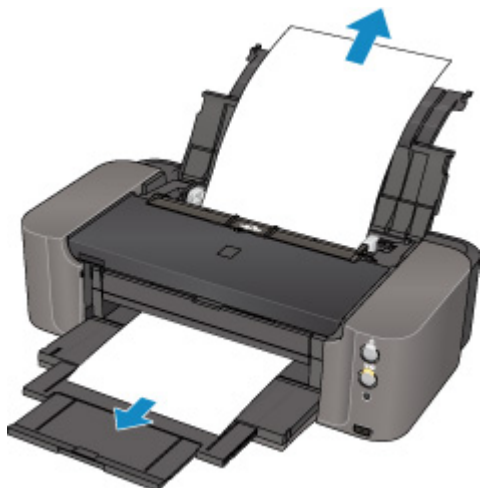

▶▶▶ Note

- If you cannot pull the paper out, turn the printer off and turn it back on. The paper may be ejected automatically.
- If you need to turn off the printer to remove jammed paper during printing, press the **RESUME/CANCEL** button to cancel print jobs before turning off the printer.
- If the paper tears and you cannot remove the jammed paper from the paper output slot or the rear tray, remove the paper from inside the printer.

■ [Paper Is Jammed inside the Printer](#)

2. Reload the paper, and press the **RESUME/CANCEL** button on the printer.

The printer resumes printing. Reprint the page you were printing if it was not printed properly due to the paper jam.

If you turned off the printer in step 1, all print jobs in the queue are canceled. Reprint if necessary.

▶▶▶ Note

- When reloading the paper, make sure that you are using suitable paper for printing and are loading it correctly.

- We recommend you use paper other than A5 sized one to print documents with photos or graphics; otherwise, the printout may curl and cause paper exit jams.

• **If the paper loaded in the manual feed tray is jammed:**

1. Press the **Paper Jam Clearing** button then set the manual feed tray to the paper jam clearing position.

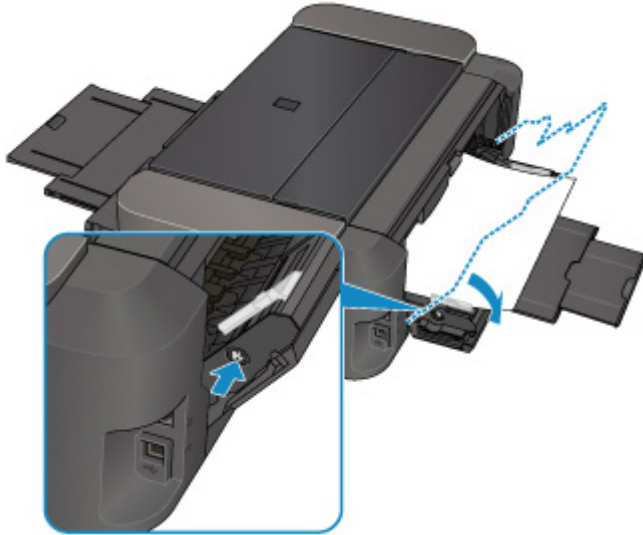

2. Pull the paper out slowly, either from the paper output slot or from the manual feed tray, whichever is easier.

Hold the paper with your hands, then pull the paper out slowly not to tear it.

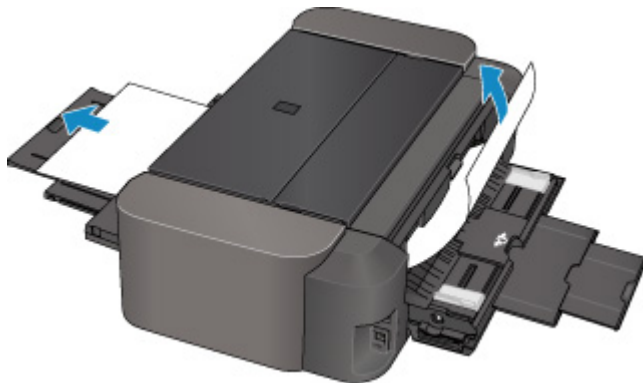

▶▶▶ **Note**

- If you cannot pull the paper out, turn the printer off and turn it back on. The paper may be ejected automatically.
- If the paper tears and you cannot remove the jammed paper from the paper output slot or the manual feed tray, remove the paper from inside the printer.

■ [Paper Is Jammed inside the Printer](#)

3. Return the manual feed tray to the original position.



4. Reload the paper, and press the **RESUME/CANCEL** button on the printer.

The printer resumes printing. Reprint the page you were printing if it was not printed properly due to the paper jam.

If you turned off the printer in step 2, all print jobs in the queue are canceled. Reprint if necessary.

▶▶ Note

- When reloading the paper, make sure that you are using suitable paper for printing and are loading it correctly.

If you cannot remove the paper or the paper tears inside the printer, or if the paper jam error continues after removing the paper, contact the service center.

Paper Is Jammed inside the Printer

If the jammed paper tears and you cannot remove the paper either from the paper output slot, from the rear tray, or from the manual feed tray, or if the jammed paper remains inside the printer, remove the paper following the procedure below.

▶▶▶ Note

- If you need to turn off the printer to remove jammed paper during printing, press the **RESUME/CANCEL** button to cancel print jobs before turning off the printer.

1. Turn off the printer, and unplug the power cord of the printer from the power supply.
2. Open the top cover and the disc tray guide.

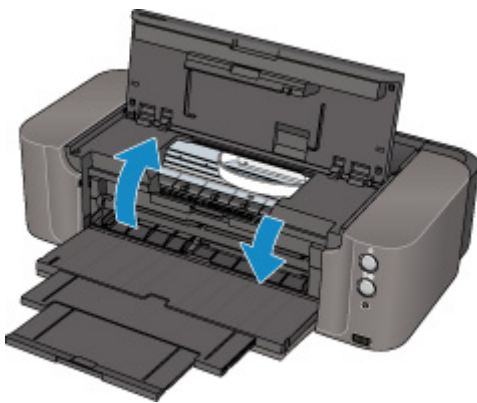

▶▶▶ Important

- Do not touch the clear film (A) or the white belt (B).

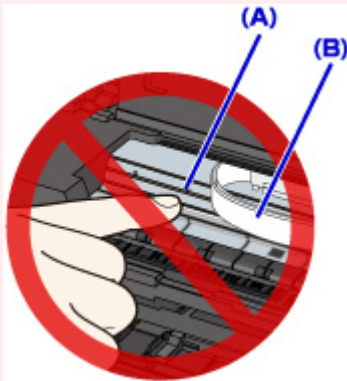

If the paper or your hands touch these parts and blot or scratch them, the printer can be damaged.

3. Make sure that the jammed paper is not under the print head holder.

If the jammed paper is under the print head holder, move the print head holder to the right edge or the left edge whichever is easier to remove the paper.

When you move the print head holder, hold the top of the print head holder and slide it slowly to the right edge or the left edge.

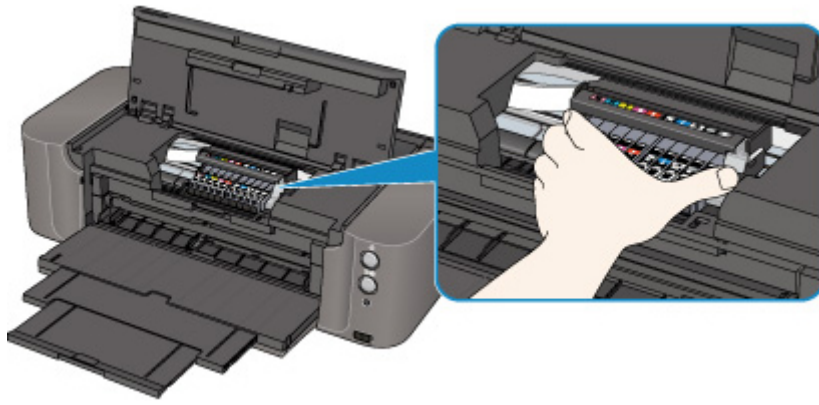

4. Hold the jammed paper with your hands.

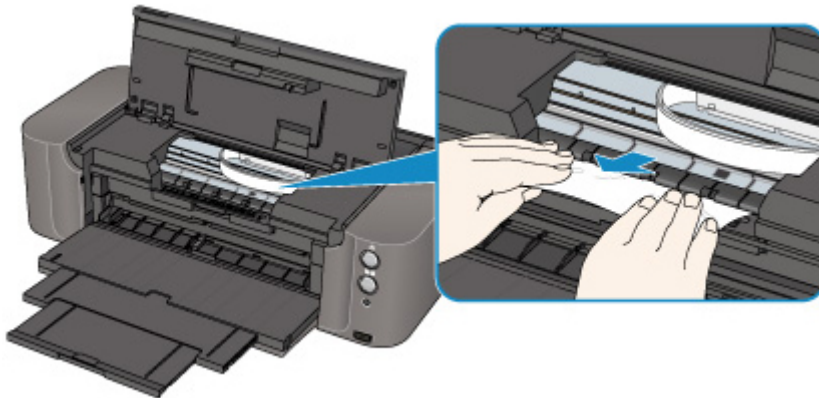

If the paper is rolled up, pull it out.

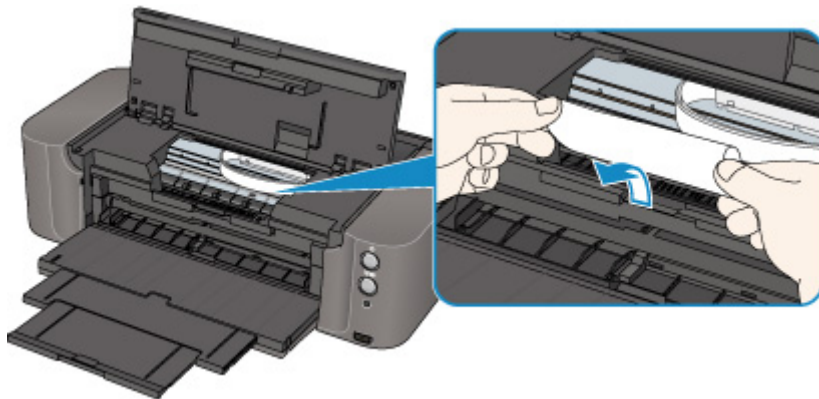

5. Pull the paper slowly not to tear it, then pull the paper out.

Keep an angle of the paper about 45 degrees and pull it slowly.

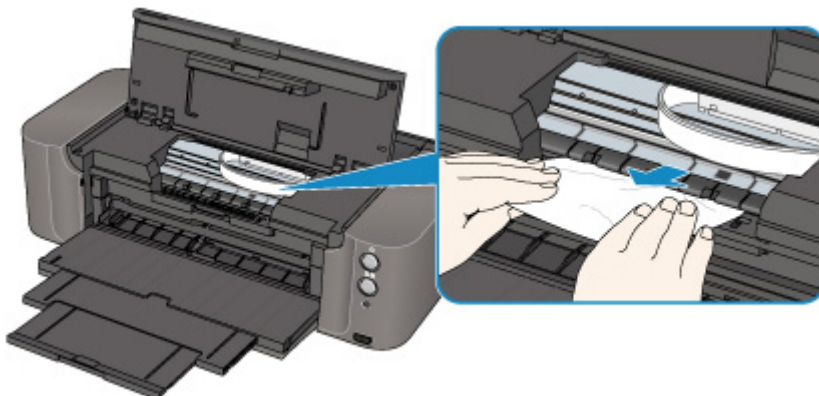

6. Make sure that all the jammed paper is removed.

If the paper is torn, a piece of paper may remain inside the printer. Check the following and remove the piece of paper if it remains.

- Does the piece of paper remain under the print head holder?
- Does the little piece of paper remain inside the printer?
- Does the piece of paper remain in the right side or the left side space (C) inside the printer?

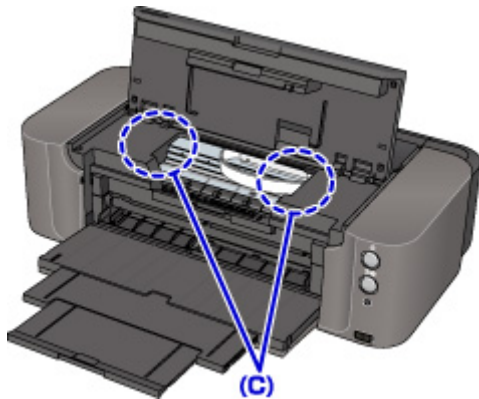

7. Close the disc tray guide and the top cover.

All print jobs in the queue are canceled. Reprint if necessary.

▶▶▶ Note

- When reloading the paper, make sure that you are using suitable paper for printing and are loading it correctly. If the message about paper jam is displayed on the computer screen when you resume printing after removing all the jammed paper, a piece of paper may remain inside the printer. In this case, confirm that no piece of paper remains inside the printer.

If you cannot remove the paper or the paper tears inside the printer, or if the paper jam error continues after removing the paper, contact the service center.

In Other Cases

Make sure of the following:

Check1 Are there any foreign objects around the paper output slot?

Check2 Are there any foreign objects in the rear tray or the manual feed tray?



If there are any foreign objects in the rear tray or the manual feed tray, be sure to turn off the printer, unplug it from the power supply, then remove the foreign object.

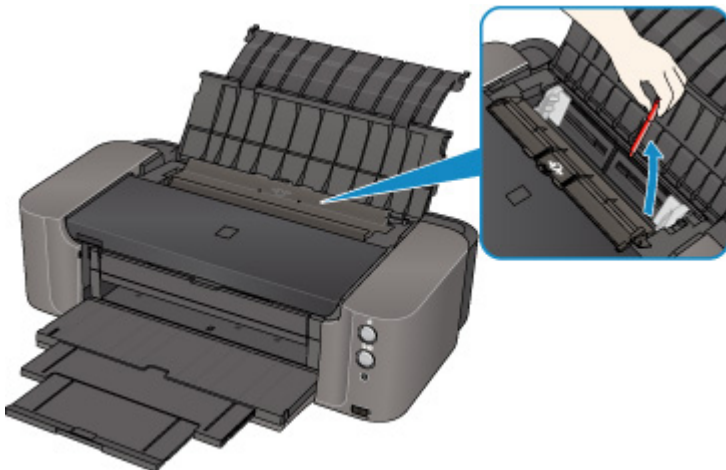

▶▶▶ Note

- If the feed slot cover is opened, close it slowly.

Check3 Is the paper curled?

Load the paper after correcting its curl.

1000

Cause

Possible causes include the following.

- There is no paper in the rear tray.
- Paper is not loaded properly.

Action

Take the corresponding actions below.

- Load paper in the rear tray.
- Align the paper guides with the both edges of the paper when you load paper.

After carrying out the above measures, press the printer's **RESUME/CANCEL** button to dismiss the error.

►► Important

- Be sure to close the feed slot cover after loading paper in the rear tray. If the feed slot cover is open, paper cannot be fed.

1001

Cause

There is no disc tray.

Action

When printing on printable discs (BD/DVD/CD, etc.), use the disc tray supplied with this printer ("K" is on the upper side). Place a printable disc on the disc tray, attach the disc tray to the printer, then press the printer's **RESUME/CANCEL** button.

1002

Cause

Printable disc (BD/DVD/CD, etc.) is not set.

Action

When printing on printable discs, use the disc tray supplied with this printer ("K" is on the upper side).

Place a printable disc on the disc tray, attach the disc tray to the printer, then press the printer's **RESUME/CANCEL** button.

1006

Cause

Possible causes include the following.

- There is no paper in the manual feed tray.
- Paper is not loaded properly.

Action

Take the corresponding actions below.

- Load a sheet of paper in the manual feed tray.
- Align the paper guides with the both edges of the paper when you load paper.

After carrying out the above measures, press the printer's **RESUME/CANCEL** button to dismiss the error.

▶▶ Note

- To continue printing from the manual feed tray, wait until printing is completed, then load the next sheet.

1062

Cause

The Page Size setting does not match the size of the paper loaded in the printer.

Action

Press the printer's **RESUME/CANCEL** button to clear the error.

Then, take the corresponding actions below.

- In Windows:

Then check the **Page Size** setting in the **Page Setup** sheet in the printer driver and load paper that is the same size as the setting and try printing again.

If this error occurs even you load paper of the same size as the setting, set the printer not to detect the width of the paper using the printer driver.

To set the printer driver not to detect the width of the paper, open the printer driver setup window, and in **Custom Settings** under the **Maintenance** sheet, clear the **Detect paper width** check box, and then click **OK**.

* Select the **Detect paper width** check box again once printing is complete, and then click **OK**.

- In Mac OS:

Then check the **Paper Size** setting in the Page Setup dialog and load paper that is the same size as the setting and try printing again.

If this error occurs even you load paper of the same size as the setting, set the printer not to detect the width of the paper using the Canon IJ Printer Utility.

To set the printer not to detect the width of the paper, open the Canon IJ Printer Utility, select **Custom Settings** in the pop-up menu, clear the **Detect paper width** check box, and then click **Apply**.

* Select the **Detect paper width** check box again once printing is complete, and then click **Apply**.

▶▶ Note

- When printing with AirPrint, you can set the printer not to detect the width of the paper using the Remote UI.

1200

Cause

The top cover is open.

Action

Close the top cover and wait for a while.

Do not close it while you are replacing an ink tank.

1250

Cause

The paper output tray is closed.

Action

Open the paper output tray to resume printing.

1261

Cause

The manual feed tray is in the paper jam clearing position.

Action

Return the manual feed tray to the paper feed position, then press the printer's **RESUME/CANCEL** button.

1270

Cause

The feed slot cover is open.

Action

Close the feed slot cover slowly then press the printer's **RESUME/CANCEL** button.

1308

Cause

Paper is loaded in the manual feed tray when you start printing on a printable disc.

Action

Remove the paper from the manual feed tray, then press the printer's **RESUME/CANCEL** button.

1350

Cause

Ink tank replacement is complete.

Action

Press the printer's **RESUME/CANCEL** button to continue printing.

1351

Cause

When the ink tank replacement is required, the top cover has been opened.

Action

Check the following precautions for ink tank replacement.

- Prepare a new ink tank before you start replacing one.
- Replace the ink tank quickly so as not to leave the printer without an ink tank. The printer may be damaged if it is left without an ink tank, causing a problem such as clogging due to dried ink.
- When starting the ink tank replacement, press the printer's **RESUME/CANCEL** button with the top cover open.

1401

Cause

The print head is not installed.

Action

Install the print head.

If the print head is already installed, remove the print head once and then reinstall it.

If the error is still not resolved, the print head may be damaged. Contact the service center.

1403

Cause

The print head may be damaged.

Action

Contact the service center.

1405

Cause

The print head may be damaged.

Action

Contact the service center.

1410

Cause

The ink tank cannot be recognized.

Action

Open the top cover and replace the ink tank which lamp is off.

1411

Cause

The ink tank cannot be recognized.

Action

Open the top cover and replace the ink tank which lamp is off.

1412

Cause

The ink tank cannot be recognized.

Action

Open the top cover and replace the ink tank which lamp is off.

1413

Cause

The ink tank cannot be recognized.

Action

Open the top cover and replace the ink tank which lamp is off.

1414

Cause

The ink tank cannot be recognized.

Action

Open the top cover and replace the ink tank which lamp is off.

1415

Cause

The ink tank cannot be recognized.

Action

Open the top cover and replace the ink tank which lamp is off.

1416

Cause

The ink tank cannot be recognized.

Action

Open the top cover and replace the ink tank which lamp is off.

1417

Cause

The ink tank cannot be recognized.

Action

Open the top cover and replace the ink tank which lamp is off.

1418

Cause

The ink tank cannot be recognized.

Action

Open the top cover and replace the ink tank which lamp is off.

1419

Cause

The ink tank cannot be recognized.

Action

Open the top cover and replace the ink tank which lamp is off.

1600

Cause

Ink may have run out (The lamp on the ink tank flashes).

Action

If printing is in progress, you are recommended to stop printing, replace the ink tank, and then print again.

If printing is in progress and you want to continue printing, press the printer's **RESUME/CANCEL** button with the ink tank installed. Then printing can continue under the ink out condition. Replace the empty ink tank immediately after the printing. The printer may be damaged if printing is continued under the ink out condition.

▶▶ Note

- If multiple ink lamps are flashing, check the status of each ink tank.

1660

Cause

The ink tank is not installed.

Action

Install the ink tank.

1680

Cause

Some ink tanks are not installed in the correct position. (The lamp on the ink tank flashes.)

Action

Confirm that the ink tanks are installed in the appropriate positions.

1681

Cause

More than one ink tanks of the same color are installed. (The lamp on the ink tank flashes.)

Action

Confirm that the ink tanks are installed in the appropriate positions.

1684

Cause

The ink tank cannot be recognized.

Action

Printing cannot be executed because the ink tank may not be installed properly or may not be compatible with this printer.

Install the appropriate ink tank.

If you want to cancel printing, press the printer's **RESUME/CANCEL** button.

1698

Cause

Printer detected ink out condition (The lamp on the ink tank flashes).

Action

If printing is in progress, stop printing, replace the ink tank, and then print again.

To avoid printing troubles such as the mixing of inks, this printer is designed to stop printing by flashing the **Alarm** lamp seventeen times when the remaining ink level in an ink tank goes under the amount of ink required to maintain both printer and print quality.

1699

Cause

Printer detected ink out condition (The lamp on the ink tank flashes).

Action

Stop printing, replace the ink tank, and then print again. Be sure to replace the empty ink tank before resuming printing.

An ink tank that was once empty is installed.

Printing under the ink out condition may cause the printing trouble such as the mixing of inks, or a printer malfunction.

If you want to continue printing, you need to release the function for detecting the remaining ink level. To release this function, press and hold the printer's **RESUME/CANCEL** button for at least 5 seconds, and then release it.*

* With this operation, releasing the function for detecting the remaining ink level is memorized. Please be advised that Canon shall not be liable for any malfunction or trouble which may be caused by continuation of printing or refilling of ink.

1700

Cause

The ink absorber is almost full.

Action

Press the printer's **RESUME/CANCEL** button to continue printing. Contact the service center.

1701

Cause

The ink absorber is almost full.

Action

Press the printer's **RESUME/CANCEL** button to continue printing. Contact the service center.

1750

Cause

Appropriate ink tank is not installed.

Action

Printing cannot be executed because the ink tank is not compatible with the printer.

Install the appropriate ink tank.

If you want to cancel printing, press the printer's **RESUME/CANCEL** button.

1850

Cause

The disc tray guide is closed.

Action

Open the disc tray guide, attach the disc tray properly, then press the printer's **RESUME/CANCEL** button.

1851

Cause

The disc tray guide is open.

Action

When printing other than disc label printing is started, close the disc tray guide.

Close the disc tray guide, then press the printer's **RESUME/CANCEL** button.

1855

Cause

The disc tray guide has been closed.

Action

Open the disc tray guide, then press the printer's **RESUME/CANCEL** button.

Do not open or close the disc tray guide while printing is in progress. Doing so may damage the printer.

1856

Cause

The disc tray guide has been opened.

Action

While printing other than disc label printing, close the disc tray guide.

Close the disc tray guide, then press the printer's **RESUME/CANCEL** button.

Do not open or close the disc tray guide while printing is in progress. Doing so may damage the printer.

1859

Cause

To print on specified paper, you need to open the disc tray guide.

Action

Open the disc tray guide.

Press the printer's **RESUME/CANCEL** button.

185A

Cause

To continue printing, you need to close the disc tray guide.

Action

Close the disc tray guide.

Press the printer's **RESUME/CANCEL** button. The printer resumes printing.

2001

Cause

The device incompatible with the printer is connected.

Action

Check the device connected to the printer. Printing photos directly is possible only with a PictBridge compliant device.

▶▶ Note

- A communication time out occurs if an operation takes too long or if it takes too much time to send data. This may cancel printing. In such cases, disconnect and reconnect the USB cable.

When printing from a PictBridge compliant device, depending on the model or brand of your device, you may have to select a PictBridge compliant print mode on the device before connecting it to the printer. You may also have to turn on your device or select Play mode manually after connecting the device to the printer. Perform necessary operations before connecting your device referring to its instruction manual.

If the error is not yet resolved, check if you can print another photograph.

2002

Cause

An unsupported USB hub is connected.

Action

If a PictBridge compliant device is connected to the printer through the USB hub, disconnect the hub from the printer.

Connect a PictBridge compliant device directly to the printer.

2103

Cause

The printer cannot detect the paper size.

Action

Press the printer's **RESUME/CANCEL** button to dismiss the error, then try to print again.

If this error still occurs even after printing again, set the printer not to detect the paper width by using the printer driver or Remote UI.

▶▶ Note

- Depending on the type of paper, the printer may not detect the paper width.
Additionally, if the top cover is opened while printing is in progress, the printer may not detect the paper width.

2500

Cause

The cause of following may have occurred the failure of Automatic Print Head Alignment.

- Print head nozzles are clogged.
- The paper of size other than A4 or Letter is loaded.
- The paper output slot is exposed to strong light.

Action

Press the printer's **RESUME/CANCEL** button to dismiss the error, then take the actions described below.

- Print the nozzle check pattern to check the status of the print head.
- Load two sheets of A4/Letter-sized plain paper in the rear tray and perform Automatic Print Head Alignment again.

For Automatic Print Head Alignment, always load paper in the rear tray.

- Adjust your operating environment and/or the position of the printer so that the paper output slot is not exposed directly to strong light.

After carrying out the above measures, if the problem continues after aligning the print head again, press the printer's **RESUME/CANCEL** button to dismiss the error, and then perform Manual Print Head Alignment.

4100

Cause

The specified data cannot be printed.

Action

When you print the contents on CREATIVE PARK PREMIUM, confirm the message on the computer screen, make sure that genuine Canon ink tanks are installed properly for all colors, then start printing again.

4103

Cause

Cannot perform printing with the current print settings.

Action

Press the printer's **RESUME/CANCEL** button, to cancel printing.

Then change the print settings and print again.

5100

Cause

Printer error has occurred.

Action

Cancel printing and turn off the printer.

Then confirm the following.

- Confirm that there are no materials (e.g. the protective material or jammed paper) that is preventing the print head holder from moving.

If any, remove the materials.

- Confirm that the ink tanks are installed properly.

Push an ink tank until it clicks into place.

After confirming the conditions above, turn on the printer again.

If the problem is not resolved, contact the service center.

►► Important

- When you clear the jammed paper or protective material that is preventing the print head holder from moving, be careful not to touch the clear film (A) or the white belt (B).

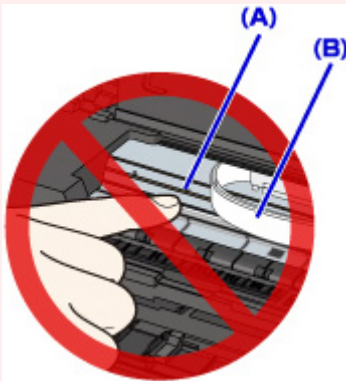

If the paper or your hands touch these parts and blot or scratch them, the printer can be damaged.

5110

Cause

Printer error has occurred.

Action

Turn off the printer, and unplug the power cord of the printer from the power supply.

Plug the printer back in and turn the printer back on.

If the problem is not resolved, contact the service center.

5200

Cause

Printer error has occurred.

Action

Turn off the printer, and unplug the power cord of the printer from the power supply.

Plug the printer back in and turn the printer back on.

If the problem is not resolved, contact the service center.

5250

Cause

Printer error has occurred.

Action

Turn off the printer, and unplug the power cord of the printer from the power supply.

Plug the printer back in and turn the printer back on.

If the problem is not resolved, contact the service center.

5400

Cause

Printer error has occurred.

Action

Turn off the printer, and unplug the power cord of the printer from the power supply.

Plug the printer back in and turn the printer back on.

If the problem is not resolved, contact the service center.

5700

Cause

Printer error has occurred.

Action

Turn off the printer, and unplug the power cord of the printer from the power supply.

Plug the printer back in and turn the printer back on.

If the problem is not resolved, contact the service center.

5B00

Cause

Printer error has occurred.

Action

Contact the service center.

5B01

Cause

Printer error has occurred.

Action

Contact the service center.

5C00

Cause

Printer error has occurred.

Action

Turn off the printer, and unplug the power cord of the printer from the power supply.

Plug the printer back in and turn the printer back on.

If the problem is not resolved, contact the service center.

5C20

Cause

Printer error has occurred.

Action

Turn off the printer, and unplug the power cord of the printer from the power supply.

Plug the printer back in and turn the printer back on.

If the problem is not resolved, contact the service center.

6000

Cause

Printer error has occurred.

Action

Turn off the printer, and unplug the power cord of the printer from the power supply.

Plug the printer back in and turn the printer back on.

If the problem is not resolved, contact the service center.

6010

Cause

Printer error has occurred.

Action

Turn off the printer, and unplug the power cord of the printer from the power supply.

Plug the printer back in and turn the printer back on.

If the problem is not resolved, contact the service center.

6500

Cause

Printer error has occurred.

Action

Turn off the printer, and unplug the power cord of the printer from the power supply.

Plug the printer back in and turn the printer back on.

If the problem is not resolved, contact the service center.

6502

Cause

Printer error has occurred.

Action

Turn off the printer, and unplug the power cord of the printer from the power supply.

Plug the printer back in and turn the printer back on.

If the problem is not resolved, contact the service center.

6700

Cause

Printer error has occurred.

Action

Turn off the printer, and unplug the power cord of the printer from the power supply.

Plug the printer back in and turn the printer back on.

If the problem is not resolved, contact the service center.

6800

Cause

Printer error has occurred.

Action

Turn off the printer, and unplug the power cord of the printer from the power supply.

Plug the printer back in and turn the printer back on.

If the problem is not resolved, contact the service center.

6801

Cause

Printer error has occurred.

Action

Turn off the printer, and unplug the power cord of the printer from the power supply.

Plug the printer back in and turn the printer back on.

If the problem is not resolved, contact the service center.

6900

Cause

Printer error has occurred.

Action

Turn off the printer, and unplug the power cord of the printer from the power supply.

Plug the printer back in and turn the printer back on.

If the problem is not resolved, contact the service center.

6901

Cause

Printer error has occurred.

Action

Turn off the printer, and unplug the power cord of the printer from the power supply.

Plug the printer back in and turn the printer back on.

If the problem is not resolved, contact the service center.

6902

Cause

Printer error has occurred.

Action

Turn off the printer, and unplug the power cord of the printer from the power supply.

Plug the printer back in and turn the printer back on.

If the problem is not resolved, contact the service center.

6910

Cause

Printer error has occurred.

Action

Turn off the printer, and unplug the power cord of the printer from the power supply.

Plug the printer back in and turn the printer back on.

If the problem is not resolved, contact the service center.

6911

Cause

Printer error has occurred.

Action

Turn off the printer, and unplug the power cord of the printer from the power supply.

Plug the printer back in and turn the printer back on.

If the problem is not resolved, contact the service center.

6920

Cause

Printer error has occurred.

Action

Turn off the printer, and unplug the power cord of the printer from the power supply.

Plug the printer back in and turn the printer back on.

If the problem is not resolved, contact the service center.

6921

Cause

Printer error has occurred.

Action

Turn off the printer, and unplug the power cord of the printer from the power supply.

Plug the printer back in and turn the printer back on.

If the problem is not resolved, contact the service center.

6930

Cause

Printer error has occurred.

Action

Turn off the printer, and unplug the power cord of the printer from the power supply.

Plug the printer back in and turn the printer back on.

If the problem is not resolved, contact the service center.

6931

Cause

Printer error has occurred.

Action

Turn off the printer, and unplug the power cord of the printer from the power supply.

Plug the printer back in and turn the printer back on.

If the problem is not resolved, contact the service center.

6932

Cause

Printer error has occurred.

Action

Turn off the printer, and unplug the power cord of the printer from the power supply.

Plug the printer back in and turn the printer back on.

If the problem is not resolved, contact the service center.

6933

Cause

Printer error has occurred.

Action

Turn off the printer, and unplug the power cord of the printer from the power supply.

Plug the printer back in and turn the printer back on.

If the problem is not resolved, contact the service center.

6940

Cause

Printer error has occurred.

Action

Turn off the printer, and unplug the power cord of the printer from the power supply.

Plug the printer back in and turn the printer back on.

If the problem is not resolved, contact the service center.

6941

Cause

Printer error has occurred.

Action

Turn off the printer, and unplug the power cord of the printer from the power supply.

Plug the printer back in and turn the printer back on.

If the problem is not resolved, contact the service center.

6942

Cause

Printer error has occurred.

Action

Turn off the printer, and unplug the power cord of the printer from the power supply.

Plug the printer back in and turn the printer back on.

If the problem is not resolved, contact the service center.

6943

Cause

Printer error has occurred.

Action

Turn off the printer, and unplug the power cord of the printer from the power supply.

Plug the printer back in and turn the printer back on.

If the problem is not resolved, contact the service center.

6944

Cause

Printer error has occurred.

Action

Turn off the printer, and unplug the power cord of the printer from the power supply.

Plug the printer back in and turn the printer back on.

If the problem is not resolved, contact the service center.

6945

Cause

Printer error has occurred.

Action

Turn off the printer, and unplug the power cord of the printer from the power supply.

Plug the printer back in and turn the printer back on.

If the problem is not resolved, contact the service center.

6946

Cause

Printer error has occurred.

Action

Turn off the printer, and unplug the power cord of the printer from the power supply.

Plug the printer back in and turn the printer back on.

If the problem is not resolved, contact the service center.

6A00

Cause

Printer error has occurred.

Action

Turn off the printer, and unplug the power cord of the printer from the power supply.

Plug the printer back in and turn the printer back on.

If the problem is not resolved, contact the service center.

6B00

Cause

Printer error has occurred.

Action

Turn off the printer, and unplug the power cord of the printer from the power supply.

Plug the printer back in and turn the printer back on.

If the problem is not resolved, contact the service center.

8200

Cause

Printer error has occurred.

Action

Turn off the printer, and unplug the power cord of the printer from the power supply.

Plug the printer back in and turn the printer back on.

If the problem is not resolved, contact the service center.

9000

Cause

Printer error has occurred.

Action

Turn off the printer, and unplug the power cord of the printer from the power supply.

Plug the printer back in and turn the printer back on.

If the problem is not resolved, contact the service center.

9400

Cause

Printer error has occurred.

Action

Turn off the printer, and unplug the power cord of the printer from the power supply.

Plug the printer back in and turn the printer back on.

If the problem is not resolved, contact the service center.

B200

Cause

An error requiring you to contact the service center has occurred.

Action

Turn off the printer, and unplug the power cord of the printer from the power supply.

Contact the service center.

B400

Cause

Printer error has occurred.

Action

Turn off the printer, and unplug the power cord of the printer from the power supply.

Plug the printer back in and turn the printer back on.

If the problem is not resolved, contact the service center.