



User Guide

© Copyright 2019 HP Development Company, L.P.

HDMI, the HDMI Logo and High-Definition Multimedia Interface are trademarks or registered trademarks of HDMI Licensing LLC. Thunderbolt is a trademark of Intel Corporation in the U.S. and other countries. Windows is either a registered trademark or trademark of Microsoft Corporation in the United States and/or other countries.

The information contained herein is subject to change without notice. The only warranties for HP products and services are set forth in the express warranty statements accompanying such products and services. Nothing herein should be construed as constituting an additional warranty. HP shall not be liable for technical or editorial errors or omissions contained herein.

Product notice

This guide describes features that are common to most models. Some features may not be available on your product. To access the latest user guide, go to <http://www.hp.com/support>, and follow the instructions to find your product. Then select **User Guides**.





Second Edition: May 2019

First Edition: January 2019

Document Part Number: L50855-002

About This Guide

This guide provides information on monitor features, setting up the monitor, and technical specifications.

-
-  **WARNING!** Indicates a hazardous situation that, if not avoided, **could** result in serious injury or death.
 -  **CAUTION:** Indicates a hazardous situation that, if not avoided, **could** result in minor or moderate injury.
 -  **IMPORTANT:** Indicates information considered important but not hazard-related (for example, messages related to property damage). Warns the user that failure to follow a procedure exactly as described could result in loss of data or in damage to hardware or software. Also contains essential information to explain a concept or to complete a task.
 -  **NOTE:** Contains additional information to emphasize or supplement important points of the main text.
 -  **TIP:** Provides helpful hints for completing a task.
-



This product incorporates HDMI technology.

Table of contents

1 Getting started	1
Important safety information	1
Product features and components	2
Features	2
Rear and side components	3
Front controls	4
Setting up the monitor	5
Installing the monitor stand	5
Connecting the cables	6
Connecting USB devices	9
Adjusting the monitor	10
Turning on the monitor	12
HP watermark and image retention policy	12
Installing a security cable	13
Mounting the monitor	13
Removing the monitor stand	13
Attaching the VESA mounting bracket	14
Docking an HP notebook or desktop computer	15
2 Using the monitor	16
Software and utilities	16
The Information file	16
The Image Color Matching file	16
Using the on-screen display (OSD) menu	17
Using the function buttons	18
Reassigning the function buttons	18
Adjusting Low Blue Light Mode	19
DisplayPort multistreaming over USB Type-C	20
Using Auto-Sleep Mode	21
Changing the Power Mode setting	21
3 Support and troubleshooting	22
Solving common problems	22
Button lockouts	22
Contacting support	23
Preparing to call technical support	23

Locating the serial number and product number	23
4 Maintaining the monitor	24
Maintenance guidelines	24
Cleaning the monitor	24
Shipping the monitor	24
Appendix A Technical specifications	25
Preset display resolutions	26
Entering user modes	27
Energy saver feature	27
Appendix B Accessibility	28
Accessibility	28
Finding the technology tools you need	28
Our commitment	28
International Association of Accessibility Professionals (IAAP)	28
Finding the best assistive technology	29
Assessing your needs	29
Accessibility for HP products	29
Standards and legislation	30
Standards	30
Mandate 376 – EN 301 549	30
Web Content Accessibility Guidelines (WCAG)	30
Legislation and regulations	30
United States	31
21st Century Communications and Video Accessibility Act (CVAA)	31
Canada	31
Europe	32
United Kingdom	32
Australia	32
Worldwide	32
Useful accessibility resources and links	33
Organizations	33
Educational institutions	33
Other disability resources	33
HP links	33
Contacting support	34

1 Getting started

Important safety information

An AC power adapter and power cord is included with the monitor. If another cord is used, use only a power source and connection appropriate for this monitor. For information about the correct power cord set to use with the monitor, see the *Product Notices* provided in your documentation kit.

 **WARNING!** To reduce the risk of electric shock or damage to the equipment:

- Plug the power cord into an AC outlet that is easily accessible at all times.
- Disconnect power from the computer by unplugging the power cord from the AC outlet.
- If provided with a 3-pin attachment plug on the power cord, plug the cord into a grounded (earthed) 3-pin outlet. Do not disable the power cord grounding pin, for example, by attaching a 2-pin adapter. The grounding pin is an important safety feature.

For your safety, do not place anything on power cords or cables. Arrange them so that no one may accidentally step on or trip over them. Do not pull on a cord or cable. When unplugging from the AC outlet, grasp the cord by the plug.

To reduce the risk of serious injury, read the *Safety & Comfort Guide*. It describes proper workstation setup, and proper posture, health, and work habits for computer users. The *Safety & Comfort Guide* also provides important electrical and mechanical safety information. The *Safety & Comfort Guide* is available on the Web at <http://www.hp.com/ergo>.

 **IMPORTANT:** For the protection of the monitor, as well as the computer, connect all power cords for the computer and its peripheral devices (such as a monitor, printer, scanner) to some form of surge protection device such as a power strip or uninterruptible power supply (UPS). Not all power strips provide surge protection; the power strips must be specifically labeled as having this capability. Use a power strip whose manufacturer offers a damage replacement policy so you can replace the equipment if surge protection fails.

Use the appropriate and correctly sized furniture designed to properly support your HP LCD monitor.

 **WARNING!** LCD monitors that are inappropriately situated on dressers, bookcases, shelves, desks, speakers, chests, or carts may fall over and cause personal injury.

Care should be taken to route all cords and cables connected to the LCD monitor so that they cannot be pulled, grabbed, or tripped over.

Be sure that the total ampere rating of the products connected to the AC outlet does not exceed the current rating of the outlet, and that the total ampere rating of the products connected to the cord does not exceed the rating of the cord. Look on the power label to determine the ampere rating (AMPS or A) for each device.

Install the monitor near an AC outlet that you can easily reach. Disconnect the monitor by grasping the plug firmly and pulling it from the AC outlet. Never disconnect the monitor by pulling the cord.

Do not drop the monitor or place it on an unstable surface.

 **NOTE:** This product is suitable for entertainment purposes. Consider placing the monitor in a controlled luminous environment to avoid interference from surrounding light and bright surfaces that may cause disturbing reflections from the screen.

Product features and components

Features

The monitor features include the following:

- 55-cm (21.5-in) diagonal viewable screen area with 1920 × 1080 resolution, plus full-screen support for lower resolutions
- Nonglare panel with an LED backlight
- Wide viewing angle to allow viewing from a sitting or standing position, or when moving from side to side
- On-screen display (OSD) adjustments in several languages for easy setup and screen optimization
- Plug and Play capability, if supported by your operating system
- Tilt, swivel, and height adjustment capabilities
- Pivot capability to rotate the monitor head from landscape to portrait orientation
- Removable stand (optional) for flexible monitor head mounting solutions
- USB Type-C and USB Type-A docking for legacy and non-legacy HP notebooks
- One DisplayPort video output for daisy-chaining a second monitor
- High-Definition Multimedia Interface (HDMI)
- Audio-out (headset) jack on side
- USB Type-C upstream port for high-speed data/network, audio and video, and power delivery (up to 65 W)
- Four USB Type-A SuperSpeed downstream ports (two rear ports and two side ports)
- RJ-45 (network) jack
- Security cable slot on rear of monitor for optional security cable
- HP Display Assistant software for adjusting monitor settings and enabling the theft deterrence features
- HDCP (High-bandwidth Digital Content Protection) used on all digital inputs
- Power Saver mode to meet requirements for reduced power consumption



NOTE: For safety and regulatory information, see the *Product Notices* provided in your documentation kit. To access the latest user guides or manuals for your product, go to <http://www.hp.com/support> and follow the instructions to find your product. Then select **User Guides**.

Rear and side components

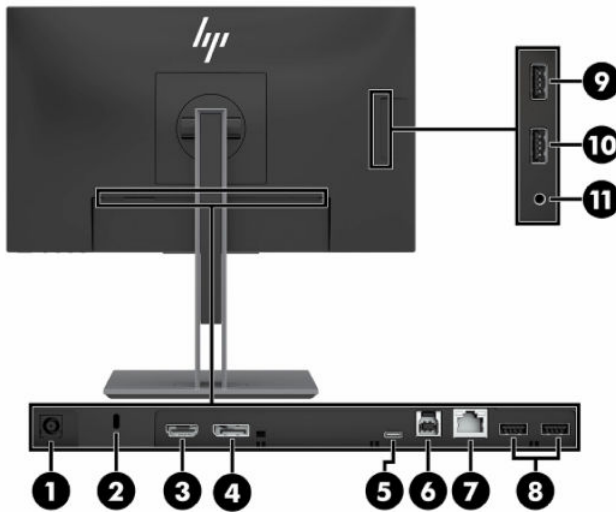

Table 1-1 Rear and side components and their descriptions

Component	Function
(1) DC Power IN connector	Connects an AC adapter.
(2) Security cable slot	Connects an optional security cable.
(3) HDMI port	Connects an HDMI cable to a source device.
(4) DisplayPort OUT port	Connects a DisplayPort cable to a secondary monitor for daisy-chaining.
(5) USB Type-C upstream port	Connects a USB Type-C cable to an HP notebook or desktop computer. Serves as a single connection for video, data, and power delivery (up to 65 W). NOTE: Your computer USB Type-C port must be able to support USB Type-C Alt Mode and data and power delivery. Use only the HP USB Type-C cable provided. Supports DisplayPort Alt Mode (video, charging, and USB 3.1) over the USB Type-C connector. Also compatible with USB Type-C-Thunderbolt™-enabled ports.
(6) USB Type-B upstream port	Connects a USB Type-B cable to a source device.
(7) RJ-45 (network) jack	Connects a network cable.
(8) USB Type-A ports (2)	Connect USB devices.
(9) USB port with HP Sleep and Charge	Connects USB devices. Charges most products such as a cell phone, camera, activity tracker, or smartwatch.
(10) USB Type-A port	Connects a USB device.
(11) Audio-out (headset) jack	Connects optional headphones, earbuds, a headset, or a television audio cable. WARNING! To reduce the risk of personal injury, reduce the volume before using headphones, earbuds, or a headset. For additional safety information, see the <i>Product Notices</i> provided in your documentation kit.

Front controls



Table 1-2 Front controls and their descriptions

Control	Function
(1) Menu button	Press to open the OSD menu, select a menu item from the OSD, or close the OSD menu. An indicator is activated above the Menu button when the OSD menu is open.
(2) Function buttons (assignable)	When the OSD menu is open, press the buttons to navigate through the menu. Lighted icons above the buttons indicate their functions. For a description of these functions, see Using the function buttons on page 18 . You can reassign the function buttons to quickly select the most commonly used operations, see Reassigning the function buttons on page 18 .
(3) Power button	Turns the monitor on or off.

Setting up the monitor

Installing the monitor stand

 **IMPORTANT:** To prevent damage to the monitor, do not touch the surface of the LCD panel. Pressure on the panel may cause nonuniformity of color or disorientation of the liquid crystals. If this occurs, the screen will not recover to its normal condition.

1. Position the monitor facedown on a flat surface covered by a soft clean cloth.
2. Slide the top of the mounting plate on the stand under the upper lip of the recess in the back of the panel (1).
3. Lower the bottom of the stand's mounting plate into the recess until it snaps into place (2).
4. The latch on the bottom of the mounting plate pops up when the stand is locked in place.

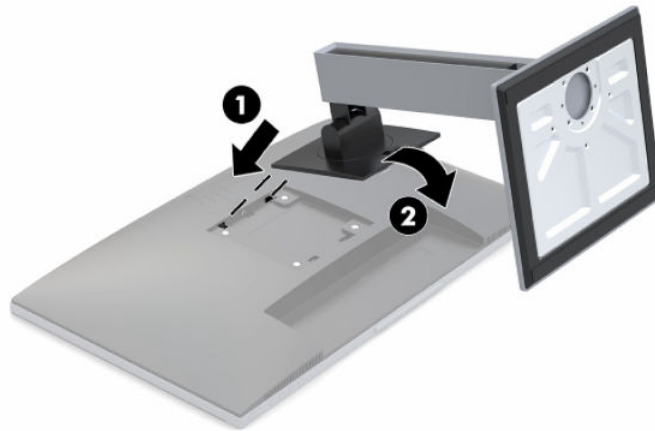

Connecting the cables

 **NOTE:** The monitor ships with select cables. Not all cables shown in this section are included with the monitor.

1. Place the monitor in a convenient, well-ventilated location near the computer.
2. Before connecting the cables, route the cables through the cable routing hole in the center of the stand.

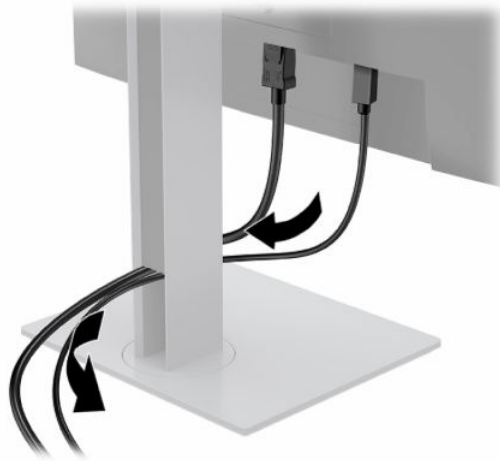

3. Connect a cable or cables to enable video.

 **NOTE:** The monitor automatically determines which inputs have valid video signals. The inputs can be selected by pressing the **Menu** button to access the on-screen display (OSD) menu and then selecting **Input Control**.

- Connect one end of a USB Type-B cable to the USB Type-B upstream port on the rear of the monitor and the other end to the USB Type-A port on the source device. This enables video and data pass-through.

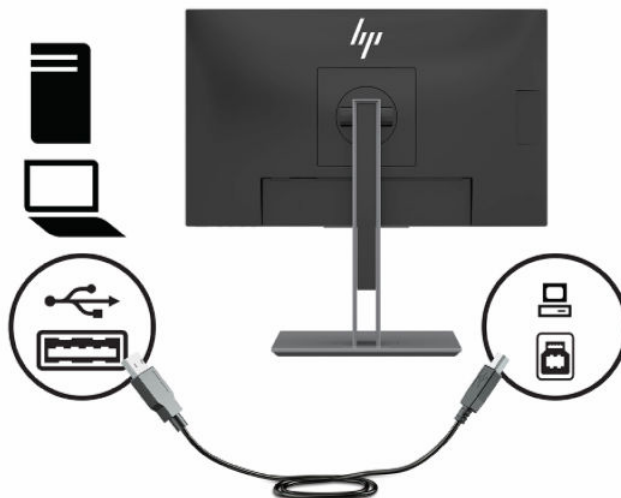

- Connect one end of an HDMI cable to the HDMI port on the rear of the monitor and the other end to the HDMI port on the source device.

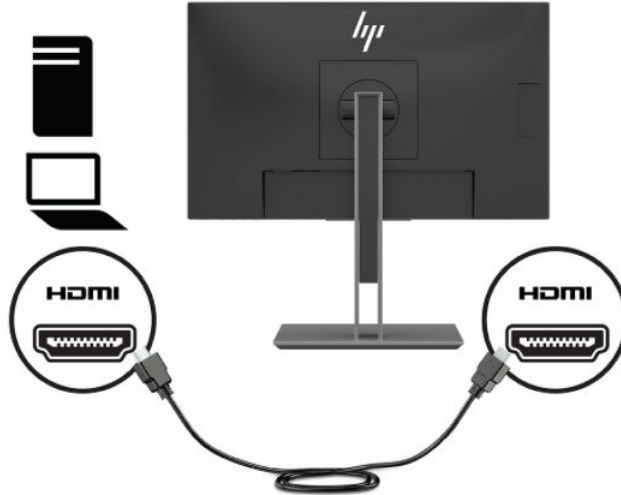

- Connect one end of a USB Type-C cable to the USB Type-C port on the rear of the monitor and the other end to the USB Type-C port on the source device. (Use only the HP-approved USB Type-C cable provided with the monitor.)

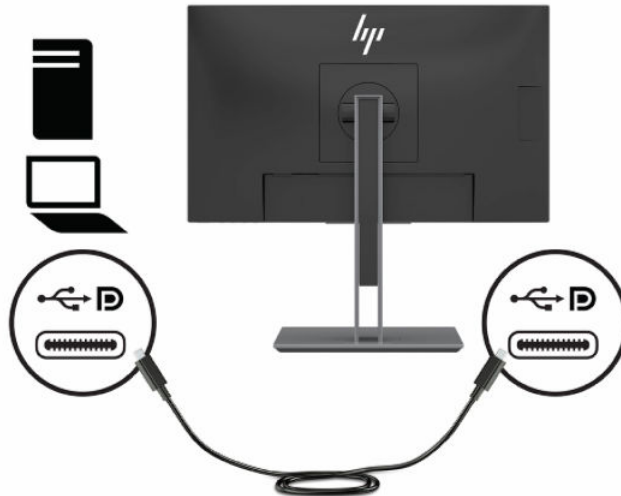

 **NOTE:** The monitor's USB Type-C port provides network, data, video, and power delivery (up to 65 W).

The host device must be able to support DisplayPort Alt Mode (video, charging and USB 3.1) over the USB Type-C connector. The host device must also be compatible with USB Type-C-Thunderbolt-enabled ports.

4. Connect one end of a network cable to the network jack on the monitor and the other end to a network wall jack or router.

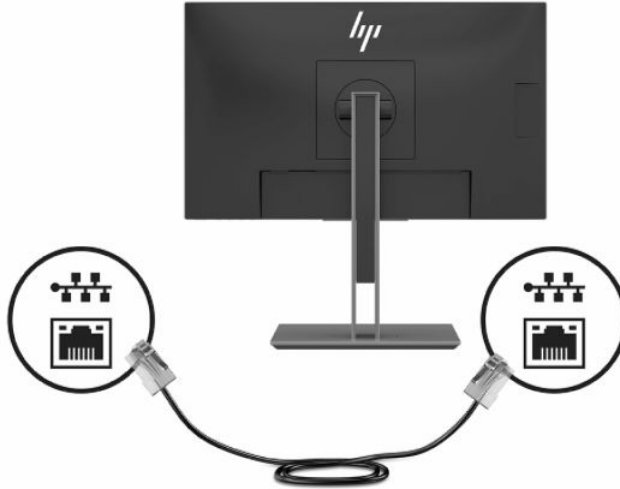

5. Connect one end of the power cord to the AC adapter (1) and the other end to a grounded AC outlet (2), and then connect the AC adapter to the power IN connector on the monitor (3).

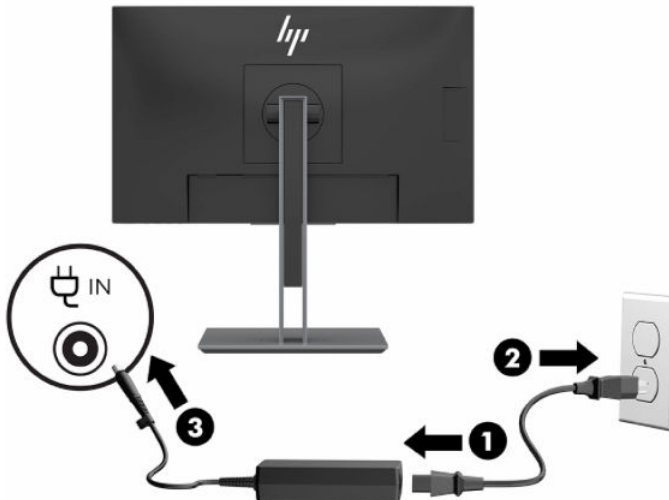

⚠ WARNING! To reduce the risk of electric shock or damage to the equipment:

Do not disable the power cord grounding plug. The grounding plug is an important safety feature.

Plug the power cord into a grounded (earthed) AC outlet that is easily accessible at all times.

Disconnect power from the equipment by unplugging the power cord from the AC outlet.

For your safety, do not place anything on power cords or cables. Arrange them so that no one may accidentally step on or trip over them. Do not pull on a cord or cable. When unplugging the power cord from the AC outlet, grasp the cord by the plug.

Connecting USB devices

The rear of the monitor provides one USB Type-B and one USB Type-C port that function as an upstream hub for the monitor's USB Type-A downstream ports. There are two USB Type-A downstream ports on the rear of the monitor and two USB Type-A downstream ports on the side of the monitor.

 **NOTE:** You must connect the USB Type-C upstream cable or USB Type-B upstream cable from the source device to the rear of the monitor to enable the USB Type-A downstream ports on the monitor.

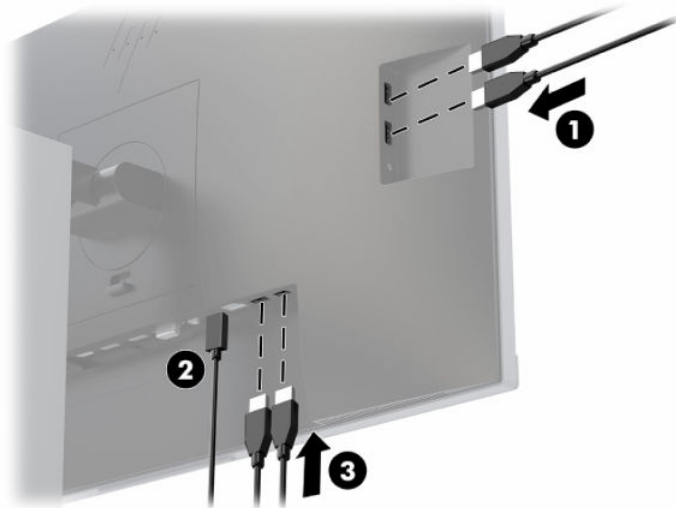
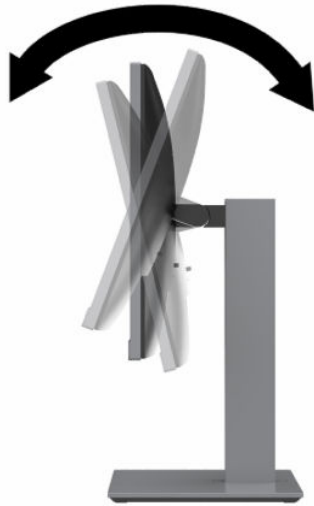

Table 1-3 USB port locations

Components	Ports
1	USB Type-A downstream ports
2	USB Type-C or USB Type-B upstream port from PC
3	USB Type-A downstream ports

Adjusting the monitor

1. Tilt the monitor head forward or backward to set it to a comfortable eye level.



2. Swivel the monitor head to the left or right for the best viewing angle.

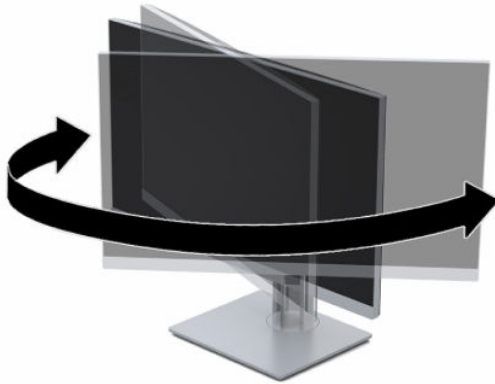

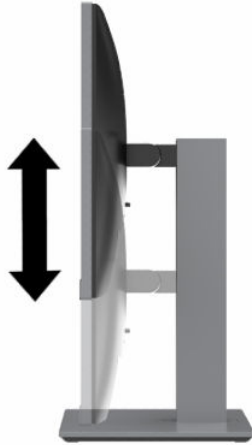

3. Adjust the monitor's height to a comfortable position for your individual workstation. The monitor's top bezel edge should be no higher than eye level. A monitor that is positioned low and reclined may be more comfortable for users with corrective lenses. The monitor should be repositioned as you adjust your working posture throughout the work day.

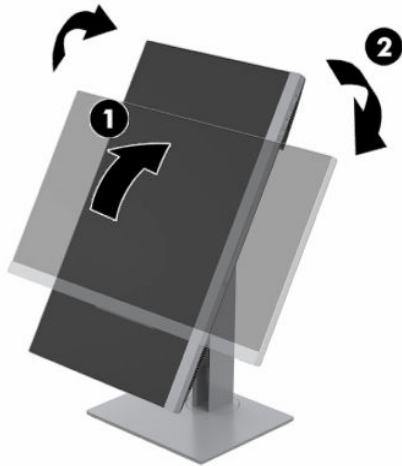

4. You can pivot the monitor head from landscape to portrait orientation viewing to adapt to your application.
 - a. Adjust the monitor to full height position and tilt the monitor head back to full tilt position (1).
 - b. Pivot the monitor head clockwise or counter-clockwise 90° from landscape to portrait orientation (2).

 **IMPORTANT:** If the monitor is not in full-height and full-tilt position when pivoting, the bottom corner of the monitor head will come in contact with the base and potentially cause damage to the monitor.



 **NOTE:** To view information about the screen in portrait mode, you can use the HP Display Assistant software by downloading it and installing on your computer from <http://www.hp.com/support>. The position of the OSD menu can also be rotated to portrait orientation. To rotate the OSD menu, press the **Menu** button to open the OSD, select **Menu Control** from the menu, and then select **Menu Rotation**.

Turning on the monitor

1. Press the power button on the computer to turn it on.
2. Press the power button on the bottom of the monitor to turn it on.



IMPORTANT: Burn-in image damage may occur on monitors that display the same static image on the screen for 12 or more consecutive hours of nonuse. To avoid burn-in image damage on the monitor screen, you should always activate a screen saver application or turn off the monitor when it is not in use for a prolonged period of time. Image retention is a condition that may occur on all LCD screens. A burned-in image on the monitor is not covered under the HP warranty.

NOTE: If pressing the power button has no effect, the Power Button Lockout feature may be enabled. To disable this feature, press and hold the monitor power button for 10 seconds.

NOTE: You can disable the power light in the OSD menu. Press the **Menu** button to open the OSD, and then select **Power Control**. Select **Power LED**, and then select **Off**.

When the monitor is first turned on, a Monitor Status message is displayed for five seconds. The message shows which input is the current active signal, the status of the auto-switch source setting (On or Off; default setting is On), the current preset screen resolution, and the recommended preset screen resolution.

The monitor automatically scans the signal inputs for an active input and uses that input for the screen.

HP watermark and image retention policy

The IPS monitor models are designed with IPS (In-Plane Switching) display technology which provides ultra-wide viewing angles and advanced image quality. IPS monitors are suitable for a wide variety of advanced image quality applications. This panel technology, however, is not suitable for applications that exhibit static, stationary, or fixed images for long periods of time without the use of screen savers. These types of applications may include camera surveillance, video games, marketing logos, and templates that are displayed on the screen for a prolonged period of time. Static images may cause image retention damage that could look like stains or watermarks on the monitor's screen.

A burned-in image on the monitor is not covered under the HP warranty. To avoid image retention damage, either turn off the monitor when it is not in use or use the power management setting, if supported on your system, to turn off the monitor when the system is idle.

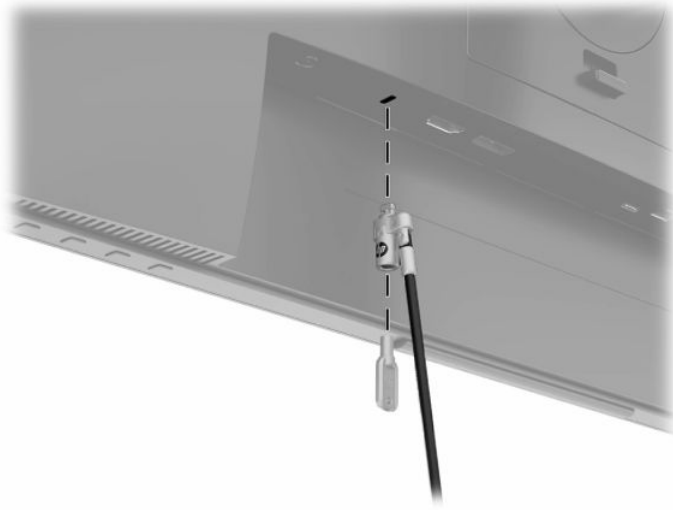

Installing a security cable

You can secure the monitor to a fixed object with an optional security cable available from HP.



Mounting the monitor

The monitor head can be attached to a wall, swing arm, or other mounting fixture.

-
-  **NOTE:** This apparatus is intended to be supported by a UL- or CSA-Listed wall-mount bracket.
 -  **IMPORTANT:** This monitor supports the VESA industry-standard 100 mm mounting holes. To attach a third-party mounting solution to the monitor head, use four 4 mm, 0.7 pitch, 10 mm-long screws. Longer screws must not be used because they may damage the monitor. It is important to verify that the manufacturer's mounting solution is compliant with the VESA standard and is rated to support the weight of the monitor head. For best performance, it is important to use the power and video cables provided with the monitor.
-

Removing the monitor stand

-
-  **IMPORTANT:** Before beginning to disassemble the monitor, be sure that the monitor is turned off and all cables are disconnected.
-

1. Disconnect and remove all cables from the monitor.
2. Position the monitor facedown on a flat surface covered by a soft clean cloth.
3. Push up on the latch near the bottom center of the stand's mounting plate (1).
4. Swing the bottom of the stand up until the mounting plate clears the recess in the monitor head (2).

5. Slide the stand out of the recess.

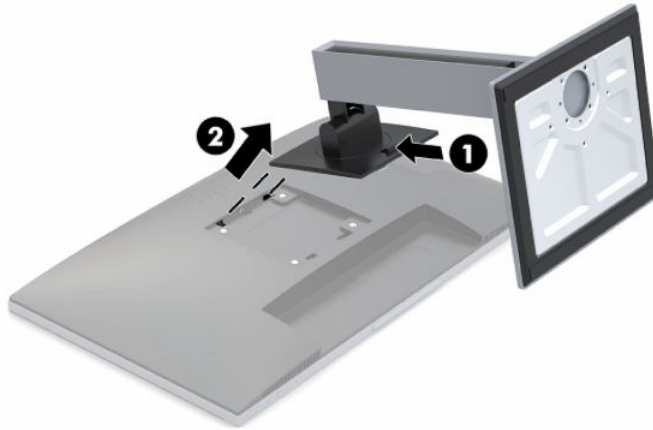

Attaching the VESA mounting bracket

1. Remove the four screws from the VESA holes located on the rear of the monitor head.

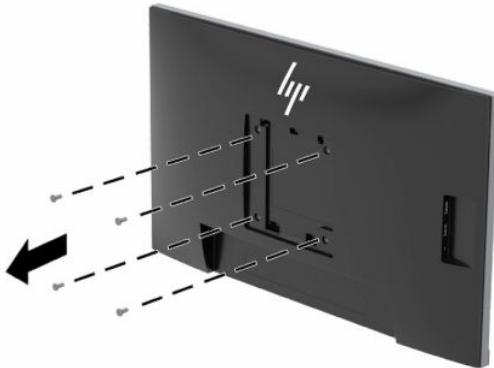

2. To attach the monitor head to a swing arm or other mounting device, insert four mounting screws through the holes on the mounting device and into the VESA screw holes on the monitor head.

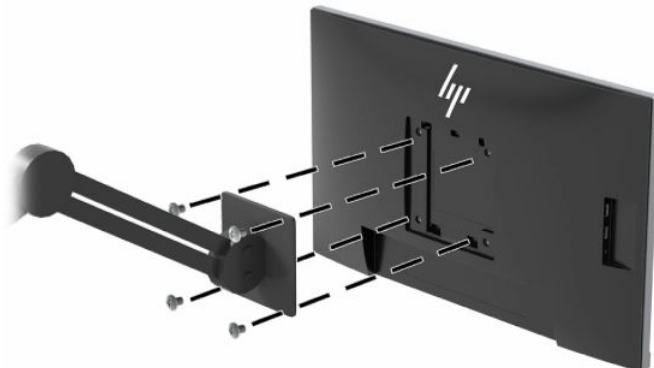

Docking an HP notebook or desktop computer

You can dock an HP notebook or desktop computer to the monitor with a single USB Type-C connection. The USB Type-C port provides network, data, video, and power delivery when docking an HP notebook. Make sure the network cable is connected from the network source jack to the monitor's network jack for a network connection through USB Type-C.

NOTE: The host PC must be able to support DisplayPort Alt Mode (video, charging, and USB 3.1) over the USB Type-C connector and also be compatible with USB Type-C-Thunderbolt-enabled ports.

Connecting two host PCs to the docking monitor may result in system shutdown, loss of power, and the need to turn off and restart the monitor.

To dock an HP notebook or desktop computer, connect one end of a USB Type-C cable to the USB Type-C port on the rear of the monitor and the other end to the USB Type-C port on the HP notebook or desktop computer. This USB Type-C cable provides single-cable connectivity for high-speed data, audio and video, and power delivery.

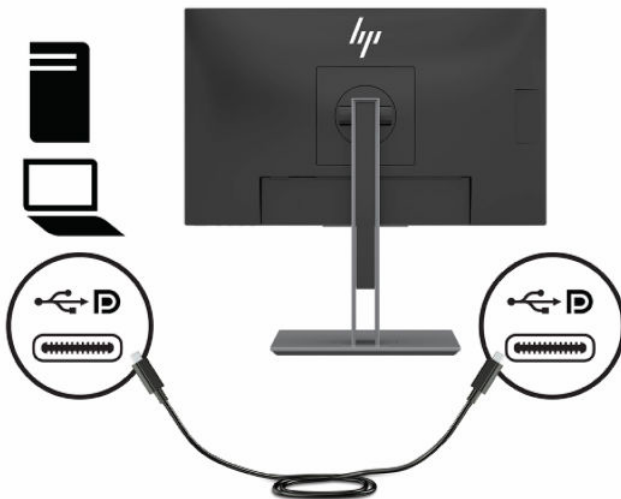

If your HP notebook or desktop computer does not have a USB Type-C port, you can use a USB Type-A-to-USB Type-B cable for docking. Connect the USB Type-B end of the cable to the monitor and the USB Type-A end to the HP notebook or desktop computer.

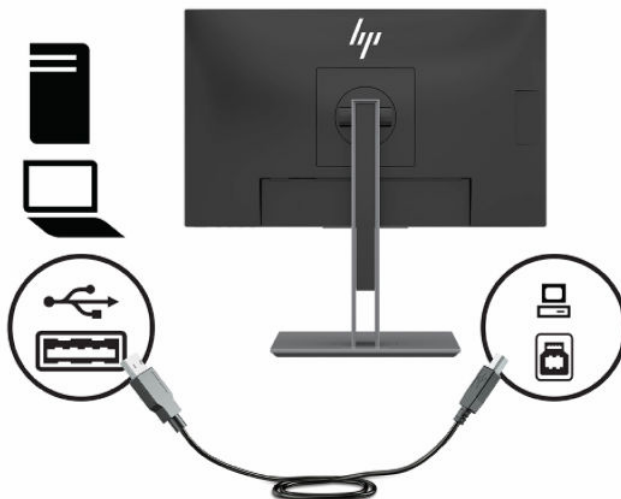

NOTE: The monitor delivers up to 65 W of power over USB Type-C port for video, data, network, and power.

2 Using the monitor

Software and utilities

You can download and install the following files from <http://www.hp.com/support>.

- INF (Information) file
- ICM (Image Color Matching) files
- HP Display Assistant — adjusts the monitor settings and enables theft deterrence features

To download the files:

1. Go to <http://www.hp.com/support>.
2. Select **Software and Drivers**.
3. Select your product type.
4. Enter your HP monitor model in the search field.

The Information file

The INF file defines monitor resources used by Windows® operating systems to ensure monitor compatibility with the computer's graphics adapter.

This monitor is Windows Plug and Play-compatible and the monitor will work correctly without installing the INF file. Monitor Plug and Play-compatibility requires that the computer's graphic card is VESA DDC2-compliant and that the monitor connects directly to the graphics card. Plug and Play does not work through separate BNC-type connectors or through distribution buffers/boxes.

The Image Color Matching file

The ICM files are data files that are used in conjunction with graphics programs to provide consistent color matching from monitor screen to printer, or from scanner to monitor screen. This file is activated from within graphics programs that support this feature.



NOTE: The ICM color profile is written in accordance with the International Color Consortium (ICC) Profile Format specification.

Using the on-screen display (OSD) menu

Use the on-screen display (OSD) menu to adjust the screen image based on your viewing preferences. You can access and make adjustments in the OSD using the buttons at the bottom of the monitor's front bezel.

To access the OSD menu and make adjustments, do the following:

1. If the monitor is not already on, press the power button to turn on the monitor.
2. To access the OSD menu, press the **Menu** button to open the OSD.
3. Use the three function buttons to navigate, select, and adjust the menu choices. The on-screen button labels vary depending on which menu or submenu is active.

The following table lists the menu selections in the OSD main menu.

Table 2-1 OSD menu options and descriptions

Main menu	Description
Brightness	Adjusts the brightness level of the screen. The factory default is 90.
Contrast	Adjusts the contrast level of the screen. The factory default is 80.
Color Control	Selects and adjusts the screen color.
Input Control	Selects the video input signal.
Image Control	Adjusts the screen image.
Power Control	Adjusts the power settings.
Menu Control	Adjusts the on-screen display (OSD) and function button controls.
Management	Adjusts the DDC/CI settings, selects the language in which the OSD menu is displayed (the factory default is English), and returns all OSD menu settings to the factory default settings.
USB Host Selection	Selects the USB host.
Information	Selects and displays important information about the monitor.
Exit	Exits the OSD menu screen.

Using the function buttons

Pressing one of the function buttons activates the buttons and displays icons above the buttons.

NOTE: The actions of the function buttons varies among monitor models.

The default button icons and functions are shown below. For information about changing the function of the buttons, see [Reassigning the function buttons on page 18](#).

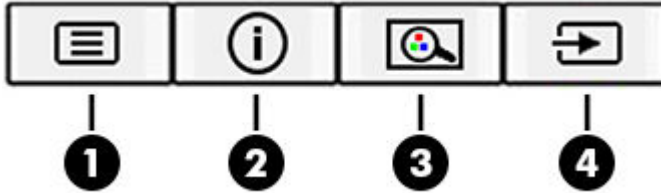

Table 2-2 Button names and descriptions

Button	Function
(1) Menu button	Opens the OSD main menu, selects a menu item from the OSD, or closes the OSD menu.
(2) Information button Assignable function button	For digital input, opens the Information menu.
(3) Viewing Modes button Assignable function button	Opens the Viewing Modes menu where you can adjust the monitor screen to a comfortable viewing light or select a preset view mode.
(4) Next Active Input button Assignable function button	Switches the monitor's input source to the next active input.

Reassigning the function buttons

You can change the assignable function buttons from their default values so that when the buttons are activated you can quickly access commonly used menu items. You cannot reassign the [Menu](#) button.

To reassign the function buttons:

1. Press the [Menu](#) button to open the OSD menu.
2. Select **Menu Control**, select **Assign Buttons**, and then select one of the available options for the button you want to assign.

NOTE: To view an OSD menu simulator, visit the HP Customer Self Repair Services Media Library at <http://www.hp.com/go/sml>.

Adjusting Low Blue Light Mode

Decreasing the blue light emitted by the monitor reduces the blue light exposure to your eyes. This monitor allows you to select a setting to reduce blue light output and create a more relaxing and less stimulating image while you read content on the screen.

To adjust the blue light output from the monitor:

1. Press one of the four OSD bezel buttons on the bottom of the monitor to display the OSD icons on the screen.
2. Press the **Viewing Modes** button to open the Viewing Modes menu, or press the **Menu** button, select **Color Control**, and then select **Viewing Modes**.
3. Select your desired setting:
 - **Low Blue Light:** (TUV certified) Reduces blue light for improved eye comfort.
 - **Reading:** Optimizes blue light and brightness for indoor viewing.
 - **Night:** Adjusts to the lowest blue light and reduces the impact on sleep.
4. Select **Save and Return** to save your setting and close the menu. Select **Cancel** if you don't want to save the setting.
5. Select **Exit** from the Main menu.

 **WARNING!** To reduce the risk of serious injury, read the *Safety & Comfort Guide*. It describes proper workstation setup and proper posture, health, and work habits for computer users. The *Safety & Comfort Guide* also provides important electrical and mechanical safety information. The *Safety & Comfort Guide* is available on the Web at <http://www.hp.com/ergo>.

DisplayPort multistreaming over USB Type-C

If you are using USB Type-C as the primary video input source, you can multistream to other DisplayPort monitors connected in a daisy chain configuration. You can connect up to four monitors in this configuration if the graphics card in your computer supports this configuration.

The number of monitors you can connect through DisplayPort multistreaming depends on a number of factors, including the resolutions and scan rates used for each monitor and the capabilities of your GPU or embedded graphics system. Check the manual that came with your graphics card for further information about its capabilities.

To multistream:

1. Make sure that USB Type-C is used for your primary video input.
2. Add a second monitor by connecting a DisplayPort cable between the DisplayPort OUT port on the primary monitor and the DisplayPort IN port on a secondary monitor.

 **NOTE:** The secondary monitor should not be the same model as the primary monitor.

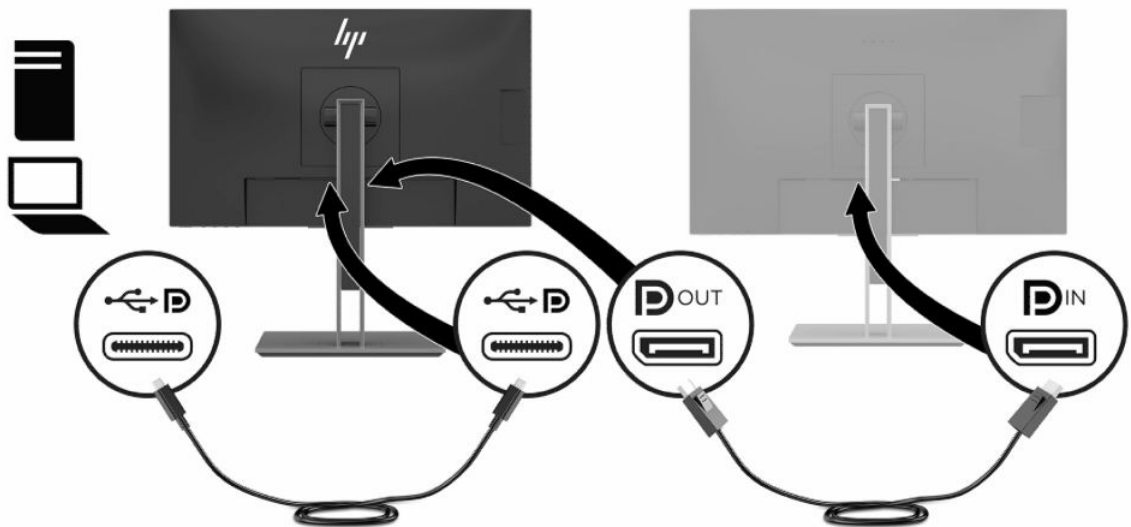

3. Set a connected monitor to display the same image as the primary monitor or a different image.
DisplayPort 1.1 is the default setting, but the setting automatically changes to DisplayPort 1.2 when DisplayPort OUT is connected to the secondary monitor.
4. To connect additional monitors downstream (up to four maximum), press the **Menu** button to open the OSD menu. Navigate to the USB Type-C configuration and select **USB-C Video+USB2.0**.

 **NOTE:** All but the final monitor in the chain must support DisplayPort multistreaming.

5. Connect the DisplayPort cable from the DisplayPort OUT port of one monitor to the DisplayPort IN port of the next monitor.
6. If you want different information on each screen, be sure that all upstream monitors are configured to DisplayPort 1.2 mode, as described above.

Using Auto-Sleep Mode

The monitor supports an on-screen display (OSD) menu option called Auto-Sleep Mode that allows you to enable or disable a reduced power state for the monitor. When Auto-Sleep Mode is enabled, the monitor enters a reduced power state when the host computer signals low power mode, absence of either horizontal or vertical sync signal. Auto-Sleep Mode is enabled by default.

Upon entering this reduced power state (sleep mode), the monitor screen is blanked, the backlight is turned off, and the power light indicator turns amber. The monitor draws less than 0.5 W of power when in this reduced power state. The monitor wakes from the sleep mode when the host device sends an active signal to the monitor (for example, if you activate the mouse or keyboard).

To disable Auto-Sleep Mode:

1. Press the **Menu** button to open the OSD.
2. In the OSD menu, select **Power Control**, select **Auto-Sleep Mode**, and then select **Off**.

Changing the Power Mode setting

When in sleep mode, to comply with international power standards, the monitor default setting is Power Saver mode. If your display supports Performance mode, then to keep the USB ports enabled even when the monitor is in Auto-Sleep Mode, change the Power Mode setting from Power Saver to Performance.

To change the Power Mode setting:

1. Press the **Menu** button to open the OSD menu.
2. Select **Power Control**, select **Power Mode**, and then select **Performance**.
3. Select **Save** and close the OSD.

3 Support and troubleshooting

Solving common problems

The following table lists possible problems, the possible cause of each problem, and the recommended solutions.

Table 3-1 Common problems and solutions

Problem	Possible cause	Solution
Screen is blank or video is flashing.	Power cord is disconnected.	Connect the monitor power cord.
	Monitor is turned off.	Press the monitor power button. NOTE: If pressing the power button has no effect, press and hold the power button for 10 seconds to disable the Power Button Lockout feature.
	Video cable is not connected.	Connect a video cable between the source device and monitor. Be sure the computer power is off when connecting the video cable. See Connecting the cables on page 6 for more information.
	System is in sleep mode.	Press any key on the keyboard or move the mouse to exit sleep mode.
	Video card is incompatible.	Replace the video card or connect the video cable to one of the computer's onboard video sources.
Image appears too dark.	Brightness setting is too low.	Open the OSD menu and select Brightness to adjust the brightness scale as needed.
"Input Signal Not Found" is displayed on the screen.	Monitor video cable is disconnected.	Connect the appropriate video signal cable between the computer and monitor. Be sure that the computer power is off when connecting the video cable.
"Input Signal Out of Range" is displayed on the screen.	Video resolution and/or refresh rate are set higher than the monitor supports.	Change the settings to a supported setting. See Preset display resolutions on page 26 for more information.
The monitor is off but it did not seem to enter a low-power sleep mode.	The monitor's sleep mode is disabled.	Open the OSD menu and select Power Control , select Auto-Sleep Mode , and then set auto-sleep to On .
"OSD Lockout" is displayed on the screen.	The monitor's OSD Lockout function is enabled.	Press and hold the Menu button for 10 seconds to disable the OSD Lockout function.
"Power Button Lockout" is displayed on the screen.	The monitor's Power Button Lockout function is enabled.	Press and hold the power button for 10 seconds to disable the Power Button Lockout function.

Button lockouts

Holding down the power button or **Menu** button for ten seconds will lock out the functionality of that button. You can restore the functionality by holding the button down again for ten seconds. This functionality is only available when the monitor is on, displaying an active signal, and the OSD is not active.

Contacting support

To resolve a hardware or software problem, go to <http://www.hp.com/support>. Use this site to get more information about your product, including links to discussion forums and instructions about troubleshooting. You can also find information on how to contact HP and open a support case.

Preparing to call technical support

If you cannot solve a problem using the troubleshooting tips in this section, you may need to call technical support. Have the following information available when you call:

- Monitor model number
- Monitor serial number
- Purchase date on invoice
- Conditions under which the problem occurred
- Error messages received
- Hardware configuration
- Name and version of the hardware and software you are using

Locating the serial number and product number

The serial number and product number are located on a label on the rear of the monitor head. You may need these numbers when contacting HP about the monitor model.

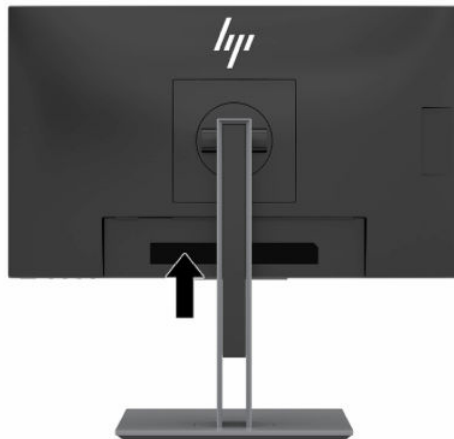

4 Maintaining the monitor

Maintenance guidelines

To enhance the performance and extend the life of the monitor:

- Do not open the monitor cabinet or attempt to service this product yourself. Adjust only those controls that are covered in the operating instructions. If the monitor is not operating properly or has been dropped or damaged, contact an authorized HP dealer, reseller, or service provider.
- Use only a power source and connection appropriate for this monitor, as indicated on the label/back plate of the monitor.
- Be sure the total ampere rating of the products connected to the AC outlet does not exceed the current rating of the AC outlet, and the total ampere rating of the products connected to the cord does not exceed the rating of the cord. Look on the power label to determine the ampere rating (AMPS or A) for each device.
- Install the monitor near an outlet that you can easily reach. Disconnect the monitor by grasping the plug firmly and pulling it from the outlet. Never disconnect the monitor by pulling the cord.
- Turn the monitor off when not in use. You can substantially increase the life expectancy of the monitor by using a screen saver program and turning off the monitor when not in use.



NOTE: A burned-in image on the monitor is not covered under the HP warranty.

- Slots and openings in the cabinet are provided for ventilation. These openings must not be blocked or covered. Never push objects of any kind into cabinet slots or other openings.
- Do not drop the monitor or place it on an unstable surface.
- Do not allow anything to rest on the power cord. Do not walk on the cord.
- Keep the monitor in a well-ventilated area, away from excessive light, heat, or moisture.
- When removing the monitor stand, you must position the monitor facedown on a soft area to prevent it from getting scratched, defaced, or broken.

Cleaning the monitor

1. Turn off the monitor and unplug the power cord from the AC outlet.
2. Dust the monitor by wiping the screen and the cabinet with a soft, clean antistatic cloth.
3. For more difficult cleaning situations, use a 50/50 mix of water and Isopropyl alcohol.



IMPORTANT: Spray the cleaner onto a cloth and use the damp cloth to gently wipe the screen surface. Never spray the cleaner directly on the screen surface. It may run behind the bezel and damage the electronics.

IMPORTANT: Do not use cleaners that contain any petroleum-based materials such as benzene, thinner, or any volatile substance to clean the monitor screen or cabinet. These chemicals may damage the monitor.

Shipping the monitor

Keep the original packing box in a storage area. You may need it later if you move or ship the monitor.

A Technical specifications



NOTE: All specifications represent the typical specifications provided by HP's component manufacturers; actual performance may vary either higher or lower.

For the latest specifications or additional specifications on this product, go to <http://www.hp.com/go/quickspecs/> and search for your specific monitor model to find the model-specific QuickSpecs.

Table A-1 Specifications

Specification	Measurement	
Display	55-cm wide screen	21.5-in wide screen
Type	IPS LCD	
Viewable image size	55 cm diagonal	21.5 in diagonal
Maximum weight (unpacked)	5.08 kg	11.2 lb
Dimensions (including base)		
Height (highest position)	44.86 cm	17.66 in
Height (lowest position)	29.86 cm	11.76 in
Depth	20.50 cm	8.07 in
Width	48.83 cm	19.55 in
Height adjustment range	150 mm	5.9 in
Tilt adjustment range	-5° to 23°	
Swivel adjustment range	45°	
Maximum graphic resolution	1920 × 1080	
Optimum graphic resolution	1920 × 1080	
Environmental requirements		
Operating temperature	5° C to 35° C	41° F to 95° F
Storage temperature	-20° C to 60° C	-4° F to 140° F
Storage humidity	5% to 95% (non-condensing)	
Operating humidity	20% to 80% (non-condensing)	
Altitude:		
Operating	0 m to 5,000 m	0 ft to 16,400 ft
Storage	0 m to 12,192 m	0 ft to 40,000 ft
Power source	100–240 VAC 50/60 Hz	
Power adapter	Manufacturer: Delta, Chicony	
	Model number: TPC-DA52, TPC-CA52	
	Output rating: 19.5 V / 7.7 A	
Measured power consumption		

Table A-1 Specifications (continued)

Specification	Measurement
Full power	140 W (without DC power out, with power delivery)
Typical settings	38 W
Sleep	0.5 W
Off	0.5 W
USB Type-C power supply output	5 V DC, 3.0 A
	9 V DC, 3.0 A
	10 V DC, 5.0 A
	12 V DC, 5.0 A
	15 V DC, 4.3 A
	20 V DC, 3.25 A
Input terminal	One USB Type-C port, one HDMI port

Preset display resolutions

The display resolutions listed below are the most commonly used modes and are set as factory defaults. The monitor automatically recognizes these preset modes and they will appear properly sized and centered on the screen.

Table A-2 Preset display resolutions

Preset	Pixel format	Horz freq (kHz)	Vert freq (Hz)
(1)	640 × 480	31.469	59.940
(2)	720 × 400	31.469	70.087
(3)	800 × 600	37.879	60.317
(4)	1024 × 768	48.363	60.004
(5)	1280 × 720	45.000	60.000
(6)	1280 × 800	49.702	59.810
(7)	1280 × 1024	63.981	60.020
(8)	1440 × 900	55.935	59.887
(9)	1600 × 900	60.000	60.000
(10)	1680 × 1050	65.290	59.954
(11)	1920 × 1080	67.500	60.000

Table A-3 Preset timing resolutions

Preset	Timing name	Pixel format	Horz freq (kHz)	Vert freq (Hz)
(1)	480p	640 × 480	31.469	59.940

Table A-3 Preset timing resolutions (continued)

Preset	Timing name	Pixel format	Horz freq (kHz)	Vert freq (Hz)
(2)	480p	720 × 480	31.469	59.940
(3)	480i	720 × 480	15.734	59.940
(4)	576p	720 × 576	31.250	50.000
(5)	576i	720 × 576	15.625	50.000
(6)	720p50	1280 × 720	37.500	50.000
(7)	720p60	1280 × 720	45.000	60.000
(8)	1080p60	1920 × 1080	67.500	60.000
(9)	1080p50	1920 × 1080	56.250	50.000
(10)	1080i50	1920 × 1080	28.125	50.000
(11)	1080i60	1920 × 1080	33.750	60.000

Entering user modes

Under the following conditions, the video controller signal may occasionally call for a mode that is not preset:

- You are not using a standard graphics adapter.
- You are not using a preset mode.

If this occurs, you may need to readjust the parameters of the monitor screen by using the on-screen display menu. Your changes can be made to any or all of these modes and saved in memory. The monitor automatically stores the new setting and then recognizes the new mode just as it does a preset mode. In addition to the factory preset modes, there are at least 10 user modes that can be entered and stored.

Energy saver feature

The monitor supports a reduced power state. The reduced power state will be initiated if the monitor detects the absence of either the horizontal sync signal or the vertical sync signal. Upon detecting the absence of these signals, the monitor screen is blanked, the backlight is turned off, and the power light turns amber. When the monitor is in the reduced power state, the monitor will utilize 0.5 watts of power. There is a brief warm-up period before the monitor will return to its normal operating mode.

See the computer manual for instructions on setting energy saver features (sometimes called power management features).



NOTE: The energy saver feature only works when the monitor is connected to a computer that has energy saver features.

By selecting the settings in the monitor's Energy Saver utility, you can also program the monitor to initiate the reduced power state at a predetermined time. When the monitor's Energy Saver utility causes the monitor to initiate the reduced power state, the power light blinks amber.

B Accessibility

Accessibility

HP is working to weave diversity, inclusion and work/life into the fabric of our company, so it is reflected in everything we do. Here are some examples of how we are putting differences to work to create an inclusive environment focused on connecting people to the power of technology throughout the world.

Finding the technology tools you need

Technology can unleash your human potential. Assistive technology removes barriers and helps you create independence at home, at work, and in the community. Assistive technology helps increase, maintain, and improve the functional capabilities of electronic and information technology. For more information, see [Finding the best assistive technology on page 29](#).

Our commitment

HP is committed to providing products and services that are accessible for people with disabilities. This commitment supports our company's diversity objectives and helps us ensure that the benefits of technology are available to all.

Our accessibility goal is to design, produce, and market products and services that can be effectively used by everyone, including people with disabilities, either on a stand-alone basis or with appropriate assistive devices.

To achieve our goal, this Accessibility Policy establishes seven key objectives to guide our actions as a company. All HP managers and employees are expected to support these objectives and their implementation in accordance with their roles and responsibilities:

- Raise the level of awareness of accessibility issues within our company, and provide our employees with the training they need to design, produce, market, and deliver accessible products and services.
- Develop accessibility guidelines for products and services, and hold product development groups accountable for implementing these guidelines where competitively, technically, and economically feasible.
- Involve people with disabilities in the development of accessibility guidelines, and in the design and testing of products and services.
- Document accessibility features and make information about our products and services publicly available in an accessible form.
- Establish relationships with leading assistive technology and solution providers.
- Support internal and external research and development that will improve assistive technology relevant to our products and services.
- Support and contribute to industry standards and guidelines for accessibility.

International Association of Accessibility Professionals (IAAP)

IAAP is a not-for-profit association focused on advancing the accessibility profession through networking, education, and certification. The objective is to help accessibility professionals develop and advance their careers and to better enable organizations to integrate accessibility into their products and infrastructure.

HP is a founding member, and we joined to participate with other organizations to advance the field of accessibility. This commitment supports our company's accessibility goal of designing, producing, and marketing products and services that can be effectively used by people with disabilities.

IAAP will make our profession strong by globally connecting individuals, students, and organizations to learn from one another. If you are interested in learning more, go to <http://www.accessibilityassociation.org> to join the online community, sign up for newsletters, and learn about membership options.

Finding the best assistive technology

Everyone, including people with disabilities or age-related limitations, should be able to communicate, express themselves, and connect with the world using technology. HP is committed to increasing accessibility awareness within HP and with our customers and partners. Whether it's large fonts that are easy on the eyes, voice recognition that lets you give your hands a rest, or any other assistive technology to help with your specific situation—a variety of assistive technologies make HP products easier to use. How do you choose?

Assessing your needs

Technology can unleash your potential. Assistive technology removes barriers and helps you create independence at home, at work, and in the community. Assistive technology (AT) helps increase, maintain, and improve the functional capabilities of electronic and information technology.

You may choose from many AT products. Your AT assessment should allow you to evaluate several products, answer your questions, and facilitate your selection of the best solution for your situation. You will find that professionals qualified to do AT assessments come from many fields, including those licensed or certified in physical therapy, occupational therapy, speech/language pathology, and other areas of expertise. Others, while not certified or licensed, may also provide evaluation information. You will want to ask about the individual's experience, expertise, and fees to determine if they are appropriate for your needs.

Accessibility for HP products

The following links provide information on accessibility features and assistive technology, if applicable, included in various HP products. These resources will help you select the specific assistive technology features and product(s) most appropriate for your situation.

- [HP Elite x3—Accessibility Options \(Windows 10 Mobile\)](#)
- [HP PCs—Windows 7 Accessibility Options](#)
- [HP PCs—Windows 8 Accessibility Options](#)
- [HP PC's—Windows 10 Accessibility Options](#)
- [HP Slate 7 Tablets—Enabling Accessibility Features on Your HP Tablet \(Android 4.1/Jelly Bean\)](#)
- [HP SlateBook PCs—Enabling Accessibility Features \(Android 4.3, 4.2/Jelly Bean\)](#)
- [HP Chromebook PCs—Enabling Accessibility Features on Your HP Chromebook or Chromebox \(Chrome OS\)](#)
- [HP Shopping—peripherals for HP products](#)

If you need additional support with the accessibility features on your HP product, see [Contacting support on page 34](#).

Additional links to external partners and suppliers that may provide additional assistance:

- [Microsoft Accessibility information \(Windows 7, Windows 8, Windows 10, Microsoft Office\)](#)
- [Google Products accessibility information \(Android, Chrome, Google Apps\)](#)

- [Assistive Technologies sorted by impairment type](#)
- [Assistive Technologies sorted by product type](#)
- [Assistive Technology vendors with product descriptions](#)
- [Assistive Technology Industry Association \(ATIA\)](#)

Standards and legislation

Standards

Section 508 of the Federal Acquisition Regulation (FAR) standards was created by the US Access Board to address access to information and communication technology (ICT) for people with physical, sensory, or cognitive disabilities. The standards contain technical criteria specific to various types of technologies, as well as performance-based requirements which focus on functional capabilities of covered products. Specific criteria cover software applications and operating systems, web-based information and applications, computers, telecommunications products, video and multi-media, and self-contained closed products.

Mandate 376 – EN 301 549

The EN 301 549 standard was created by the European Union within Mandate 376 as the basis for an online toolkit for public procurement of ICT products. The standard specifies the functional accessibility requirements applicable to ICT products and services, together with a description of the test procedures and evaluation methodology for each accessibility requirement.

Web Content Accessibility Guidelines (WCAG)

Web Content Accessibility Guidelines (WCAG) from the W3C's Web Accessibility Initiative (WAI) helps web designers and developers create sites that better meet the needs of people with disabilities or age-related limitations. WCAG advances accessibility across the full range of web content (text, images, audio, and video) and web applications. WCAG can be precisely tested, is easy to understand and use, and allows web developers flexibility for innovation. WCAG 2.0 has also been approved as [ISO/IEC 40500:2012](#).

WCAG specifically addresses barriers to accessing the web experienced by people with visual, auditory, physical, cognitive, and neurological disabilities, and by older web users with accessibility needs. WCAG 2.0 provides characteristics of accessible content:

- **Perceivable** (for instance, by addressing text alternatives for images, captions for audio, adaptability of presentation, and color contrast)
- **Operable** (by addressing keyboard access, color contrast, timing of input, seizure avoidance, and navigability)
- **Understandable** (by addressing readability, predictability, and input assistance)
- **Robust** (for instance, by addressing compatibility with assistive technologies)

Legislation and regulations

Accessibility of IT and information has become an area of increasing legislative importance. This section provides links to information on key legislation, regulations, and standards.

- [United States](#)
- [Canada](#)
- [Europe](#)

- [United Kingdom](#)
- [Australia](#)
- [Worldwide](#)

United States

Section 508 of the Rehabilitation Act specifies that agencies must identify which standards apply to the procurement of ICT, perform market research to determine the availability of accessible products and services, and document the results of their market research. The following resources provide assistance in meeting Section 508 requirements:

- www.section508.gov
- [Buy Accessible](#)

The U.S. Access Board is currently updating the Section 508 standards. This effort will address new technologies and other areas where the standards need to be modified. For more information, go to [Section 508 Refresh](#).

Section 255 of the Telecommunications Act requires telecommunications products and services to be accessible to people with disabilities. FCC rules cover all hardware and software telephone network equipment and telecommunications equipment used in the home or office. Such equipment includes telephones, wireless handsets, fax machines, answering machines, and pagers. FCC rules also cover basic and special telecommunications services, including regular telephone calls, call waiting, speed dialing, call forwarding, computer-provided directory assistance, call monitoring, caller identification, call tracing, and repeat dialing, as well as voice mail and interactive voice response systems that provide callers with menus of choices. For more information, go to [Federal Communication Commission Section 255 information](#).

21st Century Communications and Video Accessibility Act (CVAA)

The CVAA updates federal communications law to increase the access of persons with disabilities to modern communications, updating accessibility laws enacted in the 1980s and 1990s to include new digital, broadband, and mobile innovations. Regulations are enforced by the FCC and documented as 47 CFR Part 14 and Part 79.

- [FCC Guide on the CVAA](#)

Other U.S. legislation and initiatives

- [Americans with Disabilities Act \(ADA\), Telecommunications Act, the Rehabilitation Act and others](#)

Canada

The Accessibility for Ontarians with Disabilities Act was established to develop and implement accessibility standards to make goods, services, and facilities accessible to Ontarians with disabilities and to provide for the involvement of persons with disabilities in the development of the accessibility standards. The first standard of the AODA is the customer service standard; however, standards for transportation, employment, and information and communication are also being developed. The AODA applies to the Government of Ontario, the Legislative Assembly, every designated public sector organization, and to every other person or organization that provides goods, services, or facilities to the public or other third parties and that has at least one employee in Ontario; and accessibility measures must be implemented on or before January 1, 2025. For more information, go to [Accessibility for Ontarians with Disability Act \(AODA\)](#).

Europe

EU Mandate 376 ETSI Technical Report ETSI DTR 102 612: "Human Factors (HF); European accessibility requirements for public procurement of products and services in the ICT domain (European Commission Mandate M 376, Phase 1)" has been released.

Background: The three European Standardization Organizations have set up two parallel project teams to carry out the work specified in the European Commission "Mandate 376 to CEN, CENELEC and ETSI, in Support of Accessibility Requirements for Public Procurement of Products and Services in the ICT Domain."

ETSI TC Human Factors Specialist Task Force 333 has developed ETSI DTR 102 612. Further details about the work performed by STF333 (e.g., Terms of Reference, specification of the detailed work tasks, time plan for the work, previous drafts, listing of comments received and means to contact the task force) can be found at the [Special Task Force 333](#).

The parts relating to the assessment of suitable testing and conformity schemes were carried out by a parallel project, detailed in CEN BT/WG185/PT. For further information, go to the CEN project team website. The two projects are closely coordinated.

- [CEN project team](#)
- [European Commission mandate for e-accessibility \(PDF 46KB\)](#)

United Kingdom

The Disability Discrimination Act of 1995 (DDA) was enacted to ensure that websites are accessible to blind and disabled users in the United Kingdom.

- [W3C UK Policies](#)

Australia

The Australian government has announced their plan to implement [Web Content Accessibility Guidelines 2.0](#).

All Australian government websites will require Level A compliance by 2012, and Double A by 2015. The new standard replaces WCAG 1.0, which was introduced as a mandated requirement for agencies in 2000.

Worldwide

- [JTC1 Special Working Group on Accessibility \(SWG-A\)](#)
- [G3ict: The Global Initiative for Inclusive ICT](#)
- [Italian accessibility legislation](#)
- [W3C Web Accessibility Initiative \(WAI\)](#)

Useful accessibility resources and links

The following organizations may be good resources for information about disabilities and age-related limitations.



NOTE: This is not an exhaustive list. These organizations are provided for informational purposes only. HP assumes no responsibility for information or contacts you may encounter on the Internet. Listing on this page does not imply endorsement by HP.

Organizations

- American Association of People with Disabilities (AAPD)
- The Association of Assistive Technology Act Programs (ATAP)
- Hearing Loss Association of America (HLAA)
- Information Technology Technical Assistance and Training Center (ITTATC)
- Lighthouse International
- National Association of the Deaf
- National Federation of the Blind
- Rehabilitation Engineering & Assistive Technology Society of North America (RESNA)
- Telecommunications for the Deaf and Hard of Hearing, Inc. (TDI)
- W3C Web Accessibility Initiative (WAI)

Educational institutions

- California State University, Northridge, Center on Disabilities (CSUN)
- University of Wisconsin - Madison, Trace Center
- University of Minnesota computer accommodations program

Other disability resources

- ADA (Americans with Disabilities Act) Technical Assistance Program
- Business & Disability network
- EnableMart
- European Disability Forum
- Job Accommodation Network
- Microsoft Enable
- U.S. Department of Justice - A Guide to disability rights Laws

HP links

[Our contact webform](#)

[HP comfort and safety guide](#)

[HP public sector sales](#)

Contacting support



NOTE: Support is in English only.

- Customers who are deaf or hard of hearing that have questions about technical support or accessibility of HP products:
 - Use TRS/VRS/WebCapTel to call (877) 656-7058 Monday through Friday, 6 a.m. to 9 p.m. Mountain Time.
- Customers with other disabilities or age-related limitations who have questions about technical support or accessibility of HP products, choose one of the following options:
 - Call (888) 259-5707 Monday through Friday, 6 a.m. to 9 p.m. Mountain Time.
 - Complete the [Contact form for people with disabilities or age-related limitations](#).