

Smart Signage User Manual (By Model)

This manual provides information about your Smart Signage including supported types and product specifications per model.

OMN (OM46N OM55N)

OMN-D (OM55N-D)

The colour and the appearance may differ depending on the product, and the content in the manual is subject to change without prior notice to improve the performance.

An administration fee may be charged in the following situations:

- (a) An engineer is called out at your request, but it is found that the product has no defect (i.e., where the user manual has not been read).
- (b) You bring the unit to a repair centre, but it is found that the product has no defect (i.e., where the user manual has not been read).

You will be informed of the administration fee amount before a technician visits.

Table of contents

Preparations

Checking the Components	3
Ports	4
OM46N/OM55N	4
OM55N-D	5
Anti-theft Lock	6
Before Installing the Product (Installation Guide)	7
OM46N/OM55N	7
OM55N-D	8
Installing the Wall Mount	11
Installing the Wall Mount	11
Wall Mount Kit Specifications (VESA)	11

Specifications

General	12
Preset Timing Modes	13

Appendix

Licence	15
---------	----

Chapter 01

Preparations

Checking the Components

- Contact the vendor where you purchased the product if any components are missing.
- The appearance of the components may differ from the images shown.
- A stand is not provided with the product. To install a stand, you can purchase one separately.
- Use either the back-side magnet or the double-sided tape depending on where you want to attach the external ambient light sensor. The warranty for adhesiveness of the double-sided tape applies to first-time-use only.
- The external ambient light sensor is marked with the label on the sensor cable.

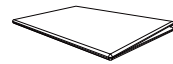

Quick Setup Guide



Warranty card
(Not available in some locations)



Regulatory guide



Power cord

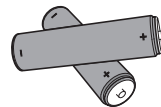

Batteries (AAA x 2)
(Not available in some locations)



Remote Control

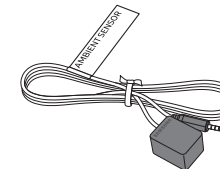

External ambient light sensor

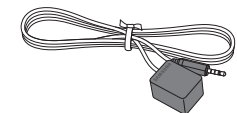

External IR cable
(OM46N, OM55N x 1 / OM55N-D x 2)



Power IN rubber
(Supported model: OM55N-D)

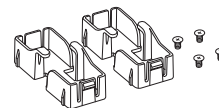

HOLDER-GUIDE x 2 / Screw (M3 x L6) x 4
(Supported model: OM55N-D)

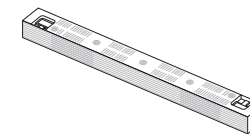

Top cover
(Supported model: OM55N-D)

Ports

OM46N/OM55N

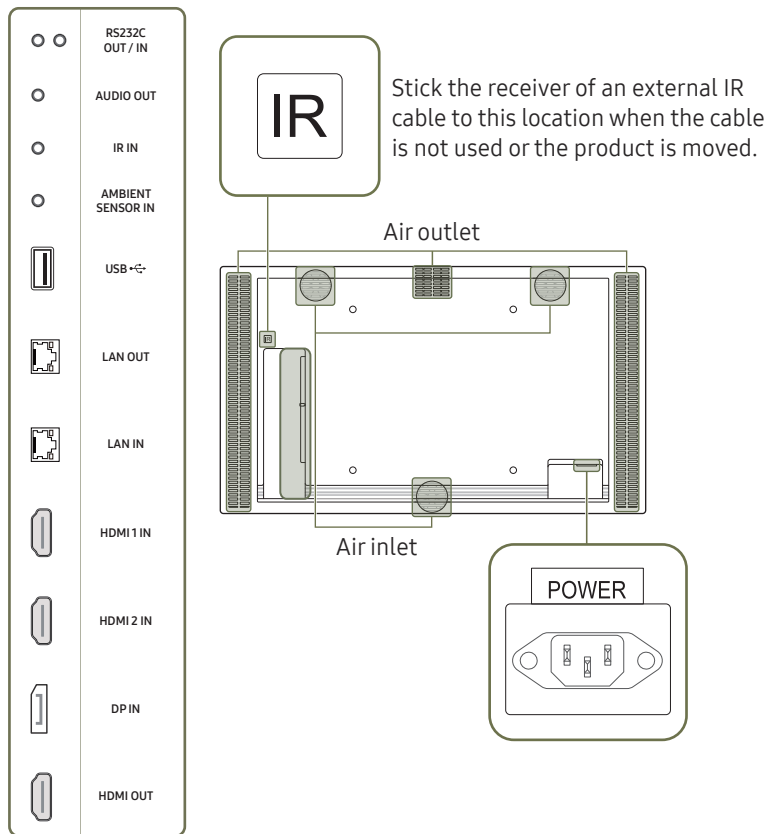



The colour and shape of parts may differ from what is shown. Specifications are subject to change without notice to improve quality.

Port	Description
RS232C OUT	Connects to MDC using an RS232C adapter.
RS232C IN	
AUDIO OUT	Outputs sound to an audio device via an audio cable.
IR IN	Connects to an external IR cable that receives signals from the remote control.
AMBIENT SENSOR IN	Used to supply power to the external sensor board and to receive signals from the ambient light sensor.
USB	Connect to a USB memory device.
LAN OUT	<ul style="list-style-type: none"> Wired LAN connection port used to connect an external device such as a laptop to connect to the Internet. Connects to MDC using a LAN cable. (10/100 Mbps)
LAN IN	Connects to MDC using a LAN cable. (10/100 Mbps)
HDMI 1 IN	Connects to a source device using a HDMI cable or HDMI-DVI cable.
HDMI 2 IN	
DP IN	Connects to a PC using a DP cable.
HDMI OUT	Connects to another product using a HDMI cable.

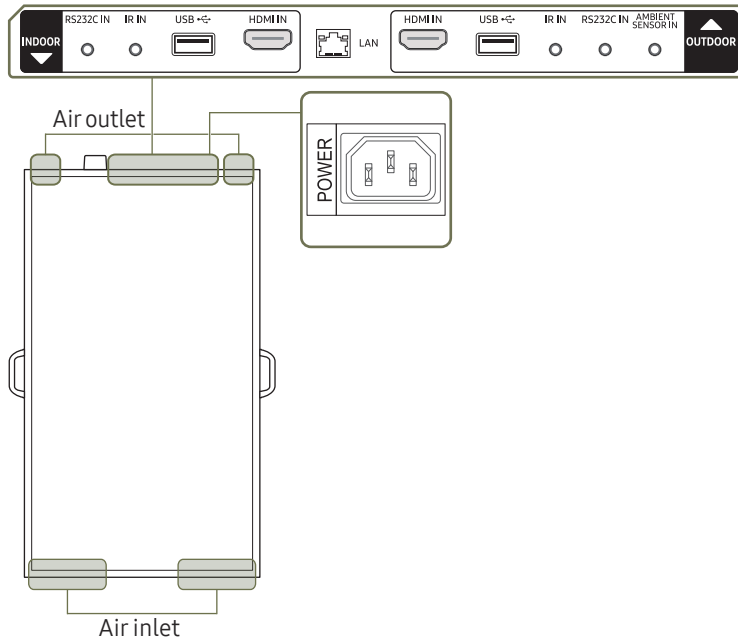
OM55N-D







-  The colour and shape of parts may differ from what is shown. Specifications are subject to change without notice to improve quality.
-  Install this product for indoors only. Install the display labelled **OUTDOOR** in the direction of the window.

Port	Description
RS232C IN	Connects to MDC using an RS232C adapter.
IR IN	Connects to an external IR cable that receives signals from the remote control.
USB 	Connect to a USB memory device.
HDMI IN	Connects to a source device using a HDMI cable or HDMI-DVI cable.
LAN	<ul style="list-style-type: none"> • Wired LAN connection port used to connect an external device such as a laptop to connect to the Internet. • Connects to MDC using a LAN cable. (10/100 Mbps)
AMBIENT SENSOR IN	Used to supply power to the external sensor board and to receive signals from the ambient light sensor.

Setting up Device ID

OM55N-D model has separate remote sensors on the front and back sides.

Depending on the distance from the remote control or other surrounding conditions, it is possible both front and back displays respond to the remote control signal. You can assign IDs to displays (INDOOR: 1, OUTDOOR: 2) and follow the steps below to restrict remote control to one selected display only.

-  To reverse the remote controlled display after setting otherwise, first cancel the existing ID settings for the INDOOR and OUTDOOR displays by pressing the **UNSET** button.
- To select the INDOOR display only
 - 1) Position the remote control facing the INDOOR IR sensor and press **SET** → **1** →  on the control.
 - 2) Position the remote control facing the OUTDOOR IR sensor and press **SET** → **1** →  on the control.
- To select the OUTDOOR display only
 - 1) Position the remote control facing the INDOOR IR sensor and press **SET** → **2** →  on the control.
 - 2) Position the remote control facing the OUTDOOR IR sensor and press **SET** → **2** →  on the control.

Anti-theft Lock

- ✎ An anti-theft lock allows you to use the product securely even in public places.
- ✎ The locking device shape and locking method depend on the manufacturer. Refer to the user guide provided with your anti-theft locking device for details.
- ✎ The following images are for reference only. Real-life situations may differ from what is shown in the images.
- ✎ Supported models: OM46N, OM55N

To lock an anti-theft locking device:

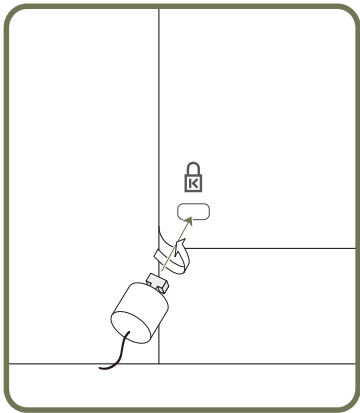

- 1 Fix the cable of your anti-theft locking device to a heavy object such as a desk.
- 2 Put one end of the cable through the loop on the other end.
- 3 Insert the locking device into the anti-theft lock slot at the back of the product.
- 4 Lock the locking device.
 - An anti-theft locking device can be purchased separately.
 - Refer to the user guide provided with your anti-theft locking device for details.
 - Anti-theft locking devices can be purchased at electronics retailers or online.

Before Installing the Product (Installation Guide)

To prevent injury, this apparatus must be securely attached to the floor/wall in accordance with the installation instructions.

- Ensure that an authorised installation company installs the wall mount.
- Otherwise, it may fall and cause personal injury.
- Make sure to install the specified wall mount.

OM46N/OM55N

Tilting Angle and Rotation

 Contact Samsung Customer Service Centre for further details.

- The product can be tilted at a maximum angle of 15° from a perpendicular wall surface.

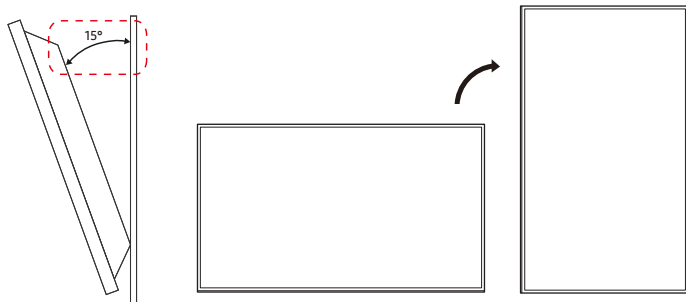

 Do not use this model installed on a ceiling, floor, or table.

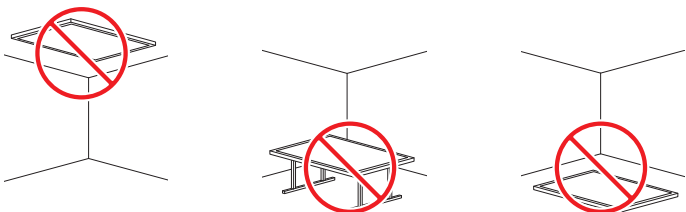

Ventilation

 Contact Samsung Customer Service Centre for further details.

Installation on a Perpendicular Wall



A Minimum 60 mm

B Ambient temperature: Under 30 °C

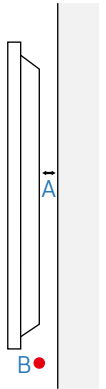
 When installing the product on a perpendicular wall, allow at least 60 mm of space between the product and wall surface for ventilation and ensure that the ambient A temperature is kept below 30 °C.



OM55N-D

-  Contact Samsung Customer Service Centre for further details.
-  Do not install this product near machinery that works with oil (e.g. gas stations). Oil mist may cause fans to malfunction.
-  Do not use in Landscape mode for this model.

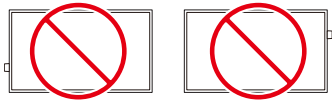

Ventilation

-  Do not block the ventilation openings on the top and bottom sides.

A Distance from the show-window > 100 mm

B Distance from the ceiling > 300 mm

C Distance from the floor > 100 mm

D Operation temperature range: 0~30 °C (under direct sunlight)

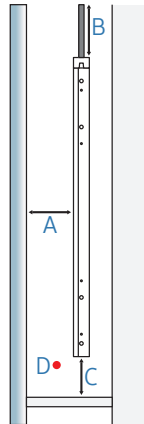

Installing the top cover

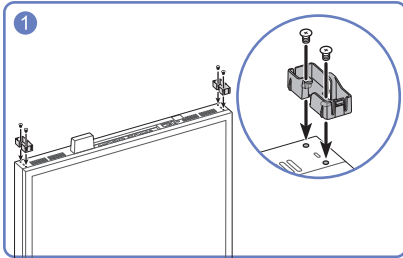

Install HOLDER-GUIDE x 2.

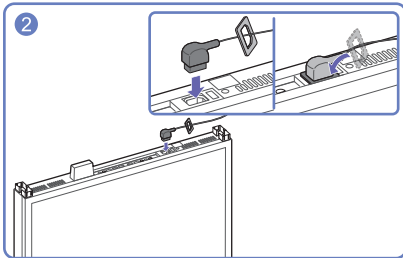

Insert the power cord into the power IN rubber and connect the power cord.

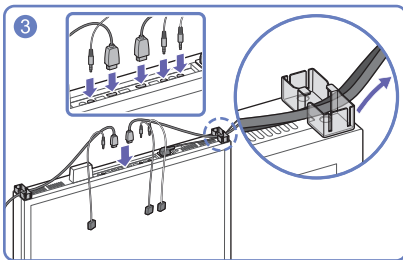

Connect cables, e.g. external IR cable, power cord, HDMI cable, and organise them as shown in the image.

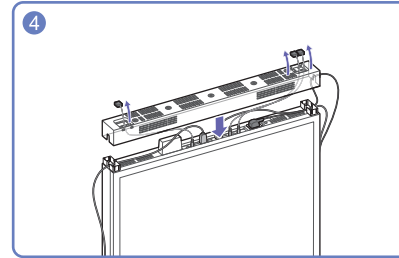

Place the top cover.

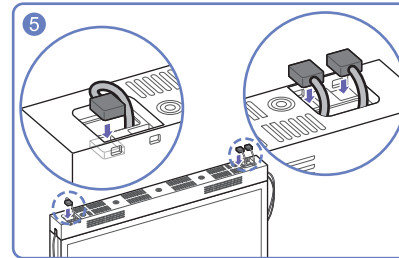

Securely position the external IR cable and the external ambient light sensor at the specified location.

Removing handles

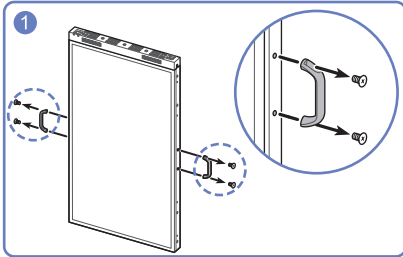

Remove the handles from both sides of the product.

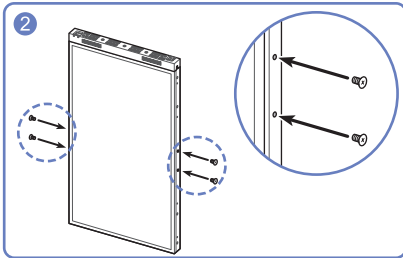

Place the screws back into the screw holes and fasten them.

 Remove the screw caps found at the marked locations before installing on the ceiling or with the stand.

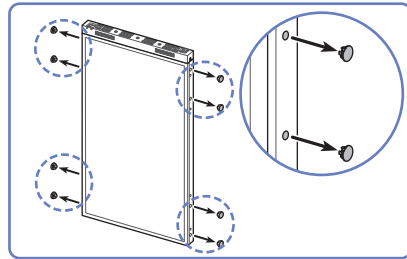

Precautions for enclosure unit installation

If you want to make additional enclosure surrounding OMN-D product, refer to the following guides.

- There should be no glass in front and back of the Enclosure.
- Don't block the top and bottom vents of OMN-D product.
- Open rate above 70% is recommended for Inlet/Outlet vent of Enclosure.

Installing the Wall Mount

 Supported models: OM46N, OM55N

Installing the Wall Mount

- The wall mount kit (sold separately) allows you to mount the product on the wall.
- The provided image is only for reference. For detailed information on installing the wall mount, see instructions provided with the wall mount.
- We recommend you contact a technician for assistance when installing the wall mount bracket.
- Samsung Electronics is not responsible for any damage to the product or injury to yourself or others if you select to install the wall mount on your own.

Wall Mount Kit Specifications (VESA)

 Install your wall mount on a solid wall perpendicular to the floor. To install the product on the other wall area, contact the nearest agency. If you install the product on a slanted wall, it may fall and result in severe personal injury.

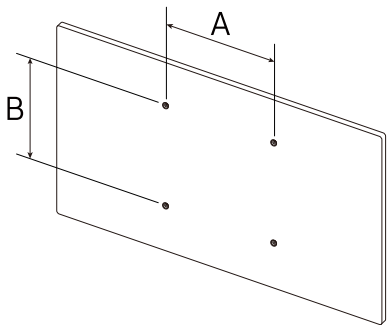

- Samsung wall mount kits contain a detailed installation manual and all parts necessary for assembly are provided.
- Do not use screws that are longer than the standard length or do not comply with the VESA standard screw specifications. Screws that are too long may cause damage to the inside of the product.
- For wall mounts that do not comply with the VESA standard screw specifications, the length of the screws may differ depending on the wall mount specifications.
- Do not fasten the screws too firmly. This may damage the product or cause the product to fall, leading to personal injury. Samsung is not liable for these kinds of accidents.
- Samsung is not liable for product damage or personal injury when a non-VESA or non-specified wall mount is used or the consumer fails to follow the product installation instructions.
- Do not mount the product at more than a 15 degree tilt.
- Always have at least two people mount the product on a wall.
- Standard dimensions for wall mount kits are shown in the table below.

Model Name	VESA screw hole specs (A * B) in millimetres	Standard Screw	Quantity
OM46N / OM55N	400 × 400	M8	4





 Do not install your Wall Mount Kit while your product is turned on. It may result in personal injury due to electric shock.

Chapter 02

Specifications

General

Model Name		OM46N	OM55N / OM55N-D
Panel	Size	46 CLASS (45.9 inches / 116.8 cm)	55 CLASS (54.6 inches / 138.7 cm)
	Display area	1018.08 mm (H) x 572.67 mm (V)	1209.6 mm (H) x 680.4 mm (V)
Power Supply		AC100-240V~ 50/60Hz Refer to the label at the back of the product as the standard voltage can vary in different countries.	
Environmental considerations	Operating	Temperature: 0 °C – 40 °C (32 °F – 104 °F) * For installing the enclosure, keep the internal temperature at 40 °C or below. Humidity: 10% – 80%, non-condensing	
	Storage	Temperature: -20 °C – 45 °C (-4 °F – 113 °F) Humidity: 5% – 95%, non-condensing * Applicable before the product package is unpacked.	

-  **Plug-and-Play**
This monitor can be installed and used with any Plug-and-Play compatible systems. Two-way data exchange between the monitor and PC system optimises the monitor settings. Monitor installation takes place automatically. However, you can customise the installation settings if desired.
-  **Due to the nature of the manufacturing of this product, approximately 1 pixel per million (1ppm) may appear brighter or darker on the panel. This does not affect product performance.**
-  **This is a class A product. In a domestic environment this product may cause radio interference in which case the user may be required to take adequate measures.**
-  **For detailed device specifications, visit the Samsung Electronics website.**

Preset Timing Modes

 This product can be set to only one resolution for each screen size to obtain the optimum picture quality due to the nature of the panel. Using a resolution other than the specified resolution may degrade the picture quality. To avoid this, it is recommended that you select the optimum resolution specified for your product.

Horizontal Frequency

The time required to scan a single line from the left to the right side of the screen is called a horizontal cycle. The reciprocal number of a horizontal cycle is called horizontal frequency. Horizontal frequency is measured in kHz.

Vertical Frequency

The product displays a single image multiple times per second (like a fluorescent light) to display what the viewer sees. The rate of a single image being displayed repeatedly per second is called vertical frequency or refresh rate. Vertical frequency is measured in Hz.

Model Name		OM46N / OM55N	OM55N-D
Synchronization	Horizontal Frequency	15 - 135 kHz (HDMI), 30 - 135 kHz (DisplayPort)	15 - 135 kHz (HDMI)
	Vertical Frequency	24 - 75 Hz (HDMI), 30 - 75 Hz (DisplayPort)	24 - 75 Hz (HDMI)
Resolution	Optimum resolution	1920 x 1080 @ 60 Hz	
	Maximum resolution	3840 x 2160 @ 60 Hz	

The screen will automatically be adjusted if a signal that belongs to the following standard signal modes is transmitted from your PC. If the signal transmitted from the PC does not belong to the standard signal modes, the screen may be blank with the power indicator on. In such a case, change the settings according to the following table by referring to the graphics card user manual.

Resolution	Horizontal Frequency (kHz)	Vertical Frequency (Hz)	Pixel Clock (MHz)	Sync Polarity (H/V)
IBM, 720 x 400	31.469	70.087	28.322	-/+
MAC, 640 x 480	35.000	66.667	30.240	-/-
MAC, 832 x 624	49.726	74.551	57.284	-/-
MAC, 1152 x 870	68.681	75.062	100.000	-/-
VESA, 640 x 480	31.469	59.940	25.175	-/-
VESA, 640 x 480	37.861	72.809	31.500	-/-
VESA, 640 x 480	37.500	75.000	31.500	-/-
VESA, 800 x 600	35.156	56.250	36.000	+/+
VESA, 800 x 600	37.879	60.317	40.000	+/+
VESA, 800 x 600	48.077	72.188	50.000	+/+
VESA, 800 x 600	46.875	75.000	49.500	+/+
VESA, 1024 x 768	48.363	60.004	65.000	-/-
VESA, 1024 x 768	56.476	70.069	75.000	-/-
VESA, 1024 x 768	60.023	75.029	78.750	+/+
VESA, 1152 x 864	67.500	75.000	108.000	+/+

Resolution	Horizontal Frequency (kHz)	Vertical Frequency (Hz)	Pixel Clock (MHz)	Sync Polarity (H/V)
VESA, 1280 x 720	45.000	60.000	74.250	+/+
VESA, 1280 x 800	49.702	59.810	83.500	-/+
VESA, 1280 x 1024	63.981	60.020	108.000	+/+
VESA, 1280 x 1024	79.976	75.025	135.000	+/+
VESA, 1366 x 768	47.712	59.790	85.500	+/+
VESA, 1440 x 900	55.935	59.887	106.500	-/+
VESA, 1600 x 900	60.000	60.000	108.000	+/+
VESA, 1680 x 1050	65.290	59.954	146.250	-/+
VESA, 1920 x 1080	67.500	60.000	148.500	+/+
VESA, 2560 x 1440	88.787	59.951	241.500	+/-
CEA, 3840 x 2160 (HDMI)	67.500	60.000	297.000	+/+
VESA, 3840 x 2160 (DP)	133.313	59.997	533.250	+/-

 The OMN-D models are not available in the VESA 3840 x 2160 (DP).

Chapter 03

Appendix

Licence



Manufactured under license from Dolby Laboratories. Dolby, Dolby Audio, Pro Logic, and the double-D symbol are trademarks of Dolby Laboratories.

 Supported models: OM46N, OM55N



The terms HDMI and HDMI High-Definition Multimedia Interface, and the HDMI Logo are trademarks or registered trademarks of HDMI Licensing LLC in the United States and other countries.

Open Source Licence Notice

In the case of using open source software, Open Source Licences are available on the product menu. Open Source Licence Notice is written only English.

For information on the Open Source Licence Notice, contact the Samsung Customer Centre or send email to oss.request@samsung.com.



THIS PRODUCT IS SOLD WITH A LIMITED LICENCE AND IS AUTHORISED TO BE USED ONLY IN CONNECTION WITH HEVC CONTENT THAT MEETS EACH OF THE THREE FOLLOWING QUALIFICATIONS: (1) HEVC CONTENT ONLY FOR PERSONAL USE; (2) HEVC CONTENT THAT IS NOT OFFERED FOR SALE; AND (3) HEVC CONTENT THAT IS CREATED BY THE OWNER OF THE PRODUCT.

THIS PRODUCT MAY NOT BE USED IN CONNECTION WITH HEVC ENCODED CONTENT CREATED BY A THIRD PARTY, WHICH THE USER HAS ORDERED OR PURCHASED FROM A THIRD PARTY, UNLESS THE USER IS SEPARATELY GRANTED RIGHTS TO USE THE PRODUCT WITH SUCH CONTENT BY A LICENSED SELLER OF THE CONTENT.

YOUR USE OF THIS PRODUCT IN CONNECTION WITH HEVC ENCODED CONTENT IS DEEMED ACCEPTANCE OF THE LIMITED AUTHORITY TO USE AS NOTED ABOVE.
