

HyperX Alloy Elite Mechanical Gaming Keyboard

Find the language and latest documentation for your HyperX Alloy Elite Mechanical Gaming Keyboard here.

HyperX Alloy Elite Mechanical Gaming Keyboard User Manual

-  For instructions in English
-  Para instrucciones en Español
-  Für Anleitungen in Deutsch
-  Pour des instructions en Français
-  Per le istruzioni in Italiano
-  Por as instruções em Português
-  Instrukcje w języku polskim
-  Для инструкции на русском
-  Turkce talimatlar icin
-  Japanese
-  Korean
-  Thai
-  Vietnamese
- Simplified Chinese 中文说明
- Traditional Chinese 中文說明



HyperX Alloy Elite Mechanical Gaming Keyboard



Part Numbers		
Cherry® MX Blue	Cherry® MX Brown	Cherry® MX Red
HX-KB2BL1-UK/R1	HX-KB2BR1-UK/R1	HX-KB2RD1-UK/R1
HX-KB2BL1-FR/R1	HX-KB2BR1-FR/R1	HX-KB2RD1-FR/R1
HX-KB2BL1-DE/R1	HX-KB2BR1-DE/R1	HX-KB2RD1-DE/R1
HX-KB2BL1-NO/R1	HX-KB2BR1-NO/R1	HX-KB2RD1-NO/R1
HX-KB2BL1-RU/R1	HX-KB2BR1-RU/R1	HX-KB2RD1-RU/R1
HX-KB2BL1-LA/R2	HX-KB2BR1-LA/R2	HX-KB2RD1-LA/R2
HX-KB2BL1-US/R1	HX-KB2BR1-US/R1	HX-KB2RD1-US/R1
HX-KB2BL1-US/R2	HX-KB2BR1-US/R2	HX-KB2RD1-US/R2



What's included:







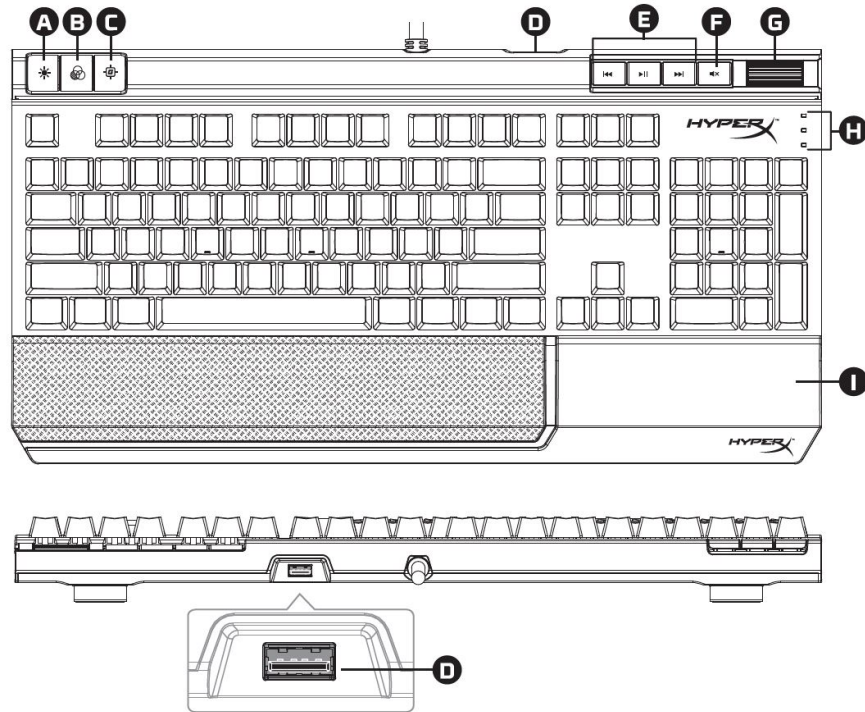

- HyperX Alloy Elite Mechanical Gaming Keyboard
- 8x Gaming keycaps
- Keycaps puller
- Wrist rest





Keyboard Overview:

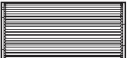

- A- Brightness control button 
- B- LED mode control button 
- C- Game Mode button 
- D- Back USB port (USB 2.0 pass-through) 
- E- Media control buttons 
- F- Volume mute button 
- G- Volume control wheel 
- H- Game Mode / Num Lock / Caps Lock indicators 
- I- Detachable wrist rest





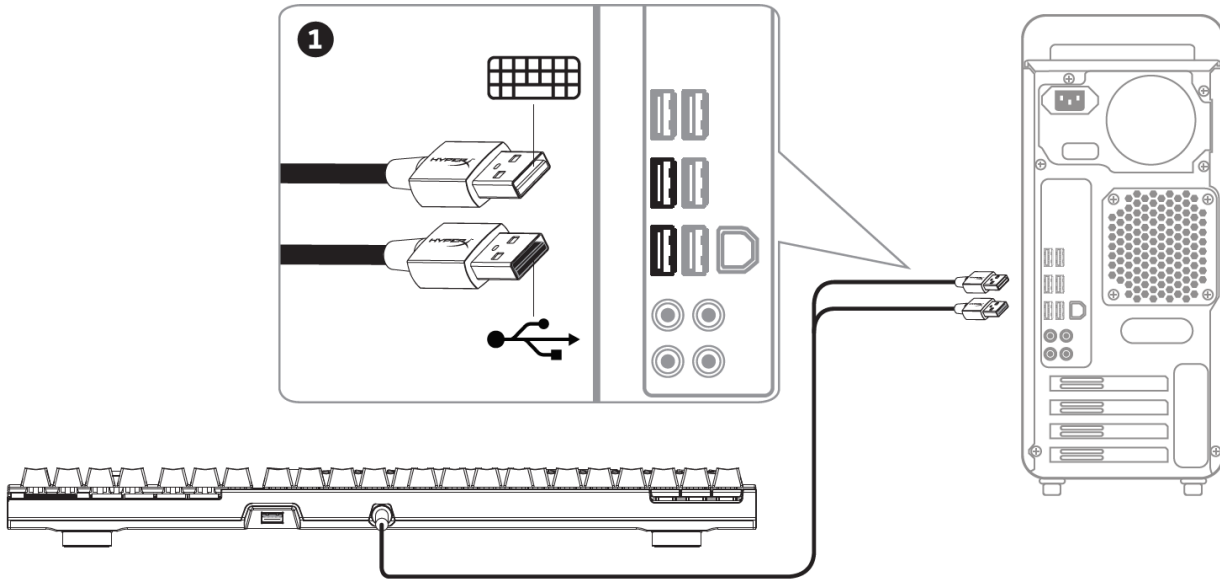







Keyboard Installation:



1- Connect both USB connectors to the computer.

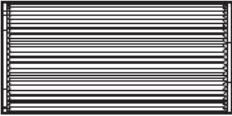

Function Keys:

Function Keys	Secondary Feature
	<p>Change the LED Backlight brightness. There are 4 levels of brightness: OFF, low, medium and high.</p>
	<p>Switch between the LED backlight modes.</p>
	<p>Enable Game Mode  to disable the Windows key and prevent accidental interruption during gaming. When Game Mode is enabled the indicator will illuminate.</p>
	<p>Play/pause , skip backwards  or skip forward  while listening to music or watching videos.</p>
	<p>Mute  computer audio.</p>
	<p>Increase or decrease computer audio volume.</p>



LED backlight modes:

There are six LED backlight modes: ► Solid (default) ► Breathing ► Trigger ► Explosion ► Wave ► Custom.



1- Solid: Constant lighting (default setting).



2- Breathing: Slow rhythmic blinking that mimics breathing.



3- Trigger: Individual keys will light up when pressed and slowly fade after one second.



4- Explosion: A lighting effect will radiate from individual keys when pressed.





5- Wave: Keys will light up from left to right in a wave pattern.



6- Custom: You can choose which keys you want to light up.

Follow these steps to customize:

- 1- Switch the backlight mode to Custom.

2- Hold  +  until the backlight turns off.

- 3- Press the key or keys you want to have backlight ON.

4- When finished, press  +  again to save your custom backlight profile.



Keyboard factory reset:

If you are experiencing any issue with the keyboard you can perform a factory reset. You will lose your custom LED profile by doing this.

Function Keys	Secondary Feature
	Press all three keys simultaneously until the keyboard LED backlight blinks twice.



Teclado mecánico para videojuegos HyperX Alloy Elite



Números de pieza		
Cherry® MX azul	Cherry® MX marrón	Cherry® MX rojo
HX-KB2BL1-UK/R1	HX-KB2BR1-UK/R1	HX-KB2RD1-UK/R1
HX-KB2BL1-FR/R1	HX-KB2BR1-FR/R1	HX-KB2RD1-FR/R1
HX-KB2BL1-DE/R1	HX-KB2BR1-DE/R1	HX-KB2RD1-DE/R1
HX-KB2BL1-NO/R1	HX-KB2BR1-NO/R1	HX-KB2RD1-NO/R1
HX-KB2BL1-RU/R1	HX-KB2BR1-RU/R1	HX-KB2RD1-RU/R1
HX-KB2BL1-LA/R2	HX-KB2BR1-LA/R2	HX-KB2RD1-LA/R2
HX-KB2BL1-US/R1	HX-KB2BR1-US/R1	HX-KB2RD1-US/R1
HX-KB2BL1-US/R2	HX-KB2BR1-US/R2	HX-KB2RD1-US/R2

**Elementos incluidos:**







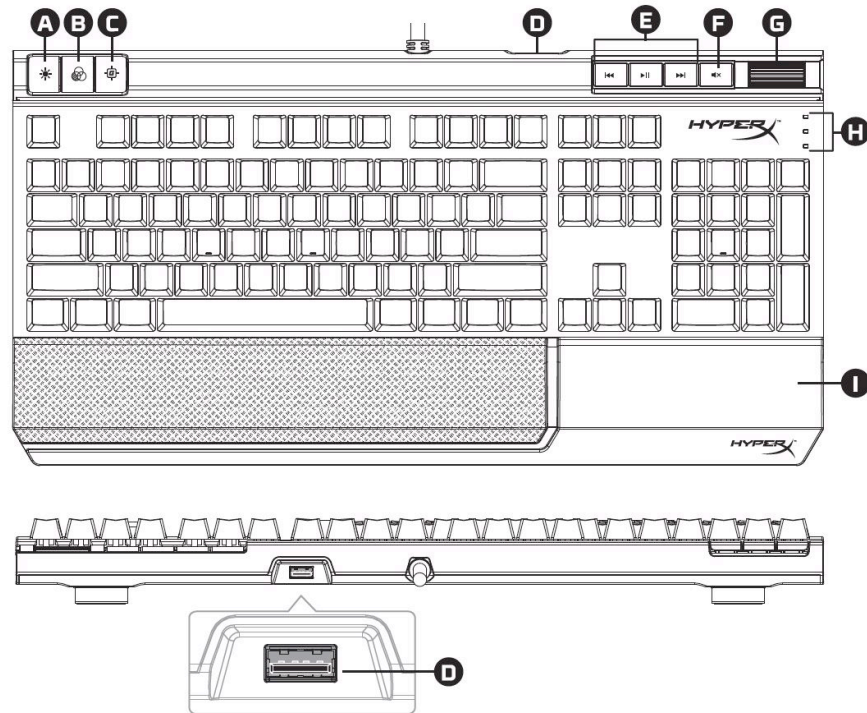

- Teclado mecánico para videojuegos HyperX Alloy Elite
- Teclas de juego 8x
- Extractor de teclas
- Reposamuñecas





Descripción general del teclado:

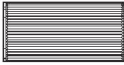

- A- Botón de control del brillo 
- B- Botón de control del modo LED 
- C- Botón de modo de juego 
- D- Puerto USB posterior (conector USB 2.0) 
- E- Botones de control multimedia 
- F- Botón de silenciación del volumen 
- G- Rueda de control de volumen 
- H- Indicadores de modo Juego/Bloq Num/Bloq Mayús 
- I- Reposamuñecas desmontable





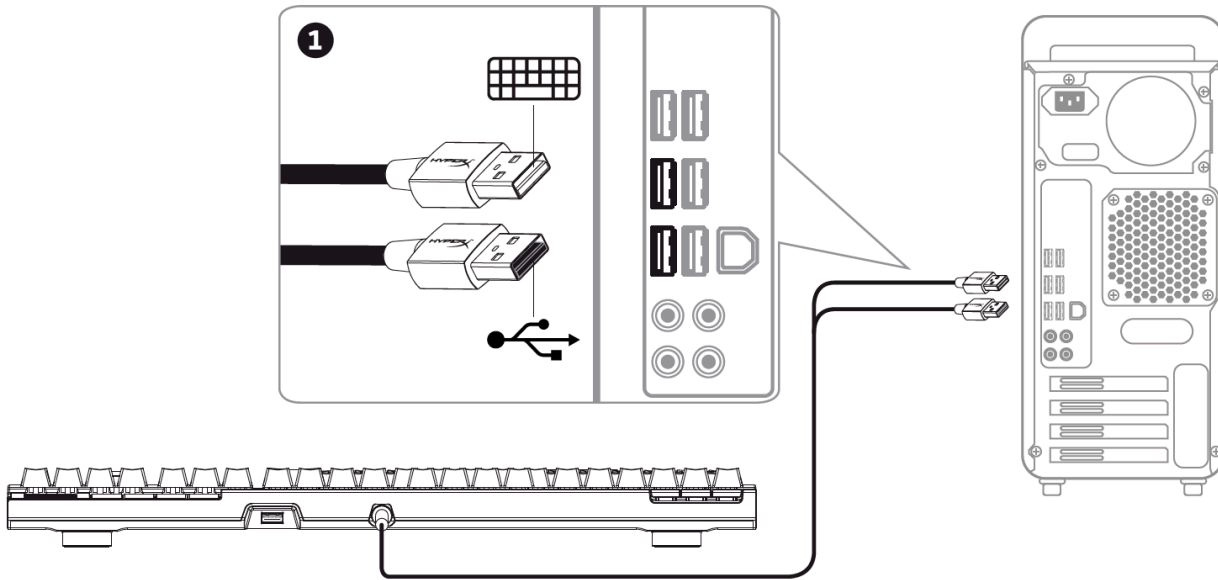





Instalación del teclado:

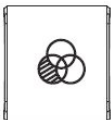

1- Conecta ambos conectores USB al ordenador.

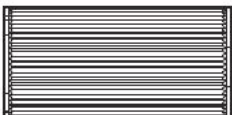

Teclas de función:

Teclas de función	Función secundaria
	<p>Cambia el brillo de la retroiluminación LED. Existen cuatro niveles de brillo: DESCONNECTADO, bajo, medio y alto.</p>
	<p>Cambia entre los modos de retroiluminación LED.</p>
	<p>Activa el modo de juego  para desactivar la tecla de Windows y evitar interrupciones accidentales durante el juego. Al activar el modo Juego, el indicador se iluminará.</p>
	<p>Reproduce/pon en pausa , avanza hacia atrás  o avanza hacia adelante  mientras escuchas música o miras vídeos.</p>
	<p>Audio del ordenador en silencio .</p>
	<p>Sube o baja el volumen de audio del ordenador.</p>



Modos de retroiluminación LED:

Existen seis modos de retroiluminación LED: ► Sólido (predeterminado) ► Respiración ► Desencadenante ► Explosión ► Onda ► Personalizado.



Sólido: Iluminación constante (configuración predeterminada).



Respiración: Parpadeo rítmico lento que imita la respiración.



Desencadenante: Las teclas se iluminarán al pulsarlo y se apagarán gradualmente al cabo de un segundo.



Explosión: Se emitirá un efecto de iluminación al pulsar las teclas.



Onda: Las teclas se encenderán de izquierda a derecha como una onda.



Personalizado: Puedes elegir qué teclas deseas que se enciendan.

Para realizar la personalización, sigue estos pasos:

- 1- Cambia el modo de retroiluminación a Personalizado.

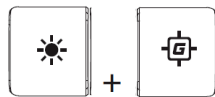

- 2- Mantén pulsado [Sun icon] + [Gear icon] hasta que se apague la retroiluminación.

- 3- Pulsa la tecla o teclas que deseas que se retroiluminen.

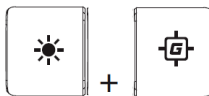

- 4- Cuando hayas acabado, pulsa [Sun icon] + [Gear icon] de nuevo para guardar tu perfil de retroiluminación personalizado.

**Restablecimiento de fábrica del teclado:**

Si tienes algún problema con el teclado, puedes realizar un restablecimiento de fábrica. Al hacerlo perderás tu perfil LED personalizado.

Teclas de función	Función secundaria
	<p>Pulsa las tres teclas de forma simultánea hasta que la retroiluminación LED del teclado parpadee dos veces.</p>



HyperX Alloy Elite Mechanische Gaming-Tastatur



Artikelnummern		
Cherry® MX Blue	Cherry® MX Brown	Cherry® MX Red
HX-KB2BL1-UK/R1	HX-KB2BR1-UK/R1	HX-KB2RD1-UK/R1
HX-KB2BL1-FR/R1	HX-KB2BR1-FR/R1	HX-KB2RD1-FR/R1
HX-KB2BL1-DE/R1	HX-KB2BR1-DE/R1	HX-KB2RD1-DE/R1
HX-KB2BL1-NO/R1	HX-KB2BR1-NO/R1	HX-KB2RD1-NO/R1
HX-KB2BL1-RU/R1	HX-KB2BR1-RU/R1	HX-KB2RD1-RU/R1
HX-KB2BL1-LA/R2	HX-KB2BR1-LA/R2	HX-KB2RD1-LA/R2
HX-KB2BL1-US/R1	HX-KB2BR1-US/R1	HX-KB2RD1-US/R1
HX-KB2BL1-US/R2	HX-KB2BR1-US/R2	HX-KB2RD1-US/R2

**Im Lieferumfang:**







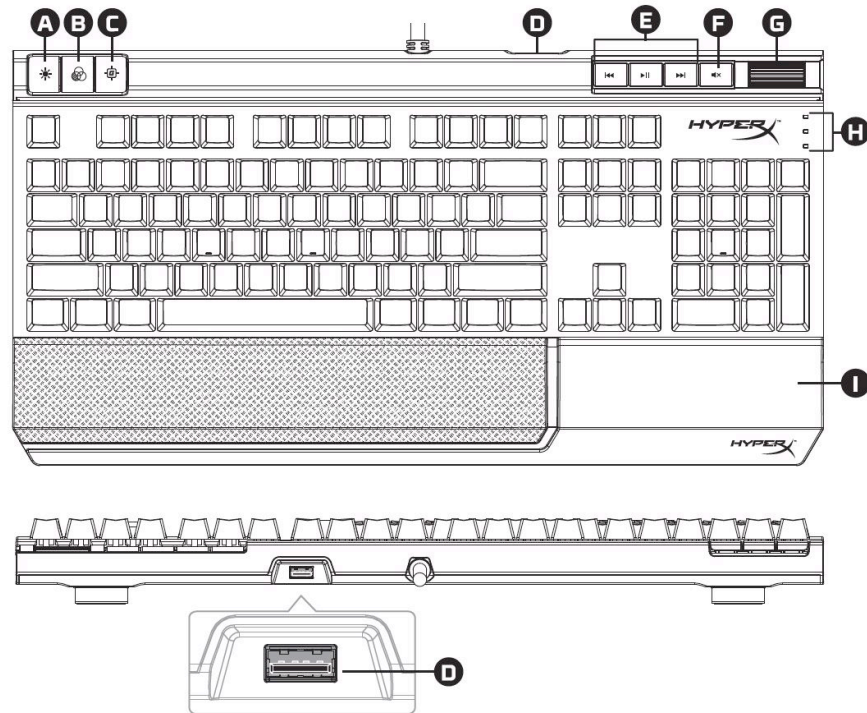

- HyperX Alloy Elite Mechanische Gaming-Tastatur
- 8 Gaming-Keycaps
- Werkzeug zum Entfernen der Keycaps
- Handballen-Auflage





Tastaturübersicht

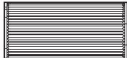

- A- Taste für die Helligkeitssteuerung 
- B- Taste für die LED-Steuerung 
- C- Spielmodustaste 
- D- Rückseitiger USB-Anschluss (USB 2.0 Pass-Through) 
- E- Mediensteuerungstasten 
- F- Stummschalttaste 
- G- Lautstärkeregler 
- H- Anzeige für Spielmodus / Num / Feststelltaste  1 A
- I- Abnehmbare Handballenauflage





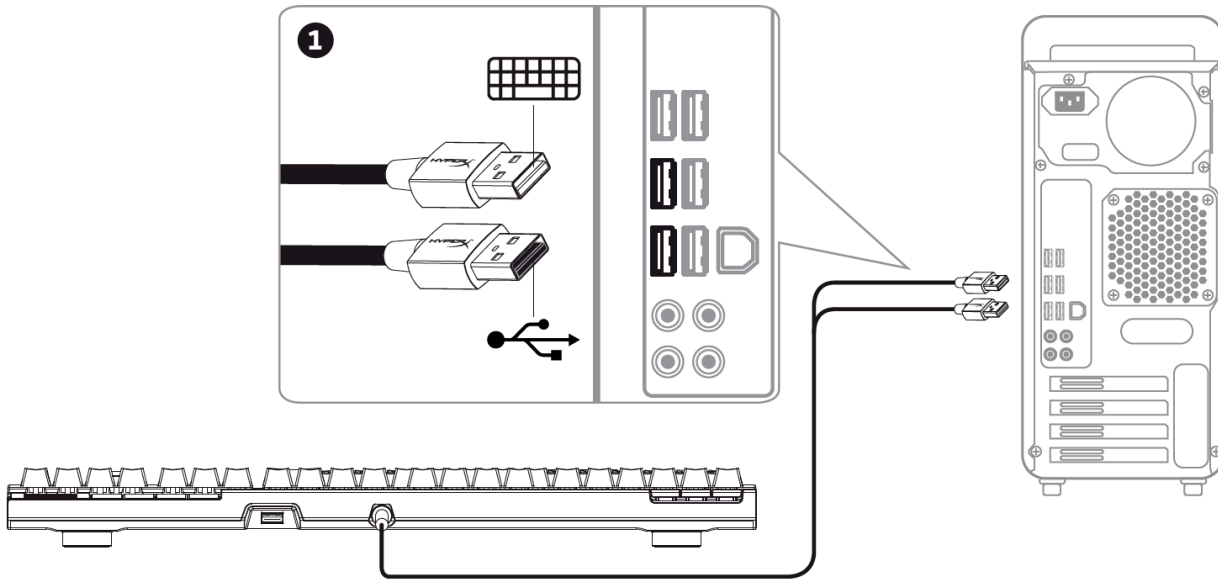





Installation der Tastatur

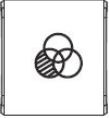

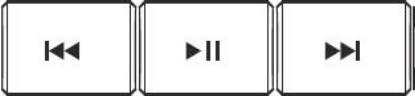
1- Verbinde beide USB-Stecker mit dem Computer.

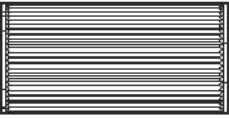

Funktionstasten:

Funktionstasten	Zweitfunktion
	<p>Ändern der LED-Hintergrundbeleuchtung Es gibt 4 Helligkeitsstufen: AUS, gering, mittel und hoch.</p>
	<p>Wechsle zwischen den einzelnen LED-Modi</p>
	<p>Aktiviere den Spielmodus,  um die Windows-Taste zu deaktivieren und eine versehentliche Unterbrechung während des Spielens zu verhindern. Wenn der Spielmodus aktiv ist, leuchtet die entsprechende Anzeige.</p>
	<p>Wiedergabe/Pause , vorwärts  oder rückwärts springen,  während du Musik hörst oder Videos anschaust.</p>
	<p>Den Ton  stummschalten</p>
	<p>Erhöhe oder verringere die Lautstärke des Computers.</p>



Modi für LED-Hintergrundbeleuchtung:

Es gibt sechs Modi für die LED-Hintergrundbeleuchtung: ► Durchgehend (Standardeinstellung) ► Atmung ► Auslöser ► Explosion ► Welle ► Benutzerdefiniert.



Durchgehend: Konstante Beleuchtung (Standardeinstellung).



Atmung: Langsames rhythmisches Blinken, das die Atmung simuliert.



Auslöser: Die einzelnen Tasten leuchten bei Betätigung auf, die Beleuchtung lässt nach einer Sekunde nach.



Explosion: Ein Lichteffect geht bei Betätigung von den einzelnen Tasten aus.



Welle: Die Tasten leuchten wellenartig von links nach rechts auf.



Benutzerdefiniert: Du legst fest, welche Tasten beleuchtet werden.

Führe die folgenden Schritte aus, um die Beleuchtung anzupassen:

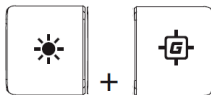

- 1- Schalte die Hintergrundbeleuchtung in den Modus „Benutzerdefiniert“.

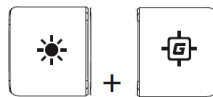

- 2- Halte  + , bis die Hintergrundbeleuchtung ausgeht.

- 3- Drücke die Taste bzw. die Tasten, für die Du die Hintergrundbeleuchtung einschalten möchtest.



- 4- Wenn du fertig bist, drücke  +  erneut, um dein benutzerdefiniertes Hintergrundbeleuchtungsprofil zu speichern.



Werkseinstellungen für Tastatur

Wenn du Probleme mit deiner Tastatur bekommst, kannst du sie auf die Werkseinstellungen zurücksetzen. Dadurch gehen deine individuellen LED-Einstellungen verloren.

Funktionstasten	Zweitfunktion
	Drücke alle drei Tasten gleichzeitig, bis die LED-Hintergrundbeleuchtung der Tastatur zweimal aufblinkt.



Clavier de jeu mécanique HyperX Alloy Elite



Références produits

Cherry® MX Blue	Cherry® MX Brown	Cherry® MX Red
HX-KB2BL1-UK/R1	HX-KB2BR1-UK/R1	HX-KB2RD1-UK/R1
HX-KB2BL1-FR/R1	HX-KB2BR1-FR/R1	HX-KB2RD1-FR/R1
HX-KB2BL1-DE/R1	HX-KB2BR1-DE/R1	HX-KB2RD1-DE/R1
HX-KB2BL1-NO/R1	HX-KB2BR1-NO/R1	HX-KB2RD1-NO/R1
HX-KB2BL1-RU/R1	HX-KB2BR1-RU/R1	HX-KB2RD1-RU/R1
HX-KB2BL1-LA/R2	HX-KB2BR1-LA/R2	HX-KB2RD1-LA/R2
HX-KB2BL1-US/R1	HX-KB2BR1-US/R1	HX-KB2RD1-US/R1
HX-KB2BL1-US/R2	HX-KB2BR1-US/R2	HX-KB2RD1-US/R2



Le produit inclut :

- Clavier de jeu mécanique HyperX Alloy Elite
- 8 touches de jeu
- Clé de démontage des touches
- Repose-poignet





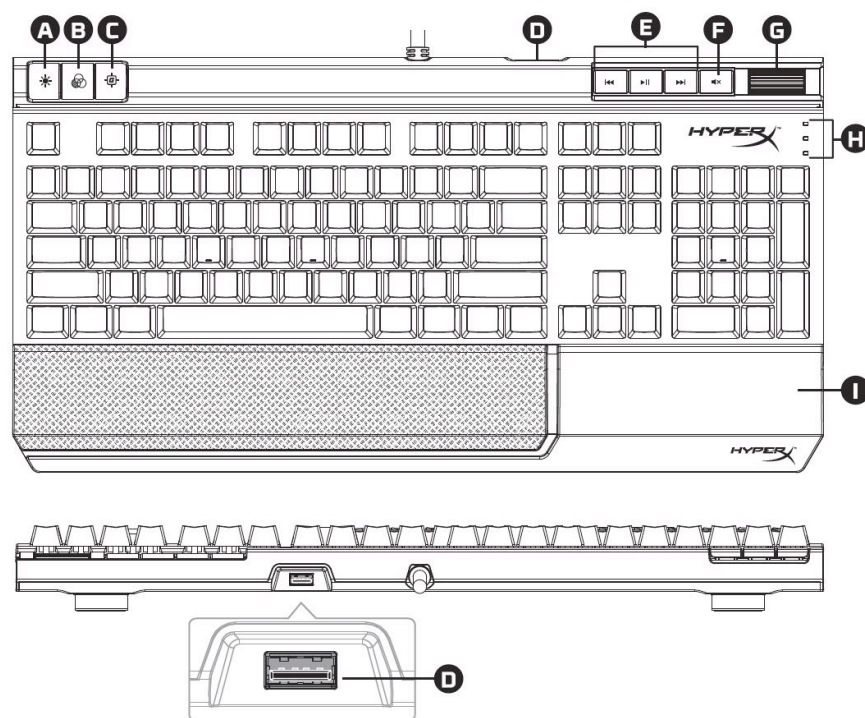

Présentation du clavier :



A- Bouton de contrôle de la luminosité 

B- Bouton de sélection du mode LED 

C- Bouton du mode Jeu 

D- Port USB arrière (transfert USB 2.0) 

E- Boutons de contrôle Multimédia 

F- Bouton de désactivation du volume 

G- Roulette de réglage du volume 

H- Témoins lumineux : mode Jeu / Verrouillage du clavier numérique / Verrouillage de la

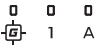
touche Majuscule 

I- Repose-poignet amovible





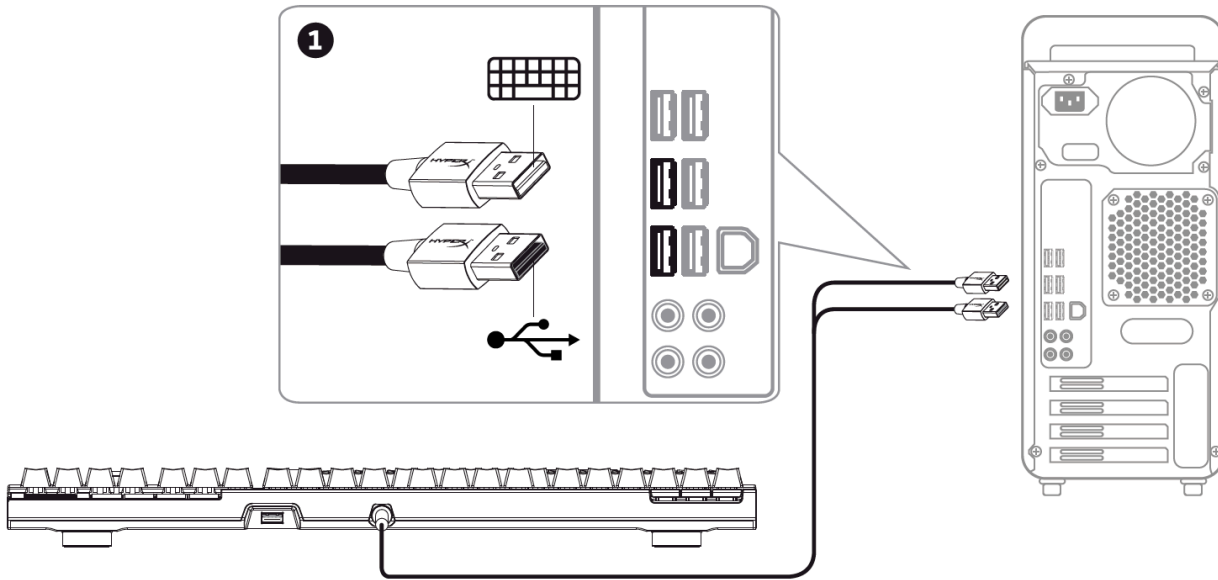





Installation du clavier :

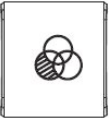

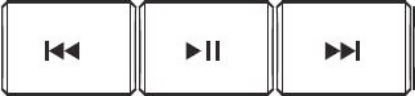
1- Branchez les deux connecteurs USB à l'ordinateur.

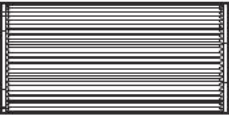

Touches de fonction :

Touches de fonction	Fonction secondaire
	<p>Régler la luminosité du rétroéclairage LED. Quatre niveaux de luminosité sont disponibles : éteint, bas, moyen, élevé.</p>
	<p>Sélectionner un des modes de rétroéclairage LED :</p>
	<p>Activer le mode Jeu  pour désactiver la touche Windows et éviter des interruptions accidentelles pendant les jeux. Lorsque le mode Jeu est activé, le voyant Jeu est allumé.</p>
	<p>Lecture/pause  II, Retour rapide  ou Avance rapide  pendant la lecture d'un fichier audio ou vidéo.</p>
	<p>Coupure  de l'audio du PC.</p>
	<p>Augmenter ou diminuer le volume audio du PC.</p>



Mode de rétroéclairage LED :

Six modes de rétroéclairage LED sont disponibles : ► Fixe (par défaut) ► Respiration ► Déclenchement ► Explosion ► Onde ► Personnalisation.



Fixe : Éclairage constant (valeur par défaut).



Respiration : Clignotement lent qui imite la respiration.



Déclenchement : Les touches s'allument individuellement lorsqu'elles sont pressées et s'éteignent progressivement après une seconde.



Explosion : Un effet lumineux rayonne à chaque pression sur une touche.



Onde : Les touches s'allument de gauche à droite en formant une onde lumineuse.



Personnalisation : Vous choisissez les touches qui doivent s'allumer.

Pour personnaliser, suivez les instructions ci-dessous :

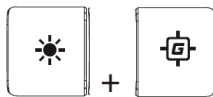

- 1- Activez le mode d'éclairage Personnalisation.

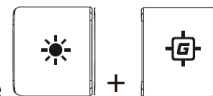

- 2- Appuyez sur la touche  +  jusqu'à ce que le rétroéclairage s'éteigne.

- 3- Appuyez sur la ou les touches pour lesquelles vous souhaitez activer le rétroéclairage.



- 4- Lorsque vous avez terminé, appuyez à nouveau sur la touche  +  pour enregistrer votre configuration du rétroéclairage personnalisé.

**Réinitialisation d'usine :**

Si vous rencontrez un problème pendant l'utilisation du clavier, vous pouvez le réinitialiser pour rétablir sa configuration d'usine. Cette réinitialisation efface tous les paramètres de personnalisation LED.

Touches de fonction	Fonction secondaire
	Maintenez les trois touches enfoncées simultanément jusqu'à ce que le rétroéclairage du clavier clignote deux fois.



Tastiera meccanica per il gaming HyperX Alloy Elite



Numeri di parte		
Cherry® MX Blue	Cherry® MX Brown	Cherry® MX Red
HX-KB2BL1-UK/R1	HX-KB2BR1-UK/R1	HX-KB2RD1-UK/R1
HX-KB2BL1-FR/R1	HX-KB2BR1-FR/R1	HX-KB2RD1-FR/R1
HX-KB2BL1-DE/R1	HX-KB2BR1-DE/R1	HX-KB2RD1-DE/R1
HX-KB2BL1-NO/R1	HX-KB2BR1-NO/R1	HX-KB2RD1-NO/R1
HX-KB2BL1-RU/R1	HX-KB2BR1-RU/R1	HX-KB2RD1-RU/R1
HX-KB2BL1-LA/R2	HX-KB2BR1-LA/R2	HX-KB2RD1-LA/R2
HX-KB2BL1-US/R1	HX-KB2BR1-US/R1	HX-KB2RD1-US/R1
HX-KB2BL1-US/R2	HX-KB2BR1-US/R2	HX-KB2RD1-US/R2

**Contenuto della confezione:**







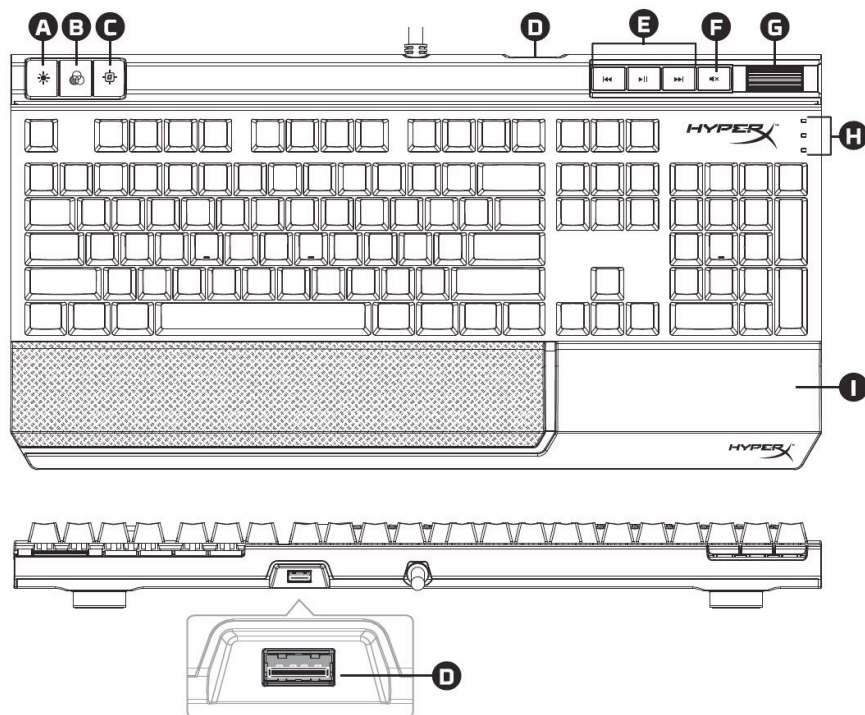

- Tastiera meccanica per il gaming HyperX Alloy Elite
- 8 copritasti per gaming
- Estrattore copritasti
- Poggiapolsi





Panoramica sulla tastiera:

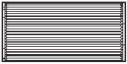

- A- Pulsante di controllo della luminosità 
- B- Pulsante di controllo della modalità LED 
- C- Pulsante modalità Game 
- D- Porta posteriore USB (USB 2.0 pass-through) 
- E- Pulsanti di controllo multimediale 
- F- Pulsante di silenziamento volume 
- G- Manopola di regolazione del volume 
- H- Indicatori Modalità Game / Bloc Num / Bloc Maiusc 
- I- Poggiapolsi scollegabile





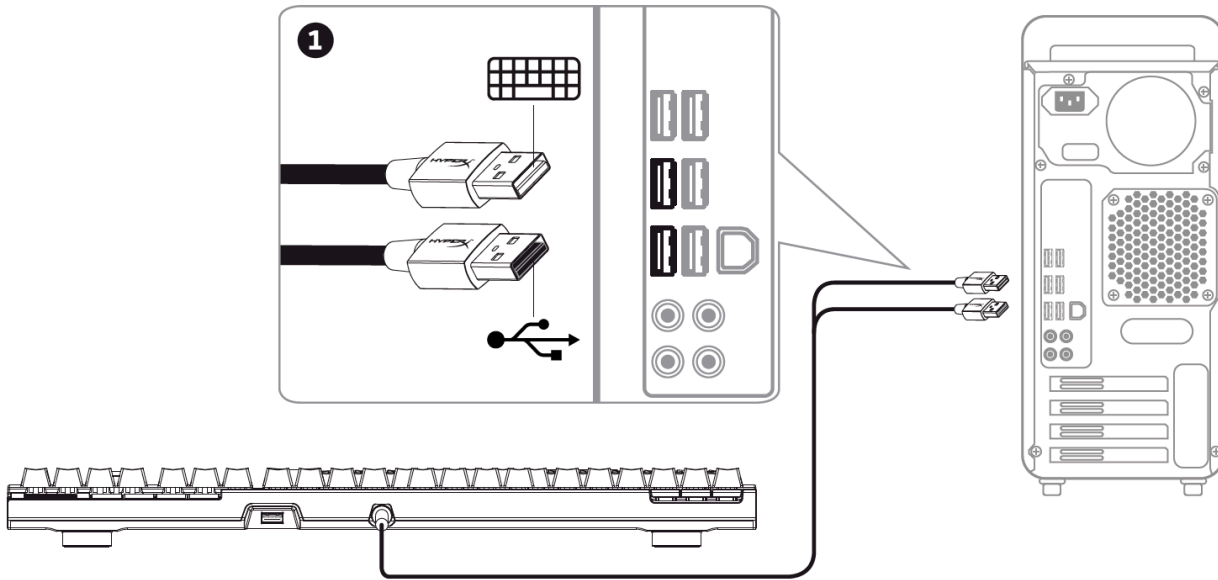



Installazione rapida:



1- Inserire entrambi i connettori USB nel computer.

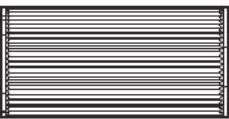

Tasti funzione:

Tasti funzione	Funzionalità prevista
	<p>Regola la luminosità della retroilluminazione LED. Sono previsti 4 livelli di luminosità: spento, basso, medio e alto.</p>
	<p>Alterna le diverse modalità di retroilluminazione LED.</p>
	<p>Attiva la modalità Game  per disattivare il tasto Windows ed evitare interruzioni involontarie del gioco. L'indicatore si illumina quando la modalità Game è attivata.</p>
	<p>Funzioni play/pause ► , avanti◀◀ o indietro▶▶ relative all'ascolto di musica o riproduzione di video.</p>
	<p>Disattiva  l'audio del computer.</p>
	<p>Aumenta o riduce il volume dell'audio del computer.</p>



Modalità retroilluminazione LED:

Sono previsti 6 modalità di retroilluminazione LED: ► Fissa (predefinita) ► Respiro ► Pressione ► Esplosione ► Onda ► Personalizzato.



Fissa: illuminazione costante (impostazioni di default).



Respiro: lampeggio lento che ricorda l'immagine di un respiro.



Pressione: i singoli tasti si illuminano appena premuti per poi spegnersi lentamente dopo la pressione.



Esplosione: da ogni tasto premuto parte un effetto luminoso che si irradia in tutte le direzioni.



Onda: i tasti si illuminano insieme da sinistra verso destra, simulando il passaggio di un'onda.



Personalizzato: è possibile decidere quali tasti illuminare.

Per eseguire la personalizzazione:

- 1- Passare alla modalità Personalizzato

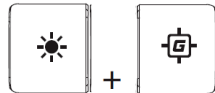

- 2- Tenere premuto [sun icon] + [plus icon] fino a quando verrà disattivata la retroilluminazione.

- 3- Premere il tasto o i tasti per cui si desidera attivare la retroilluminazione.

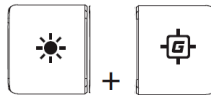

- 4- Al termine, premere nuovamente [sun icon] + [plus icon] per salvare il profilo di retroilluminazione personalizzato.

**Ripristino opzioni di fabbrica:**

Nel caso si verificano problemi nell'utilizzo della tastiera, è possibile ripristinare le opzioni di fabbrica. In questo caso, tutte le impostazioni di personalizzazione del profilo LED saranno eliminate.

Tasti funzione	Funzionalità prevista
	Premere contemporaneamente i tre tasti fino a quando la retroilluminazione della tastiera lampeggerà due volte.



Teclado Mecânico de Gaming HyperX Alloy Elite



Referências		
Azul Cherry® MX	Castanho Cherry® MX	Vermelho Cherry® MX
HX-KB2BL1-UK/R1	HX-KB2BR1-UK/R1	HX-KB2RD1-UK/R1
HX-KB2BL1-FR/R1	HX-KB2BR1-FR/R1	HX-KB2RD1-FR/R1
HX-KB2BL1-DE/R1	HX-KB2BR1-DE/R1	HX-KB2RD1-DE/R1
HX-KB2BL1-NO/R1	HX-KB2BR1-NO/R1	HX-KB2RD1-NO/R1
HX-KB2BL1-RU/R1	HX-KB2BR1-RU/R1	HX-KB2RD1-RU/R1
HX-KB2BL1-LA/R2	HX-KB2BR1-LA/R2	HX-KB2RD1-LA/R2
HX-KB2BL1-US/R1	HX-KB2BR1-US/R1	HX-KB2RD1-US/R1
HX-KB2BL1-US/R2	HX-KB2BR1-US/R2	HX-KB2RD1-US/R2

**Conteúdo da caixa:**

- Teclado Mecânico de Gaming HyperX Alloy Elite
- 8x Tampas de tecla para gaming
- Removedor de tampas de tecla
- Apoio para os pulsos





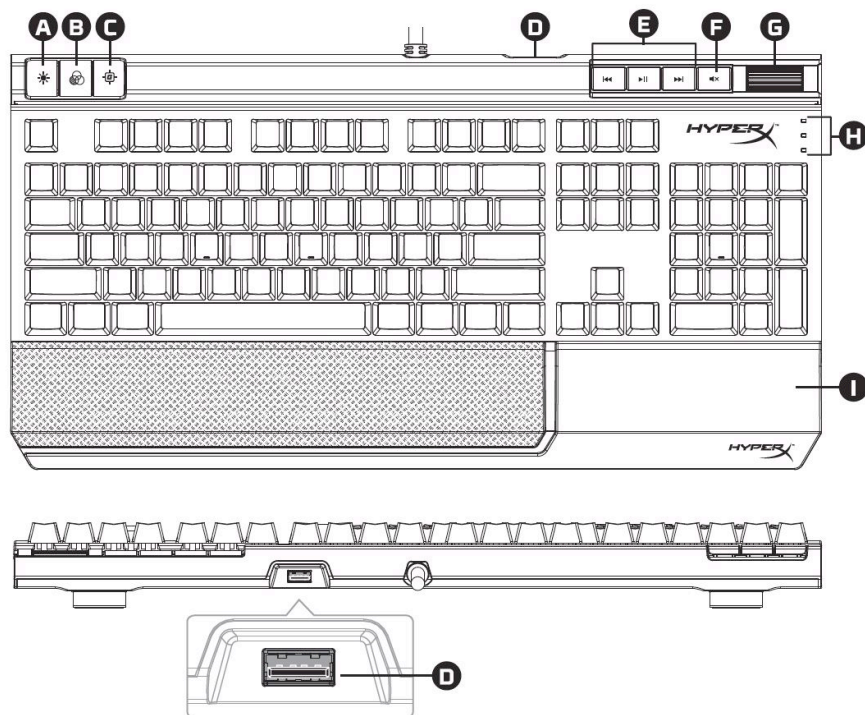

Visão geral do teclado:



A- Botão de controlo do brilho 

B- Botão de controlo do modo de LED 

C- Botão de modo de jogo 

D- Porta USB traseira (USB 2.0 pass-through) 

E- Botões de controlo de multimédia 

F- Botão para silenciar o volume 

G- Roda de controlo do volume 

H- Indicadores de modo de jogo / bloqueio de números / bloqueio de maiúsculas 

I- Apoio para os pulsos amovível





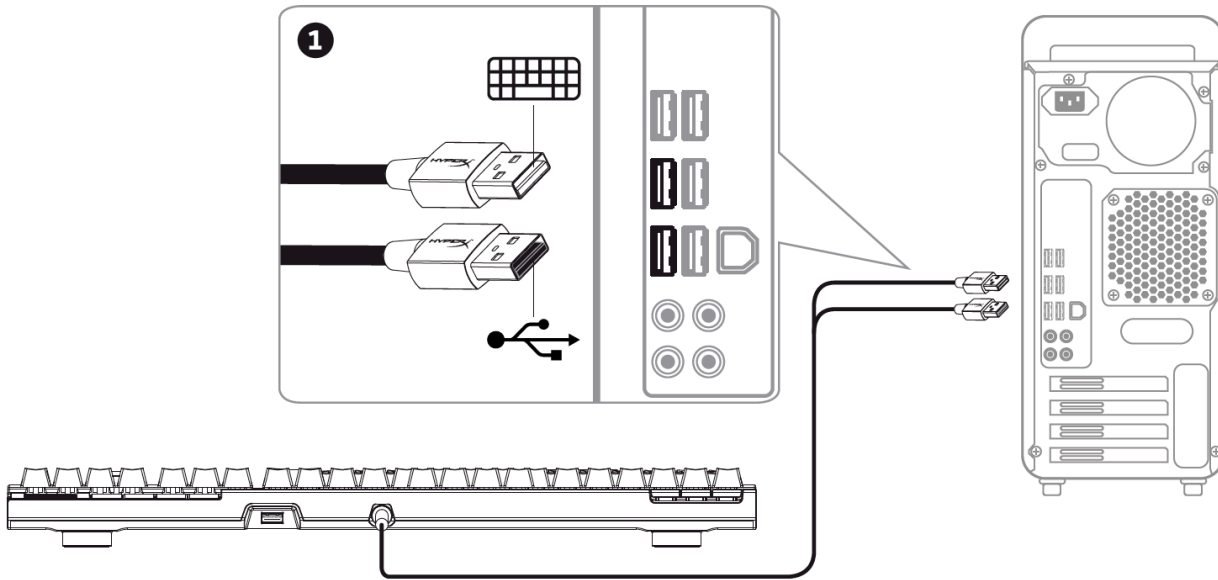





Instalação do teclado:

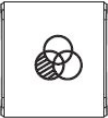

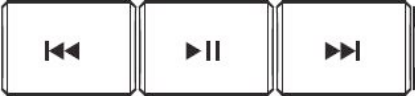
1- Liga ambos os conectores USB ao computador.

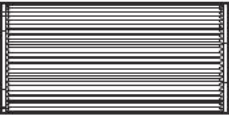

Teclas de função:

Teclas de função	Funcionalidade secundária
	<p>Alterar o brilho da retroiluminação LED. Existem 4 níveis de brilho: Desligado, baixo, médio e elevado.</p>
	<p>Mudar entre os modos de retroiluminação LED.</p>
	<p>Ativar o modo de jogo  para desativar a tecla Windows e evitar uma interrupção acidental durante o jogo. Quando o modo de jogo está ativado, o indicador está aceso.</p>
	<p>Reproduzir/Pausa , recuar  ou avançar  durante a audição de música ou visualização de vídeos.</p>
	<p>Silenciar  o áudio do computador.</p>
	<p>Aumentar ou diminuir o volume do áudio do computador.</p>



Modos de retroiluminação LED:

Existem seis modos de retroiluminação LED: ► Sólido (predefinido) ► Respiração ► Gatilho ► Explosão ► Onda ► Personalizado.



Sólido: Iluminação constante (predefinição).



Respiração: Intermitência rítmica lenta que imita a respiração.



Gatilho: Teclas específicas acendem-se ao serem premidas e apagam-se lentamente após um segundo.



Explosão: Teclas específicas irradiam um efeito de luz ao serem premidas.



Onda: As teclas acendem-se da esquerda para a direita num padrão de onda.



Personalizado: Podes escolher as teclas que pretendes que se acendam.

Segue estes passos para personalizares:

- 1- Muda o modo de retroiluminação para Personalizado.

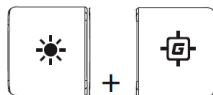

- 2- Prime continuamente até a retroiluminação se apagar.

- 3- Prime a tecla ou teclas que pretendes ter com a retroiluminação ativada.



- 4- Quando terminares, prime novamente para guardares o teu perfil de retroiluminação.



Reposição de fábrica do teclado:

Se tiveres algum problema com o teclado, podes efetuar uma reposição de fábrica. Isto significa perder o perfil de LED personalizado.

Teclas de função	Funcionalidade secundária
	Prime as três teclas simultaneamente até a retroiluminação LED do teclado piscar duas vezes.



HyperX Alloy Elite – mechaniczna klawiatura dla graczy



Numery katalogowe		
Cherry® MX Blue	Cherry® MX Brown	Cherry® MX Red
HX-KB2BL1-UK/R1	HX-KB2BR1-UK/R1	HX-KB2RD1-UK/R1
HX-KB2BL1-FR/R1	HX-KB2BR1-FR/R1	HX-KB2RD1-FR/R1
HX-KB2BL1-DE/R1	HX-KB2BR1-DE/R1	HX-KB2RD1-DE/R1
HX-KB2BL1-NO/R1	HX-KB2BR1-NO/R1	HX-KB2RD1-NO/R1
HX-KB2BL1-RU/R1	HX-KB2BR1-RU/R1	HX-KB2RD1-RU/R1
HX-KB2BL1-LA/R2	HX-KB2BR1-LA/R2	HX-KB2RD1-LA/R2
HX-KB2BL1-US/R1	HX-KB2BR1-US/R1	HX-KB2RD1-US/R1
HX-KB2BL1-US/R2	HX-KB2BR1-US/R2	HX-KB2RD1-US/R2

**Zawartość zestawu:**







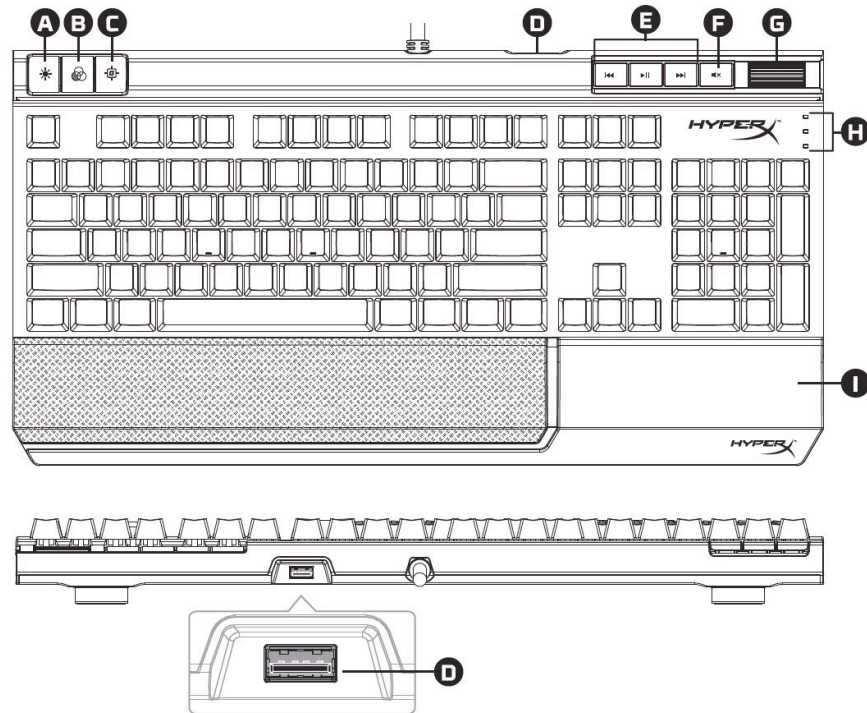

- HyperX Alloy Elite – mechaniczna klawiatura dla graczy
- 8 gamingowych nakładek na klawisze
- Przynrząd do zdejmowania nakładek
- Podpórka pod nadgarstki





Prezentacja klawiatury:

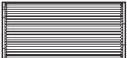



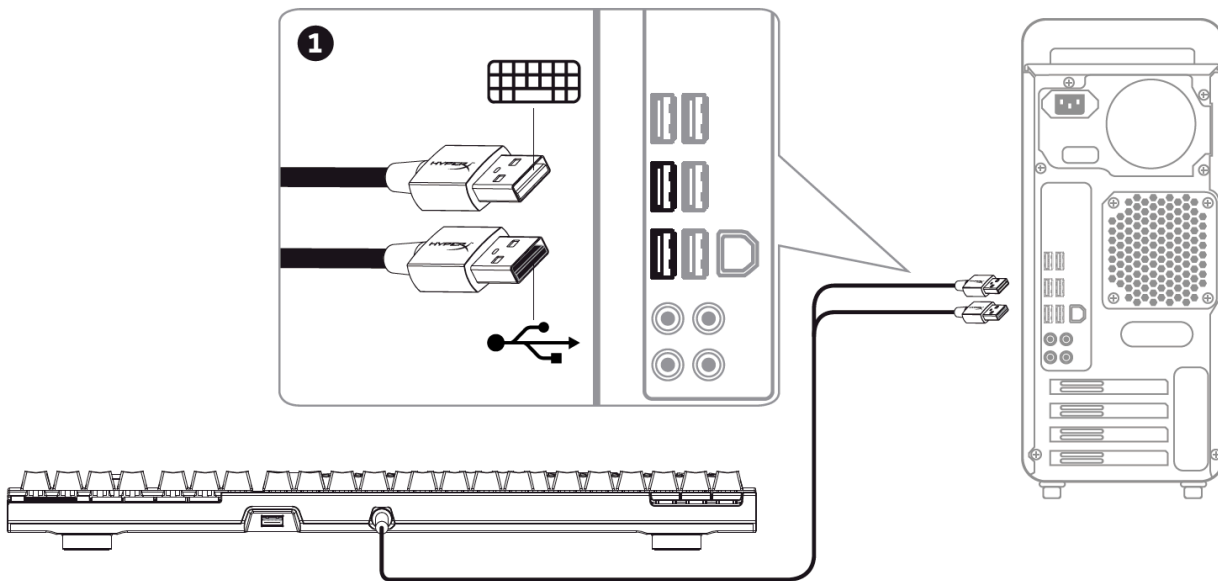



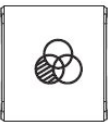

- A- Przycisk sterowania jasnością 
- B- Przycisk sterowania trybem podświetlenia LED 
- C- Przycisk trybu gry 
- D- Tylny port USB (złącze przelotowe USB 2.0) 
- E- Przyciski do sterowania multimediami 
- F- Przycisk wyciszenia 
- G- Pokrętko głośności 
- H- Wskaźniki trybu gry / Num Lock / Caps Lock 
- I- Odłączana podpórka pod nadgarstki

**Instalacja klawiatury:**

1- Podłączyć oba wtyki USB do komputera.

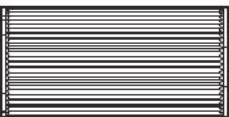

Klawisze funkcyjne:

Klawisze funkcyjne	Funkcja dodatkowa
	<p>Zmiana jasności podświetlenia LED. Dostępne są cztery poziomy jasności podświetlenia: wyłączone, niski, średni i wysoki.</p>
	<p>Przełączanie trybu podświetlenia LED.</p>
	<p>Włącz tryb gry , aby wyłączyć klawisz Windows i zapobiec niezamierzonemu zakłóceniu gry. O włączeniu trybu gry informuje świecący wskaźnik.</p>
	<p>Odtwarzanie / pauza , przewijanie do tyłu  i przewijanie do przodu  to przyciski działające podczas odtwarzania muzyki lub filmu.</p>
	<p>Wyciszenie  dźwięków z komputera.</p>
	<p>Zwiększanie lub zmniejszanie głośności dźwięków z komputera.</p>



Tryby podświetlenia LED:

Jest sześć trybów podświetlenia LED: ▶ Stałe (domyślnie) ▶ Oddech ▶ Spust ▶ Eksplozja ▶ Fala ▶ Użytkownika.



Stałe: ciągłe podświetlenie (ustawienie domyślne).



Oddech: powolne, rytmiczne pulsowanie naśladujące oddech.



Spust: podświetlanie tylko naciskanych klawiszy i powolne wygaszanie po upływie sekundy.



Eksplozja: efekt podświetlenia rozchodzącego się od naciskanych klawiszy.



Fala: podświetlanie klawiszy od lewej do prawej w formie fali.



Użytkownika: możliwość wyboru podświetlanych klawiszy.

Aby ustawić podświetlane klawisze, wykonaj następujące czynności:

- 1- Ustaw tryb podświetlenia Użytkownika.

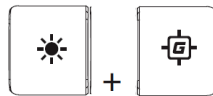

- 2- Naciśnij i przytrzymaj [sun icon] + [square icon] do chwili wyłączenia podświetlenia.

- 3- Naciśnij klawisz lub klawisze, które mają być podświetlone.

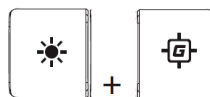

- 4- Po skończeniu ponownie naciśnij i przytrzymaj [sun icon] + [square icon], aby zapisać profil podświetlenia.



Przywracanie ustawień fabrycznych klawiatury:

W razie jakichkolwiek problemów w działaniu klawiatury można przywrócić jej ustawienia fabryczne. Spowoduje to usunięcie ustawień podświetlenia LED skonfigurowanych przez użytkownika.

Klawisze funkcyjne	Funkcja dodatkowa
	<p>Przytrzymaj wszystkie trzy klawisze równocześnie, aż podświetlenie LED klawiatury zabłyśnie dwukrotnie.</p>



Механическая геймерская клавиатура HyperX Alloy Elite



Номера по каталогу		
Cherry® MX Blue	Cherry® MX Brown	Cherry® MX Red
HX-KB2BL1-UK/R1	HX-KB2BR1-UK/R1	HX-KB2RD1-UK/R1
HX-KB2BL1-FR/R1	HX-KB2BR1-FR/R1	HX-KB2RD1-FR/R1
HX-KB2BL1-DE/R1	HX-KB2BR1-DE/R1	HX-KB2RD1-DE/R1
HX-KB2BL1-NO/R1	HX-KB2BR1-NO/R1	HX-KB2RD1-NO/R1
HX-KB2BL1-RU/R1	HX-KB2BR1-RU/R1	HX-KB2RD1-RU/R1
HX-KB2BL1-LA/R2	HX-KB2BR1-LA/R2	HX-KB2RD1-LA/R2
HX-KB2BL1-US/R1	HX-KB2BR1-US/R1	HX-KB2RD1-US/R1
HX-KB2BL1-US/R2	HX-KB2BR1-US/R2	HX-KB2RD1-US/R2

**Комплект поставки:**







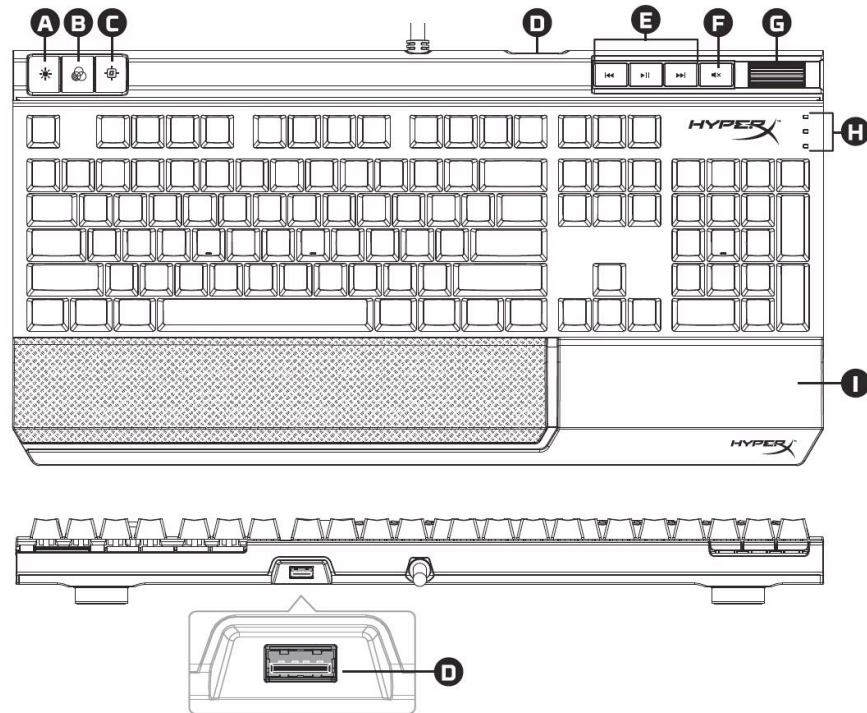

- Механическая геймерская клавиатура HyperX Alloy Elite
- 8 геймерских колпачков клавиш
- Съёмник колпачков клавиш
- Опора для запястья





Обзор клавиатуры:

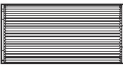

- A- Кнопка регулировки яркости 
- B- Кнопка светодиодного режима 
- C- Кнопка игрового режима 
- D- Задний порт USB (проходной порт USB 2.0) 
- E- Кнопки управления мультимедиа 
- F- Кнопка отключения звука 
- G- Колесико регулировки громкости 
- H- Индикаторы игрового режима/Num Lock/Caps Lock 
- I- Съёмная опора для запястья



Подключение клавиатуры:

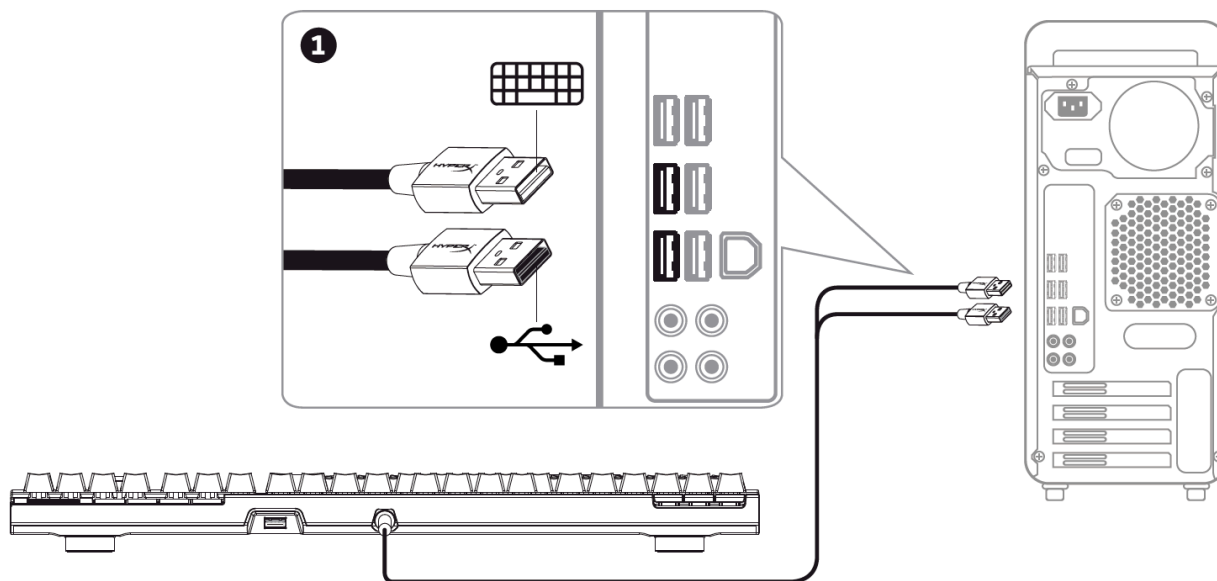

1- Подсоедините оба разъема USB к компьютеру.



Функциональные клавиши:

Функциональные клавиши	Вспомогательная функция
	<p>Изменение яркости светодиодной подсветки. Имеется 4 уровня яркости: ВЫКЛ, низкий, средний и высокий.</p>
	<p>Переключение между режимами светодиодной подсветки.</p>
	<p>Включите Игровой режим  для отключения клавиши Windows и предотвращения случайного прерывания игры. При включении игрового режима загорается индикатор.</p>
	<p>Воспроизведение/пауза ► , прокрутка назад ◀◀ или прокрутка вперед ▶▶ при прослушивании музыки или просмотре видео.</p>
	<p>Отключение  звука.</p>
	<p>Увеличение или уменьшение громкости звука.</p>



Режимы светодиодной подсветки:

Имеется шесть режимов светодиодной подсветки: ► Постоянный (по умолчанию) ► Прерывистый ► Срабатываемый ► Вспышка ► Волнообразный ► Пользовательский.



1- Постоянный: Постоянное свечение (настройка по умолчанию).



2- Прерывистый: Медленное ритмичное мигание, имитирующее дыхание.



3- Срабатываемый: Отдельные клавиши загораются при нажатии и медленно потухают через одну секунду.



4- Вспышка: Световой эффект при нажатии отдельных клавиш.



5- Волнообразный: Клавиши подсвечиваются слева направо в виде волны.





6- Пользовательский: Вы можете выбрать, для каких клавиш будет включаться подсветка.

Для настройки пользовательского режима выполните следующие действия:

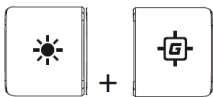

- 1- Переключите режим подсветки в Пользовательский режим.

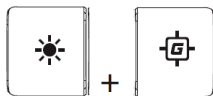

- 2- Удерживайте  + , пока подсветка не отключится.

- 3- Нажмите одну или несколько клавиш, для которых вы хотите включить подсветку.



- 4- В конце нажмите  +  снова, чтобы сохранить свой индивидуальный профиль подсветки.

**Сброс к заводским настройкам:**

При возникновении каких-либо проблем с клавиатурой вы можете вернуться к заводским настройкам. При этом вы потеряете свой индивидуальный светодиодный профиль.

Функциональные клавиши	Вспомогательная функция
	Нажмите все три клавиши одновременно, пока светодиодная подсветка не мигнет дважды.



HyperX Alloy Elite Mekanik Oyun Klavyesi



Parça Numaraları		
Cherry® MX Blue	Cherry® MX Brown	Cherry® MX Red
HX-KB2BL1-UK/R1	HX-KB2BR1-UK/R1	HX-KB2RD1-UK/R1
HX-KB2BL1-FR/R1	HX-KB2BR1-FR/R1	HX-KB2RD1-FR/R1
HX-KB2BL1-DE/R1	HX-KB2BR1-DE/R1	HX-KB2RD1-DE/R1
HX-KB2BL1-NO/R1	HX-KB2BR1-NO/R1	HX-KB2RD1-NO/R1
HX-KB2BL1-RU/R1	HX-KB2BR1-RU/R1	HX-KB2RD1-RU/R1
HX-KB2BL1-LA/R2	HX-KB2BR1-LA/R2	HX-KB2RD1-LA/R2
HX-KB2BL1-US/R1	HX-KB2BR1-US/R1	HX-KB2RD1-US/R1
HX-KB2BL1-US/R2	HX-KB2BR1-US/R2	HX-KB2RD1-US/R2

**Paketin iindekiler:**

- HyperX Alloy Elite Mekanik Oyun Klavyesi
- 8 Oyun tuşu kapađı
- Tuş kapađı ektirme aleti
- Bilek desteđi





Klavyeye Genel Bakış:

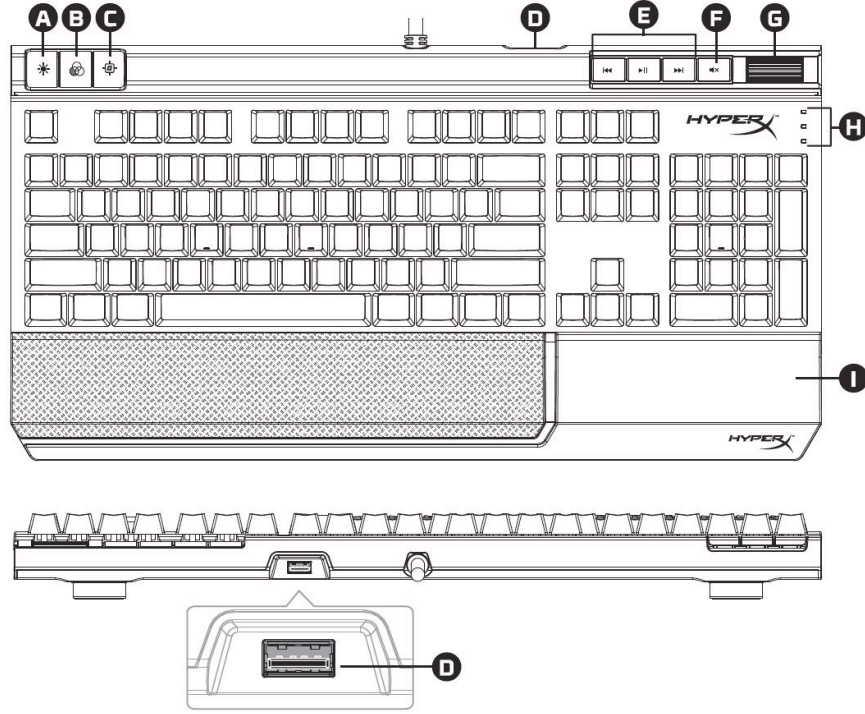

A- Parlaklık kontrol düğmesi



B- LED modu kontrol düğmesi



C- Oyun Modu düğmesi



D- Arka USB bağlantı noktası (Doğrudan geçişli USB 2.0)



E- Medya kontrol düğmeleri



F- Sessize alma düğmesi



G- Ses seviyesi kontrol tekerleği

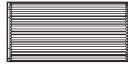

H- Oyun Modu / Num Lock / Caps Lock göstergeleri

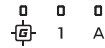



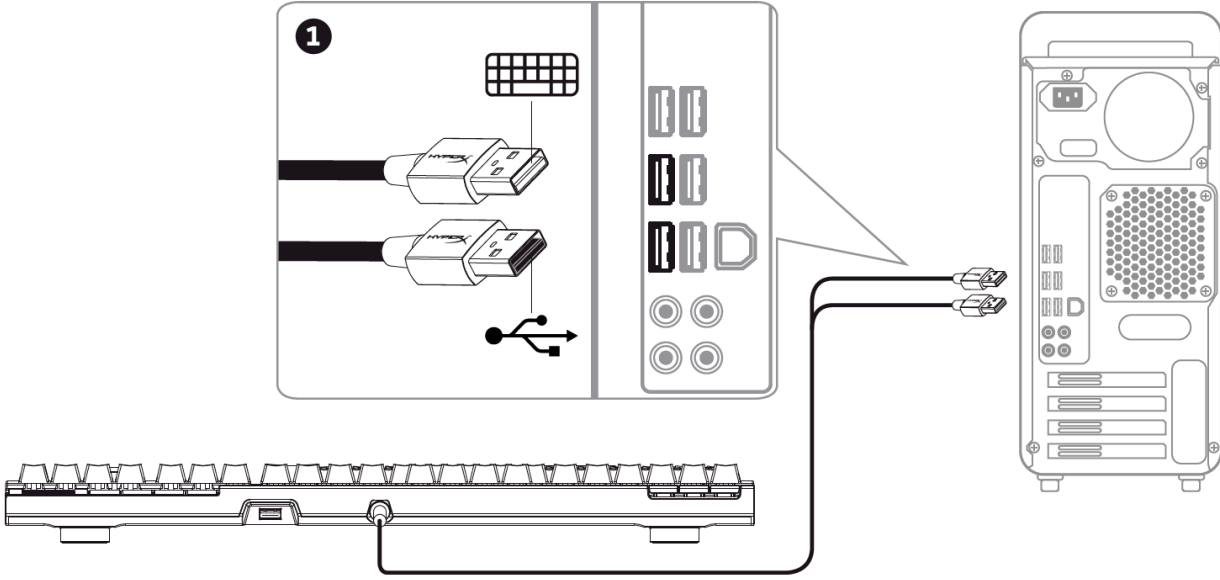



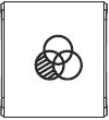

I- Çıkarılabilir bilek desteği

**Klavye Kurulumu:**

1- Her iki USB konnektörünü bilgisayara bağlayın.

**Fonksiyon Tuşları:**

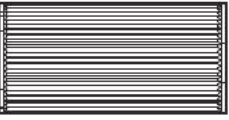
Fonksiyon Tuşları	İkincil Özellik
	LED arka ışık parlaklığını değiştirin. 4 parlaklık seviyesi bulunur: KAPALI (OFF), düşük, orta ve yüksek.
	LED arka ışık modları arasında geçiş yapın.
	Windows tuşunu devre dışı bırakmak ve oyunların yanlışlıkla kesintiye uğramasını önlemek için Oyun Modunu  etkinleştirin. Oyun Modu etkinleştirildiğinde, göstere yanacaktır.
	Müzik dinlerken veya video izlerken oynatma/duraklatma  , geri alma  veya ileri alma  gibi işlevleri gerçekleştirin.
	 Bilgisayarı sessize alın.
	Bilgisayarın ses seviyesini artırın veya azaltın.



LED arka ışık modları:

Altı farklı LED arka ışık modu bulunur: ► Sabit (varsayılan) ► Nefes ► Kışkırtıcı ► Patlama ► Dalga ► Özel.



Sabit: Sabit ışık (varsayılan ayar).



Nefes: Nefes alma şeklinde yavaşça uyumlu yanıp sönme.



Kışkırtıcı: Her tuş, basıldığında yanacak ve bir saniye sonra yavaşça sönecektir.



Patlama: Her bir tuşa basıldığında bir ışık efekti yayılacaktır.



Dalga: Tuşlar soldan sağa doğru dalga şeklinde yanacaktır.



Özel: Yanmasını istediğiniz tuşları seçebilirsiniz.

Özelleştirmek için bu adımları izleyin:

1- Arka ışık modunu Özel olarak değiştirin.

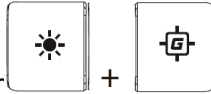

2- Arka ışık sönene kadar + tuşunu basılı tutun.

3- Arka ışığının yanmasını istediğiniz tuş veya tuşlara basın.

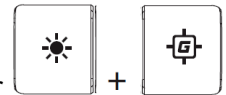

4- İşlem tamamlandıktan sonra, özel arka ışık profilinizi kaydetmek için tekrar + tuşuna basın.

**Klavye fabrika ayarlarına sıfırlama:**

Klavye ile ilgili bir sorun yaşıyorsanız, fabrika ayarlarına sıfırlama işlemi gerçekleştirebilirsiniz. Bu işlem, özel LED profilinizin silinmesine neden olur.

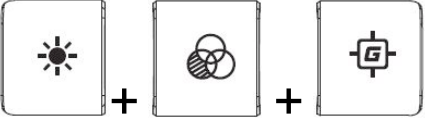
Fonksiyon Tuşları	İkincil Özellik
	Klavye LED arka ışığı iki kez yanıp sönene kadar aynı anda tüm üç tuşa da basın.



HyperX Alloy Elite メカニカルゲーミングキーボード



製品番号		
Cherry® MX ブルー	Cherry® MX ブラウン	Cherry® MX レッド
HX-KB2BL1-UK/R1	HX-KB2BR1-UK/R1	HX-KB2RD1-UK/R1
HX-KB2BL1-FR/R1	HX-KB2BR1-FR/R1	HX-KB2RD1-FR/R1
HX-KB2BL1-DE/R1	HX-KB2BR1-DE/R1	HX-KB2RD1-DE/R1
HX-KB2BL1-NO/R1	HX-KB2BR1-NO/R1	HX-KB2RD1-NO/R1
HX-KB2BL1-RU/R1	HX-KB2BR1-RU/R1	HX-KB2RD1-RU/R1
HX-KB2BL1-LA/R2	HX-KB2BR1-LA/R2	HX-KB2RD1-LA/R2
HX-KB2BL1-US/R1	HX-KB2BR1-US/R1	HX-KB2RD1-US/R1
HX-KB2BL1-US/R2	HX-KB2BR1-US/R2	HX-KB2RD1-US/R2

**製品内容:**







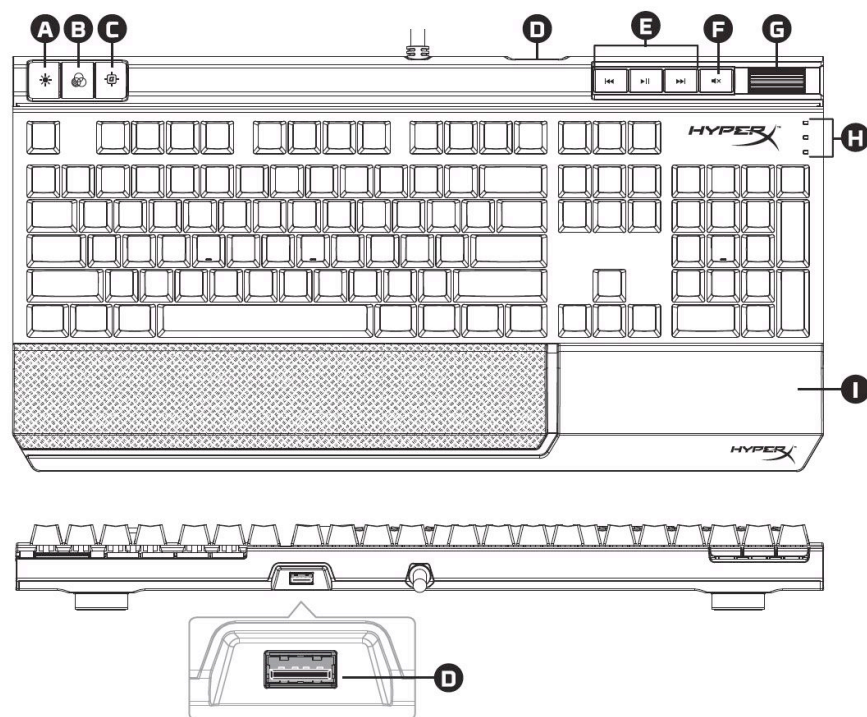

- HyperX Alloy Elite メカニカルゲーミングキーボード
- ゲーミングキートップ x 8
- キートップ引き抜き工具
- リストレスト





キーボードの概要:

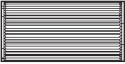

- A- 明度コントロールボタン 
- B- LED モードコントロールボタン 
- C- ゲームモードボタン 
- D- 背面の USB ポート (USB 2.0 パススルー) 
- E- メディアコントロールボタン 
- F- 音量ミュートボタン 
- G- 音量コントロールホイール 
- H- ゲームモード / Num Lock / Caps Lock のインジケータ 
- I- 取り外し可能なリストレスト





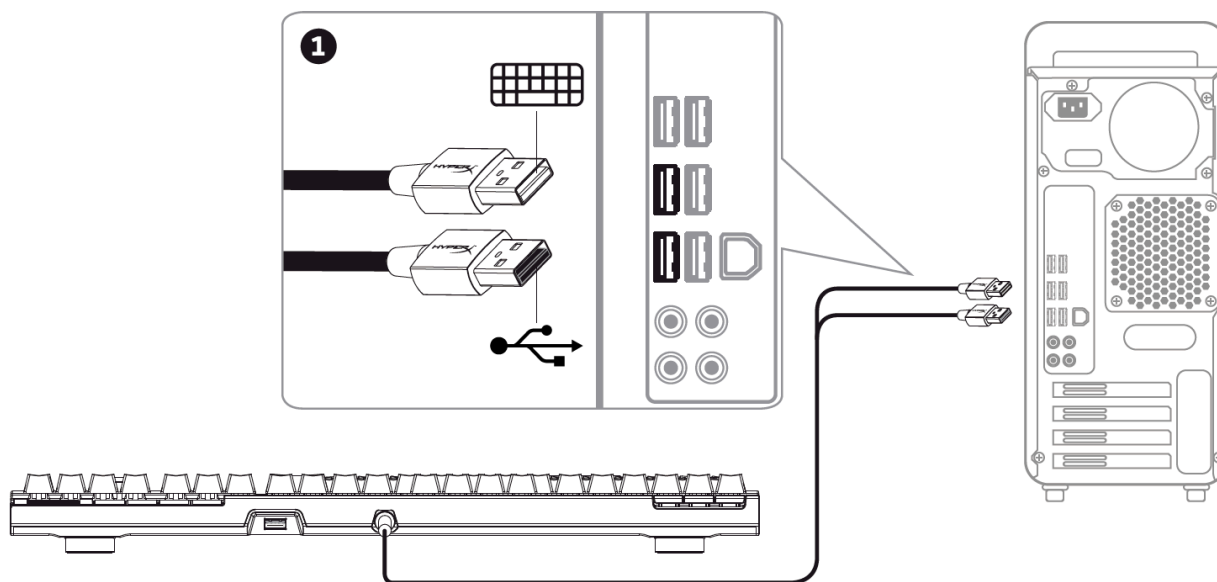



キーボードの取り付け:



1- 2つのUSBコネクターをコンピューターに接続します。

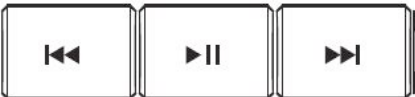

ファンクションキー:

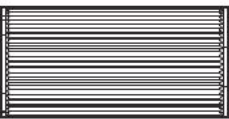
ファンクションキー	セカンダリ機能
	<p>LED バックライトの明るさを変えます。明るさのレベルは、オフ、低、中、高の 4 つがあります。</p>
	<p>LED バックライトモードを切り替えます。</p>
	<p>ゲームモード  を有効にします。Windows キーを無効にし、ゲームが誤って中断されないようにします。ゲームモードが有効な間は、インジケータが点灯します。</p>
	<p>再生/一時停止▶ 、前のトラック◀◀、次のトラック▶▶の各機能を音楽または動画プレーヤーにて使用できます。</p>
	<p>コンピューターオーディオをミュート◀×します。</p>
	<p>コンピューターオーディオの音量を上げ下げします。</p>



LED バックライトモード:

LED バックライトモードには、▶ ソリッド(デフォルト) ▶ ブリージング ▶ トリガー ▶ エクスプロージョン ▶ ウェーブ ▶ カスタムの6つがあります。



① ソリッド:常時点灯(デフォルト設定)。



② ブリージング:呼吸するようにゆっくりとリズムカルに点滅します。



③ トリガー:押されたキーが光り、1秒後にゆっくりと消えます。



④ エクスプロージョン:押されたキーを中心にして、点灯キーが放射状に広がります。





⑤ ウェーブ:波のように、左から右にキーが光ります。





⑥ カスタム:光るキーを選ぶことができます。

カスタマイズの手順は、次のとおりです。

1- バックライトモードをカスタムに切り替えます。

2- バックライトがオフになるまで  +  を押し続けます。

3- バックライトをオンにしたいキー(複数可)を押します。

4- 終了したら、もう一度  +  を押して、カスタムバックライトプロファイルを保存します。



キーボードを工場出荷状態にリセットする:

キーボードに問題が生じた場合、工場出荷状態に戻すことができます。これにより、カスタム LED プロファイルは失われます。

ファンクションキー	セカンダリ機能
	<p>キーボードの LED バックライトが 2 回点滅するまで、3 つのキーをすべて同時に押してください。</p>



HyperX Alloy Elite

기계식 게임용 키보드



부품 번호		
Cherry® MX Blue	Cherry® MX 브라운	Cherry® MX 레드
HX-KB2BL1-UK/R1	HX-KB2BR1-UK/R1	HX-KB2RD1-UK/R1
HX-KB2BL1-FR/R1	HX-KB2BR1-FR/R1	HX-KB2RD1-FR/R1
HX-KB2BL1-DE/R1	HX-KB2BR1-DE/R1	HX-KB2RD1-DE/R1
HX-KB2BL1-NO/R1	HX-KB2BR1-NO/R1	HX-KB2RD1-NO/R1
HX-KB2BL1-RU/R1	HX-KB2BR1-RU/R1	HX-KB2RD1-RU/R1
HX-KB2BL1-LA/R2	HX-KB2BR1-LA/R2	HX-KB2RD1-LA/R2
HX-KB2BL1-US/R1	HX-KB2BR1-US/R1	HX-KB2RD1-US/R1
HX-KB2BL1-US/R2	HX-KB2BR1-US/R2	HX-KB2RD1-US/R2



구성품:







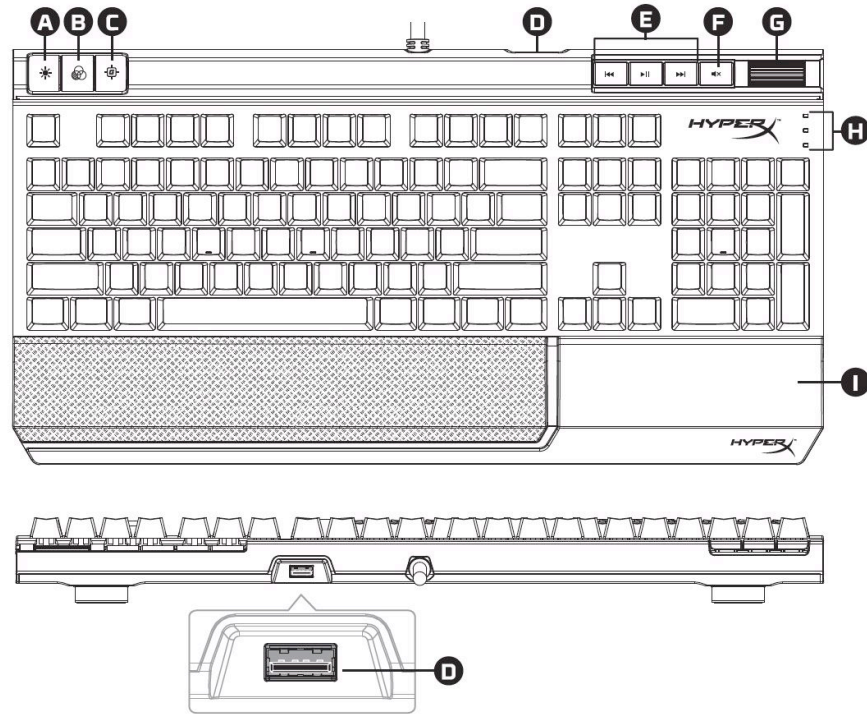

- HyperX Alloy Elite 기계식 게임용 키보드
- 게임용 키 캡(8 개)
- 키 캡 풀러
- 손목지지대



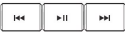

키보드 개요:

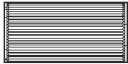

- A- 밝기 제어 버튼 
- B- LED 모드 제어 버튼 
- C- 게임 모드 버튼 
- D- 백 USB 포트(USB 2.0 패스스루) 
- E- 미디어 제어 버튼 
- F- 음소거 버튼 
- G- 볼륨 제어 휠 
- H- 게임 모드 / Num Lock / Caps Lock 표시등 
- I- 분리형 손목지지대





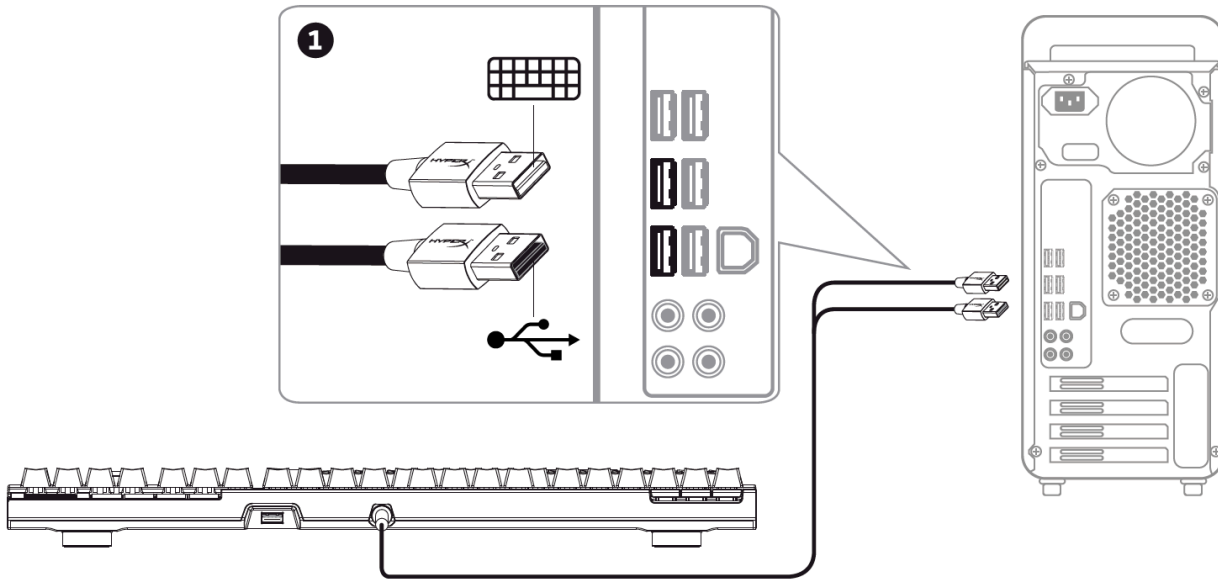





키보드 설치:

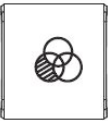

1- 컴퓨터에 USB 커넥터들을 모두 연결합니다.

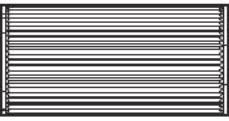

기능 키:

기능 키	제 2 기능
	<p>LED 백라이트 밝기 변경. 다음과 같은 4 개 수준의 밝기가 있습니다. 끄기, 낮음, 중간, 높음.</p>
	<p>LED 백라이트 모드 변경</p>
	<p>게임 모드에서는  게임하는 동안 Windows 키가 비활성화되어 실수로 게임이 중단되는 것을 방지합니다. 게임 모드가 활성화된 경우 표시등에 조명이 들어옵니다.</p>
	<p>음악을 듣거나 비디오를 보는 동안 재생/일시 정지 , 뒤로 건너뛰기  또는 앞으로 건너뛰기 .</p>
	<p>컴퓨터 오디오 음소거 .</p>
	<p>컴퓨터 오디오 볼륨 키우기 또는 줄이기.</p>



LED 백라이트 모드:

6 개의 LED 백라이트 모드가 있습니다. ▶ 단색(기본) ▶ 브레싱 ▶ 트리거 ▶ 폭발 ▶ 웨이브 ▶ 사용자 지정.

① 단색: 일정하게 빛남(기본 설정).

② 브레싱: 숨쉬는 것처럼 느린 리듬으로 깜박거림.

③ 트리거: 개별 키들이 누를 때마다 빛나고 1 초 후 서서히 희미해짐.



④ 폭발: 누를 때 마다 개별 키에서 빛 효과가 발생함.

⑤ 웨이브: 키가 왼쪽에서 오른쪽으로 웨이브 모양으로 빛남.



⑥ 사용자 지정: 사용자가 빛나길 원하는 키를 선택할 수 있음.

이 단계에 따라 사용자 지정하십시오.

- 1- 백라이트 모드를 사용자 지정으로 전환하십시오.

2- 백라이트가 꺼질 때까지  +  를 누르고 계속하십시오.

- 3- 백라이트 모드를 실행할 키 또는 복수의 키를 누르십시오.

4- 완료되면,  +  를 다시 눌러 사용자 지정 백라이트 프로필을 저장하십시오.



키보드 공장 기본값 재설정:

키보드에 문제가 있는 경우 데이터 초기화를 실행할 수 있습니다. 이를 실행하면서 사용자 지정 LED 프로필이 손실될 수 있습니다.

기능 키	제 2 기능
	<p>키보드 LED 백라이트가 두 번 깜박일 때까지 세 키 모두를 동시에 누르십시오.</p>



แป้นพิมพ์เล่นเกม HyperX Alloy Elite



เลขชิ้นส่วน		
Cherry® MX Blue	Cherry® MX Brown	Cherry® MX Red
HX-KB2BL1-UK/R1	HX-KB2BR1-UK/R1	HX-KB2RD1-UK/R1
HX-KB2BL1-FR/R1	HX-KB2BR1-FR/R1	HX-KB2RD1-FR/R1
HX-KB2BL1-DE/R1	HX-KB2BR1-DE/R1	HX-KB2RD1-DE/R1
HX-KB2BL1-NO/R1	HX-KB2BR1-NO/R1	HX-KB2RD1-NO/R1
HX-KB2BL1-RU/R1	HX-KB2BR1-RU/R1	HX-KB2RD1-RU/R1
HX-KB2BL1-LA/R2	HX-KB2BR1-LA/R2	HX-KB2RD1-LA/R2
HX-KB2BL1-US/R1	HX-KB2BR1-US/R1	HX-KB2RD1-US/R1
HX-KB2BL1-US/R2	HX-KB2BR1-US/R2	HX-KB2RD1-US/R2

**สิ่งที่จัดมาให้:**







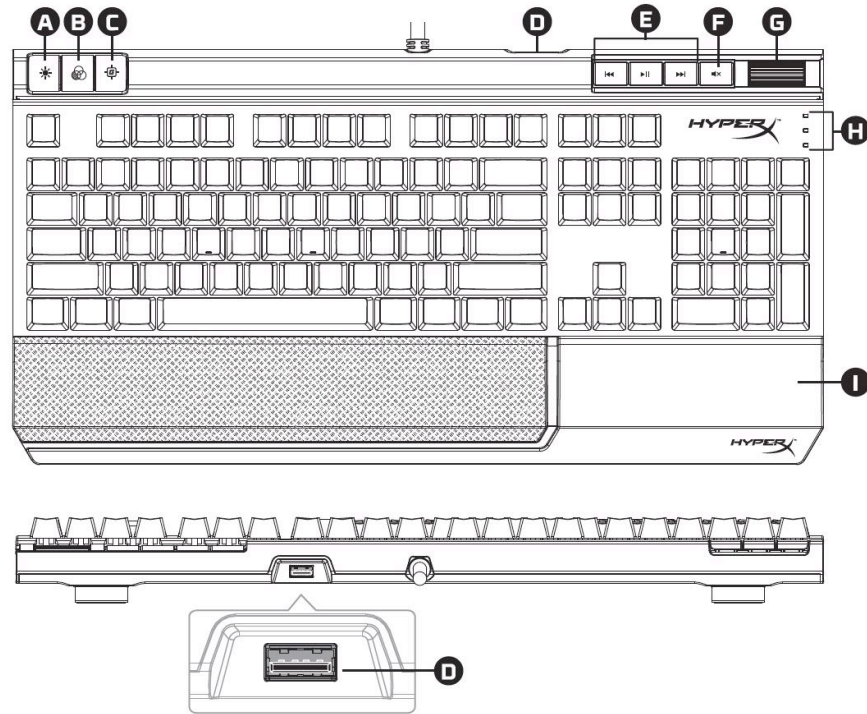

- แป้นพิมพ์เล่นเกม HyperX Alloy Elite
- แป้นครอบปุ่มสำหรับเล่นเกม 8x
- ตัวตั้งแป้นครอบ
- ที่วางข้อมือ





เบื้องต้นเกี่ยวกับแป้นพิมพ์:



- A- ปุ่มปรับความสว่าง 
- B- ปุ่มปรับโหมด LED 
- C- ปุ่มโหมดเกม 
- D- พอร์ต USB ด้านหลัง (USB 2.0 pass-through) 
- E- ปุ่มควบคุมมีเดีย 
- F- ปุ่มปิดเสียง 
- G- แป้นปรับระดับเสียง 
- H- ไฟสถานะโหมดเกม / Num Lock / Caps Lock 
- I- ที่วางข้อมือแบบถอดแยกได้





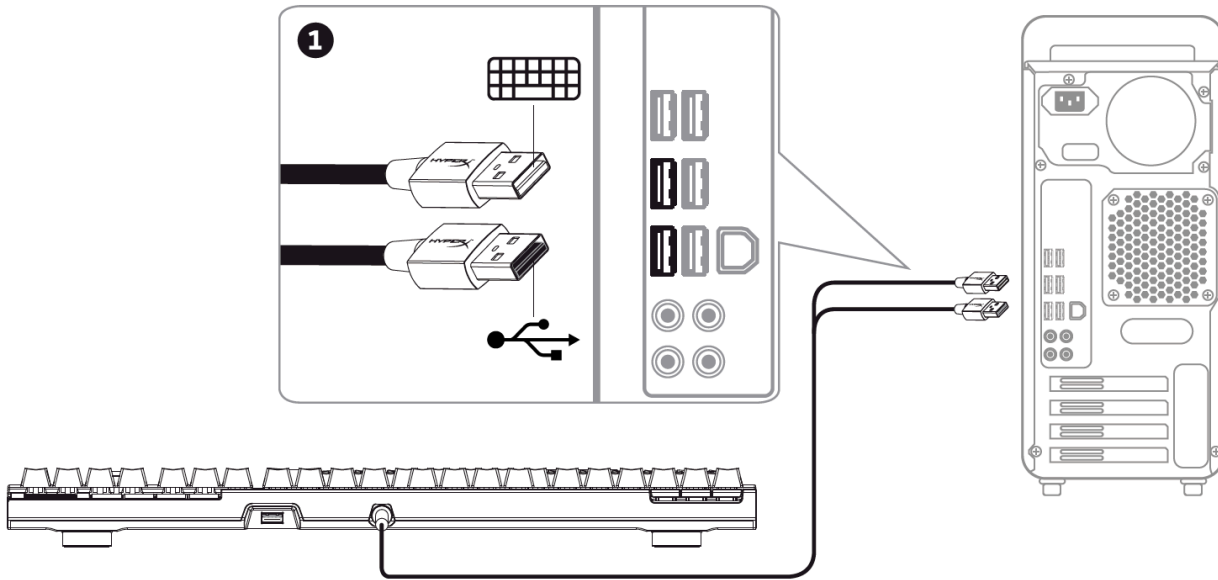

การติดตั้งแป้นพิมพ์:



- 1- ต่อหัวต่อ USB ทั้งสองเข้ากับคอมพิวเตอร์

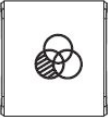

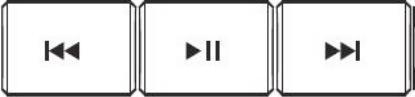
ปุ่มฟังก์ชัน

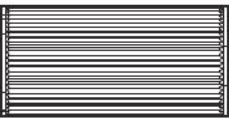
ปุ่มฟังก์ชัน	คุณสมบัติเด่นเพิ่มเติม
	ปรับความสว่าง LED พื้นหลัง ปรับความสว่างได้ 4 ระดับได้แก่ OFF, low, medium และ high
	สลับโหมด LED ไฟพื้นหลัง
	เปิดใช้ Game Mode เพื่อปิดใช้งานปุ่ม Windows และป้องกันการแทรกแซงระหว่างการเล่นเกมโดยไม่ได้ตั้งใจ หากเปิดใช้ Game Mode ไฟสถานะจะติดสว่าง
	เปิดเล่น/หยุดชั่วคราว ▶ กรอเดินทาง ◀◀ หรือย้อนกลับ ▶▶ ขณะรับฟังเพลงหรือชมวิดีโอ
	ปิดเสียง ◻× คอมพิวเตอร์
	เพิ่มหรือลดระดับเสียงคอมพิวเตอร์



โหมดไฟพื้นหลัง LED:

มีโหมด LED ไฟพื้นหลังหกโหมดได้แก่ ► Solid (ค่าเริ่มต้น) ► Breathing ► Trigger ► Explosion ► Wave ► Custom



1 Solid: ติดค้าง (ค่าเริ่มต้น)



2 Breathing: ไฟกะพริบเป็นจังหวะเหมือนการหายใจ



3 Trigger: แต่ละปุ่มจะติดสว่างเมื่อกดปุ่ม และค่อย ๆ หายไปหลังผ่านไปหนึ่งวินาที



4 Explosion: เอฟเฟกต์แสงที่เปลี่ยนแปลงแสงจากปุ่มที่กด





5 Wave: ปุ่มจะสว่างจากซ้ายไปขวาเป็นรูปคลื่น



6 Custom: คุณสามารถเลือกปุ่มที่ต้องการให้ติดสว่างได้

ทำตามขั้นตอนต่อไปนี่เพื่อกำหนดค่าเอง:

- 1- สลับโหมดไฟพื้นหลังเป็น Custom

2- กดค้างที่  +  จนกว่าไฟพื้นหลังจะดับลง

- 3- กดที่ปุ่มที่คุณต้องการให้ไฟพื้นหลังเปิดทำงาน

4- หลังจากเสร็จสิ้น กด  +  อีกครั้งเพื่อบันทึกโปรไฟล์ไฟพื้นหลังกำหนดเองของคุณ



รีเซ็ตแป้นพิมพ์เป็นค่าจากโรงงาน:

หากคุณพบปัญหาเกี่ยวกับแป้นพิมพ์ คุณสามารถรีเซ็ตคีย์บอร์ดจากโรงงานได้ โปรดไฟลด์ LED กำหนดเองของคุณจะหายไปหลังขั้นตอนนี้

ปุ่มฟังก์ชัน	คุณสมบัติเด่นเพิ่มเติม
	<p>กดทั้งสามปุ่มพร้อม ๆ กันจนกระทั่ง LED พื้นหลังแป้นพิมพ์กะพริบสองครั้ง</p>



Bàn phím chơi game cơ học HyperX Alloy Elite



Mã sản phẩm		
Cherry® MX Blue	Cherry® MX Brown	Cherry® MX Red
HX-KB2BL1-UK/R1	HX-KB2BR1-UK/R1	HX-KB2RD1-UK/R1
HX-KB2BL1-FR/R1	HX-KB2BR1-FR/R1	HX-KB2RD1-FR/R1
HX-KB2BL1-DE/R1	HX-KB2BR1-DE/R1	HX-KB2RD1-DE/R1
HX-KB2BL1-NO/R1	HX-KB2BR1-NO/R1	HX-KB2RD1-NO/R1
HX-KB2BL1-RU/R1	HX-KB2BR1-RU/R1	HX-KB2RD1-RU/R1
HX-KB2BL1-LA/R2	HX-KB2BR1-LA/R2	HX-KB2RD1-LA/R2
HX-KB2BL1-US/R1	HX-KB2BR1-US/R1	HX-KB2RD1-US/R1
HX-KB2BL1-US/R2	HX-KB2BR1-US/R2	HX-KB2RD1-US/R2

**Bộ sản phẩm gồm có:**

- Bàn phím chơi game cơ học HyperX Alloy Elite
- 8 chụp mũ phím game
- Dụng cụ tháo mũ phím
- Bộ kê cổ tay





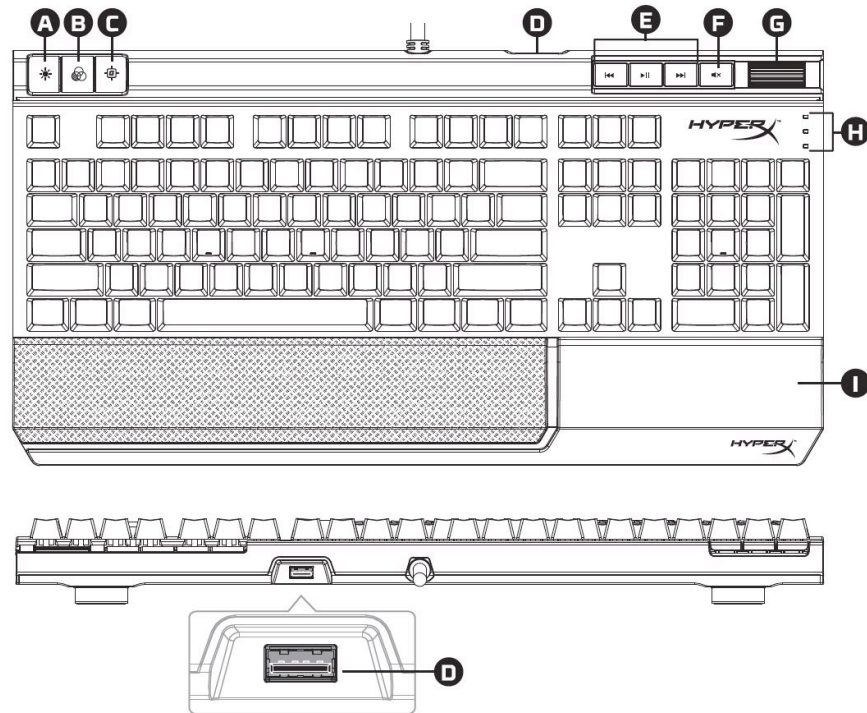

Tổng quan về bàn phím:





A- Nút điều chỉnh độ sáng 

B- Nút điều chỉnh chế độ LED 

C- Nút chế độ game 

D- Cổng USB phía sau (chuyển đổi qua cổng USB 2.0) 

E- Nút điều khiển media 

F- Nút điều chỉnh âm lượng và tắt 

G- Núm xoay điều chỉnh âm lượng 

H- Đèn chỉ báo chế độ game / Khóa chế độ nhập số / Khóa chế độ viết hoa 

I- Bộ kê cổ tay có thể tháo rời





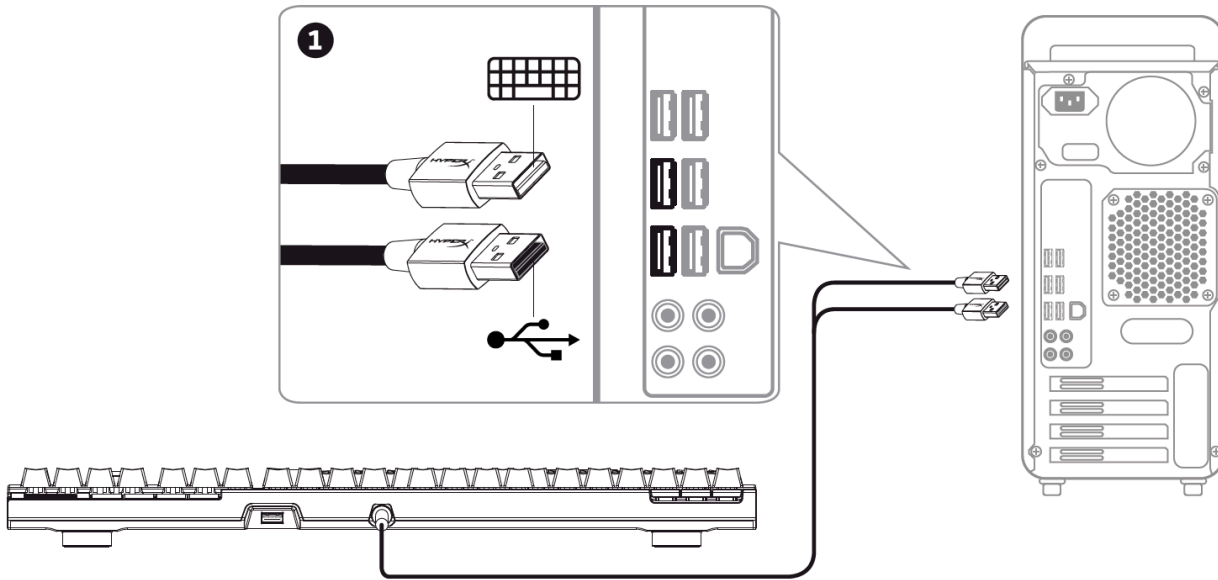

Lắp bàn phím:



1- Cắm cả hai đầu USB vào máy tính.

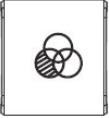

Các phím chức năng:

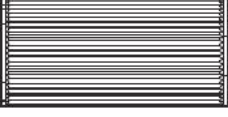
Các phím chức năng	Tính năng phụ
	Thay đổi độ sáng của đèn nền LED. Có 4 cấp độ sáng: TẮT, thấp, trung bình và cao.
	Chuyển chế độ đèn nền LED.
	Bật chế độ game để tắt phím Windows và tránh vô tình va chạm khi chơi game. Khi bật Chế độ game, đèn báo sẽ sáng.
	Mở/tạm dừng ► , tua lại ◀◀ hoặc tua đi ▶▶ khi nghe nhạc hoặc xem video.
	Tắt 🔊 tiếng máy tính.
	Tăng hoặc giảm âm lượng của âm thanh máy tính.



Chế độ đèn nền LED:

Có sáu chế độ đèn nền LED: ► Solid (Mặc định) ► Breathing (Nhịp thở) ► Trigger (Bật sáng) ► Explosion (Nổ) ► Wave (Sóng) ► Custom (Tùy chỉnh).



Solid (Ổn định): Ánh sáng ổn định (cài đặt mặc định).



Breathing (Nhịp thở): Nhấp nháy chậm theo nhịp thở.



Trigger (Bật sáng): Mỗi phím sẽ sáng lên khi nhấn rồi mờ dần sau một giây.



Explosion (Nổ): Ánh sáng sẽ phát ra từ mỗi phím khi nhấn.



Wave (Sóng): Các phím sẽ sáng theo chiều từ trái sang phải theo kiểu sóng.



Custom (Tùy chỉnh): Bạn có thể chọn các phím bạn muốn chiếu sáng.

Hãy làm theo các bước sau để tùy chỉnh:

1- Chuyển chế độ đèn nền sang Custom (Tùy chỉnh).

2- Giữ  +  cho tới khi đèn nền tắt.

3- Nhấn các phím mà bạn muốn BẬT chế độ chiếu sáng.

4- Khi hoàn tất, nhấn lại  +  để lưu cấu hình chiếu sáng tùy chỉnh.

**Đặt bàn phím về thiết lập ban đầu:**

Nếu gặp sự cố với bàn phím, bạn có thể đặt nó về thiết lập ban đầu. Bạn sẽ mất cấu hình LED tùy chỉnh khi làm vậy.

Các phím chức năng	Tính năng phụ
	Nhấn đồng thời cả ba phím cho tới khi đèn LED bàn phím nhấp sáng hai lần.



HyperX Alloy Elite 机械游戏键盘



产品型号		
Cherry® MX Blue	Cherry® MX Brown	Cherry® MX Red
HX-KB2BL1-UK/R1	HX-KB2BR1-UK/R1	HX-KB2RD1-UK/R1
HX-KB2BL1-FR/R1	HX-KB2BR1-FR/R1	HX-KB2RD1-FR/R1
HX-KB2BL1-DE/R1	HX-KB2BR1-DE/R1	HX-KB2RD1-DE/R1
HX-KB2BL1-NO/R1	HX-KB2BR1-NO/R1	HX-KB2RD1-NO/R1
HX-KB2BL1-RU/R1	HX-KB2BR1-RU/R1	HX-KB2RD1-RU/R1
HX-KB2BL1-LA/R2	HX-KB2BR1-LA/R2	HX-KB2RD1-LA/R2
HX-KB2BL1-US/R1	HX-KB2BR1-US/R1	HX-KB2RD1-US/R1
HX-KB2BL1-US/R2	HX-KB2BR1-US/R2	HX-KB2RD1-US/R2



包含内容:







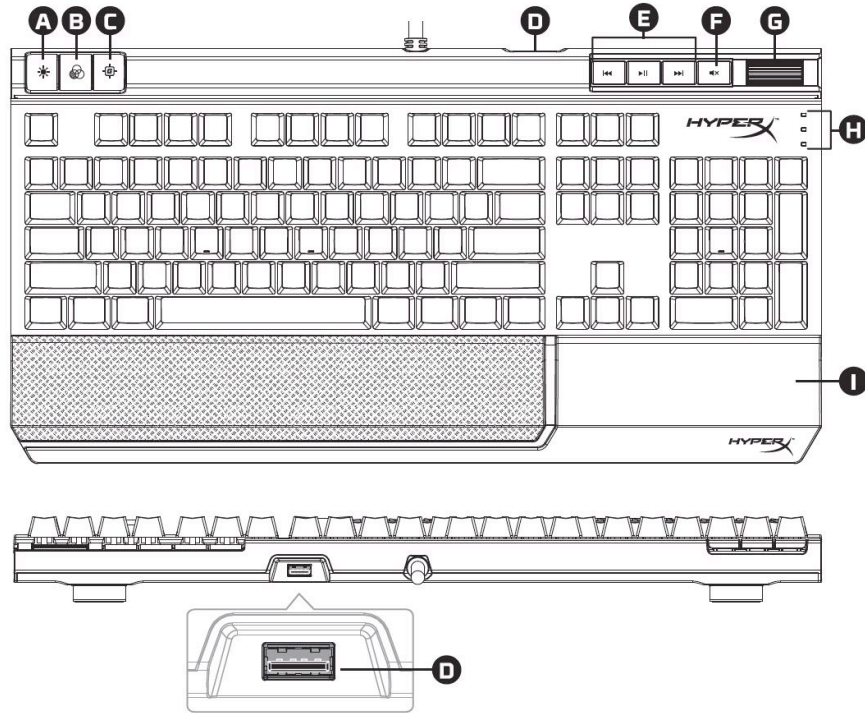

- HyperX Alloy Elite 机械游戏键盘
- 8 个游戏键帽
- 键帽工具
- 腕垫





键盘概览:

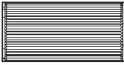

- A- 亮度控制按钮 
- B- LED 模式控制按钮 
- C- 游戏模式按钮 
- D- 背面 USB 端口 (USB 2.0 直通) 
- E- 媒体控制按钮 
- F- 静音按钮 
- G- 音量控制滚轮 
- H- 游戏模式/数字锁定键/大写锁定标识 
- I- 可拆卸的手托





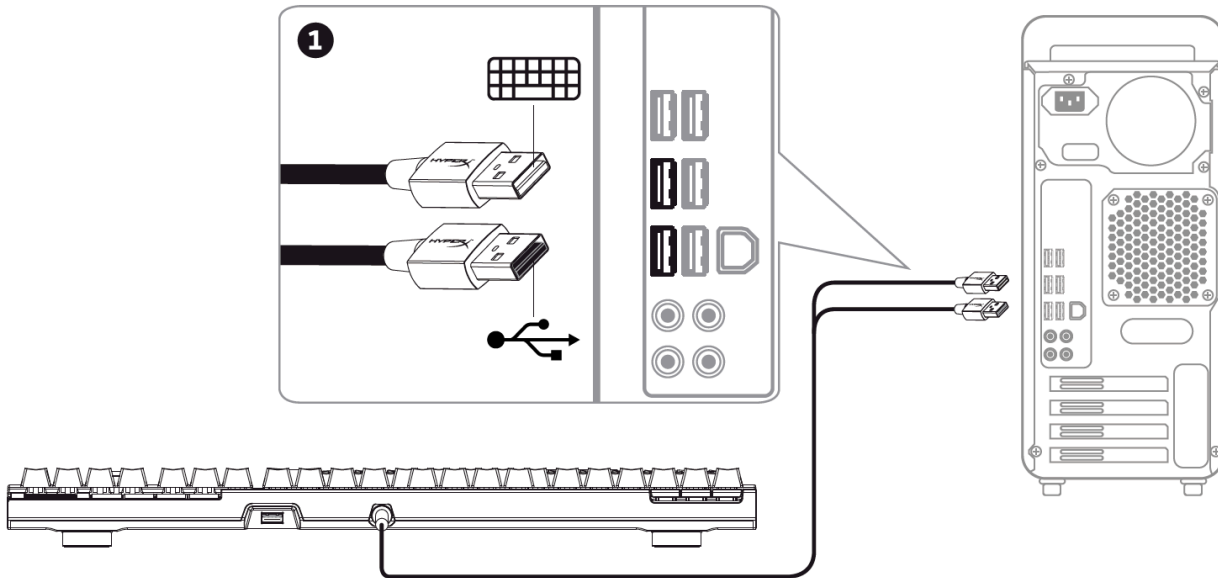

键盘安装：



1- 将两个 USB 接头连接到电脑。

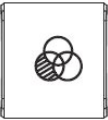

功能键：

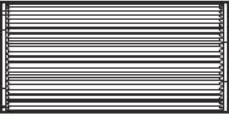
功能键	次要功能
	更改 LED 背光亮度。共有 4 个亮度级别：关闭、低、中和高。
	在 LED 背光模式之间切换。
	启动游戏模式  可禁用 Windows 键并防止意外中断游戏。启用游戏模式时，指示灯会亮起。
	可在聆听音乐或观看视频时，使用播放/暂停  、向后跳过  或向前跳过  功能。
	使计算机音频静音  。
	调高或调低计算机音量。



LED 背光模式:

共有 6 种 LED 背光模式: ▶ 常亮 (默认) ▶ 呼吸 ▶ 单点亮起 ▶ 扩散 ▶ 涟漪 ▶ 自定义。



常亮: 持续发光 (默认设置)。



呼吸: 像呼吸一样有节奏地闪烁。



单点亮起: 按下之后, 单个按键会亮起, 一秒钟后慢慢消失。



扩散: 按下之后, 单个按键发出的灯光效果。





涟漪: 按键以波浪形方式从左到右依次亮起。



自定义: 可以选择您希望亮起的按键。

按照如下步骤进行自定义设置:

- 1- 将背光模式切换到自定义。

- 2- 按住  +  直到背光灯熄灭。

- 3- 按住一个或多个您希望亮起背光的按键。

- 4- 完成后, 再次按下  +  即可保存自定义的背光灯配置文件。



键盘恢复出厂设置:

如果遇到任何键盘问题，可以执行恢复出厂设置。这样会失去自定义的 LED 配置文件。

功能键	次要功能
	同时按下三个按键，直到键盘 LED 背光灯闪烁两次。



HyperX Alloy Elite 機械式電競鍵盤



產品型號		
Cherry® MX 青軸款	Cherry® MX 茶軸款	Cherry® MX 紅軸款
HX-KB2BL1-UK/R1	HX-KB2BR1-UK/R1	HX-KB2RD1-UK/R1
HX-KB2BL1-FR/R1	HX-KB2BR1-FR/R1	HX-KB2RD1-FR/R1
HX-KB2BL1-DE/R1	HX-KB2BR1-DE/R1	HX-KB2RD1-DE/R1
HX-KB2BL1-NO/R1	HX-KB2BR1-NO/R1	HX-KB2RD1-NO/R1
HX-KB2BL1-RU/R1	HX-KB2BR1-RU/R1	HX-KB2RD1-RU/R1
HX-KB2BL1-LA/R2	HX-KB2BR1-LA/R2	HX-KB2RD1-LA/R2
HX-KB2BL1-US/R1	HX-KB2BR1-US/R1	HX-KB2RD1-US/R1
HX-KB2BL1-US/R2	HX-KB2BR1-US/R2	HX-KB2RD1-US/R2

**內容物：**







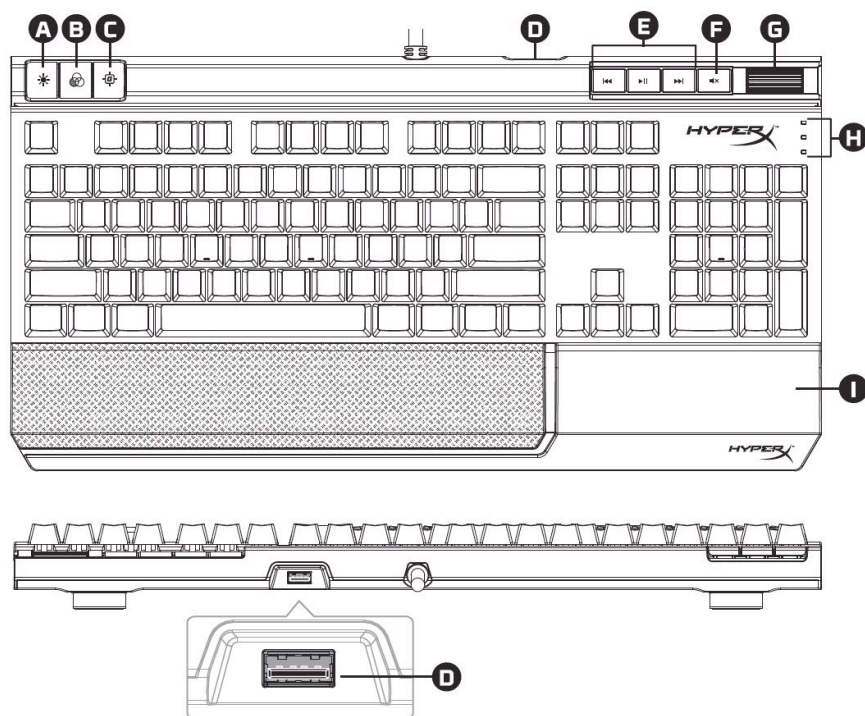

- HyperX Alloy Elite 機械式電競鍵盤
- 8 顆遊戲鍵帽
- 拔鍵器
- 可拆式手托





鍵盤概覽：



- A- 亮度控制鍵 
- B- LED 模式控制鍵 
- C- 遊戲模式鍵 
- D- 後方 USB 連接埠 (USB 2.0 pass-through) 
- E- 媒體控制鍵 
- F- 音量靜音鍵 
- G- 音量控制滾輪 
- H- 遊戲模式 / 數字鎖定 / 大寫鎖定指示燈 
- I- 可拆式手托





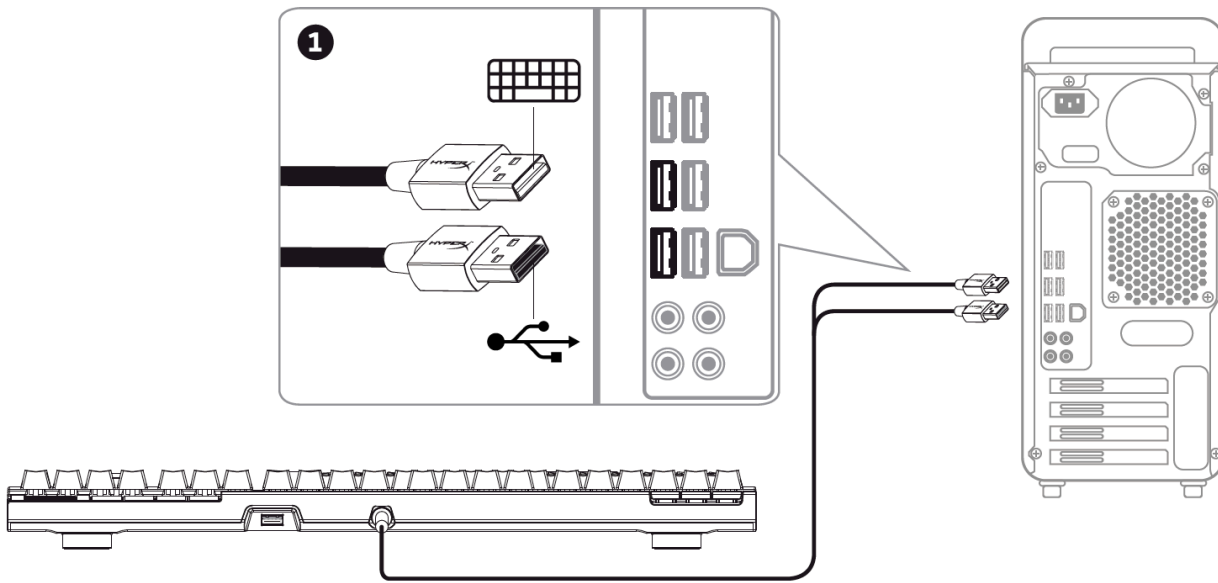



安裝說明：

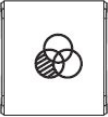

- 1- 將兩組 USB 接頭連接至電腦。



功能鍵：

功能鍵	次要功能
	變更 LED 背光的亮度。本產品共有 4 個亮度等級：關閉、低、中，和高。
	切換 LED 背光模式。
	啟用遊戲模式  來停用 Windows 鍵，並預防遊戲中發生誤觸干擾。當遊戲模式啟用時，指示燈亮起。
	聽音樂或看影片時，播放/暫停  、倒轉  或快轉  。
	靜音  電腦音效。
	提高或降低電腦音量。



LED 背光模式：

本產品有 6 種 LED 背光模式：▶ 恆亮 (預設) ▶ 呼吸 ▶ 單點 ▶ 爆破 ▶ 波浪 ▶ 自訂。



恆亮：持續發光（預設值）。



呼吸：模仿呼吸節奏，緩慢地閃爍。



單點：單獨按鍵將會於按下時亮起，並於一秒鐘後慢慢熄滅。



爆破：按下單獨按鍵時，將會產生放射性燈光效果。





波浪：按鍵將會由左至右以波浪形式亮起。





自訂：你可以選擇你希望亮起的按鍵。

依照以下步驟來設定自訂模式：

1- 將背光模式切換至自訂：

2- 長按  +  直到背光關閉。

3- 按下你希望啟用背光的按鍵。

4- 結束時，再次按下  +  來儲存你的背光設定檔。



還原原廠設定：

如果你的鍵盤有任何問題，你可以將鍵盤還原為原廠設定。此舉會讓自訂的 LED 設定消失。

功能鍵	次要功能
	同時按住三個按鍵，直到鍵盤 LED 背光閃爍兩次。