

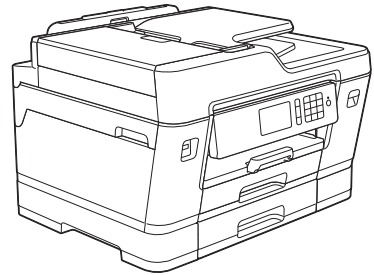

Reference Guide

Brief explanations for routine operations

MFC-J6930DW



Brother recommends keeping this guide next to your Brother machine for quick reference.



Online User's Guide

This *Reference Guide* contains basic instructions and information for your Brother machine. For more advanced instructions and information, see the *Online User's Guide* at solutions.brother.com/manuals



User's Guides and Where to Find Them

Which Guide?	What's in It?	Where Is It?
Product Safety Guide	Read this Guide first. Please read the Safety Instructions before you set up your machine. See this Guide for trademarks and legal limitations.	Printed / In the box
Quick Setup Guide	Follow the instructions for setting up your machine, and installing the drivers and software for the operating system and connection type you are using.	Printed / In the box
Reference Guide	Learn the basic PC-Print, Direct Print, Scan, Copy and Fax operations and basic machine maintenance. See troubleshooting tips.	Printed / In the box
Online User's Guide	<p>This guide includes the additional contents of the <i>Reference Guide</i>.</p> <p>In addition to information about the PC-Print, Direct Print, Scan, Copy, Fax, Internet services, Mobile Functions and Brother ControlCenter operations, useful information is included about using the machine on a network.</p>	Brother Solutions Center ¹
Mobile Print/Scan Guide for Brother iPrint&Scan	This Guide provides useful information about printing from your mobile device, and scanning from your Brother machine to your mobile device when connected to a Wi-Fi [®] network.	

¹ Visit solutions.brother.com/manuals.

1

General Information

Control Panel Overview

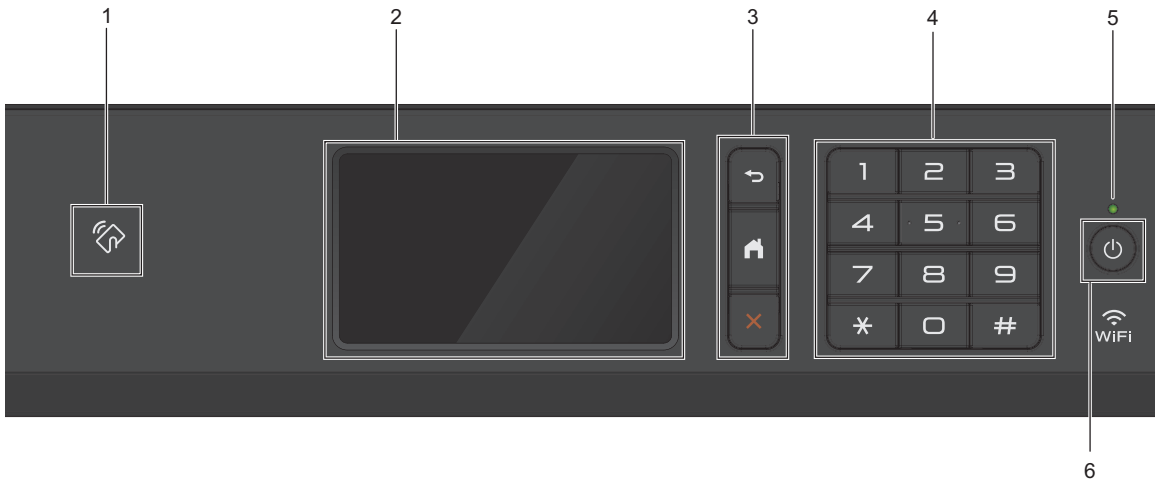

1. NFC (Near Field Communication) symbol

You can use card authentication by touching the IC card to the NFC symbol on the control panel.

If your Android™ device supports the NFC feature, you can print from your device or scan documents to your device in the same way.

2. **Touchscreen Liquid Crystal Display (LCD)**

Access menus and options by pressing them on the Touchscreen.

Adjust the angle of the control panel by lifting it.

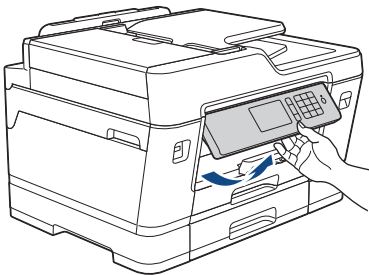

3. Menu buttons



Press to go back to the previous menu.



Press to return to the Home screen.



Press to cancel an operation.

4. Dial Pad

Press the numbers to dial telephone or fax numbers and to enter the number of copies.

5. LED Power Indicator

The LED lights up depending on the machine's power status.

When the machine is in Sleep Mode, the LED blinks.

6. Power On/Off

Press  to turn the machine on.

Press and hold down  to turn the machine off. The Touchscreen will display [Shutting Down] and will stay on for a few seconds before turning itself off. If you have connected an external telephone or TAD, it is always available.

If you turn the machine off using , it will still clean the print head periodically to maintain print quality. To prolong print head life, provide better ink efficiency, and maintain print quality, keep your machine connected to a power source at all times.

Touchscreen LCD Overview

There are three Home screens that you can access by swiping left or right or pressing ◀ or ▶.

From the Home screens, you can access Shortcuts, Wi-Fi setup, Settings and Ink levels screens.

Home Screen 1

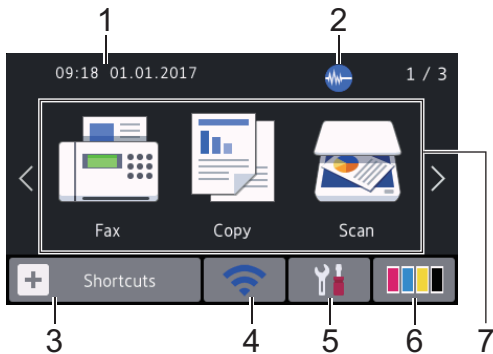

This screen shows the machine's status when the machine is idle. This Home screen is also called the Ready Mode screen. When displayed, it indicates that your machine is ready for the next command.



You can change the Ready Mode screen.

For more information, see the *Online User's Guide: Set the Ready Screen*.

Home Screen 1 provides access to [Fax], [Copy] and [Scan] operations.

Home Screen 2

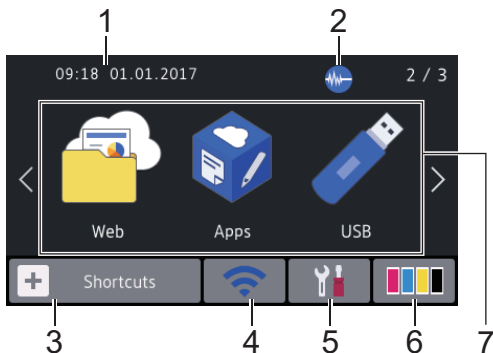

Home Screen 2 provides access to additional features, such as [Web], [Apps] and [USB] operations.

Home Screen 3

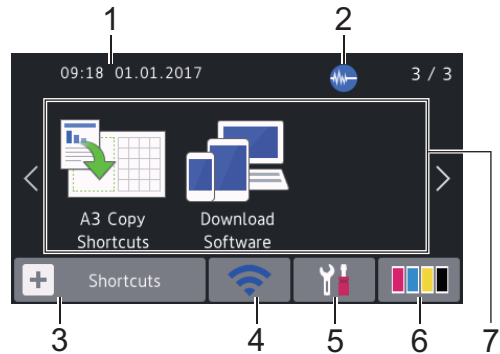

Home Screen 3 provides access to additional features, such as [A3 Copy Shortcuts] and [Download Software] operations.

1. Date & Time

Displays the date and time set on the machine.

2. Quiet Mode

This icon appears when the [Quiet Mode] setting is set to [On].

The Quiet Mode setting can reduce printing noise. When Quiet Mode is turned on, the print speed becomes slower.

3. [Shortcuts]



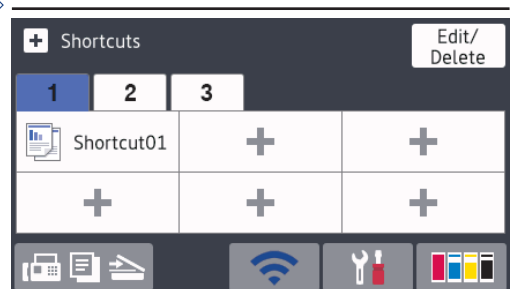

Create Shortcuts for frequently-used operations, such as sending a fax, copying, scanning, Web Connect and Apps services.





- Three Shortcuts tabs are available with six Shortcuts on each tab.
- Press , displayed at the bottom of the screen to access the Home Screens.

4.  **Wireless Status**

Each icon in the following table shows the wireless network status:

	<p>Your machine is not connected to the wireless access point.</p> <p>Press this button to configure wireless settings. For more information, see the <i>Quick Setup Guide</i>.</p>
	<p>Wireless network is connected.</p> <p>A three-level indicator in each of the Home screens displays the current wireless signal strength.</p>
	<p>The wireless access point cannot be detected.</p>
	<p>The wireless setting is disabled.</p>

 You can configure wireless settings by pressing the Wireless Status button.

5.  **[Settings]**

Press to access the [Settings] menu.

6.  **[Ink]**

Displays the available ink volume. Press to access the [Ink] menu.

When an ink cartridge is near the end of its life or having a problem, an error icon is displayed on the ink colour.

7. **Modes:**

-  **[Fax]**

Press to access Fax mode.

-  **[Copy]**

Press to access Copy mode.

-  **[Scan]**

Press to access Scan mode.

-  **[Web]**

Press to connect the Brother machine to an Internet service.

For more information, see the *Online User's Guide*.

-  **[Apps]**

Press to connect the Brother machine to the Brother Apps service.

For more information, see the *Online User's Guide*.

-  **[USB]**

Press to access the [USB] menu.

-  **[A3 Copy Shortcuts]**

Press to copy to A3 or Ledger size paper using this preset menu.

-  **[Download Software]**

Press to display information about downloading and installing software for mobile devices and computers.

8. **[Stored Fax(es) :]**

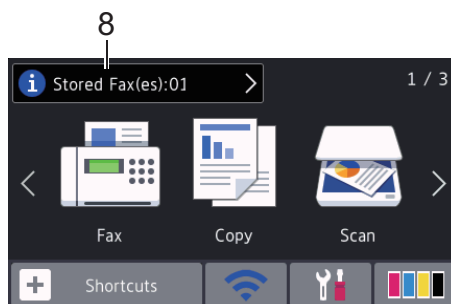

[Stored Fax(es)] displays how many received faxes are in the machine's memory.

Press  to print the faxes.

9. [New Fax(es) :]

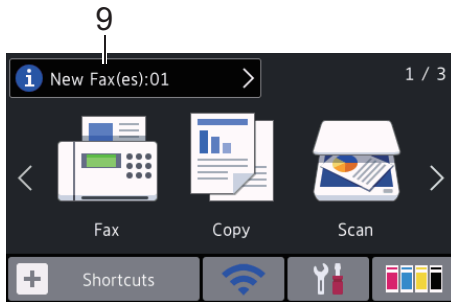

When [Fax Preview] is set to [On], [New Fax(es)] displays how many new faxes you have received and stored in the memory.

Press to view the faxes on the Touchscreen.



If you receive a fax containing multiple paper sizes (for example, a page of A4 data and a page of A3 data), the machine may create and store a file for each paper size, so the Touchscreen may show that more than one fax job has been received.

10. Warning icon

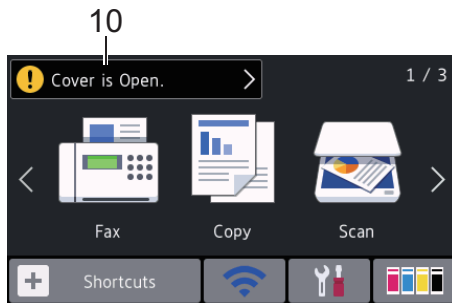

The warning icon appears when there is an error or maintenance message; press to view the details, and then press to return to Ready mode.

IMPORTANT

DO NOT press the LCD with a sharp object such as a pen or stylus. It may damage the machine.



- This product adopts the font of ARPHIC TECHNOLOGY CO.,LTD.
- DO NOT touch the LCD immediately after plugging in the power cord or turning on the machine. Doing this may cause an error.

New Information from Brother

New information from Brother appears in the information bar when the notification settings such as [Message from Brother] and [Firmware Auto Check] are set to [On].

Press to view the details.



Internet connection is needed, and data rates may apply.

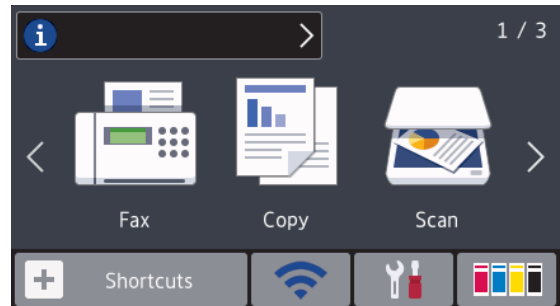

Access Brother Utilities (Windows®)

Brother Utilities is an application launcher that offers convenient access to all Brother applications installed on your computer.

1 Do one of the following:

- Windows Vista® and Windows® 7

Click (Start) > All Programs > Brother > Brother Utilities.

- Windows® 8

Tap or click  (**Brother Utilities**) either on the **Start** screen or the desktop.

- Windows® 8.1

Move your mouse to the lower left corner of the **Start** screen and click  (if using a touch-based device, swipe up from the bottom of the **Start** screen to bring up the **Apps** screen).

When the **Apps** screen appears, tap or click  (**Brother Utilities**).

- Windows® 10

Click  > **All apps** > **Brother** > **Brother Utilities**.

2 Select your machine.

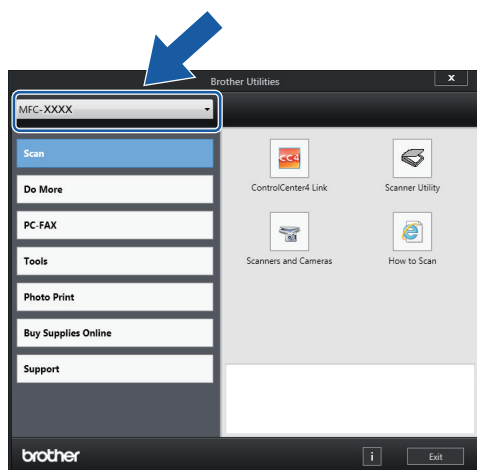

3 Select the operation you want to use.

Uninstall the Brother Software and Drivers (Windows®)

- 1 Launch  (**Brother Utilities**).

- 2 Click the drop-down list, and then select your model name (if not already

selected). Click **Tools** in the left navigation bar, and then click **Uninstall**.

Follow the instructions in the dialog box to uninstall the software and drivers.

2

Paper Handling

Load Paper

1 Load the paper in the paper tray as follows.



Fan the stack of paper well.



The paper size determines the orientation when loading paper.

Tray #1	Tray #2	How to Load Paper	
A4 Letter Executive	A4 Letter (Plain paper and Recycled paper only)		<p>Adjust the paper guides.</p> <p>→</p> <p>Landscape orientation</p>
A5 A6 Photo Photo L Photo 2L Index card Envelopes	-		<p>Adjust the paper guides.</p> <p>→</p> <p>Portrait orientation</p>
A3 Ledger Legal Folio Mexico Legal India Legal	A3 Ledger Legal Folio Mexico Legal India Legal (Plain paper and Recycled paper only)		<p>Extend the tray using the green slider, then adjust the paper guides.</p> <p>→</p> <p>Portrait orientation</p>

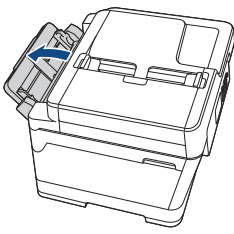
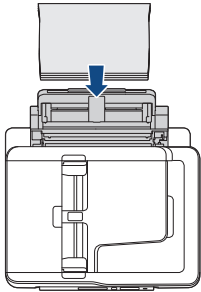
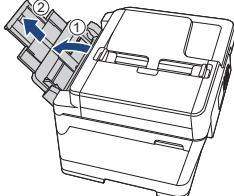
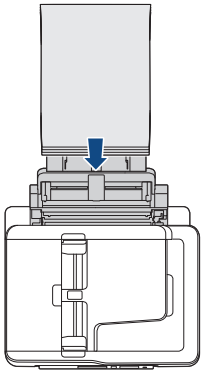
MP Tray	How to Load Paper	
A4 Letter Executive		Landscape orientation 
A3 Ledger Legal Folio Mexico Legal India Legal A5 A6 Photo Photo L Photo 2L Index card Envelopes		Portrait orientation 

For more information, see the *Online User's Guide: Load Paper*.

2 Unfold the paper support flap.

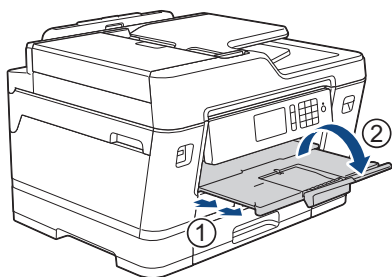

3 Change the paper size setting in the machine's menu, if needed.

Load Documents

Load Documents in the Automatic Document Feeder (ADF)

- 1 Fan the pages well.
- 2 Adjust the paper guides (1) to fit the document size.

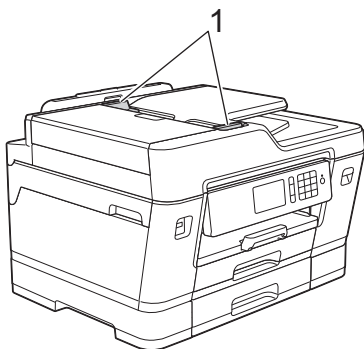

- 3 Place your document *face up* in the ADF, as shown in the illustration, until you feel the document touch the feed rollers and the machine beeps.

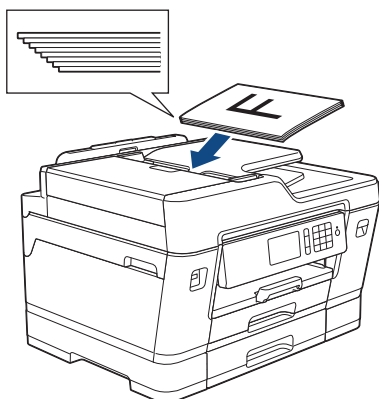

Load Documents on the Scanner Glass

- 1 Lift the document cover.

- 2 Place the document *face down* in the upper left corner of the scanner glass as shown in the illustration.

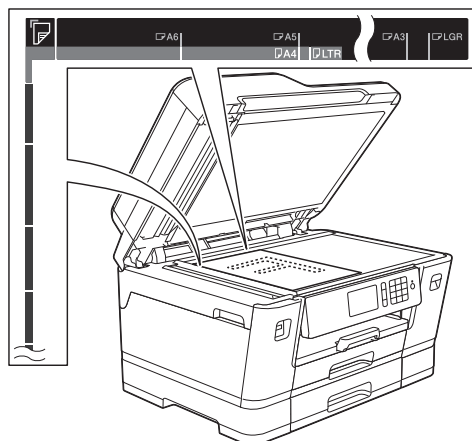

- 3 Close the document cover.

Print from Your Computer

Before attempting any printing operation, confirm the following:

- Make sure you have installed the Brother software and drivers.
- For USB or network cable users: Make sure the interface cable is inserted correctly.

Print a Document (Windows®)

- 1 Select the print command in your application.
- 2 Select **Brother MFC-XXXX Printer** (where XXXX is the name of your model).
- 3 Click **Print**.
- 4 Complete your print operation.

Print a Document (Macintosh)

- 1 From an application, such as Apple TextEdit, click the **File** menu, and then select **Print**.
- 2 Select **Brother MFC-XXXX** (where XXXX is the name of your model).
- 3 Click **Print**.

- 4 Complete your print operation.

Various Printing

To use the various printing features, click the printing properties or preferences button to change the printer setting.

Print on Both Sides of the Paper Automatically

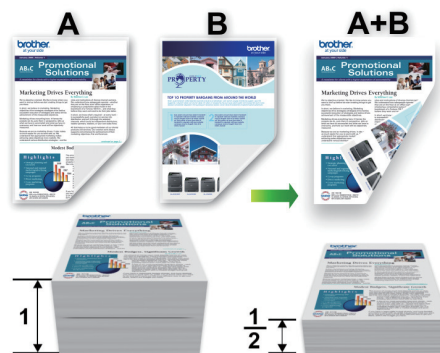

Print More Than One Page on a Single Sheet of Paper (N in 1)



For Windows®:

For more information, see the *Online User's Guide: Print from Your Computer (Windows®)*.

For Macintosh:

For more information, see the *Online User's Guide: Print from Your Computer (Macintosh)*.

Print Photos Directly from a USB Flash Drive

Preview and Print Photos from a USB Flash Drive

Preview your photos on the LCD before you print them. Print images that are stored on a USB flash drive.

- 1 Put a USB flash drive in the USB slot.

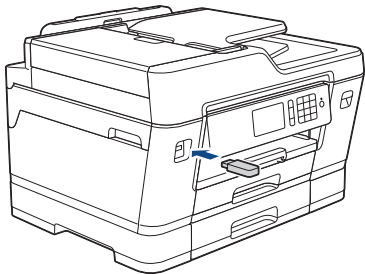

- 2 Press [JPEG Print] > [Select Files].
- 3 Swipe left or right or press ◀ or ▶ to display the photo you want to print, and then press it.

 To print all photos, press [Print All], and then press [Yes] to confirm.

- 4 Press × **01** to display the keyboard on the Touchscreen, and then enter the number of copies using the Touchscreen keyboard. Press [OK].

You can also press [-] or [+] on the Touchscreen, or use the dial pad numbers.

- 5 Press [OK].
- 6 Repeat the last three steps until you have selected all the photos you want to print.

- 7 Press [OK].
- 8 Read and confirm the displayed list of options.
- 9 To change the print settings, press [Print Settings].
When finished, press [OK].
- 10 Press [Start].

Print Settings Overview

The Print Settings you change are temporary for your current printout. The machine returns to its default settings after printing is complete.

 You can save the print settings you use most often by setting them as the default. For more information, see the *Online User's Guide*.

Copy a Document

- 1 Make sure you have loaded the correct size paper in the paper tray.
- 2 Load your document.

- 3 Press  [Copy].

The Touchscreen displays:

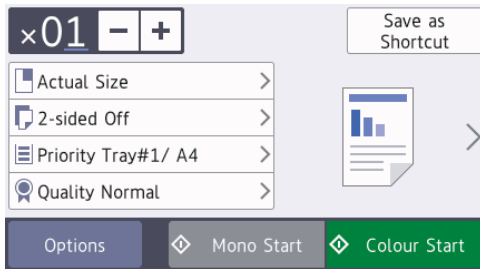

- 4 Change the copy settings, if needed.



When you load paper other than A4 size Plain Paper, you must change the [Paper Size] and [Paper Type] settings by pressing [Options].

- **x01** (No. of Copies)

Press **x01** to display the keyboard on the Touchscreen, and then enter the number of copies using the Touchscreen keyboard. Press [OK].

You can also press [-] or [+] on the Touchscreen, or use the dial pad numbers.

- [Options]

Press **Options** to change the copy settings for the next copy only.

When you have finished changing settings, press [OK].



After you have finished selecting new options, you can save them by pressing the [Save as Shortcut] button.

- 5 Press [Mono Start] or [Colour Start].



To stop copying, press .

Other Copy Options

You can use various copy features by changing copy settings. Press the [Options] button.

Enlarge or Reduce Copied Images

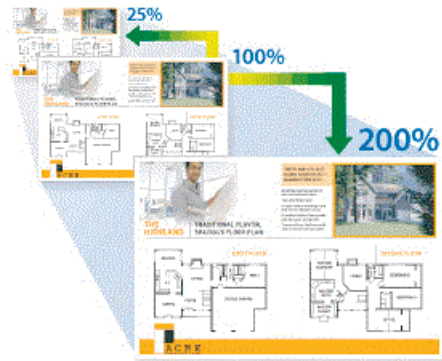

2-sided Copy

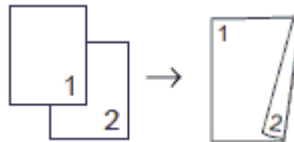

For more information, see the *Online User's Guide: Copy*.

Before Scanning

Before attempting to scan, confirm the following:

- Make sure you have installed the Brother software and drivers.
- For USB or network cable users: Make sure the interface cable is inserted correctly.



Scan from Your Computer

There are several ways you can use your computer to scan photos and documents on your Brother machine. Use the software applications provided by Brother, or use your favourite scanning application.

For more information, see the *Online User's Guide: Scan from Your Computer (Windows®)* or *Scan from Your Computer (Macintosh)*.

Scan Using the Scan Button on the Machine

Use the Scan button on the machine to make temporary changes to the scan settings. To make permanent changes, use Brother's ControlCenter software.

- 1 Load your document.
- 2 Press  [Scan].
- 3 Swipe left or right or press ◀ or ▶ to display  [to PC].

The icon moves to the middle of the Touchscreen and is highlighted in blue.

- 4 Press  [to PC].

- 5 Press [to File].

- 6 If the machine is connected over the network, swipe up or down or press ▲ or ▼ to display the computer where you want to send the data, and then press the computer name.



If the LCD prompts you to enter a PIN, use the LCD to enter the four-digit PIN for the computer, and then press [OK].

- 7 Do one of the following:
 - To change the settings, press [Options], and then go to the next step.
 - Press [Start] to start scanning without changing additional settings.

The machine starts scanning. If using the machine's scanner glass, follow the LCD instructions to complete the scanning job.

- 8 To scan both sides of the document, press [2-sided Scan], and then select the document type.

- 9 Change the scan settings you want to change, such as scan type, resolution, file type and document size, if needed. When finished, press [OK].

- 10 Press [Start].
The machine starts scanning. If using the machine's scanner glass, follow the LCD instructions to complete the scanning job.

Before Faxing

Telephone Line Interference/ VoIP

If you are having problems sending or receiving a fax due to possible interference on the telephone line or if you are using a VoIP system, we recommend changing the modem speed to minimise errors in fax operations.

1 Press  [Settings] > [All Settings] > [Initial Setup] > [Compatibility].

2 Press the option you want.

- [Basic (for VoIP)] reduces the modem speed to 9,600 bps and turns off colour fax receiving and ECM, except for colour fax-sending. Unless interference is a recurring problem on your telephone line, you may prefer to use it only when needed.

To improve compatibility with most VoIP services, Brother recommends changing the compatibility setting to [Basic (for VoIP)].

- [Normal] sets the modem speed at 14,400 bps.
- [High] sets the modem speed at 33,600 bps.

3 Press .

-  • VoIP (Voice over IP) is a type of phone system that uses an Internet connection, rather than a traditional phone line.



Related Information

- Error and Maintenance Messages on page 21

Send a Fax

1 Load your document in the ADF or place it on the scanner glass.

2 Press  [Fax].

 If [Fax Preview] is set to [On], press  [Fax] > [Sending Faxes].

The Touchscreen displays:

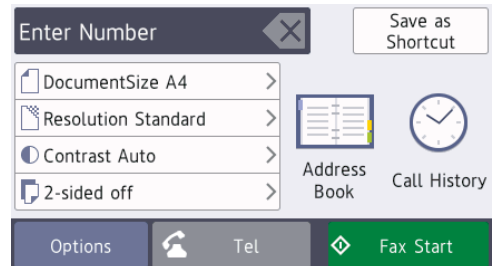

3 Enter the fax number in one of the following ways:

- Dial Pad (Enter the fax number manually.)

Press all digits of the number using the dial pad.

- [Redial] (Redial the last number you dialled.)

Press [Call History] > [Redial].

- [Outgoing Call] (Select a number from the Outgoing Call history.)

Press [Call History] > [Outgoing Call].

Select the number you want, and then press [Apply].

- [Caller ID History] (Select a number from the Caller ID history.)

Press [Call History] > [Caller ID History].

Select the number you want, and then press [Apply].

- [Address Book] (Select a number from the Address Book.)

Press [Address Book].

Do one of the following:

- Select the number you want, and then press [Apply].
- Press , and then enter the first letter of the name and press [OK]. Press the name you want to dial. If the name has two numbers, press the number you want. Press [Apply].



If the LDAP search is available, the result will be shown on the Touchscreen with



4 Press  [Document Size].

Select the document size option you want.

5 To change the fax settings, press [Options].

When finished, press [OK].

6 Press [Fax Start].

7 Do one of the following:

- If you are using the ADF, the machine starts scanning and sending the document.
- If you are using the scanner glass and selected [Mono] in the

[Colour Setting], the machine starts scanning the first page.

Go to the next step.

- If you are using the scanner glass and selected [Colour] in the [Colour Setting], the Touchscreen asks if you want to send a colour fax.

Press [Yes (Colour fax)] to confirm. The machine starts dialling and sending the document.

8 When the Touchscreen displays [Next Page?], do one of the following:

- Press [No] when finished scanning pages. The machine starts sending the document.
- Press [Yes] to scan another page. Place the next page on the scanner glass, and then press [OK]. The machine starts scanning the page.

Repeat this step for each additional page.

Choose the Correct Receive Mode

You must choose a Receive Mode depending on the external devices and telephone services you have on your line.

By default, your machine automatically will receive any faxes that are sent to it. The diagram below will help you select the correct mode.

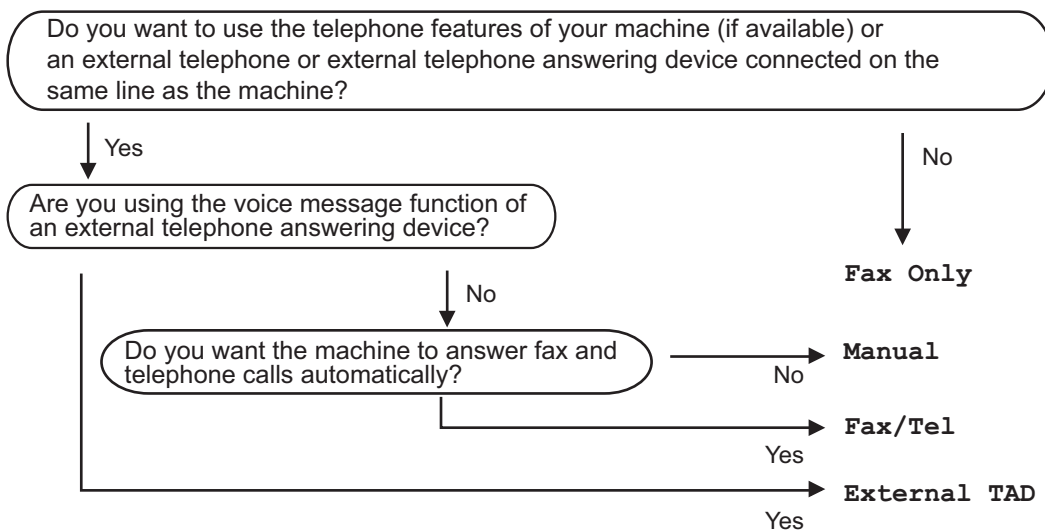

- 1 Press  [Settings] > [All Settings] > [Fax] > [Setup Receive] > [Receive Mode].



If the option to change the Receive Mode is unavailable, make sure the BT Call Sign feature is set to [Off].

- 2 Press the [Fax Only], [Fax/Tel], [External TAD] or [Manual] option.

- 3 Press .

Check the Print Quality

If faded or streaked colours and text appear or if text is missing on your printouts, the print head nozzles may be clogged. Print the Print Quality Check Sheet and look at the nozzle check pattern.

- 1 Press  [Ink] > [Improve Print Quality] > [Check Print Quality].



You can also press  [Settings] > [Maintenance] > [Improve Print Quality] > [Check Print Quality].

- 2 Press [Start].
The machine prints the Print Quality Check Sheet.
- 3 Check the quality of the four colour blocks on the sheet.
- 4 The Touchscreen asks about the print quality. Do one of the following:
 - If all lines are clear and visible, press [No], and then press  to finish the Print Quality check.
 - If lines are missing (see **Poor**, below), press [Yes].

OK

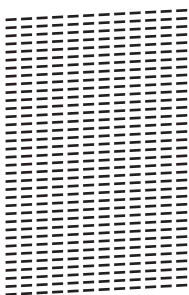

Poor

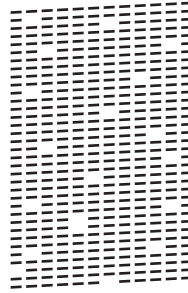

- 5 The Touchscreen asks you to check the print quality of each colour. Press the number of the pattern (1–4) that most closely matches the printing result.

- 6 Do one of the following:
 - If print head cleaning is needed, press [Start] to start the cleaning procedure.
 - If print head cleaning is not needed, the Maintenance screen reappears on the Touchscreen. Press .

- 7 After the cleaning procedure is finished, the Touchscreen asks if you want to print the Print Quality Check Sheet again. Press [Yes], and then press [Start].

The machine prints the Print Quality Check Sheet again. Check the quality of the four colour blocks on the sheet again.

If you clean the print head and the print has not improved, try installing a new Brother Original replacement ink cartridge for each problem colour. Try cleaning the print head again. If the print has not improved, contact Brother customer service or your local Brother dealer.

IMPORTANT

DO NOT touch the print head. Touching the print head may cause permanent damage and may void the print head's warranty.



When a print head nozzle is clogged, the printed sample looks like this.



After the print head nozzle is cleaned, the lines are gone.



Check the Print Alignment from Your Brother Machine

If your printed text becomes blurred or images become faded after transporting the machine, adjust the print alignment.

- 1 Press  [Ink] > [Improve Print Quality] > [Alignment].



You can also press  [Settings] > [Maintenance] > [Improve Print Quality] > [Alignment].

- 2 Press [Next].

- 3 Swipe up or down or press ▲ or ▼ to display the paper size that needs a print alignment adjustment, and then press it.

- 4 Press [Basic alignment] or [Advanced alignment].

- 5 Load the selected paper size in the tray, and then press [Start].

The machine prints the Alignment Check Sheet.

(A)

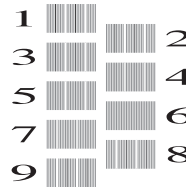

- 6 For the "A" pattern, swipe up or down or press ▲ or ▼ to display the number of the test print with the least visible vertical stripes (1-9), and then press it (in the example, number 6 is the best choice). Press [OK].

Repeat this step for the rest of the patterns.



When the print alignment is not adjusted correctly, text looks blurry like this.

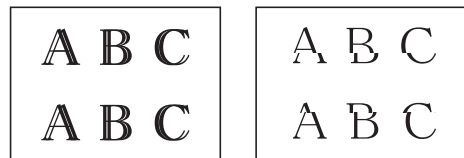

After the print alignment is adjusted correctly, text looks like this.



- 7 Press .



Use this section to resolve problems you may encounter when using your Brother machine.

Identify the Problem

Even if there seems to be a problem with your machine, you can correct most problems yourself.

First, check the following:

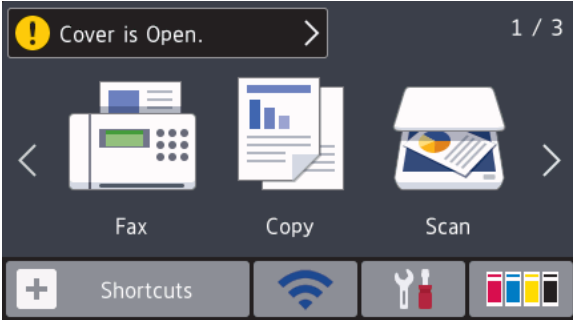
- The machine's power cord is connected correctly and the machine's power is on.
- All of the machine's orange protective parts have been removed.
- The ink cartridges are installed correctly.
- The Scanner Cover and the Jam Clear Cover are fully closed.
- Paper is inserted correctly in the paper tray.
- The interface cables are securely connected to the machine and the computer, or the wireless connection is set up on both the machine and your computer.
- (For network models) The access point (for wireless), router, or hub is turned on and its link button is blinking.
- To find the error and the solution, check the LCD or the machine's status in **Status Monitor** on your computer.

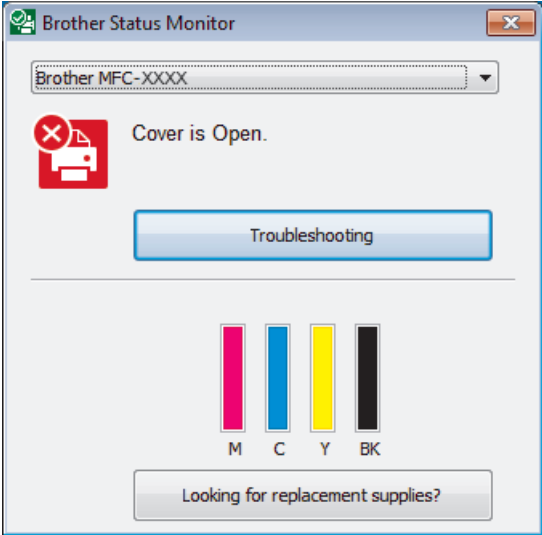
Using the LCD	Using the Status Monitor
<ol style="list-style-type: none"> 1. Follow the messages on the LCD. 2. See the instructions in the following Error and Maintenance Messages table. 3. If you cannot resolve the error, please refer to the <i>Online User's Guide: Error and Maintenance Messages</i>. 	<ul style="list-style-type: none"> • Double-click the  icon in the task tray. • Each colour of the icon indicates the machine's status. • Click the Troubleshooting button to access Brother's troubleshooting website. 

Error and Maintenance Messages

The most common error and maintenance messages are shown in the table. For more detailed information, see the *Online User's Guide*.

You can correct most errors and perform routine maintenance yourself. If you need more tips, go to your model's **FAQs & Troubleshooting** page on the Brother Solutions Center at support.brother.com.



If the Touchscreen displays errors and your Android™ device supports the NFC feature, touch your device to the NFC symbol on the control panel to access the Brother Solutions Center and browse the latest FAQs from your device. (Your mobile telephone provider's message and data rates may apply.)

Make sure the NFC settings of both your Brother machine and your Android™ device are set to On.

Error Message	Action
Black and White Print Only Replace ink.	<p>One or more of the colour ink cartridges have reached the end of their lives.</p> <p>Replace the ink cartridges.</p> <p>For more information, see the <i>Online User's Guide: Replace the Ink Cartridges</i>.</p> <p>The machine may stop all print operations and you may not be able to use the machine until you install a new ink cartridge in the following cases:</p> <ul style="list-style-type: none"> • If you unplug the machine or remove the ink cartridge. • If you select the Slow Drying Paper option on the machine or in the printer driver.
BT Call Sign On	<p>BT Call Sign is set to On. You cannot change the Receive Mode from Manual to another mode.</p> <p>Set BT Call Sign to Off.</p> <p>For more information, see the <i>Online User's Guide: Enable the Machine to Work with BT Call Sign (with Your External Telephone only)</i>.</p>
Cannot Detect	<p>Take out the new ink cartridge and reinstall it slowly and firmly until it locks into place.</p> <p>For more information, see the <i>Online User's Guide: Replace the Ink Cartridges</i>.</p>
	<p>Remove the used ink cartridge and install a new one.</p>
	<p>Replace the cartridge with a Brother Original ink cartridge. If the error message remains, contact Brother customer service or your local Brother dealer.</p>
	<p>Slowly turn the ink cartridge so that the ink supply port is pointing downwards, and then reinstall the cartridge.</p>

Error Message	Action
Cannot Detect	<p>Check the model numbers of the ink cartridges and install the correct ink cartridges.</p> <p>See <i>Related Information: Supply Specifications</i> at the end of this section.</p>
Cannot Detect Ink Volume	<p>Replace the cartridge with a Brother Original ink cartridge. If the error message remains, contact Brother customer service or your local Brother dealer.</p>
Data Remaining in Memory	<p>Press . The machine will cancel the job and clear it from the memory. Try to print again.</p>
Disconnected	<p>Try to send or receive again.</p> <p>If calls are stopped repeatedly and you are using a VoIP (Voice over IP) system, try changing the Compatibility to Basic (for VoIP).</p> <p>See <i>Related Information: Telephone Line Interference/VoIP</i> at the end of this section.</p>
Document Jam/too Long	<p>The document was not inserted or fed correctly, or the document scanned from the ADF was too long.</p> <p>For more information, see the <i>Online User's Guide: Document Jams</i>.</p>
High Temperature	<p>After cooling the room, allow the machine to cool down to room temperature. Try again when the machine has cooled down.</p>
Hub is Unusable.	<p>Hubs, including a USB flash drive with a built-in hub, are not supported. Unplug the device from the USB direct interface.</p>
Ink Absorber NearFull	<p>The ink absorber box or flushing box must be replaced soon. Contact Brother customer service or your local Brother dealer.</p>
Ink Absorber Pad Full	<p>The ink absorber box or flushing box must be replaced. Contact Brother customer service or your local Brother Authorised Service Centre to have your machine serviced.</p> <p>Reasons for cleaning are:</p> <ol style="list-style-type: none"> 1. The machine automatically cleans itself after you remove the power cord and plug it back in. 2. After a paper jam has been cleared, the machine automatically cleans itself before the next received page is printed. 3. The machine automatically cleans itself after sitting idle for more than 30 days (infrequent use). 4. The machine automatically cleans itself after ink cartridges of the same colour have been replaced 12 times.

Error Message	Action
Ink Low	<p>One or more of the ink cartridges are near the end of their lives.</p> <p>Order a new ink cartridge. You can continue printing until the Touchscreen displays <i>Replace Ink</i>.</p> <p>For more information, see the <i>Online User's Guide: Replace the Ink Cartridges</i>.</p> <ul style="list-style-type: none"> • You can still scan even if the ink is low or needs to be replaced.
Install Ink	<p>Remove the new ink cartridge and re-install it slowly and firmly until it locks into place.</p> <p>For more information, see the <i>Online User's Guide: Replace the Ink Cartridges</i>.</p>
Jam Front/Rear Jam Front Jam Rear Jam MP Tray Jam Front/MP Tray Jam Tray2 Repeat Jam XX	<p>Remove the jammed paper.</p> <p>For more information, see the <i>Online User's Guide: Printer Jam or Paper Jam</i>.</p> <p>If there is a repeat paper jam, try another paper jam clear operation.</p> <p>For more information, see the <i>Online User's Guide: Remove Paper Scraps</i>.</p> <p>Make sure the paper guides are set to the correct paper size.</p> <p>Make sure the paper support is fully inserted into the machine.</p> <p>For more information, see the <i>Online User's Guide: Paper is Jammed in the Front of the Machine</i>.</p> <p>Clean the paper pick-up rollers.</p> <p>For more information, see the <i>Online User's Guide: Clean the Paper Pick-up Rollers</i>.</p>
Low Temperature	<p>After warming the room, allow the machine to warm up to room temperature. Try again when the machine has warmed up.</p>
Media is Full.	<p>Your machine can only save to your USB flash drive if it contains fewer than 999 files. Delete unused files and try again.</p> <p>Delete unused files from your USB flash drive to make some free space, and then try again.</p>
No Caller ID	<p>There is no incoming call history. You did not receive calls or you have not subscribed to the Caller ID service from your telephone company.</p> <p>To use the Caller ID feature, contact your telephone company.</p> <p>For more information, see the <i>Online User's Guide: Caller ID</i>.</p>

Error Message	Action
<p>No Paper Fed</p> <p>No Paper Fed [Tray #1]</p> <p>No Paper Fed [MP Tray]</p> <p>No Paper Fed [Tray #2]</p>	<p>Do one of the following:</p> <ul style="list-style-type: none"> • Refill the paper tray, and then follow the LCD instructions. • Remove and reload the paper, and then follow the LCD instructions. <p>The paper was not inserted in the centre position of the MP tray.</p> <p>Remove the paper and reinsert it in the centre of the MP tray, and then follow the LCD instructions.</p> <p>For more information, see the <i>Online User's Guide: Load Paper in the Multi-purpose Tray (MP Tray)</i>.</p> <p>The Jam Clear Cover is not closed correctly.</p>
<p>Out of Fax Memory</p>	<p>Do one of the following:</p> <ul style="list-style-type: none"> • Clear the data from the memory. To gain extra memory, you can turn Memory Receive off. <p>For more information, see the <i>Online User's Guide: Turn Off Memory Receive</i>.</p> <ul style="list-style-type: none"> • Print the faxes stored in the memory. <p>For more information, see the <i>Online User's Guide: Print a Fax Stored in the Machine's Memory</i>.</p>
<p>Out of Memory</p>	<p>If a fax-sending or copy operation is in progress:</p> <ul style="list-style-type: none"> • Press  or <code>Quit</code> or <code>Close</code> and wait until the other operations that are in progress finish, and then try again. • Press <code>Send Now</code> to send the pages scanned so far. • Press <code>Partial Print</code> to copy the pages scanned so far. • Clear the data in the memory. To gain extra memory, you can turn Memory Receive off. <p>For more information, see the <i>Online User's Guide: Turn Off Memory Receive</i>.</p> <ul style="list-style-type: none"> • Print the faxes stored in the memory. <p>For more information, see the <i>Online User's Guide: Print a Fax Stored in the Machine's Memory</i>.</p>

Error Message	Action
Paper Size Mismatch Paper Size Mismatch [Tray #1] Paper Size Mismatch [MP Tray] Paper Size Mismatch [Tray #2]	<ol style="list-style-type: none"> 1. Check that the paper size you selected on the machine's display matches the size of the paper in the tray. For more information, see the <i>Online User's Guide: Change the Paper Size and Paper Type</i>. 2. Make sure you loaded the paper in the proper orientation and set the paper guides at the indicators for your paper size. For more information, see the <i>Online User's Guide: Load Paper</i>. 3. After you have checked the paper size and the paper orientation, follow the LCD instructions. <p>If printing from your computer, make sure the paper size you selected in the printer driver matches the size of paper in the tray. For more information, see the <i>Online User's Guide: Print Settings (Windows®)</i> or <i>Print Options (Macintosh)</i>.</p>
Paper Tray #1 not detected Paper Tray #2 not detected	<p>Slowly push the paper tray completely into the machine.</p> <p>Paper or a foreign object has prevented the paper tray from being inserted properly.</p> <p>Pull the paper tray out of the machine, and remove the jammed paper or foreign object. If you cannot find or remove the jammed paper, see the <i>Online User's Guide: Printer Jam or Paper Jam</i>.</p>
Repetitive No Paper Fed	<p>Clean the paper pick-up rollers.</p> <p>For more information, see the <i>Online User's Guide: Clean the Paper Pick-up Rollers</i>.</p>
Repetitive Paper Jams	<p>Remove any foreign objects and paper scraps in the machine.</p> <p>For more information, see the <i>Online User's Guide: Remove Paper Scraps</i>.</p>
Replace Ink	<p>One or more of the ink cartridges have reached the end of their lives. Replace the ink cartridges.</p> <p>For more information, see the <i>Online User's Guide: Replace the Ink Cartridges</i>.</p> <ul style="list-style-type: none"> • You can still scan even if the ink is low or needs to be replaced.
Sending Error Wrong Document Size Settings	<p>Select the correct document size option, and then press Fax Start again.</p>

Error Message	Action
<p>Touchscreen Initialisation Failed</p>	<p>The Touchscreen was pressed before the power on initialisation was completed.</p> <p>Make sure nothing is touching or resting on the Touchscreen, especially when plugging the machine in.</p> <p>Debris may be stuck between the lower part of the Touchscreen and its frame.</p> <p>Insert a piece of stiff paper between the lower part of the Touchscreen and its frame and slide it back and forth to push out the debris.</p>
<p>Tray #1 Settings Tray #2 Settings MP Tray Settings</p>	<p>This message is displayed when the setting to confirm the paper type and size is enabled.</p> <p>To not display this confirmation message, change the setting to Off.</p> <p>For more information, see the <i>Online User's Guide: Change the Check Paper Size Setting</i>.</p>
<p>Unable to Clean XX Unable to Initialize XX Unable to Print XX</p>	<p>A foreign object, such as a paper clip or a piece of ripped paper, is in the machine.</p> <p>Open the scanner cover and remove any foreign objects and paper scraps from inside the machine. If the error message continues, disconnect the machine from the power for several minutes, and then reconnect it.</p> <p>You can try additional paper jam clear operations.</p> <p>For more information, see the <i>Online User's Guide: Remove Paper Scraps</i>.</p> <p>If you cannot print received faxes, transfer them to another fax machine or to your computer.</p> <p>For more information, see the <i>Online User's Guide: Transfer Your Faxes or Fax Journal Report</i>.</p>
<p>Unable to Scan XX</p>	<p>Disconnect the machine from the power for several minutes, and then reconnect it.</p> <p>If you cannot print received faxes, transfer them to another fax machine or to your computer.</p> <p>For more information, see the <i>Online User's Guide: Transfer Your Faxes or Fax Journal Report</i>.</p>
<p>Unusable Device Disconnect device from front connector & turn machine off & then on</p>	<p>A broken device is connected to the USB direct interface.</p> <p>Unplug the device from the USB direct interface, then press  to turn the machine off and then on again.</p>
<p>Unusable Device Please disconnect USB device.</p>	<p>A USB device or USB flash drive that is not supported has been connected to the USB direct interface.</p> <p>Unplug the device from the USB direct interface. Turn the machine off and then on again.</p>

Error Message	Action
Wrong Ink Cartridge	<p>The ink cartridge model number is not compatible with your machine.</p> <p>Verify whether the cartridge model number will work with your machine.</p> <p>See <i>Related Information: Supply Specifications</i> at the end of this section.</p>
Wrong Ink Colour	<p>Check which ink cartridges are not matched by colour to their ink cartridge positions and move them to their correct positions.</p>
Wrong Tray Settings	<p>Follow the instructions on the Touchscreen and try to print again.</p>
	<p>Configure the paper size setting for the tray according to the LCD instructions.</p>

Related Information

- Telephone Line Interference/VoIP on page 15
 - Supply Specifications on page 30
-

Troubleshooting for Wireless LAN setup

Wireless LAN Report Error Codes

If the Wireless LAN Report shows that the connection failed, check the error code on the printed report and see the corresponding instructions in the table:

Error Code	Problem and Recommended Solutions
TS-01	The wireless setting is not activated, change the wireless setting to ON. If a network cable is connected to your machine, disconnect it and change the wireless setting of your machine to ON.
TS-02	The wireless access point/router cannot be detected. Do one of the following: <ul style="list-style-type: none">• Unplug the power to your wireless access point/router, wait for 10 seconds, and then plug it back in.• If your WLAN access point/router is using MAC address filtering, confirm that the MAC address of the Brother machine is allowed in the filter.• Check that you are selecting the correct SSID (network name) and are entering the correct network key.
TS-03	The wireless network and security setting you entered may be incorrect. Reconfirm the wireless network settings. If you do not know this information, ask your network administrator.
TS-04	Unsupported authentication/encryption method has been detected on your wireless access point/router. Your wireless access point/router is using an authentication/encryption method that is not supported by the device. Check that you are selecting the correct SSID (network name).
TS-05	The specified SSID and network key are incorrect. Check that you are selecting the correct SSID (network name) and are entering the correct network key.
TS-06	The specified wireless security information is incorrect. Check the authentication/encryption method that you are selecting and make sure you are entering the correct network key.
TS-07	The machine cannot detect a wireless access point/router that has WPS enabled. To configure your wireless settings using WPS, confirm that your wireless access point/router supports WPS and try again.
TS-08	Two or more wireless access points that have WPS enabled are detected. Try again after a few minutes to avoid interference from other access points.

Enter Text on Your Brother Machine

- The characters that are available may differ depending on your country.
- The keyboard layout may differ depending on the function you are setting.

When you need to enter text on your Brother machine, a keyboard will appear on the Touchscreen.



- Press to cycle between letters, numbers and special characters.
- Press to cycle between lowercase and uppercase letters.
- To move the cursor to the left or right, press ◀ or ▶.

Inserting spaces

- To enter a space, press [Space]. Or, you can press ▶ to move the cursor.

Making corrections

- If you entered an incorrect character and want to change it, press ◀ or ▶ to highlight the incorrect character. Press and then enter the correct character.

- To insert a character, press ◀ or ▶ to move the cursor to the correct place, and then enter the character.
- Press for each character you want to erase, or press and hold to erase all the characters.

Information for compliance with Commission Regulation 801/2013

Power consumption	MFC-J6930DW
Networked Standby ¹	Approx. 2.3 W

¹ All network ports activated and connected

How to enable/disable Wireless LAN

To turn on or off the wireless network connection, press [Settings] > [All Settings] > [Network] > [Network I/F] > [WLAN] or [Wired LAN].

Supply Specifications

Ink	The machine uses individual Black, Yellow, Cyan and Magenta ink cartridges that are separate from the print head assembly.
Service Life of Ink Cartridge	The first time you install a set of ink cartridges the machine will use an amount of ink to fill the ink delivery tubes for high quality printouts. This process will only happen once. After this process is complete the cartridges provided with your machine will have a lower yield than regular capacity cartridges (approximately 65%). With all following ink cartridges you can print the specified number of pages.
Replacement Supplies	<p><Super High Yield Black> LC3219XLBK <Super High Yield Yellow> LC3219XLY <Super High Yield Cyan> LC3219XLC <Super High Yield Magenta> LC3219XLM</p> <p>Black - Approximately 3000 pages ¹ Yellow, Cyan and Magenta - Approximately 1500 pages ¹</p> <p><High Yield Black> LC3217BK <High Yield Yellow> LC3217Y <High Yield Cyan> LC3217C <High Yield Magenta> LC3217M</p> <p>Black, Yellow, Cyan and Magenta - Approximately 550 pages ¹</p> <p>For more information about replacement supplies, visit us at www.brother.com/pageyield</p>
<p>What is Innobella?</p> 	<p>Innobella is a range of genuine supplies offered by Brother. The name "Innobella" derives from the words "Innovation" and "Bella" (meaning "Beautiful" in Italian) and is a representation of the "innovative" technology providing you with "beautiful" and "long lasting" print results.</p> <p>When you print photo images, Brother recommends Innobella glossy photo paper (BP71 series) for high quality. Brilliant prints are made easier with Innobella Ink and paper.</p>

¹ Approx. cartridge yield is declared in accordance with ISO/IEC 24711



If using Windows[®], double-click the **Brother Creative Center** icon  on your desktop to access our **FREE** website designed as a resource to help you easily create and print customised materials for business and home use with photos, text and creativity.

Mac users can access Brother CreativeCenter at this web address:
www.brother.com/creativecenter

Related Information

- Error and Maintenance Messages on page 21



brother

Visit us on the World Wide Web
www.brother.com

Made from 100% recycled paper
(excludes cover)



D00DJS001-00
UK
Version 0