

User's Manual

ColorEdge® CG248-4K/CG318-4K

Color Management LCD Monitor

Important

Please read PRECAUTIONS, this User's Manual, and the Setup Guide (separate volume) carefully to familiarize yourself with safe and effective usage.

- Please refer to the Setup Guide for basic information ranging from connection of the monitor to a PC or external device to using the monitor.
- The latest User's Manual is available for download from our web site:
<http://www.eizoglobal.com>



Location of Caution Statement

(Ex.CG318-4K)

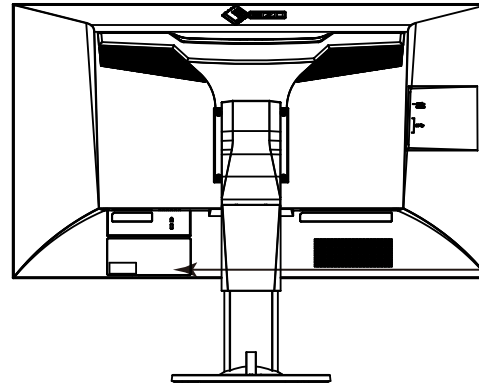



CAUTION
RISK OF ELECTRIC SHOCK. DO NOT OPEN.

ATTENTION
RISQUE DE CHOC ELECTRIQUE. NE PAS OUVRIR.

ACHTUNG
GEFAHR DES ELEKTRISCHEN SCHLAGES. RÜCKWAND NICHT ENTFERNEN.

警告
内有高压，严禁打开后盖。

警告
感電の恐れあり。カバーをあけないでください。

The equipment must be connected to a grounded main outlet.
L'appareil doit être relié à une prise avec terre.
Jordet stikkontakt skal benyttes når apparatet tilkobles datanett.
Apparaten skall anslutas till jordat nätuttag.
设备必须连接到接地地的电源插座。
電源コードのアースは必ず接地してください。

This product has been adjusted specifically for use in the region to which it was originally shipped. If operated outside this region, the product may not perform as stated in the specifications.

No part of this manual may be reproduced, stored in a retrieval system, or transmitted, in any form or by any means, electronic, mechanical, or otherwise, without the prior written permission of EIZO Corporation.

EIZO Corporation is under no obligation to hold any submitted material or information confidential unless prior arrangements are made pursuant to EIZO Corporation's receipt of said information. Although every effort has been made to ensure that this manual provides up-to-date information, please note that EIZO monitor specifications are subject to change without notice.

Notice for this monitor

Aside from general purposes like creating documents, viewing multimedia content, this product is also suited to applications such as creations of images and graphics, and digital photo processing, where accurate color reproduction is a priority.

This product has been adjusted specifically for use in the region to which it was originally shipped. If the product is used outside the region, it may not operate as specified in the specifications.

This product may not be covered by warranty for uses other than those described in this manual.

The specifications noted in this manual are only applicable when the following are used:

- Power cords provided with the product
- Signal cables specified by us

Only use optional products manufactured or specified by us with this product.

If you place this product on a lacquer-coated desk, the color may adhere to the bottom of the stand due to the composition of the rubber. Check the desk surface before use.

It takes about 3 minutes (under our measurement conditions) for the monitor display to stabilize. Please wait 3 minutes or more after the monitor power has been turned on, and then adjust the monitor.

It is necessary to wait at least 30 minutes after turning on the power, in order to obtain correct measurement results.

Monitors should be set to a lower brightness to reduce changes in luminosity caused by long-term use and maintain a stable display.

When the screen image is changed after displaying the same image for extended periods of time, an afterimage may appear. Use the screen saver or power save function to avoid displaying the same image for extended periods of time.

If the monitor displays continuously over a long period of time, dark smudges or burn-in may appear. To maximize the life of the monitor, we recommend the monitor be turned off periodically.

Periodic cleaning is recommended to keep the monitor looking new and to prolong its operation lifetime (refer to [“Cleaning” \(page 4\)](#)).

The LCD panel is manufactured using high-precision technology. Although, missing pixels or lit pixels may appear on the LCD panel, this is not a malfunction. Percentage of effective dots: 99.9994% or higher.

The backlight of the LCD panel has a fixed lifetime. When the screen becomes dark or begins to flicker, please contact your local EIZO representative.

Do not press on the panel or edge of the frame strongly, as this may result in display malfunctions, such as interference patterns, etc. If pressure is continually applied to the panel, it may deteriorate or damage your panel. (If the pressure marks remain on the panel, leave the monitor with a black or white screen. The symptom may disappear.)

Do not scratch or press on the panel with any sharp objects, as this may result in damage to the panel. Do not attempt to brush with tissues as this may scratch the panel.

When the monitor is cold and brought into a room or the room temperature goes up quickly, dew condensation may occur on the interior and exterior surfaces of the monitor. In that case, do not turn the monitor on. Instead wait until the dew condensation disappears, otherwise it may cause some damage to the monitor.

Cleaning

Attention

- Chemicals such as alcohol and antiseptic solution may cause gloss variation, tarnishing, and fading of the cabinet or panel, and also quality deterioration of the image.
 - Never use any thinner, benzene, wax, and abrasive cleaner, which may damage the cabinet or panel.
-

The stains on the cabinet and panel surface can be removed by using the provided ScreenCleaner.

To use the monitor comfortably

- An excessively dark or bright screen may affect your eyes. Adjust the brightness of the monitor according to the environmental conditions.
- Staring at the monitor for a long time tires your eyes. Take a 10-minute rest every hour.

Contents

- Notice for this monitor 3**
- Cleaning.....4
- To use the monitor comfortably4
- Contents 5**
- Chapter 1 Introduction 7**
- 1-1. Features.....7
- 1-2. Controls and Functions9
 - Front 9
 - Rear10
- 1-3. EIZO LCD Utility Disk11
 - Disk contents and software overview 11
 - To use ColorNavigator11
- 1-4. Supported Resolutions12
 - When using PC signal input12
 - When using Video signal input14
- 1-5. Setting the Resolution15
 - Windows15
 - Mac OS X 10.8 or later15
- Chapter 2 Basic Adjustments/Settings 16**
- 2-1. Switch Operation Method16
- 2-2. Switching Input Signals17
- 2-3. Switching the display mode (color mode)18
 - Display Modes18

- 2-4. Enlarging Images.....19
- 2-5. Setting the display method for colors outside the REC709 standard color gamut20
- Chapter 3 Advanced Adjustments/Settings 21**
- 3-1. Basic Operation of the Setting menu21
- 3-2. Setting Menu Functions.....22
 - Color22
 - SelfCalibration28
 - Signal Settings.....31
 - Preferences36
 - Languages.....39
 - Information.....39
- Chapter 4 Administrator Settings 40**
- 4-1. Basic Operation of the “Administrator Settings” menu40
- 4-2. “Administrator Settings” Menu Functions.....41
- Chapter 5 Troubleshooting 44**
- 5-1. No picture.....44
- 5-2. Imaging problems.....45
- 5-3. Other problems.....46
- 5-4. Built-in calibration sensor and SelfCalibration problems47
- Chapter 6 Reference 49**
- 6-1. Attaching the Optional Arm49

6-2. Attaching/Detaching Cable Holder	50
6-3. Connecting Multiple External Devices	52
6-4. Making Use of USB (Universal Serial Bus)	53
● Required System Environment.....	53
● Connection Procedure (Setup of USB Function).....	53
6-5. Specifications	54
● Dimensions.....	58
● Main Default Settings	62
● Accessories	63
Glossary	64
Appendix	67
Trademark.....	67
License / Copyright	68
FCC Declaration of Conformity	69
Hinweise zur Auswahl des richtigen Schwenkarms für Ihren Monitor.....	71
Hinweis zur Ergonomie :	71
LIMITED WARRANTY.....	72
Recycling Information	81
China Measures for RoHS Compliance in ChinaRoHS	86

Chapter 1 Introduction

Thank you very much for choosing an EIZO color LCD monitor.

1-1. Features

- CG248-4K: 23.8" widescreen/ CG318-4K: 31.1" widescreen
- Wide color gamut display
CG248-4K: Adobe® RGB coverage: 99%, DCI-P3 coverage: 93% / CG318-4K: Adobe® RGB coverage: 99%, DCI-P3 coverage: 98%
- Achieves contrast ratio of 1000:1 (CG248-4K) / 1500:1 (CG318-4K)^{*1}
A high contrast ratio allows display of crisper black with reduced whiteness.
^{*1} (typical) When "DUE Priority" is set to "Brightness"
- Resolution
CG248-4K: Supports a resolution of 3840 × 2160 / CG318-4K: Supports a resolution of 4096 × 2160
Can display 4K (3840 x 2160 / 4096 x 2160) resolution as is.
- Pixel density
CG248-4K: 185 ppi / CG318-4K: 149 ppi
Can display text and images in high definition.
- IPS panel with 89° horizontal and vertical wide viewing angles
- The time from switching on the monitor until the display is stable has been shortened to approximately 3 minutes ^{*2}
^{*2} According to EIZO measurement conditions. However, if performing SelfCalibration ([page 28](#)), it is necessary to wait at least 30 minutes after turning on the power, in order to obtain correct measurement results.
- Frame synchronization mode supported (23.75 – 30.25 Hz, 47.5 – 60.5 Hz)
- Support for four digital signal inputs (DisplayPort (HDCP) × 2, HDMI (HDCP, Deep Color) × 2)
 - DisplayPort (supports 8 bit and 10 bit)^{*3,*4}
 - HDMI (supports 8 bit, 10 bit, and 12 bit)^{*3,*4}^{*3} Audio signals not supported.
^{*4} The maximum screen display is 10 bits.
- Color mode function
Reproduces a color temperature, gamma, and gamut compliant with the following standards.
 - Broadcasting standards "EBU/REC709/REC1886/REC2020/SMPTE-C"
 - Digital cinema standard "DCI"
 - Adobe® RGB / sRGB
 See "[Chapter 3 Advanced Adjustments/Settings](#)" ([page 21](#))

- This product is equipped with a built-in calibration sensor, and supports SelfCalibration in which the monitor executes calibration independently.
See [“SelfCalibration” \(page 28\)](#)
- The provided Color Management Software “ColorNavigator 6” enables you to calibrate monitor characteristics and generate color profiles
See [“1-3. EIZO LCD Utility Disk” \(page 11\)](#)
- Equipped with 4K zoom function
If a 4K2K signal (signals with a resolution of 4096 × 2160 or 3840 × 2160) is displayed on the screen, the specified area can be expanded by 2x in the display.
This is convenient when checking the fine detail of photos. This is convenient when checking the fine detail of images.
See [“2-4. Enlarging Images” \(page 19\)](#)
- Equipped with a USB Hub function that supports USB 3.0
Achieves high-speed data transfers of up to 5 Gbps, which enables transfers of large amounts of data to and from USB-connected devices in a short amount time.
Also, the “CHARGE” USB downstream port supports quick charging, so you can recharge your smartphone or tablet in a short period of time.
See [“6-4. Making Use of USB \(Universal Serial Bus\)” \(page 53\)](#) and [“USB CHARGE Port” \(page 37\)](#)
- Monitor hood is included
Includes a monitor hood that can effectively shield the monitor from the reflection of external lighting, such as the reflected glare of a fluorescent light.
- Displays HDCP (High Bandwidth Digital Protection) *5 protected contents.
*5 Supports HDCP Version 1.2



Attention

Be careful of the following points when using the built-in calibration sensor.



Do not touch the built-in calibration sensor.

It may reduce the measurement accuracy of the built-in calibration sensor, or result in injury or equipment damage.

Attention

- A high temperature or high humidity environment may affect the measurement accuracy of the built-in calibration sensor. We suggest storing and using the monitor under the following conditions.
 - Temperature 30 °C or less
 - Humidity 70% or lessAvoid storing or using the sensor where it may be exposed to direct sunlight.
- Since the measurement result for the built-in sensor may be affected, ensure that the level of ambient light that enters the receiver part of the built-in sensor does not change significantly during measuring.
 - The use of the monitor hood is recommended.
 - While measuring, do not bring your face or any objects close to the monitor, do not look into the sensor.
 - Set the monitor in the environment so that external light does not enter the sensor directly.

1-2. Controls and Functions

● Front

(Ex.CG318-4K)

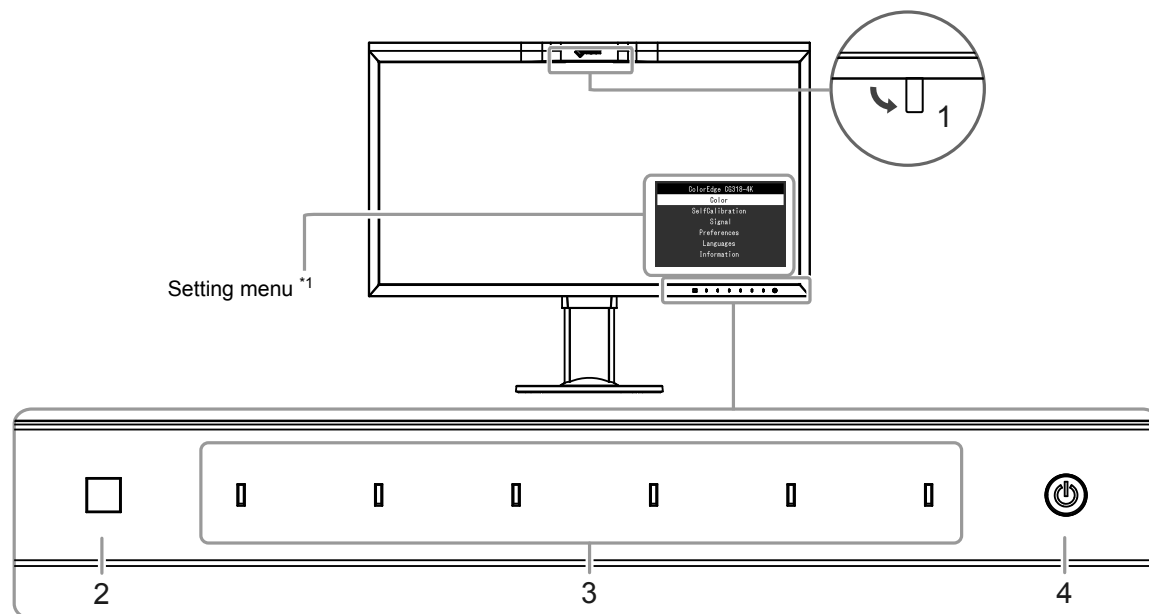

1. Built-in calibration sensor	Executes calibration for an independent monitor. SelfCalibration function (page 28)
2. Ambient light sensor	Measures ambient light.
3. Operation switches	Displays menus. Operate the switches according to the operation guide. The switch indicator is lit white when you turn the power on.
4. Power switch	Turns the power on or off. The switch indicator is lit when you turn the power on. The indicator color differs depending on the monitor's operation status. White: Operating Flashing white (quickly twice): Indicates that recalibration is required if the SelfCalibration schedule (page 39) is set. Orange: Power saving mode OFF: Main power/Power off

*1 See "3-1. Basic Operation of the Setting menu" ([page 21](#)) for how to use.

● Rear

(Ex.CG318-4K)

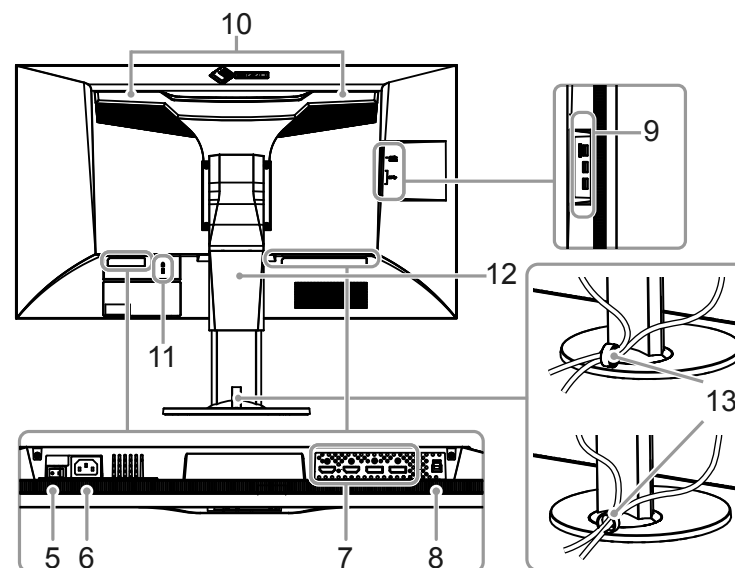

5. Main power switch	Turns the main power on or off.
6. Power connector	Connects the power cord.
7. Input signal connectors	On the monitor rear in order of left to right: HDMI connector × 2, DisplayPort connector × 2
8. USB upstream port	Connects to the USB cable when using software that requires a USB connection, or when using the USB Hub function.
9. USB downstream port	Connects to a peripheral USB device. The “CHARGE” port supports quick recharging (page 37).
10. Handle	This handle is used for transportation. Attention • Firmly grasp and hold the monitor by the bottom while grabbing the handle, and carefully convey the monitor so as not to drop it. Do not hold the sensor section on the front side of the monitor.
11. Security lock slot	Complies with Kensington’s MicroSaver security system.
12. Stand ^{*2}	Adjusts the height and angle (tilt and swivel) of the monitor.
13. Cable holder ^{*3}	Covers the monitor cables.

*2 An optional arm (or an optional stand) can be attached by removing the stand section (see “6-1. Attaching the Optional Arm” ([page 49](#))).

*3 For details on mounting the cable holder, see “6-2. Attaching/Detaching Cable Holder” ([page 50](#)).

1-3. EIZO LCD Utility Disk

An “EIZO LCD Utility Disk” (CD-ROM) is supplied with this product. The following table shows the disk contents and an overview of the software programs.

● Disk contents and software overview

The disk includes application software programs for calibration, and the User's Manual. Refer to “Readme.txt” or the “read me” file on the disk for software startup procedures or file reference procedures.

Contents	Overview
A “Readme.txt” or “read me” file	
ColorNavigator 6	An application software for measuring and calibrating monitor characteristics and generating ICC profiles (for Windows) and Apple ColorSync profiles (for Macintosh). (The monitor and PC must be connected using the USB cable.)
User's Manual of this monitor (PDF file)	

● To use ColorNavigator

Refer to the User's Manual on the CD-ROM disk in order to install and use the software. When using this software, you will need to connect a PC to the monitor with the supplied USB cable. For details of the USB cable connection, see [“6-4. Making Use of USB \(Universal Serial Bus\)” \(page 53\)](#).

Attention

- While using ColorNavigator, do not operate the power switch or operation switches on the front side on the monitor.

1-4. Supported Resolutions

The monitor supports the following resolutions.

● When using PC signal input

CG248-4K

Resolution	Vertical scan frequency	Scan Type	DisplayPort			HDMI
			Signal Format ^{*1}			
			Ver.1.2	Ver.1.1	Extra	
640 × 480	59.94 Hz	Progressive	√	√	√	√
720 × 400	70.09 Hz	Progressive	√	√	√	√
800 × 600	60.32 Hz	Progressive	√	√	√	√
1024 × 768	60.00 Hz	Progressive	√	√	√	√
1280 × 960	60.00 Hz	Progressive	√	√	√	√
1280 × 1024	60.02 Hz	Progressive	√	√	√	√
1600 × 1200	60.00 Hz	Progressive	√	√	√	√
1920 × 1080	59.96 Hz	Progressive	√	√	√	√
1920 × 1200	59.89 Hz	Progressive	√	√	√	-
1920 × 1200	59.95 Hz	Progressive	-	-	-	√
2048 × 1080	24.00 Hz / 48.00 Hz	Progressive	-	-	-	√
2560 × 1440	59.95 Hz	Progressive	-	-	-	√
3840 × 2160 ^{*2}	60.00 Hz	Progressive	√	-	√	-
3840 × 2160 ^{*2}	24.0 Hz / 29.98 Hz	Progressive	√	√	√	√
3840 × 2160 ^{*2}	24.99Hz	Progressive	√	√	√	-
3840 × 2160 ^{*2}	24.00 Hz / 25.00 Hz / 30.00 Hz	Progressive	-	-	-	√
4096 × 2160 ^{*3}	59.98 Hz	Progressive	√	-	√	-
4096 × 2160 ^{*3}	23.98 Hz / 29.97 Hz	Progressive	√	√	√	-
4096 × 2160 ^{*3}	24.00 Hz / 25.00 Hz / 30.00 Hz	Progressive	-	-	-	√

*1 The supported signal differs depending on "Signal Format" (page 43) in the "Administrator Settings" menu.

*2 Recommended resolution

*3 Select a setting other than "Dot by Dot" for "Picture Expansion" (page 32) in the Setting menu. Due to this resolution exceeding the highest resolution that can be displayed by the LCD panel, when "Dot by Dot" is used, the left and right edges of images are not displayed.

CG318-4K

Resolution	Vertical scan frequency	Scan Type	DisplayPort			HDMI
			Signal Format ^{*1}			
			Ver.1.2	Ver.1.1	Extra	
640 × 480	59.94 Hz	Progressive	√	√	√	√
720 × 400	70.09 Hz	Progressive	√	√	√	√
800 × 600	60.32 Hz	Progressive	√	√	√	√
1024 × 768	60.00 Hz	Progressive	√	√	√	√
1280 × 960	60.00 Hz	Progressive	√	√	√	√
1280 × 1024	60.02 Hz	Progressive	√	√	√	√
1600 × 1200	60.00 Hz	Progressive	√	√	√	√
1920 × 1080	59.96 Hz	Progressive	√	√	√	√
1920 × 1200	59.89 Hz	Progressive	√	-	-	-
1920 × 1200	59.95 Hz	Progressive	-	-	-	√
2048 × 1080	24.00 Hz / 48.00 Hz	Progressive	-	-	-	√
2560 × 1440	59.95 Hz	Progressive	-	-	-	√
3840 × 2160	60.00 Hz	Progressive	√	-	√	-
3840 × 2160	24.0 Hz / 30.48 Hz	Progressive	√	√	√	-
3840 × 2160	24.00 Hz / 25.00 Hz / 30.00 Hz	Progressive	-	-	-	√
4096 × 2160 ^{*2}	59.98 Hz	Progressive	√	-	√	-
4096 × 2160 ^{*2}	23.98 Hz / 29.97 Hz	Progressive	√	√	√	-
4096 × 2160 ^{*2}	24.99 Hz	Progressive	√	√	-	-
4096 × 2160 ^{*2}	48.00 Hz / 58.00 Hz	Progressive	-	-	√	-
4096 × 2160 ^{*2}	24.00 Hz / 25.00 Hz / 30.00 Hz	Progressive	-	-	-	√

*1 The supported signal differs depending on "Signal Format" (page 43) in the "Administrator Settings" menu.

*2 Recommended resolution

● When using Video signal input

CG248-4K

Resolution	Vertical scan frequency	Scan Type	HDMI
720 × 480 (480p)	60.00 Hz	Progressive	√
720 × 480 (480i)	60.00 Hz	Interlace	√
720 × 576 (576p)	50.00 Hz	Progressive	√
720 × 576 (576i)	50.00 Hz	Interlace	√
1280 × 720 (720p)	50.00 Hz / 60.00 Hz	Progressive	√
1920 × 1080 (1080p)	24.00 Hz / 25.00 Hz / 30.00 Hz / 50.00 Hz / 60.00 Hz	Progressive	√
1920 × 1080 (1080i)	50.00 Hz / 60.00 Hz	Interlace	√
3840 × 2160 *1	24.00 Hz / 25.00 Hz / 30.00 Hz	Progressive	√
4096 × 2160 *2	24.00 Hz / 25.00 Hz / 30.00 Hz	Progressive	√

*1 Recommended resolution

*2 Select a setting other than “Dot by Dot” for “Picture Expansion” ([page 32](#)) in the Setting menu. Due to this resolution exceeding the highest resolution that can be displayed by the LCD panel, when “Dot by Dot” is used, the left and right edges of images are not displayed.

CG318-4K

Resolution	Vertical scan frequency	Scan Type	HDMI
720 × 480 (480p)	60.00 Hz	Progressive	√
720 × 480 (480i)	60.00 Hz	Interlace	√
720 × 576 (576p)	50.00 Hz	Progressive	√
720 × 576 (576i)	50.00 Hz	Interlace	√
1280 × 720 (720p)	50.00 Hz / 60.00 Hz	Progressive	√
1920 × 1080 (1080p)	24.00 Hz / 25.00 Hz / 30.00 Hz / 50.00 Hz / 60.00 Hz	Progressive	√
1920 × 1080 (1080i)	50.00 Hz / 60.00 Hz	Interlace	√
3840 × 2160	24.00 Hz / 25.00 Hz / 30.00 Hz	Progressive	√
4096 × 2160 *1	24.00 Hz / 25.00 Hz / 30.00 Hz	Progressive	√

*1 Recommended resolution

1-5. Setting the Resolution

If the resolution is incorrect after connecting the monitor to a PC or if you want to change the resolution, follow the procedure below.

● Windows

1. For Windows 8.1 / Windows 8, click the “Desktop” tile on the Start Screen to display the desktop.
2. Right-click the mouse anywhere on the desktop except for icons.
3. From the displayed menu, click “Screen resolution”.
4. On the “Screen Resolution” dialog box, select the monitor.
5. Click “Resolution” to select the desired resolution.
6. Click the “OK” button.
7. When a confirmation dialog box is displayed, click “Keep changes”.

Note

- When changing the size of the characters or other items that are displayed, select “Display” from the control panel and change the scaling level.
-

● Mac OS X 10.8 or later

1. Select “System Preferences” from the Apple menu.
2. When the “System Preferences” dialog box is displayed, click “Displays”.
(If using Mac OS X 10.8, click “Displays” in “Hardware”.)
3. In the displayed dialog box, select the “Display” tab and select “Change” in the “Resolutions” field.
If the target resolution is not displayed in the list, press and hold the Option key on the keyboard and select “Scaled”.
4. Select the resolution you want to change from the list of possible resolution settings.
5. Your selection will be reflected immediately. If you are satisfied with the selected resolution, close the window.

Note

- If a suitable resolution is not displayed even after changing the resolution in the operating system, try changing the “Signal Format” ([page 43](#)) setting in the “Administrator Settings” menu.
-

Chapter 2 Basic Adjustments/Settings

This chapter describes the basic functions that can be adjusted and set by touching the switches on the front of the monitor.

For advanced adjustment and setting procedures using the Setting menu, see “[Chapter 3 Advanced Adjustments/Settings](#)” (page 21).

2-1. Switch Operation Method

1. Displaying the operation guide

1. Touch any switch (except ).



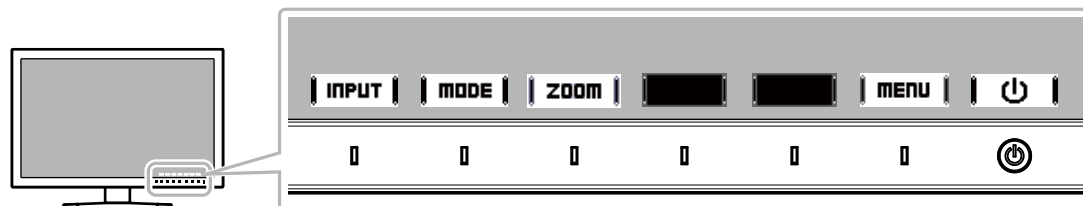

The operation guide appears on the screen.



2. Adjusting/setting

1. Touch a switch for adjustment/setting.

The Adjustment/Setting menu appears.

(A submenu may also be displayed. In that case, select an item to adjust/set with    , and then select **ENTER**.)

2. Use the switches to adjust/set the selected item, and then select **OK** to confirm.

3. Exiting

1. Select **RETURN** or **EXIT** to exit the menu.
2. When no menu is displayed, the operation guide will automatically disappear after a few seconds if no switches are operated.

Note

- The contents of the guide will differ depending on the selected menu or status.

2-2. Switching Input Signals

When a monitor has multiple signal inputs, the signal to display on-screen can be changed.

When the input signal is switched, the connector name of the displayed signal appears at the bottom right of the screen.

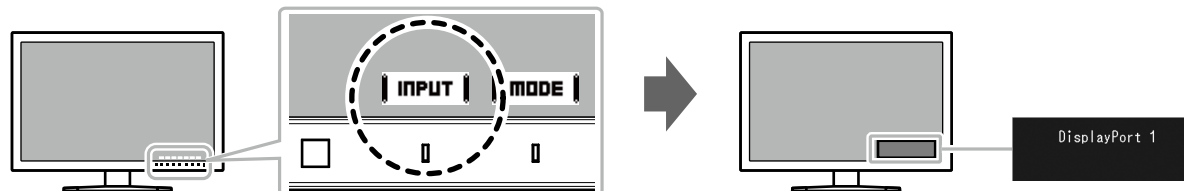

The combination of input signals that you can select differs depending on "Picture Setup" ([page 42](#)) in the "Administrator Settings" menu.

Picture Setup		Input Signal
DisplayPort	HDMI	
Single	Single	DP 1 → DP 2 → HDMI 1 → HDMI 2
Dual	Single	DP 1 DP 2 → HDMI 1 → HDMI 2
Single	Dual	DP 1 → DP 2 → HDMI 1 HDMI 2
Dual	Dual	DP 1 DP 2 → DP 1 HDMI 2 → HDMI 1 HDMI 2 → HDMI 1 DP 2

2-3. Switching the display mode (color mode)

This function allows easy selection of a display mode according to monitor application.

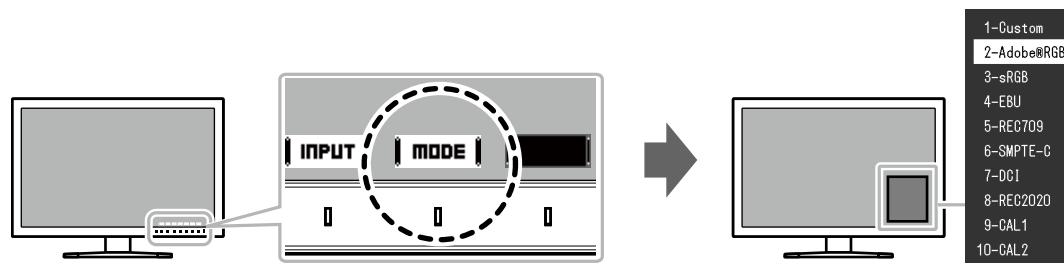

● Display Modes

Color Mode	Purpose
Standard Mode	Adjust color using the monitor's Setting menu.
Custom	Select for configuring color settings according to your preference.
Adobe®RGB	Suitable for color matching with Adobe®RGB compatible peripherals.
sRGB	Suitable for color matching with sRGB compatible peripherals.
EBU	Suitable for reproducing the color gamut and gamma as defined in the EBU (European Broadcasting Union) standards.
REC709	Suitable for reproducing the color gamut and gamma as defined in the ITU-R Rec. 709 standard.
SMPTE-C	Suitable for reproducing the color gamut and gamma as defined in the SMPTE-C standards.
DCI	Suitable for reproducing the color gamut and gamma as defined in the DCI standards.
REC2020	Suitable for reproducing the color gamut and gamma as defined in the ITU-R Rec. 2020 standard.
Calibration Mode (CAL mode)	Adjusts the monitor's color using the monitor's SelfCalibration function or the "ColorNavigator 6" color management software.
CAL1	Displays the screen adjusted by ColorNavigator and SelfCalibration.
CAL2	

Note

- The Setting menu and the Mode names cannot be displayed at the same time.
- You can disable specific mode selections. For more information, see "[Mode Skip](#)" (page 38).

2-4. Enlarging Images

If a 4K2K signal (signals with a resolution of 4096 × 2160 or 3840 × 2160) is displayed on the screen, the specified area can be expanded by 2x in the display. This is convenient when checking the fine detail of images.

Attention

- This function cannot be used when "Picture Setup" (page 42) is set to "Dual" in the "Administrator Settings" menu.

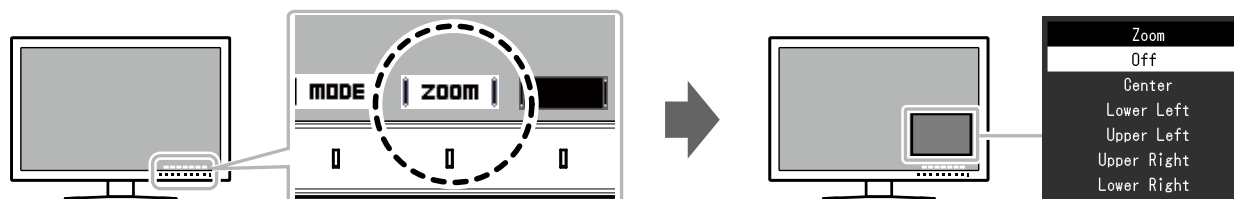

Adjustable Range

Center, Lower Left, Upper Left, Upper Right, Lower Right, Off

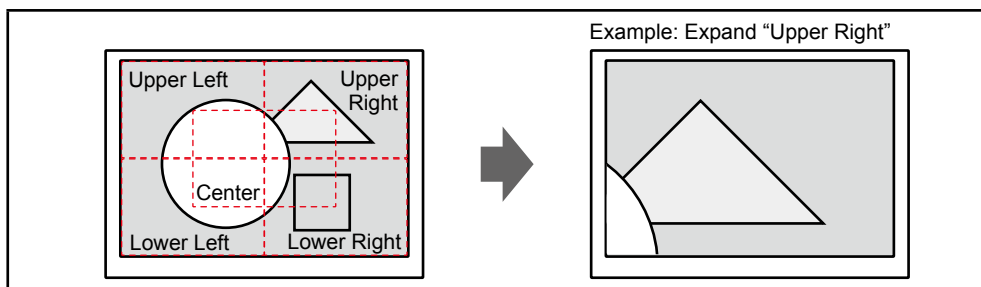

2-5. Setting the display method for colors outside the REC709 standard color gamut

*1 When inputting signals that are compliant with the REC2020 standard of ITU-R (International Telecommunication Union-Radio communication Sector), you can set the display method for colors outside the REC709 standard color gamut.

Attention

- This function can only be configured if “Color Gamut” (page 23) is set in “REC2020”.

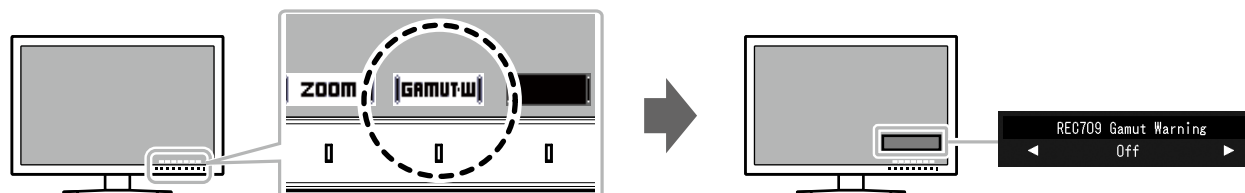

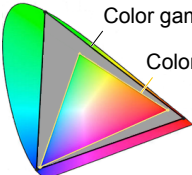
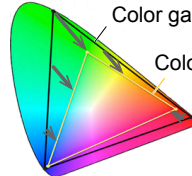
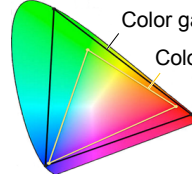
Setting	Description
On	The colors outside the REC709 color gamut are displayed in gray. 
Clip	The colors outside the REC709 color gamut are expressed within the REC709 color gamut (clipping). 
Off	The REC2020 color gamut is displayed as is. (The actual color gamut displayed on the monitor will depend on the “Clipping” setting (page 24).) 

Chapter 3 Advanced Adjustments/Settings

This chapter describes the advanced monitor adjustment and setting procedures using the Setting menu.

For the basic adjustment/setting functions using the switches on the front of the monitor, see [“Chapter 2 Basic Adjustments/Settings” \(page 16\)](#).

3-1. Basic Operation of the Setting menu

1. Menu display

1. Touch any switch (except ⏻).

The operation guide appears.

2. Select MENU .

The Setting menu appears.



2. Adjusting/setting

1. Choose a menu to adjust/set with ▲ || ▼ , and then select ENTER .

The Sub menu appears.

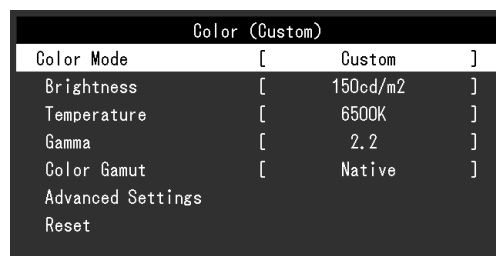

2. Choose an item to adjust/set with ▲ || ▼ , and then press ENTER .

The Adjustment/Setting menu appears.



3. Adjust/set the selected item with ◀ || ▶ , and then select OK .

The Sub menu appears.

Selecting CANCEL during adjustment/setting will cancel the adjustment/setting and restore the state prior to making changes.

3. Exiting

1. Select RETURN .

The Setting menu appears.

2. Select EXIT .

The Setting menu exits.

Note

- The contents of the guide will differ depending on the selected menu or status.

3-2. Setting Menu Functions

● Color

The setting details differ depending on the color mode selected.

When the color mode is Standard Mode (Custom / Adobe®RGB / sRGB / EBU / REC709 / SMPTE-C / DCI / REC2020)

Each color mode setting status can be adjusted according to personal preference.



Attention

- It takes about 3 minutes (under our measurement conditions) for the monitor display to stabilize. Please wait 3 minutes or more after the monitor power has been turned on, and then adjust the monitor.
- The same image may be seen in different colors on multiple monitors due to their monitor-specific characteristics. Make fine color adjustment visually when matching colors on multiple monitors.

Note

- Use the values shown in “cd/m²”, “K” and “%” as a guide only.

Function	Adjustable range	Description	Note
Color Mode	Custom Adobe®RGB sRGB EBU REC709 SMPTE-C DCI REC2020 CAL1 CAL2	Select the desired mode according to the monitor application.	<ul style="list-style-type: none"> • For more information on the adjustment status of each mode, see “2-3. Switching the display mode (color mode)” (page 18). • Regarding “CAL1 / CAL2”, see page 25.
Brightness	40 cd/m ² to 350 cd/m ²	The screen brightness is adjusted by changing the brightness of the backlight (light source from the LCD back panel).	<ul style="list-style-type: none"> • If the entered value cannot be set, the value will appear in magenta. In such a case, change the value.

Function		Adjustable range	Description	Note
Temperature		Native 4000 K to 10000 K Adobe®RGB sRGB EBU REC709 REC1886 REC2020 SMPTE-C DCI	The color temperature can be adjusted. The color temperature is normally used to express the color of “White” and/or “Black” by a numerical value. The value is expressed in degrees “K” (Kelvin). The screen becomes reddish at a low color temperature, and bluish at a high color temperature, like the flame temperature. The gain preset values are set for each color temperature setting value. Specify color temperature in units of 100 K, or select a color temperature that complies with each standard.	<ul style="list-style-type: none"> When you select “Native”, the original color of the monitor (Gain: 100% for each RGB) is displayed. “Gain” allows you to perform more advanced adjustment. When gain is changed, the color temperature is changed to “User”.
Color Gamut		Native Adobe®RGB sRGB EBU REC709 REC1886 REC2020 SMPTE-C DCI	Set the color reproduction area (color gamut). “Color gamut” is the range of colors that devices such as monitors, digital cameras and printers can express. Various standards are defined.	<ul style="list-style-type: none"> When you select “Native”, the original color gamut of the monitor is displayed. The method of displaying colors outside the monitor's color gamut can be set within the defined color gamut. For more information, see “Clipping” (page 24).
Gamma		1.6 to 2.7 Adobe®RGB sRGB EBU REC709 REC1886 REC2020 SMPTE-C DCI	Adjust the gamma. The brightness of the monitor varies depending on the input signal, however, the variation rate is not simply proportional to the input signal. The control performed to keep the balance between the input signal and the brightness of the monitor is called “Gamma correction”. You can set the gamma, or select the gamma curve defined by each standard.	-
Advanced Settings	Hue	-100 to 100	Adjust the hue.	<ul style="list-style-type: none"> Using this function may make some color gradations unavailable for display.
	Saturation	-100 to 100	Adjust the color saturation.	<ul style="list-style-type: none"> Using this function may make some color gradations unavailable for display. The minimum value (-100) changes the screen to monochrome.

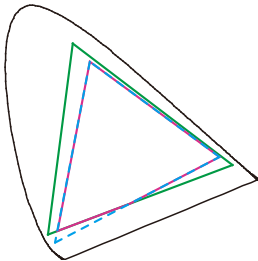
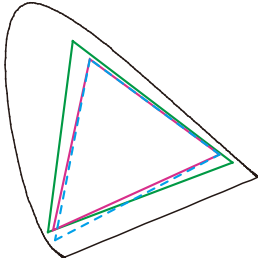
Function		Adjustable range	Description	Note
Advanced Settings	Clipping	On Off	<p>The method of displaying colors outside the monitor's color gamut can be set within the defined color gamut.</p> <ul style="list-style-type: none"> • "On" Displays colors based on the standard values. The colors outside the gamut of the monitor are clipped.  <ul style="list-style-type: none"> • "Off" Displays colors with priority on the color gradation rather than the color accuracy. The primary colors outside the gamut of the monitor (blue in the diagram) are adjusted to the colors most similar to those that can be displayed by the monitor.  <p> — Color gamut of monitor - - - Color gamut defined by standard — Color gamut displayed on screen </p>	<ul style="list-style-type: none"> • The diagrams on the left are conceptual diagrams, and do not display the actual color gamut of the monitor. • This setting will be disabled if "Native" is selected at "Color Gamut" (page 23).
	XYZ Format	On Off	When you set this function to "On", XYZ signals for Digital cinema are converted into RGB signals for display on the monitor.	<ul style="list-style-type: none"> • This function can only be configured if "Color Gamut" (page 23) is set to "DCI". • When you select "On", the "Color Gamut" setting can no longer be used.
	Gain	0% to 100%	The brightness of each color component red, green, and blue is called Gain. The hue of "white" can be changed by adjusting the gain.	<ul style="list-style-type: none"> • Using this function may make some color gradations unavailable for display. • The gain value changes according to the color temperature. • When gain is changed, the color temperature is changed to "User".
	Black Level	0% to 100%	You can adjust the brightness and chromaticity of black by adjusting the black level of red, green, and blue respectively. Please use a black test pattern or background for adjustment of the black level.	<ul style="list-style-type: none"> • To further darken the black when the value of the black level is 0, lower the brightness value.
	6 Colors	-100 to 100	The hue, saturation and lightness can each be adjusted for the colors Magenta, Red, Yellow, Green, Cyan, and Blue.	-
Reset	-	Resets any color adjustments for the currently selected color mode back to the default settings.	-	

When the color mode is Calibration Mode (CAL mode: CAL1 / CAL2)

You can set the calibration targets, and check the calibration results, for SelfCalibration.

(SelfCalibration is a function that automatically operates a calibration sensor built in to the monitor to periodically calibrate the monitor. For more information, see “SelfCalibration” (page 28).)



Function	Adjustable range	Description	Note
Color Mode	Custom Adobe®RGB sRGB EBU REC709 SMPTE-C DCI REC2020 CAL1 CAL2	Select the desired mode according to the monitor application.	<ul style="list-style-type: none"> For more information on the adjustment status of each mode, see “2-3. Switching the display mode (color mode)” (page 18). Before setting the calibration targets for SelfCalibration, select the color mode (CAL1 / CAL2) which applies the target. For information on Custom / Adobe®RGB / sRGB / EBU / REC709 / SMPTE-C / DCI / REC2020, see page 22.
SelfCalibration	On Off	Switch between enabling and disabling SelfCalibration for the currently selected color mode. After setting “On”, set a SelfCalibration target in the next “Target”.	-

Function		Adjustable range	Description	Note	
Target	Brightness	30 cd/m ² to 200 cd/m ²	Set the brightness that will be used as a calibration target for SelfCalibration.	-	
	White Point	White(x) / White(y)	0.2400 to 0.4500	Set the White Point that will be used as a calibration target for SelfCalibration.	<ul style="list-style-type: none"> When color coordinates are specified, the color temperature is changed to "User".
		Temperature	4000 K to 10000 K Adobe®RGB sRGB EBU REC709 REC1886 REC2020 SMPTE-C DCI	Set the White Point using the color coordinates (White(x) / White(y)) or color temperature. When specifying color coordinates, set the values for "White(x)" and "White(y)", respectively. When specifying the color temperature, set the color temperature in units of 100 K, or a select the color temperature that complies with each standard.	
	Color Gamut		Native Adobe®RGB sRGB EBU REC709 REC1886 REC2020 SMPTE-C DCI	Set the color gamut that will be used as a calibration target for SelfCalibration. In "Color Gamut", the color gamut defined by each standard can be selected. To set a color gamut other than those specified by each standard, specify the color coordinates of each RGB color, and the display method ("Clipping") of colors outside the monitor's color gamut at "Gamut Settings".	<ul style="list-style-type: none"> When you select "Native" in "Color Gamut", the preset color gamut of the monitor is displayed. When color coordinates are specified in the color gamut settings, the color gamut is changed to "User".
	Gamut Settings	Red(x) / Red(y) / Green(x) / Green(y) / Blue(x) / Blue(y)	0.0000 to 1.0000		
Clipping		On Off			
Gamma		1.6 to 2.7 Adobe®RGB sRGB EBU REC709 REC1886 REC2020 SMPTE-C DCI	Set the gamma that will be used as a calibration target for SelfCalibration. You can set the gamma, or select the gamma curve defined by each standard.	<ul style="list-style-type: none"> The gamma becomes "Fixed" when adjusting with ColorNavigator. 	

Function		Adjustable range	Description	Note
Result	Calibration Result	-	The previous SelfCalibration results can be checked.	-
	Ambient Light	-	You can check the current illuminance in comparison to the illuminance when SelfCalibration was previously executed.	<ul style="list-style-type: none"> This is used to check the difference between the current ambient light and the level of ambient light when SelfCalibration was executed, and is not reflected in the SelfCalibration results. If the environment in which the product is used is significantly different to the previous environment, the ambient light measurement results may vary substantially between the previous and current calibrations.
	Last Time	-	The previous SelfCalibration execution date is displayed.	-
	Usage Time	-	The monitor usage time since the previous SelfCalibration is displayed.	-
Reset		-	Resets any calibration targets for the currently selected color mode back to the default settings.	-

● SelfCalibration

This product is equipped with a built-in calibration sensor. By setting the calibration targets and execution schedule in advance, the calibration sensor automatically operates and regularly calibrates the monitor. This automatic calibration function is called “SelfCalibration”.

The adjustment content of SelfCalibration differs depending on the color mode that is executed.

- Calibration Mode (CAL mode: CAL1 / CAL2):
 - When performing SelfCalibration on the monitor itself, calibrate the monitor to match the set targets.
 - When using ColorNavigator 6, use ColorNavigator and a measurement device to maintain the calibrated state of the monitor.
- Standard Mode (color mode excluding CAL1 / CAL2): the monitor's color reproduction gamut is updated and each display mode in Standard Mode is adjusted as follows:
 - The temperature is adjusted so that it is as close as possible to the specified value.
 - The gamut values are adjusted so that they are close to each specified value.
 - Information on brightness is updated.

You can set the calibration targets and execution schedule in the monitor's Setting menu or in ColorNavigator 6.

In this section, the settings for executing SelfCalibration on the monitor as a standalone unit are explained. For the settings in ColorNavigator 6, refer to the ColorNavigator User's Manual (stored on the CD-ROM).

Attention

- It is necessary to wait at least 30 minutes after turning on the power, in order to obtain correct measurement results.

Note

- SelfCalibration can also be executed when there are no PC signals being input.
- Because the brightness and chromaticity vary as you use the monitor, it is recommended to calibrate the monitor periodically.
- The measurement results from the built-in calibration sensor can be correlated with the measurement results from the external measurement device that you want to use as a reference. For details, refer to the ColorNavigator User's Manual (stored on the CD-ROM).

Procedure

Use the following procedure to set up SelfCalibration. The steps differ according to the color mode used for executing SelfCalibration.

Calibration Mode (CAL mode)	Standard Mode
<p>1. In “Color”, set the following functions:</p> <ul style="list-style-type: none"> • “Color Mode”: Select the color mode to apply for SelfCalibration. • “SelfCalibration”: Set to “On”. • “Target”: Set a calibration target for SelfCalibration. <p>2. In “SelfCalibration”, set the following functions:</p> <ul style="list-style-type: none"> • “Settings”: Set the calibration schedule and monitor date and time for SelfCalibration. 	<p>1. In “SelfCalibration”, set the following functions:</p> <ul style="list-style-type: none"> • “Settings”: Set the calibration schedule and monitor date and time for SelfCalibration. • “Standard Mode”: Set “SelfCalibration” to “On”.



Function			Adjustable range	Description	Note
Execute			-	SelfCalibration can be executed manually regardless of the schedule.	<ul style="list-style-type: none"> After selecting “Execute”, warming up (after the power to the monitor is switched on, the monitor requires a certain period of time until the display becomes stable) may be executed before the built-in calibration sensor comes out.
Settings	Schedule	Start time	Power Save Immediately Off	Select the timing to execute SelfCalibration upon reaching the time set in the schedule. <ul style="list-style-type: none"> “Power Save” To be executed under any of the following conditions. <ul style="list-style-type: none"> - When the monitor is in “Power Save” mode or power is off at the set time. - The monitor shifts to the power saving mode or the power is turned off when the time period set in the schedule has elapsed. “Immediately” SelfCalibration is executed immediately at the set time. “Off” SelfCalibration is not executed. 	<ul style="list-style-type: none"> Upon reaching the set time, the power indicator will blink in white (quickly twice).



Function		Adjustable range	Description	Note	
Settings	Schedule	Frequency	Daily Weekly Monthly Quarterly Biannually Annually Usage Time	Select the SelfCalibration execution cycle.	-
		Timing	Jan/Apr/Jul/Oct Feb/May/Aug/Nov Mar/Jun/Sep/Dec Jan/Jul Feb/Aug Mar/Sep Apr/Oct May/Nov Jun/Dec Jan to Dec Every 50 hours to Every 500 hours	When the execution cycle is “Quarterly”, “Biannually”, “Annually”, or “Usage Time”, select the timing for executing SelfCalibration. The setting range differs depending on the execution cycle setting. <ul style="list-style-type: none"> • “Quarterly”: Jan/Apr/Jul/Oct, Feb/May/Aug/Nov, Mar/Jun/Sep/Dec • “Biannually”: Jan/Jul, Feb/Aug, Mar/Sep, Apr/Oct, May/Nov, Jun/Dec • “Annually”: Jan to Dec • “Usage Time”: Every 50 hours to Every 500 hours 	-
		Week	1st week to 5th week	When the execution cycle is “Monthly”, “Quarterly”, “Biannually”, or “Annually”, select the week for executing SelfCalibration.	<ul style="list-style-type: none"> • When no day has been selected for “Day” in the selected week, the week of execution will be as follows: - When the selected week is “1st week”: 2nd week - When the selected week is “5th week”: 4th week
		Day	Monday to Sunday	When the execution cycle is “Weekly”, “Monthly”, “Quarterly”, “Biannually”, or “Annually”, select the day for executing SelfCalibration.	-
		Time	0:00 to 23:55	When the execution cycle is “Daily”, “Weekly”, “Monthly”, “Quarterly”, “Biannually”, or “Annually”, select the time for executing SelfCalibration.	-

Function		Adjustable range	Description	Note	
Settings	Clock Adjustment	-	Set the monitor date and time.	<ul style="list-style-type: none"> When the clock has not been set, the schedule will not be applied. When ColorNavigator is started, the date and time are automatically set. For details, refer to the ColorNavigator User's Manual (stored on the CD-ROM). 	
Standard Mode	SelfCalibration	On Off	Switch between enabling/disabling the SelfCalibration function.	-	
	Result	Ambient Light	-	You can check the current illuminance in comparison to the illuminance when SelfCalibration was previously executed.	-
		Last Time	-	The previous SelfCalibration execution date is displayed.	-
		Usage Time	-	The monitor usage time since the previous SelfCalibration is displayed.	-

● Signal Settings

The signal settings are used to configure advanced settings for input signals, such as the screen display size and color format.

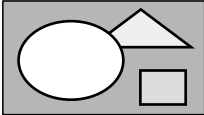
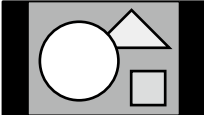

Function	Input Signal (The setting range of each function differs depending on the input signal.) √: Settable -: Not settable			Adjustable range	Description	Note
	DisplayPort	HDMI				
		PC signal	Video signal			
Picture Expansion	√	√	-	Full Screen Aspect Ratio Dot by Dot	<p>The screen size of the monitor display can be changed.</p> <ul style="list-style-type: none"> “Auto” The monitor automatically changes the screen size according to the resolution information and aspect ratio information sent from the input signal. “Full Screen” Displays an image in full screen. Images are distorted in some cases because the vertical rate is not equal to the horizontal rate. When using video signal (480p/i, 576p/i) input, the image will be displayed in full screen while maintaining the 16:9 aspect ratio. “Aspect Ratio” Displays an image in full screen. However, since aspect ratios are maintained, part of an image may not be visible in horizontal or vertical direction. When using video signal (480p/i, 576p/i) input, the image will be displayed in full screen while maintaining the 4:3 aspect ratio. “Dot by Dot” Displays the image at the set resolution or at the size specified by the input signal. 	<ul style="list-style-type: none"> • Example settings <ul style="list-style-type: none"> - Full Screen  - Aspect Ratio  - Dot by Dot (input signal)  • When “Dot by Dot” is selected during 4096 x 2160 signal input for the CG248-4K, this exceeds the highest resolution that can be displayed by the LCD panel, so the left and right edges of images cannot be displayed.
	-	-	√	Auto Full Screen Aspect Ratio Dot by Dot		

Function		Input Signal (The setting range of each function differs depending on the input signal.) √: Settable -: Not settable			Adjustable range	Description	Note
		DisplayPort	HDMI				
			PC signal	Video signal			
Input Color Format		√	-	-	Auto YUV RGB	The color format of the input signal can be specified. Try changing this setting if colors are not displayed correctly.	<ul style="list-style-type: none"> This setting is required when a DVI device is connected to the monitor via the HDMI connector port using a DVI-HDMI conversion connector.
		-	√	-	YUV 4:2:2 YUV 4:4:4 RGB		
		-	-	√	Auto YUV RGB		
Range Extension	Range Extension	√	-	√	Auto On Off	Depending on the external device, the black and white levels in the video signal output to the monitor may be restricted. If the signal is displayed on the monitor in its restricted form, the blacks will be faint, the whites dull, and contrast will be reduced. The brightness range of such signals can be extended to match the actual contrast ratio of the monitor.	<ul style="list-style-type: none"> Example settings <ul style="list-style-type: none"> - On
		-	√	-	On Off		
							<ul style="list-style-type: none"> - Off
							<ul style="list-style-type: none"> If “Range Extension” is set to “On” while an unlimited signal is displayed, black to white gradation may be lost.

Function		Input Signal (The setting range of each function differs depending on the input signal.) √: Settable -: Not settable			Adjustable range	Description	Note
		DisplayPort	HDMI				
			PC signal	Video signal			
Range Extension	Super White	√	√	√	On Off	The method for extending signals can be selected by turning the “Super white” setting “On” or “Off”. <ul style="list-style-type: none"> • “On” The brightness range of the input signal is extended from 16 – 254 to 0 – 255 for display. • “Off” (Default setting) The brightness range of the input signal is extended from 16 – 235 to 0 – 255 for display. 	<ul style="list-style-type: none"> • If “Range Extension” is turned “Off”, the setting can be changed but the change will not be applied.
HDMI Settings	Noise Reduction	-	√	√	On Off	The small noises that occur in dark areas of an image are reduced. Use this function to reduce noise and roughness in images.	<ul style="list-style-type: none"> • Using the Noise Reduction function may lead to deterioration of fine images. • When the “Picture Setup” (page 42) setting in the “Administrator Settings” menu is set to “Dual”, this function will not operate.
	Film Detection	-	√	√	On Off	The display method can be selected before the interlace signal is displayed. Signals of 24 frames or 30 frames per second for images such as movies, computer graphics, and animations are automatically identified and the most suitable images are displayed.	<ul style="list-style-type: none"> • If distorted images are displayed when “Film Detection” is “On”, set it to “Off”. • “Film Detection” is only enabled during 1080i signal input.

Function		Input Signal (The setting range of each function differs depending on the input signal.) √: Settable -: Not settable			Adjustable range	Description	Note
		DisplayPort	HDMI				
			PC signal	Video signal			
HDMI Settings	Safe Area Marker	-	√	√	On Off	The “safe area” is an area in which images can be displayed on any display device. When you set this function to “On”, this function displays the safe area frame during for instance video editing, to enable positioning while confirming at a glance that subtitles and menu windows come within the safe area.	<ul style="list-style-type: none"> When the “Picture Setup” (page 42) setting in the “Administrator Settings” menu is set to “Dual”, the safe area frame is displayed only when both the left and right screens are the same resolution. When displaying the 4096 x 2160 signal on the CG248-4K, vertical lines may not be displayed in the safe area frame if “Dot by Dot” is set for “Picture Expansion” (page 32) in the Setting menu.
	Safe Area Size	-	√	√	80% to 99%	The size of the safe area can be set.	-
	Border Color	-	√	√	White Red Green Blue Cyan Magenta Yellow	The color of the safe area frame can be set.	-

● Preferences

The monitor's settings can be configured to suit the usage environment or personal preference.

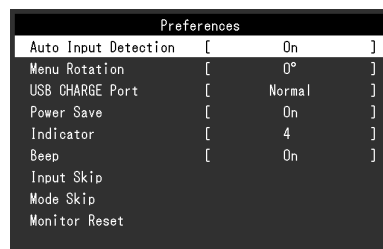

Function	Adjustable range	Description	Note
Auto Input Detection	On Off	<p>When this function is set to "On", the monitor automatically recognizes the connector through which signals are input, so that the screen can be displayed. When an external device enters the power saving mode, the monitor automatically displays another signal.</p> <p>When set to "Off", the monitor displays the signal from the selected connector regardless of whether a signal is input or not. In this case, select the input signal to display using the operation switch (INPUT) on the front of the monitor.</p>	<ul style="list-style-type: none"> When the main power is turned on/off, the signal is detected automatically regardless of the setting for this function. When the "Picture Setup" (page 42) setting in the "Administrator Settings" menu is set to "Dual", we recommend that this function be set to "Off". If "Dual" is set, automatic detection stops as soon as the signal of either screen is detected, and only one screen will be displayed.

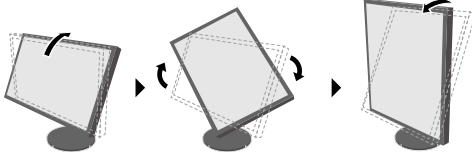
Function	Adjustable range	Description	Note
Menu Rotation	0° 90°	This function allows you to change the orientation of the Setting menu to align with the installation orientation.	<ul style="list-style-type: none"> • Be sure that the cables are correctly connected. • When using the monitor screen in a portrait position, the graphics board supporting portrait display is required. When placing the monitor in a portrait position, settings of your graphics board need to be changed. Refer to the User's Manual of the graphics board for details. Also, visit the EIZO website (http://www.eizoglobal.com). • When using the CG248-4K in a portrait position, rotate the monitor after pulling up the screen to the uppermost position of the stand and setting the screen tilted upward.  <ul style="list-style-type: none"> • When using the CG318-4K in a portrait position, you need to replace the stand with an arm.
USB CHARGE Port	Normal Charging Only	The "CHARGE" USB downstream port of the monitor supports USB 3.0 quick charging. By changing this setting to "Charging Only", devices connected to the "CHARGE" port can be charged more quickly than when using the "Normal" setting.	<ul style="list-style-type: none"> • Make sure to complete any communication between connected USB devices and the PC before switching this setting. When the setting is switched, all communication will be temporarily interrupted. • Devices that are connected to the "CHARGE" port must support quick charging. • When "Charging Only" is set, data communications between the PC and connected devices via the "CHARGE" port are not possible, and therefore, connected devices will not work. • When "Charging Only" is set, charging is possible even when the monitor and PC are not connected by USB cable.

Function	Adjustable range	Description	Note
Power Save	On Off	<p>This function allows you to set the monitor to the power saving mode, depending on the state of an external device connected to it.</p> <p>The monitor changes to power saving mode about 15 seconds after signal input ceases to be detected. When the monitor has shifted to power saving mode, images are not displayed on the screen.</p> <ul style="list-style-type: none"> Exiting power saving mode <ul style="list-style-type: none"> If the monitor receives input, it automatically exits power saving mode and returns to the normal display mode. 	<ul style="list-style-type: none"> At the time of shifting to power saving mode, a message that indicates the transition is displayed 5 seconds in advance. Turning off the main power switch or unplugging the power cord completely shuts off power supply to the monitor. When the monitor is in power saving mode, devices connected to the USB downstream port will still work. Therefore, power consumption of the monitor varies even in the power saving mode, depending on the connected devices.
Indicator	Off / 1 to 7	The brightness of the power switch and the operation switches when the screen is displayed can be set. (Default setting: 4)	-
Beep	On Off	You can turn off the beep that sounds each time a switch is operated.	-
Input Skip	Skip / -	This function allows skipping of input signals that will not be used when the input signals are switched.	<ul style="list-style-type: none"> Set at least one mode to "-".
Mode Skip	Skip / -	This function allows skipping of modes that will not be used when selecting modes. Please use this function if display modes are limited, or if you want to prevent randomly changing the display status.	<ul style="list-style-type: none"> Not all modes can be set to "Skip". In the default settings, available calibration modes (CAL modes) differ depending on each input signal.
Monitor Reset	-	<p>Restore all settings to their default values except for the following settings.</p> <ul style="list-style-type: none"> Settings in the "Administrator Settings" menu The "Settings" – "Clock Adjustment" item in the "SelfCalibration" menu 	<ul style="list-style-type: none"> Regarding the default setting, see "Main Default Settings" (page 62).

● Languages

The display language for menus and messages can be selected.

Adjustable range

English, Deutsch, Français, Español, Italiano, Svenska, Japanese, Simplified Chinese, Traditional Chinese



● Information

You can check the monitor information (model name, serial number, firmware version, usage time, ColorNavigator license status, resolution, input signal, etc.).

Example:

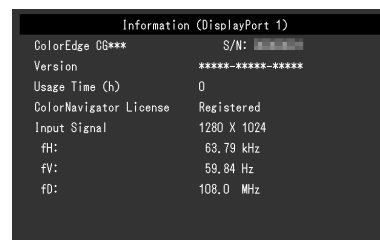



Chapter 4 Administrator Settings

This chapter describes how to configure monitor operation using the “Administrator Settings” menu.

This menu is for administrators. Configuration on this menu is not required for normal monitor use.

4-1. Basic Operation of the “Administrator Settings” menu

1. Menu display

1. Touch  to turn off the monitor.
2. While touching the leftmost switch, touch  for more than 2 seconds to turn on the monitor.

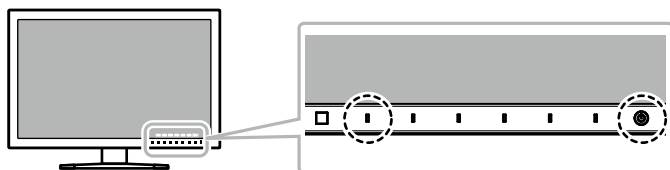

The “Administrator Settings” menu appears.



2. Settings

1. Choose an item to set with  , and then select .
- The Adjustment/Setting menu appears.

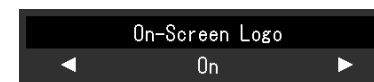

2. Set the item with  , and then select .
- The “Administrator Settings” menu appears.

3. Applying and exiting

1. Select “Apply”, and then select .
- The settings are confirmed and the “Administrator Settings” menu quits.

4-2. “Administrator Settings” Menu Functions

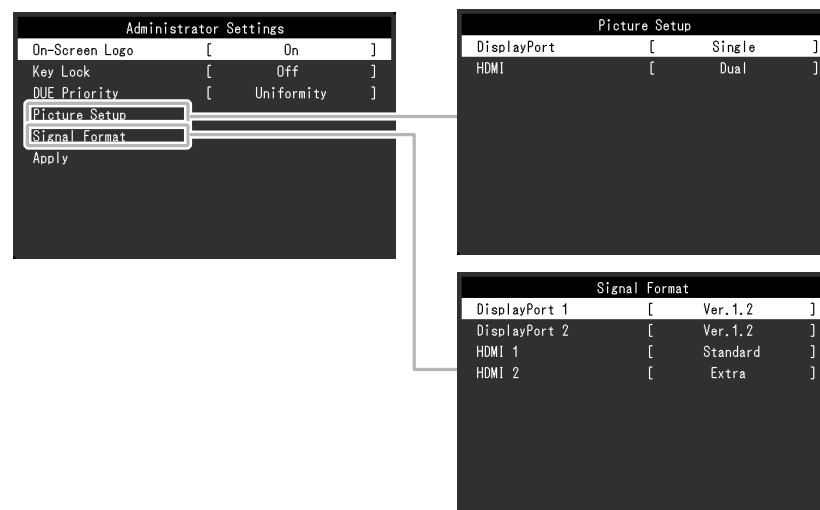

Function	Adjustable Range	Description	Note
On-Screen Logo	On Off	When the monitor is turned on, the EIZO logo appears on the screen. When this function is set to “Off”, the EIZO logo does not appear.	-
Key Lock	Off Menu All	In order to prevent changes to settings, the operation switches on the front of the monitor can be locked. <ul style="list-style-type: none"> • “Off” (Default setting) Enable all switches. • “Menu” Lock the MENU switch. • “All” Lock all switches except the power switch. 	-
DUE Priority	Brightness Uniformity	This product is equipped with a Digital Uniformity Equalizer (DUE) function that reduces display unevenness. This DUE setting can be changed. <ul style="list-style-type: none"> • “Brightness” Prioritizes high brightness and high contrast. • “Uniformity” Prioritizes reduction of display unevenness. 	<ul style="list-style-type: none"> • When changing the DUE setting, the monitor whose display is adjusted must be re-calibrated. Perform the target calibration and correlation again using ColorNavigator. For details, refer to the ColorNavigator User's Manual (stored on the CD-ROM).

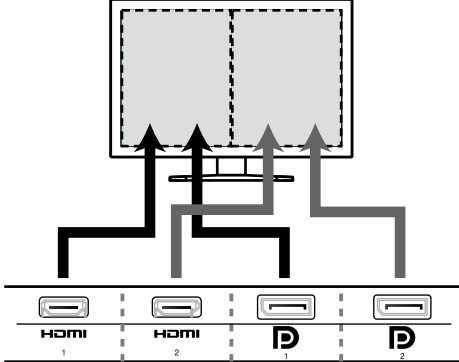



Function	Adjustable Range	Description	Note
Picture Setup	DisplayPort	Single Dual	<ul style="list-style-type: none"> When using “Dual” display, the signal input from DisplayPort 1 or HDMI 1 is displayed on the left side of the screen, and the signal input from DisplayPort 2 or HDMI 2 is displayed on the right side of the screen.  <ul style="list-style-type: none"> The supported resolutions when using “Dual” are as follows. <ul style="list-style-type: none"> When using PC signal input 640 × 480 / 720 × 400 / 800 × 600 / 1024 × 768 / 1280 × 960 / 1280 × 1024 / 1600 × 1200 / 1920 × 1080 / 1920 × 1200^{*1} / 1920 × 2160 / 2048 × 2160^{*2} *1 DisplayPort input only (CG248-4K) , DisplayPort Ver.1.2 input only (CG318-4K) *2 CG318-4K only When using Video signal input 720 × 480 (480p/i) / 720 × 576 (576p/i) / 1280 × 720 (720p) / 1920 × 1080 (1080p/i) When using “Dual” display, the connector settings of the screen on the left, such as the color settings, will be applied.
	HDMI	Single Dual	

Function		Adjustable Range	Description	Note
Signal Format	DisplayPort 1 DisplayPort 2	Ver.1.2 Ver.1.1 Extra	When a PC is connected via the DisplayPort connector, the DisplayPort version may differ depending on the PC, and the screen may not be displayed. In this case, try changing the following settings.	-
	HDMI 1 HDMI 2	Standard Extra	When an external device is connected via the HDMI connector, the 4096 × 2160 resolution may not be displayed depending on the device. In this case, try changing the following settings.	-

Chapter 5 Troubleshooting

If a problem still remains after applying the suggested remedies, contact your local EIZO representative.

5-1. No picture

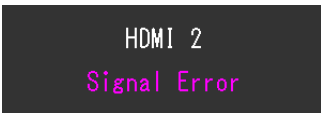
Problem	Possible cause and remedy
<p>1. No picture</p> <ul style="list-style-type: none"> Power indicator does not light up. <hr/> <ul style="list-style-type: none"> Power indicator is lighting white. Power indicator is lighting orange. <hr/> <ul style="list-style-type: none"> Power indicator is flashing orange and white. 	<ul style="list-style-type: none"> Check whether the power cord is connected properly. Turn the main power switch on. Touch . Turn off the main power, and then turn it on again a few minutes later. <hr/> <ul style="list-style-type: none"> Increase “Brightness” and/or “Gain” in the Setting menu. (See “Color” (page 22)) <hr/> <ul style="list-style-type: none"> Switch the input signal. Move the mouse or press any key on the keyboard. Check whether the PC is turned on. If the computer is connected to the DisplayPort, use the following procedure to switch the DisplayPort version. <ol style="list-style-type: none"> Touch  to turn off the monitor. While touching the leftmost switch, touch  for more than 2 seconds to turn on the monitor. The “Administrator Settings” menu appears. Select “Signal Format”. Change the DisplayPort version to 1.1. Select “Apply”, and then select ENTER. <hr/> <ul style="list-style-type: none"> The device that is connected using DisplayPort / HDMI has a problem. Resolve the problem, turn off the monitor, and then turn it on again. Refer to the User’s Manual of the output device for further details.
<p>2. The message below appears.</p> <ul style="list-style-type: none"> This message appears when no signal is input. Example:  The message shows that the input signal is out of the specified frequency range. Example:  	<p>This message appears when the signal is not input correctly even though the monitor is functioning properly.</p> <hr/> <ul style="list-style-type: none"> The message shown left may appear, because some PCs do not output the signal immediately after power-on. Check whether the PC is turned on. Check whether the signal cable is connected properly. Switch the input signal. <hr/> <ul style="list-style-type: none"> Check whether the PC is configured to meet the resolution and vertical scan frequency requirements of the monitor (see “1-3. EIZO LCD Utility Disk” (page 11)). Reboot the PC. Change to the appropriate setting using the graphics board’s utility. Refer to the User’s Manual of the graphics board for details.

5-2. Imaging problems

Problem	Possible cause and remedy
1. The screen is too bright or too dark.	<ul style="list-style-type: none"> Use “Brightness” in the Setting menu to adjust it. (see “Color” (page 22)). (The LCD monitor backlight has a limited life span. When the screen becomes dark or begins to flicker, contact your local EIZO representative.)
2. Afterimages appear	<ul style="list-style-type: none"> Afterimages are particular to LCD monitors. Avoid displaying the same image for a long time. Use the screen saver or power saving function to avoid displaying the same image for extended periods of time.
3. Green/red/blue/white dots or defective dots remain on the screen.	<ul style="list-style-type: none"> This is due to LCD panel characteristics and not a malfunction.
4. Interference patterns or pressure marks remain on the screen.	<ul style="list-style-type: none"> Display a white or black image over the entire screen. The symptom may disappear.
5. Noise appears on the screen.	<ul style="list-style-type: none"> When inputting HDCP system signals, normal images may not be displayed immediately. Depending on the graphics board, the 4K2K (3840 x 2160/4096 x 2160) signal may not be output normally, and noise may appear. Check the graphics board specification.
6. The color shown on the screen is not correct.	<ul style="list-style-type: none"> Try changing “Input Color Format” in the Setting menu (see “Input Color Format” (page 33)). For HDMI signal input, try changing “Signal Format” in the Setting menu (see “Signal Format” (page 43)).
7. The image does not display on the entire screen.	<ul style="list-style-type: none"> Try changing “Picture Expansion” in the Setting menu (see “Picture Expansion” (page 32)). Try changing “Signal Format” in the Setting menu (see “Signal Format” (page 43)). Check if the resolution is set to the recommended setting (CG248-4K: 3840×2160/ CG318-4K:4096×2160). Refer to the User's Manual of the graphics board for details on the settings. Depending on the graphics board, the 4K2K (3840 x 2160/4096 x 2160) resolution may not be output. Check the graphics board specification. If the image is only displayed on half of the screen, check if the “Picture Setup” (page 42) setting in the “Administrator Settings” menu is set to “Dual”.

5-3. Other problems

Problem	Possible cause and remedy
1. The Setting menu/Mode menu cannot be displayed	<ul style="list-style-type: none"> • Check whether the operation switch lock function works (see “Key Lock” (page 41)). • Operation switches are locked when ColorNavigator is running. Exit the software.
2. The monitor connected with the USB cable is not detected. / USB device connected to the monitor does not work.	<ul style="list-style-type: none"> • Check whether the USB cable is connected correctly (see “6-4. Making Use of USB (Universal Serial Bus)” (page 53)). • If a peripheral device is connected to the “CHARGE” port, try checking the “USB CHARGE Port” setting (see “USB CHARGE Port” (page 37)). If it is set to “Charging Only”, the peripheral device will not work. • Try changing to a different USB port. If the PC or peripheral devices works correctly by changing the USB port, contact your local EIZO representative. (Refer to the manual of the PC for details.) • Reboot the PC. • If the peripheral devices work correctly when the PC and peripheral devices are connected directly, contact your local EIZO representative. • Check whether the PC and OS are USB compliant. (For USB compliance of the respective devices, consult their manufacturers.) • Depending on the USB 3.0 host controller that you are using, connected USB devices may not be recognized correctly. Update to the latest USB 3.0 driver provided by each manufacturer, or connect the monitor to the USB 2.0 port. • Check the PC’s BIOS setting for USB when using Windows. (Refer to the manual of the PC for details.)
3. Audio is not output.	<ul style="list-style-type: none"> • This monitor does not support the HDMI/DisplayPort audio signals.

5-4. Built-in calibration sensor and SelfCalibration problems

Problem	Possible cause and remedy
1. The built-in calibration sensor does not come out/stays out.	<ul style="list-style-type: none"> • Turn off the main power, and then turn it on again a few minutes later.
2. SelfCalibration cannot be executed.	<ul style="list-style-type: none"> • Check whether the date and time are set correctly on the monitor (see “Clock Adjustment” (page 31)). • Check whether the execution schedule been set (see “Schedule” (page 29)). • Check whether the calibration targets are set correctly (see “Target” (page 26)). • Set the SelfCalibration target using ColorNavigator.
3. SelfCalibration failure	<ul style="list-style-type: none"> • Refer to the error code table. If an error code that does not appear in the error code table is displayed, contact your local EIZO representative.

Error Code Table

Error Code	Description
0011	<ul style="list-style-type: none"> • Calibration cannot be performed because the target brightness is too low. Change the target value, and execute SelfCalibration again.
0013	<ul style="list-style-type: none"> • Light may have entered the built-in calibration sensor during measurement. Ensure that light does not enter the sensor, and then execute SelfCalibration again. The built-in calibration sensor may not have worked correctly. Try executing correlation using ColorNavigator.
0014	<ul style="list-style-type: none"> • The target brightness may be too high. Change the target value, and then execute SelfCalibration again. • The measurement accuracy of the built-in calibration sensor may be low. Try executing correlation using ColorNavigator. • Adjust using ColorNavigator.
0030 0032 0041	<ul style="list-style-type: none"> • Communication with the built-in calibration sensor failed. Turn off the main power, wait for a few minutes before turning the power back on, and then execute SelfCalibration again.
0033	<ul style="list-style-type: none"> • The built-in calibration sensor may not have worked correctly. Turn off the main power, wait for a few minutes before turning the power back on, and then execute SelfCalibration again.
0034	<ul style="list-style-type: none"> • The built-in calibration sensor may not have come out during calibration, or external light may have entered the sensor during measurement. Turn off the main power, wait for a few minutes before turning the power back on, and then execute SelfCalibration again.
0036	<ul style="list-style-type: none"> • SelfCalibration may not have worked correctly. Check the target value, and then execute SelfCalibration again.
0037	<ul style="list-style-type: none"> • The built-in calibration sensor may not have worked correctly. Try executing correlation using ColorNavigator.
0038 0039 0040	<ul style="list-style-type: none"> • The built-in calibration sensor may not have worked correctly. Turn off the main power, wait for a few minutes before turning the power back on, and then execute SelfCalibration again.

Error Code	Description
0050	<ul style="list-style-type: none">Failed to initialize the built-in calibration sensor. External light may have entered the built-in calibration sensor. Ensure that light does not enter the sensor, and then execute SelfCalibration again.Communication with the built-in calibration sensor may have failed. Turn off the main power, wait for a few minutes before turning the power back on, and then execute SelfCalibration again.
0060 0061	<ul style="list-style-type: none">The built-in calibration sensor may not have worked correctly.Check whether there is any foreign object near the built-in calibration sensor.Execute SelfCalibration again.

Chapter 6 Reference

6-1. Attaching the Optional Arm

An optional arm (or an optional stand) can be attached by removing the stand section. Please refer to our web site for the corresponding optional arm (or optional stand). <http://www.eizoglobal.com>

Attention

- When attaching an arm or stand, follow the instructions of their User's Manual.
- When using another manufacturer's arm or stand, confirm the following in advance and select one conforming to the VESA standard. Use the screws securing the unit and the stand.
 - Clearance between screw holes: 100 mm × 100 mm
 - Plate thickness: 2.6 mm
 - Must be strong enough to support weight of the monitor unit (excluding the stand) and attachments such as cables.
- When using an arm or stand, attach it to meet the following tilt angles of the monitor.
 - Up 45°, down 45°
- Connect the cables after attaching an arm or stand.
- Do not move the removed stand up and down. Doing so may result in injury or equipment damage.
- The monitor, arm, and stand are heavy. Dropping them may result in injury or equipment damage.
- When installing the monitor in portrait mode, turn the monitor screen 90° in clockwise direction.

Attachment procedure

1. To prevent damaging the panel surface, lay the LCD monitor on a soft cloth spread on a stable surface with the panel surface facing down.

2. Remove the stand.

Prepare a screwdriver.

Using a screwdriver, remove the screws (four) securing the unit and the stand.

3. Attach the arm or stand to the monitor.

Secure the monitor to the arm or stand using the screws specified in the User's Manual of the arm or stand.

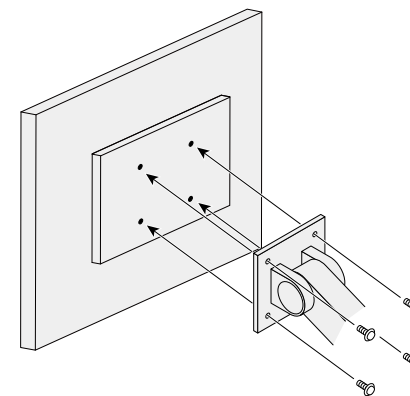

6-2. Attaching/Detaching Cable Holder

A cable holder is supplied with this product. Use the cable holder to organize the cables connected to the monitor.

Attachment procedure

1. Pass the cables through the cable holder.
2. Close the cable holder.

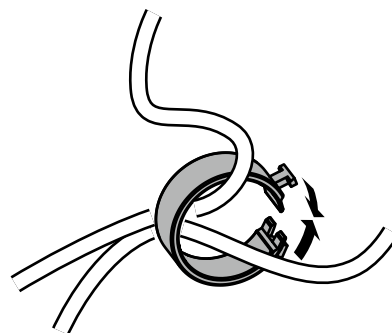

3. While holding the cable holder closed, insert it into the stand.

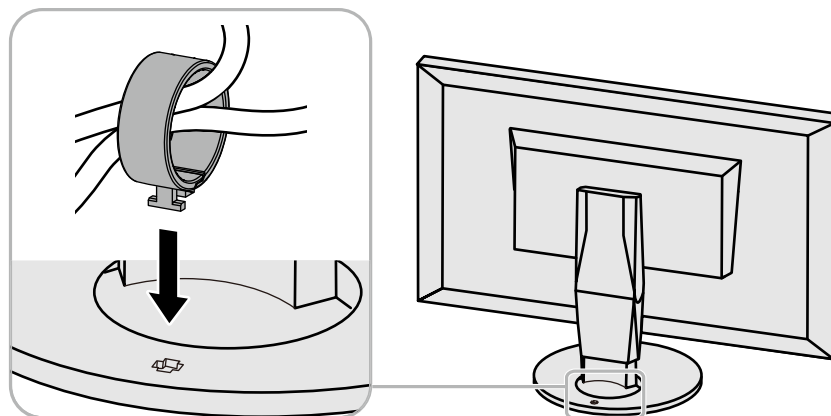

Note

- The cable holder can be inserted either perpendicular or parallel to the stand. Change the orientation of the cable holder in line with the direction of the cables.

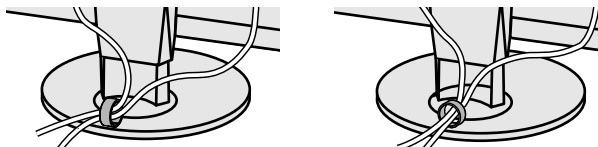
**Detachment procedure**

- 1. Close the cable holder.**
- 2. While holding the cable holder closed, pull it from the stand.**

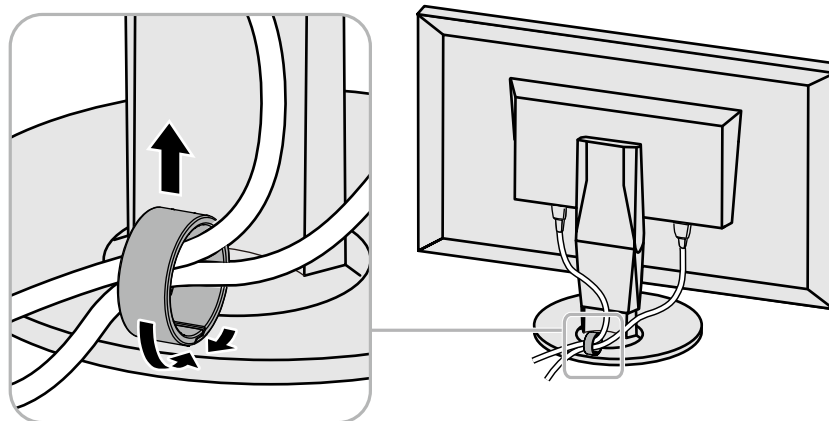

6-3. Connecting Multiple External Devices

The product allows you to connect multiple external devices and switch between them for display.

Connection examples

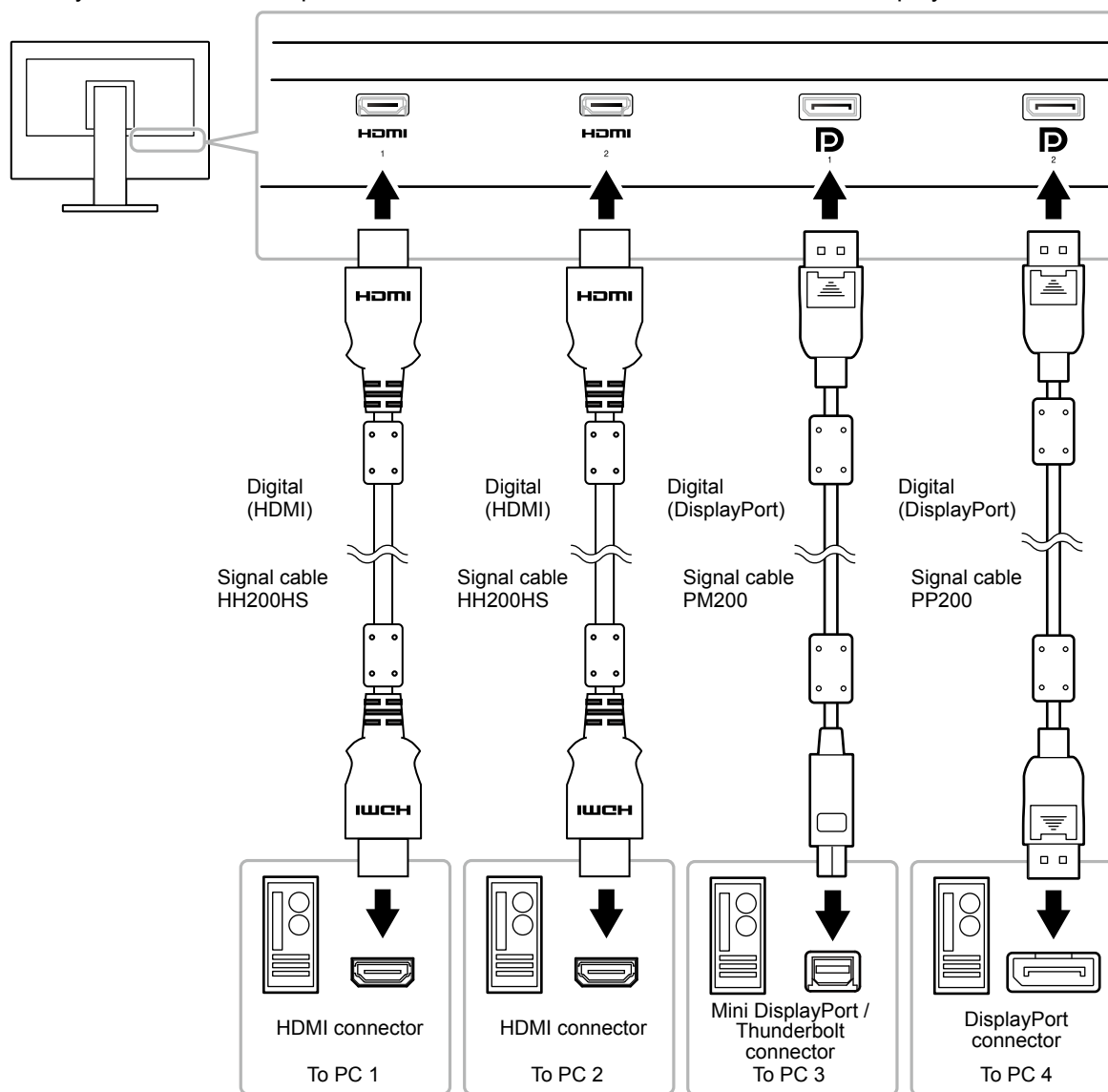

Note

- The input signal changes each time the operation switch (**INPUT**) on the front of the monitor is touched. When the signal is switched, the active input connector name appears at the lower right corner of the screen.
- This product automatically recognizes the connector through which signals are input and displays images on the screen accordingly. For more information, see [“Auto Input Detection” \(page 36\)](#).

6-4. Making Use of USB (Universal Serial Bus)

This monitor is equipped with a USB hub. It works as a USB hub when connected to a USB-compatible PC, allowing the connection of peripheral USB devices.

Note

- This product supports USB 3.0. When connecting peripheral devices that support USB 3.0, high-speed data communication is possible (however, only when the USB cable used to connect the PC and peripheral device is USB 3.0 compliant).
- The “CHARGE” USB downstream port also supports quick charging. This allows you to recharge your smartphone or tablet in a short period of time. (See “USB CHARGE Port” (page 37).)

● Required System Environment

- A PC equipped with a USB port
- Windows 8.1 / Windows 8 / Windows 7, or Mac OS X 10.7.5 or later
- EIZO USB cable (UU200SS (USB 3.0))

Attention

- This monitor may not work depending on the used PC, OS or peripheral devices. For USB compatibility of peripheral devices, contact their manufactures.
- When the monitor is in power saving mode, devices connected to the USB downstream port will still work. Therefore, power consumption of the monitor varies depending on the connected devices, even in the power saving mode.
- When the main power of the monitor is off, a device connected to the USB downstream port will not operate.
- When the “USB CHARGE Port” setting in “Preferences” is set to “Charging Only”, a peripheral device will not work if connected to the “CHARGE” port.
- Ensure that communication between all peripheral devices connected to the monitor and the PC is ended before switching the “USB CHARGE Port” setting. When the setting is switched, all communication will be temporarily interrupted.

● Connection Procedure (Setup of USB Function)

1. Connect the monitor first to a PC using the signal cable, and start the PC.
2. Connect the USB cable between the USB downstream port of the PC and the USB upstream port of the monitor.
The USB hub function is set up automatically upon connection of the USB cable.
3. Connect the peripheral USB device to the USB downstream port of the monitor.

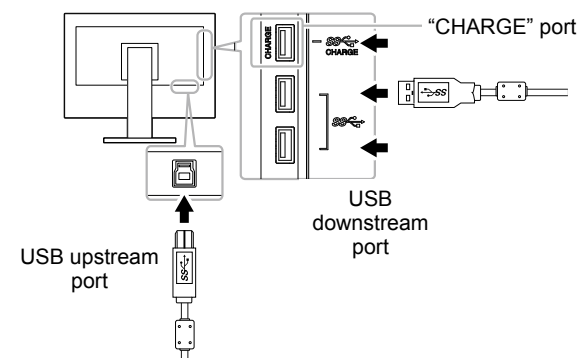

6-5. Specifications

CG248-4K

LCD Panel	Type	IPS (Anti-Glare)
	Backlight	Wide color gamut LED
	Size	60 cm (23.8 inch) (60.4 cm diagonal)
	Resolution	3840 dots × 2160 lines
	Display Size (H × V)	527.04 mm × 296.46 mm
	Pixel Pitch	0.13725 mm
	Pixel Density	185 ppi
	Display Colors	Approx. 1073.74 million colors (for 10 bit input)
	Viewing Angle (H / V, typical)	178° / 178°
	Recommended Brightness (typical)	120 cd/m ² or less (Temperature: 5000 K to 6500 K)
	Contrast Ratio (typical)	1000 : 1 (When “DUE Priority” setting is “Brightness”)
	Response Time (typical)	Black-white-black: 14 ms Gray-to-gray: 14 ms
	Color Gamut Display (typical)	Adobe® RGB coverage: 99%, DCI-P3 coverage: 93%
Video Signals	Input Terminals	DisplayPort 1.2 (HDCP 1.2-compatible) × 2, HDMI (HDCP 1.2, Deep Color-compatible) *1 × 2
	Digital Scanning Frequency (H / V)	24.5 kHz to 137.5 kHz (DisplayPort), 14.5 kHz to 135.5 kHz (HDMI) / 22.5 Hz to 71.5 Hz (DisplayPort), 22.5 Hz to 71.5 Hz (HDMI)
	Frame Synchronization Mode	23.75 Hz to 30.25 Hz, 47.5 Hz to 60.5 Hz
	Dot clock (Max.)	598.3 MHz (DisplayPort), 300 MHz (HDMI)
USB	Port	Upstream port × 1, downstream port × 3 (The “CHARGE” port supports quick recharging)
	Standard	USB Specification Rev. 3.0 USB Battery Charging Specification Rev.1.2
	Communication Speed	5 Gbps (super), 480 Mbps (high), 12 Mbps (full), 1.5 Mbps (low)
	Supply Current	Downstream: Max. 900 mA per port Downstream (CHARGE Port): Normal: Max. 1.5 A per port, Charging Only: Max. 2.1 A per port
Power	Input	100–240 VAC ±10%, 50/60 Hz 1.45 A–0.75 A)
	Maximum Power Consumption	136 W or less
	Power Save Mode	9.0 W or less (no signal is input when there is no USB device connected)
	Standby Mode	9.0 W or less (no signal is input when there is no USB device connected)

*1 HDMI CEC (mutual control) is not supported.

Physical Specifications	Dimensions	Min. height: 553 mm × 394 mm × 245 mm (W × H × D) (Tilt: 0°) Max. height: 553 mm × 558 mm × 267 mm (W × H × D) (Tilt: 35°)
	Dimensions (Without Stand)	553 mm × 345 mm × 64 mm (W × H × D)
	Net. weight	Approx. 8.5 kg
	Net Weight (Without Stand)	Approx. 5.7 kg
	Height adjustment	150 mm (Tilt: 0°) / 141mm (Tilt: 35°)
	Tilt	Up 35°, down 5°
	Swivel	344°
	Vertical Rotation	Right 90°
Operating Environment Requirements	Temperature	0°C to 35°C (32°F to 95°F)
	Humidity	20% to 80% R.H. (no condensation)
	Air Pressure	540 hPa to 1060 hPa
Transportation/ Storage Environment Requirements	Temperature	-20 °C to 60 °C (-4 °F to 140 °F)
	Humidity	10% to 90% R.H. (no condensation)
	Air Pressure	200 hPa to 1060 hPa

CG318-4K

LCD Panel	Type	IPS (Anti-Glare)	
	Backlight	Wide color gamut LED	
	Size	79 cm (31.1 inch) (78.9 cm diagonal)	
	Resolution	4096 dots × 2160 lines	
	Display Size (H × V)	697.95 mm × 368.06 mm	
	Pixel Pitch	0.1704 mm	
	Pixel Density	149 ppi	
	Display Colors	Approx. 1073.74 million colors (for 10 bit input)	
	Viewing Angle (H / V, typical)	178° / 178°	
	Recommended Brightness (typical)	120 cd/m ² or less (Temperature: 5000 K to 6500 K)	
	Contrast Ratio (typical)	1500 : 1 (When “DUE Priority” setting is “Brightness”)	
	Response Time (typical)	Black-white-black: 20 ms Gray-to-gray: 9 ms	
	Color Gamut Display (typical)	Adobe® RGB coverage: 99%, DCI-P3 coverage: 98%	
Video Signals	Input Terminals	DisplayPort 1.2 (HDCP 1.2-compatible) × 2, HDMI (HDCP 1.2, Deep Color-compatible) *1 × 2	
	Digital Scanning Frequency (H / V)	24.5 kHz to 137.5 kHz (DisplayPort), 14.5 kHz to 135.5 kHz (HDMI) / 22.5 Hz to 71.5 Hz (DisplayPort), 22.5 Hz to 71.5 Hz (HDMI)	
	Frame Synchronization Mode	23.75 Hz to 30.25 Hz, 47.5 Hz to 60.5 Hz	
	Dot clock (Max.)	598.3 MHz (DisplayPort), 300 MHz (HDMI)	
USB	Port	Upstream port × 1, downstream port × 3 (The “CHARGE” port supports quick recharging)	
	Standard	USB Specification Rev. 3.0 USB Battery Charging Specification Rev.1.2	
	Communication Speed	5 Gbps (super), 480 Mbps (high), 12 Mbps (full), 1.5 Mbps (low)	
	Supply Current	Downstream:	Max. 900 mA per port
		Downstream (CHARGE Port):	Normal: Max. 1.5 A per port, Charging Only: Max. 2.1 A per port
Power	Input	100–240 VAC ±10%, 50/60 Hz 1.45 A–0.75 A)	
	Maximum Power Consumption	140 W or less	
	Power Save Mode	9.0 W or less (no signal is input when there is no USB device connected)	
	Standby Mode	9.0 W or less (no signal is input when there is no USB device connected)	

*1 HDMI CEC (mutual control) is not supported.

Physical Specifications	Dimensions	Min. height: 735 mm × 434 mm × 245 mm (W × H × D) (Tilt: 0°) Max. height: 735 mm × 591 mm × 289 mm (W × H × D) (Tilt: 35°)
	Dimensions (Without Stand)	735 mm × 423 mm × 65.5 mm (W × H × D)
	Net. weight	Approx. 11.3 kg
	Net Weight (Without Stand)	Approx. 8.3 kg
	Height adjustment	149 mm (Tilt: 0°) / 141mm (Tilt: 35°)
	Tilt	Up 35°, down 5°
	Swivel	344°
Operating Environment Requirements	Temperature	0°C to 35 °C (32°F to 95°F) (when using landscape)/0°C to 30°C (32°F to 86°F) (when using portrait*2)
	Humidity	20% to 80% R.H. (no condensation)
	Air Pressure	540 hPa to 1060 hPa
Transportation/ Storage Environment Requirements	Temperature	-20 °C to 60 °C (-4 °F to 140 °F)
	Humidity	10% to 90% R.H. (no condensation)
	Air Pressure	200 hPa to 1060 hPa

*2 When using the monitor in a portrait position, you need to replace the stand with an arm.

● Dimensions

CG248-4K

Unit: mm

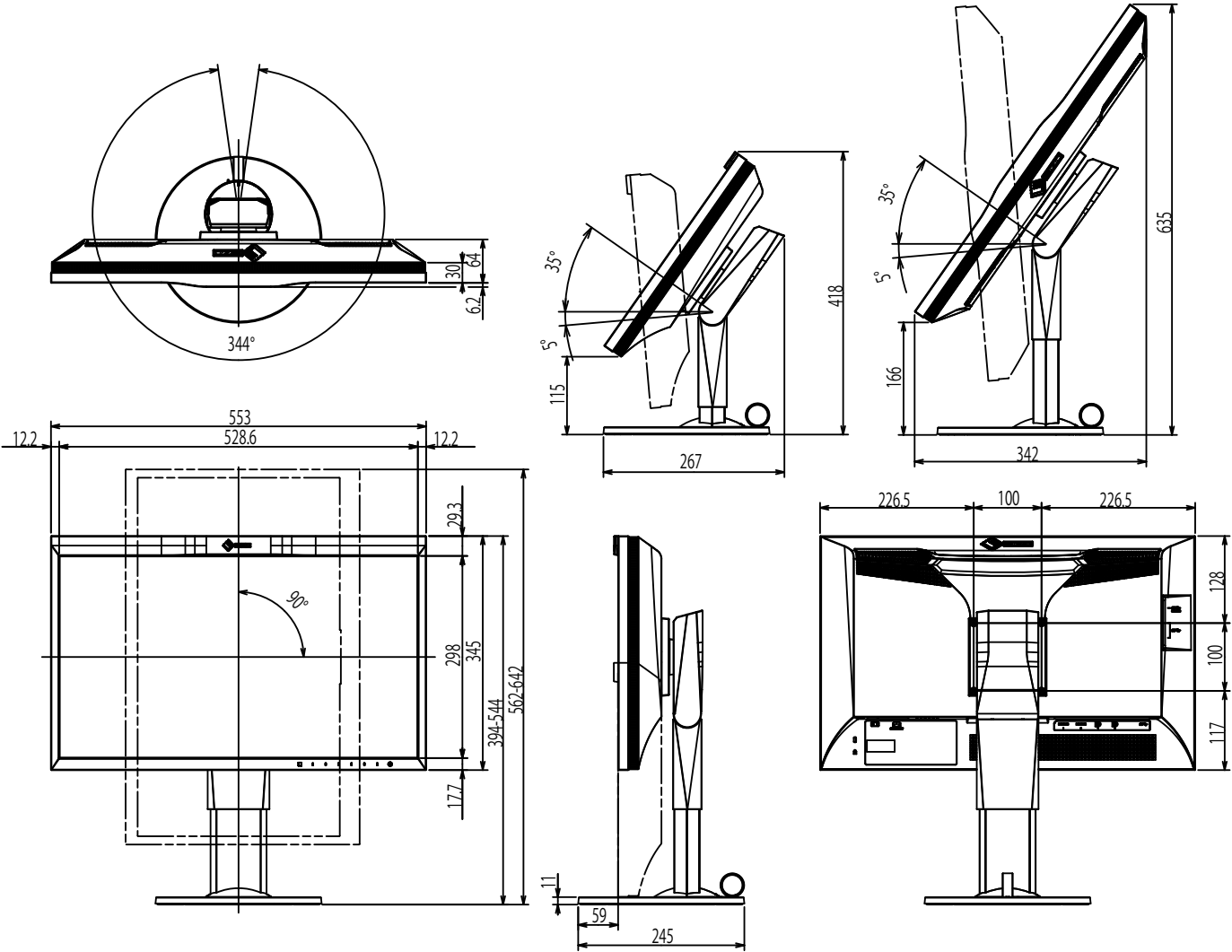

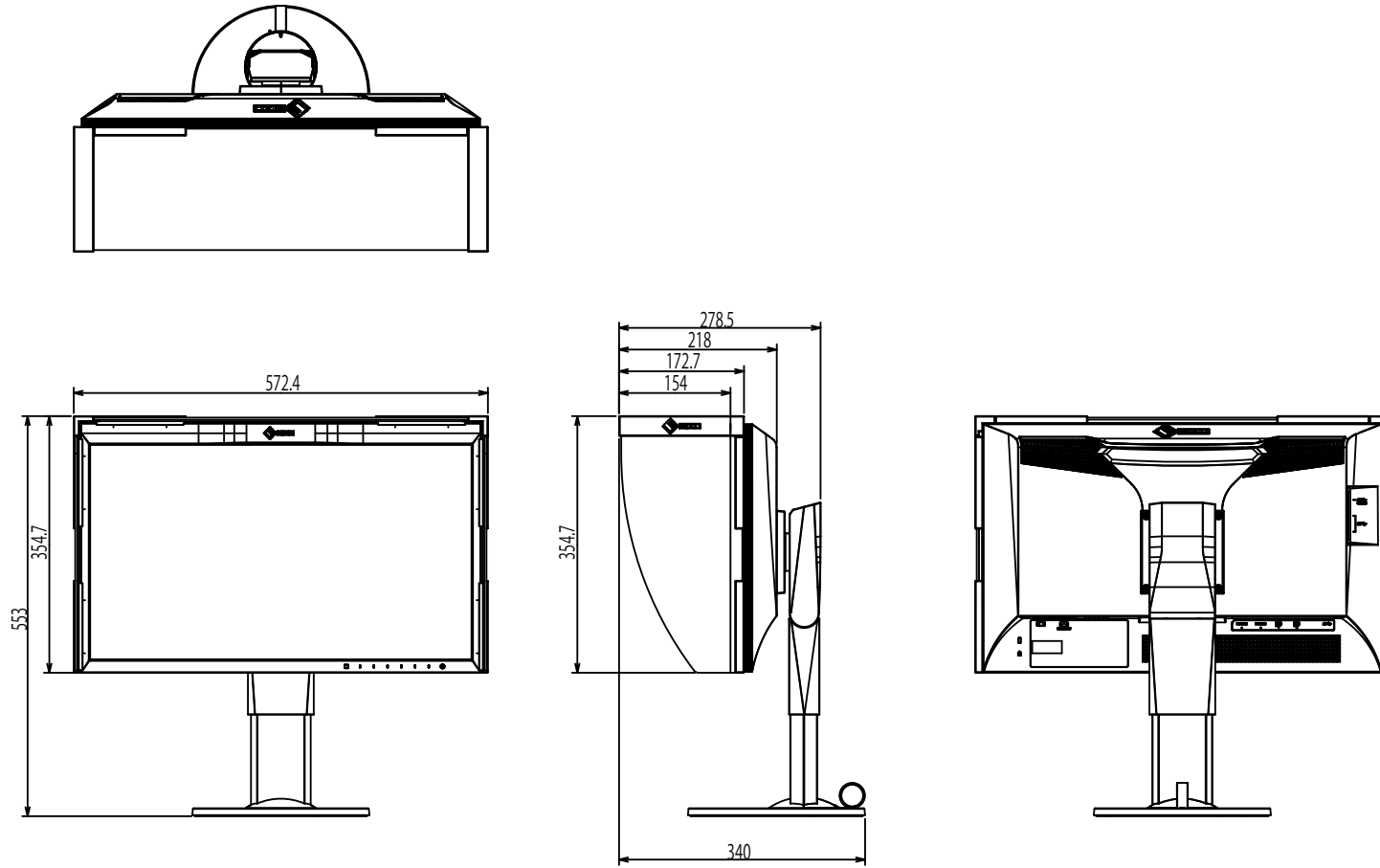

CG318-4K

Unit: mm

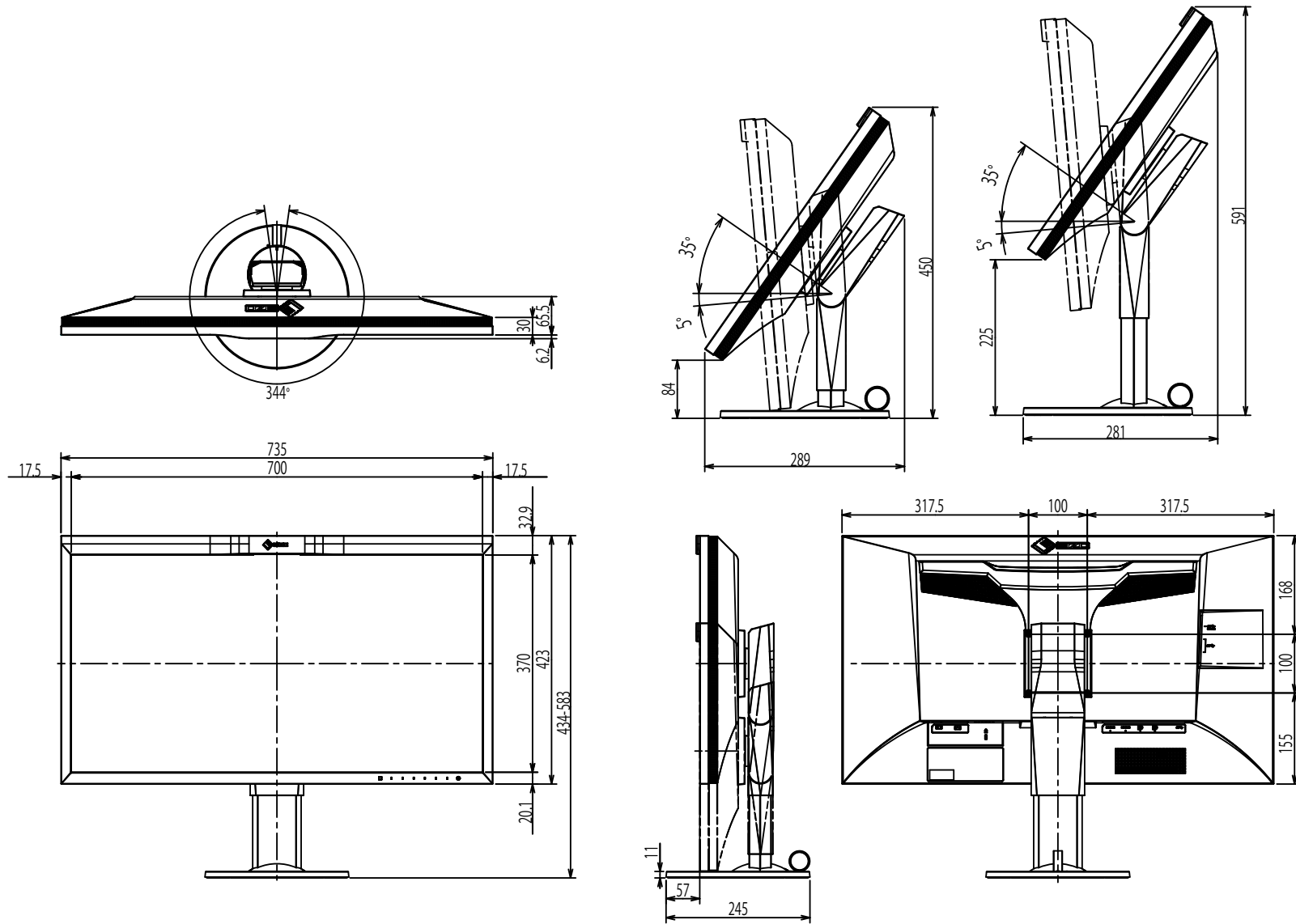

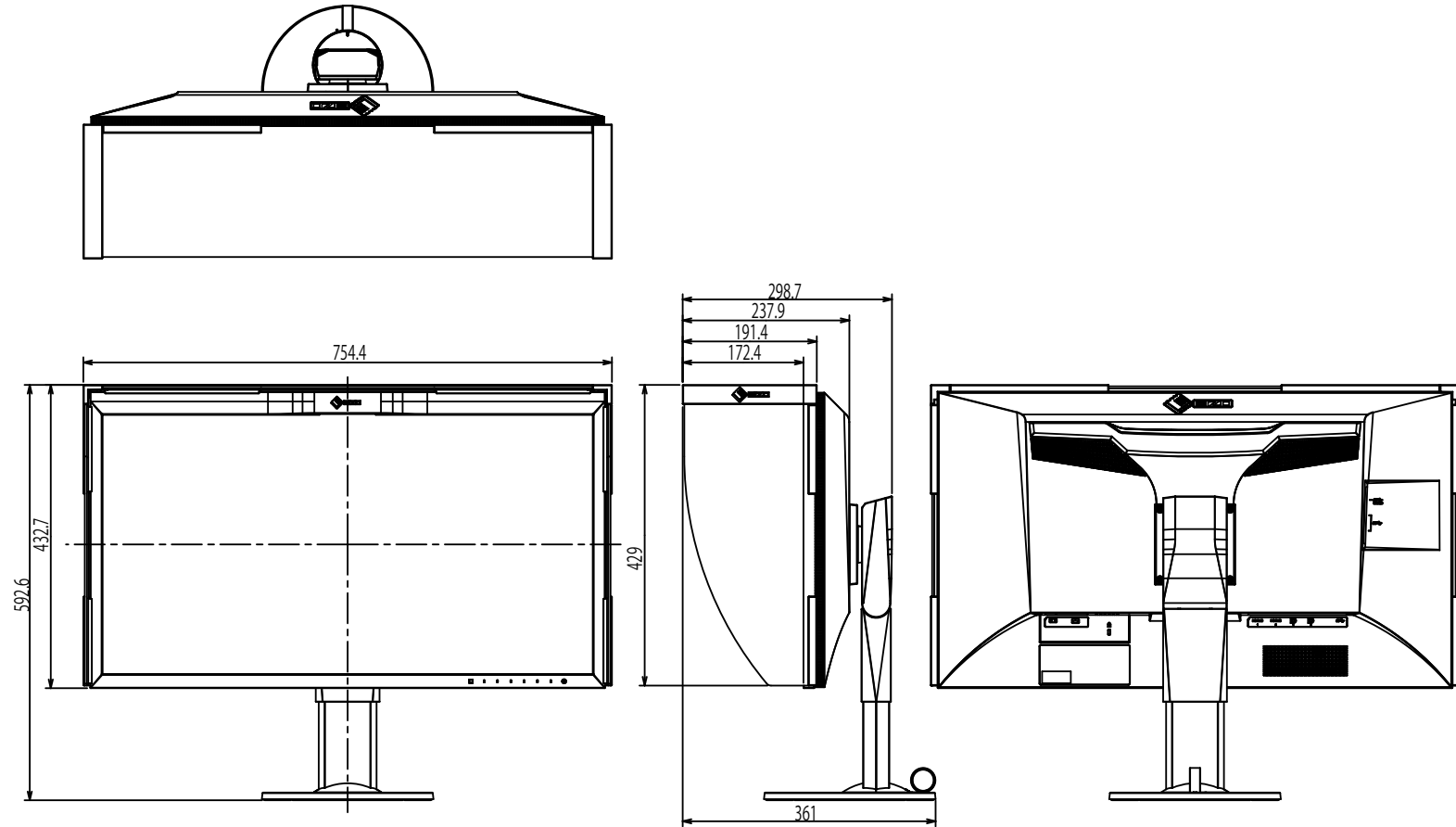

● Main Default Settings

Color Mode		Custom
REC709 Gamut Warning		On
Picture Expansion	DisplayPort input	Aspect Ratio
	HDMI (PC signal) input	Aspect Ratio
	HDMI (video signal) input	Auto
Input Color Format	DisplayPort input	Auto
	HDMI (PC signal) input	RGB
	HDMI (video signal) input	Auto
Range Extension	DisplayPort input	Auto
	HDMI (PC signal) input	Off
	HDMI (video signal) input	Auto
Super White		Off
Noise Reduction		Off
Film Detection		Off
Safe Area Marker		Off
Safe Area Size		80%
Border Color		White
Auto Input Detection		Off
Menu Rotation		0°
USB CHARGE Port		Normal
Power Save		On
Indicator		4
Beep		On
Language		English
Logo		On
Key Lock		Off
Picture Setup	DisplayPort	Single
	HDMI	Single
Signal Format	DisplayPort 1/DisplayPort 2	Ver.1.2
	HDMI 1/HDMI 2	Standard

● Accessories

Signal cable	HH200HS (HDMI – HDMI) PP200 (DisplayPort – DisplayPort) PM200 (DisplayPort – Mini DisplayPort)
--------------	--

For the latest information about the accessories, refer to our web site. <http://www.eizoglobal.com>

Chapter 7 Glossary

Adobe®RGB

This is a definition of the practical RGB color space proposed by Adobe Systems in 1998. The color reproduction range (color gamut) is broader than sRGB, and is highly adaptable to such fields as printing etc.

Color Space

YUV and RGB, etc. are available. YUV expresses the color by using the luminance (Y), the color difference of Blue (U), and the color difference of Red (V). RGB does this by using the gradation of the 3 colors, Red (R), Green (G), and Blue (B).

DCI (Digital Cinema Initiatives)

The company was founded by an association of U.S. film studios, and this company decides the specifications for digital cinema.

DisplayPort

This is the interface standard for image signals standardized in accordance with VESA. It was developed with the aim of replacing the conventional DVI and analog interfaces, and it can transmit high resolution signals and sound signals, which DVI does not support. The standard size and mini size connectors have been standardized.

DVI (Digital Visual Interface)

DVI is a digital interface standard. DVI allows direct transmission of the PC's digital data without loss.

This adopts the TMDS transmission system and DVI connectors. There are two types of DVI connectors. One is a DVI-D connector for digital signal input only. The other is a DVI-I connector for both digital and analog signal inputs.

EBU (European Broadcasting Union)

The organization also includes broadcasting offices from Europe and North Africa, and its role is to decide various technical standards etc.

Gain

This is used to adjust each color parameter for red, green and blue. An LCD monitor displays the color by the light passing through the panel color filter. Red, green and blue are the three primary colors. All the colors on the screen are displayed by combining these three colors. The color tone can be changed by adjusting the light intensity (volume) passing through each color's filter.

Gamma

Generally, the monitor brightness varies nonlinearly with the input signal level, which is called "Gamma Characteristic". When the gamma value is low, the middle tone area is displayed brighter, and darker when high. Changes to the gamma value will not affect contrast. A gamma value appropriate for the display content should be selected.

HDCP (High-bandwidth Digital Content Protection)

Digital signal coding system developed to copy-protect the digital contents, such as video, music, etc.

This helps to transmit the digital contents safely by coding the digital contents sent via the DVI or HDMI connector on the output side and decoding them on the input side.

Any digital contents cannot be reproduced if both of the equipments on the output and input sides are not applicable to HDCP system.

HDMI (High-Definition Multimedia Interface)

HDMI is a digital interface standard, developed for consumer electrical appliance or AV device. This standard is issued on the basis of the DVI standard which is one of an interface specification for the connection between a PC and a monitor. The projected image, sound and control signal without compressed enable to be transmitted with one cable.

REC709, REC2020

Digital broadcasting (HDTV, UHDTV) standards defined by the ITU-R (International Telecommunication Union Radio Communication Sector).

REC1886

Standards for the input/output characteristics of flat panel displays used in studio production for digital broadcasting (HDTV) specified by the ITU-R based on CRT characteristics.

Resolution

The LCD panel consists of numerous pixels of specified size, which are illuminated to form images. This monitor consists of horizontal 3840 pixels and 2160 vertical pixels (CG248-4K), or horizontal 4096 pixels and 2160 vertical pixels (CG318-4K). At a resolution of 3840 × 2160 (CG248-4K) or 4096 × 2160 (CG318-4K), all pixels are illuminated as a full screen (1:1).

SMPTE-C

One of the standards provided by the SMPTE (Society of Motion Picture and Television Engineers).

sRGB (Standard RGB)

International standard for color reproduction and color space among peripheral devices (such as monitors, printers, digital cameras, scanners). As a form of simple color matching for the Internet, colors can be displayed using tones close to those of the transmission and reception devices.

Temperature

Color temperature is a method to measure the white color tone, generally indicated in degrees Kelvin. The screen becomes reddish at a low temperature, and bluish at a high temperature, like the flame temperature.

5000 K: Slightly reddish white

6500 K: White referred to as daylight-balanced color

9300 K: Slightly bluish white

Appendix

Trademark

The terms HDMI and HDMI High-Definition Multimedia Interface, and the HDMI Logo are trademarks or registered trademarks of HDMI Licensing, LLC in the United States and other countries.

The DisplayPort Compliance Logo and VESA are registered trademarks of the Video Electronics Standards Association.

Acrobat, Adobe, Adobe AIR, and Photoshop are registered trademarks of Adobe Systems Incorporated in the United States and other countries.

AMD Athlon and AMD Opteron are trademarks of Advanced Micro Devices, Inc.

Apple, ColorSync, eMac, iBook, iMac, iPad, Mac, MacBook, Macintosh, Mac OS, PowerBook, and QuickTime are registered trademarks of Apple Inc.

ColorMunki, Eye-One, and X-Rite are registered trademarks or trademarks of X-Rite Incorporated in the United States and/or other countries.

ColorVision and ColorVision Spyder2 are registered trademarks of DataColor Holding AG in the United States.

Spyder3 and Spyder4 are trademarks of DataColor Holding AG.

ENERGY STAR is a registered trademark of the United States Environmental Protection Agency in the United States and other countries.

GRACoL and IDEAlliance are registered trademarks of International Digital Enterprise Alliance.

NEC is a registered trademark of NEC Corporation.

PC-9801 and PC-9821 are trademarks of NEC Corporation.

NextWindow is a trademark of NextWindow Ltd.

Intel, Intel Core, Pentium, and Thunderbolt are trademarks of Intel Corporation in the U.S. and/or other countries.

PowerPC is a registered trademark of International Business Machines Corporation.

PlayStation is a registered trademark of Sony Computer Entertainment Inc.

PSP and PS3 are trademarks of Sony Computer Entertainment Inc.

RealPlayer is a registered trademark of RealNetworks, Inc.

TouchWare is a trademark of 3M Touch Systems, Inc.

Windows, Windows Media, Windows Vista, SQL Server, Xbox 360, and Internet Explorer are registered trademarks of Microsoft Corporation in the United States and other countries.

YouTube is a registered trademark of Google Inc.

Firefox is a registered trademark of the Mozilla Foundation.

Kensington and MicroSaver are registered trademarks of ACCO Brands Corporation.

The SuperSpeed USB Trident Logo is a registered trademark of USB Implementers Forum, Inc.



Linux is a registered trademark of Linus Torvalds.

Red Hat is a registered trademark of Red Hat, Inc.

EIZO, the EIZO Logo, ColorEdge, DuraVision, FlexScan, FORIS, RadiCS, RadiForce, RadiNET, Raptor, and ScreenManager are registered trademarks of EIZO Corporation in Japan and other countries.

ColorNavigator, EcoView NET, EIZO EasyPIX, EIZO Monitor Configurator, EIZO ScreenSlicer, G-Ignition, i•Sound, Re/Vue, Screen Administrator and UniColor are trademarks of EIZO Corporation.

All other company and product names are trademarks or registered trademarks of their respective owners.

License / Copyright

A round gothic bold bit map font designed by Ricoh is used for the characters displayed on this product.

FCC Declaration of Conformity

For U.S.A. , Canada, etc. (rated 100-120 Vac) Only

FCC Declaration of Conformity

We, the Responsible Party

EIZO Inc.

5710 Warland Drive, Cypress, CA 90630

Phone: (562) 431-5011

declare that the product

Trade name: EIZO

Model: ColorEdge CG248/CG318

is in conformity with Part 15 of the FCC Rules. Operation of this product is subject to the following two conditions: (1) this device may not cause harmful interference, and (2) this device must accept any interference received, including interference that may cause undesired operation.

This equipment has been tested and found to comply with the limits for a Class B digital device, pursuant to Part 15 of the FCC Rules. These limits are designed to provide reasonable protection against harmful interference in a residential installation. This equipment generates, uses, and can radiate radio frequency energy and, if not installed and used in accordance with the instructions, may cause harmful interference to radio communications. However, there is no guarantee that interference will not occur in a particular installation. If this equipment does cause harmful interference to radio or television reception, which can be determined by turning the equipment off and on, the user is encouraged to try to correct the interference by one or more of the following measures.

- * Reorient or relocate the receiving antenna.
- * Increase the separation between the equipment and receiver.
- * Connect the equipment into an outlet on a circuit different from that to which the receiver is connected.
- * Consult the dealer or an experienced radio/TV technician for help.

Changes or modifications not expressly approved by the party responsible for compliance could void the user's authority to operate the equipment.

Note

Use the attached specified cable below or EIZO signal cable with this monitor so as to keep interference within the limits of a Class B digital device.

- AC Cord
- Shielded Signal Cable (enclosed)

Canadian Notice

This Class B digital apparatus complies with Canadian ICES-003.

Cet appareil numérique de la classe B est conforme à la norme NMB-003 du Canada.

Hinweise zur Auswahl des richtigen Schwenkarms für Ihren Monitor

Dieser Monitor ist für Bildschirmarbeitsplätze vorgesehen. Wenn nicht der zum Standardzubehör gehörige Schwenkarm verwendet wird, muss statt dessen ein geeigneter anderer Schwenkarm installiert werden. Bei der Auswahl des Schwenkarms sind die nachstehenden Hinweise zu berücksichtigen:

Der Standfuß muß den nachfolgenden Anforderungen entsprechen:

- a) Der Standfuß muß eine ausreichende mechanische Stabilität zur Aufnahme des Gewichtes vom Bildschirmgerät und des spezifizierten Zubehörs besitzen. Das Gewicht des Bildschirmgerätes und des Zubehörs sind in der zugehörigen Bedienungsanleitung angegeben.
- b) Die Befestigung des Standfusses muß derart erfolgen, daß die oberste Zeile der Bildschirmanzeige nicht höher als die Augenhöhe eines Benutzers in sitzender Position ist.
- c) Im Fall eines stehenden Benutzers muß die Befestigung des Bildschirmgerätes derart erfolgen, daß die Höhe der Bildschirmmitte über dem Boden zwischen 135 – 150 cm beträgt.
- d) Der Standfuß muß die Möglichkeit zur Neigung des Bildschirmgerätes besitzen (max. vorwärts: 5°, min. nach hinten \geq 5°).
- e) Der Standfuß muß die Möglichkeit zur Drehung des Bildschirmgerätes besitzen (max. $\pm 180^\circ$). Der maximale Kraftaufwand dafür muß weniger als 100 N betragen.
- f) Der Standfuß muß in der Stellung verharren, in die er manuell bewegt wurde.
- g) Der Glanzgrad des Standfusses muß weniger als 20 Glanzeinheiten betragen (seidenmatt).
- h) Der Standfuß mit Bildschirmgerät muß bei einer Neigung von bis zu 10° aus der normalen aufrechten Position kippsicher sein.

Hinweis zur Ergonomie :

Dieser Monitor erfüllt die Anforderungen an die Ergonomie nach EK1-ITB2000 mit dem Videosignal, 3840 × 2160 (CG248-4K) / 4096 × 2160 (CG318-4K), Digital Eingang und mindestens 30,0 Hz Bildwiederholfrequenz, non interlaced. Weiterhin wird aus ergonomischen Gründen empfohlen, die Grundfarbe Blau nicht auf dunklem Untergrund zu verwenden (schlechte Erkennbarkeit, Augenbelastung bei zu geringem Zeichenkontrast.)

„Maschinenlärminformations-Verordnung 3. GPSGV:

Der höchste Schalldruckpegel beträgt 70 dB(A) oder weniger gemäss EN ISO 7779“

LIMITED WARRANTY

LIMITED WARRANTY

EIZO Corporation (hereinafter referred to as “**EIZO**”) and distributors authorized by EIZO (hereinafter referred to as the “**Distributors**”) warrant, subject to and in accordance with the terms of this limited warranty (hereinafter referred to as the “**Warranty**”), to the original purchaser (hereinafter referred to as the “**Original Purchaser**”) who purchased the product specified in this document (hereinafter referred to as the “**Product**”) from EIZO or Distributors, that EIZO and Distributors shall, at their sole discretion, either repair or replace the Product at no charge if the Original Purchaser becomes aware within the Warranty Period (defined below) that the Product malfunctions or is damaged in the course of normal use of the Product in accordance with the description in the instruction manual attached to the Product (hereinafter referred to as the “**User’s Manual**”).

The period of this Warranty is limited to (i) five (5) years from the date of purchase of the Product; or, limited to the expiration of (ii) 30,000 hours of its use of the Product (hereinafter referred to as the “**Warranty Period**”). However, the brightness of the Product shall be warranted only if the Product has been used within the recommended brightness described in the User’s Manual. The Warranty Period for the brightness is also limited to five (5) years from the date of purchase of the Product subject to the usage time being less than or equal to 10,000 hours. EIZO and Distributors shall bear no liability or obligation with regard to the Product in relation to the Original Purchaser or any third parties other than as provided under this Warranty.

EIZO and Distributors will cease to hold or store any parts of the Product upon expiration of seven (7) years after the production of such parts is discontinued. In repairing the monitor, EIZO and Distributors will use renewal parts which comply with our QC standards.

The Warranty is valid only in the countries or territories where the Distributors are located. The Warranty does not restrict any legal rights of the Original Purchaser.

Notwithstanding any other provision of this Warranty, EIZO and Distributors shall have no obligation under this Warranty whatsoever in any of the cases as set forth below:

- (a) Any defect of the Product caused by freight damage, modification, alteration, abuse, misuse, accident, incorrect installation, disaster, faulty maintenance and/or improper repair by third party other than EIZO and Distributors;
- (b) Any incompatibility of the Product due to possible technical innovations and/or regulations;
- (c) Any deterioration of the sensor;
- (d) Any deterioration of display performance caused by the deterioration of expendable parts such as the LCD panel and/or backlight, etc. (e.g. changes in brightness uniformity, changes in color, changes in color uniformity, defects in pixels including burnt pixels, etc.);
- (e) Any deterioration of the Product caused by the use at higher brightness than the recommended brightness described in the User’s Manual;
- (f) Any defect of the Product caused by external equipment;
- (g) Any defect of the Product on which the original serial number has been altered or removed;
- (h) Any normal deterioration of the product, particularly that of consumables, accessories, and/or attachments (e.g. buttons, rotating parts, cables, User’s Manual, etc.); and
- (i) Any deformation, discoloration, and/or warp of the exterior of the product including that of the surface of the LCD panel.

To obtain service under the Warranty, the Original Purchaser must deliver the Product, freight prepaid, in its original package or other adequate package affording an equal degree of protection, assuming the risk of damage and/or loss in transit, to the local Distributor. The Original Purchaser must present proof of purchase of the Product and the date of such purchase when requesting services under the Warranty.

The Warranty Period for any replaced and/or repaired product under this Warranty shall expire at the end of the original Warranty Period.

EIZO OR DISTRIBUTORS ARE NOT RESPONSIBLE FOR ANY DAMAGE TO, OR LOSS OF, DATA OR OTHER INFORMATION STORED IN ANY MEDIA OR ANY PART OF ANY PRODUCT RETURNED TO EIZO OR DISTRIBUTORS FOR REPAIR.

EIZO AND DISTRIBUTORS MAKE NO FURTHER WARRANTIES, EXPRESSED OR IMPLIED, WITH RESPECT TO THE PRODUCT AND ITS QUALITY, PERFORMANCE, MERCHANTABILITY OR FITNESS FOR ANY PARTICULAR USE. IN NO EVENT SHALL EIZO OR DISTRIBUTORS BE LIABLE FOR ANY INCIDENTAL, INDIRECT, SPECIAL, CONSEQUENTIAL OR OTHER DAMAGE WHATSOEVER (INCLUDING, WITHOUT LIMITATION, DAMAGES FOR LOSS OF PROFIT, BUSINESS INTERRUPTION, LOSS OF BUSINESS INFORMATION, OR ANY OTHER PECUNIARY LOSS) ARISING OUT OF THE USE OR INABILITY TO USE THE PRODUCT OR IN ANY CONNECTION WITH THE PRODUCT, WHETHER BASED ON CONTRACT, TORT, NEGLIGENCE, STRICT LIABILITY OR OTHERWISE, EVEN IF EIZO OR DISTRIBUTORS HAVE BEEN ADVISED OF THE POSSIBILITY OF SUCH DAMAGES. THIS EXCLUSION ALSO INCLUDES ANY LIABILITY WHICH MAY ARISE OUT OF THIRD PARTY CLAIMS AGAINST THE ORIGINAL PURCHASER. THE ESSENCE OF THIS PROVISION IS TO LIMIT THE POTENTIAL LIABILITY OF EIZO AND DISTRIBUTORS ARISING OUT OF THIS LIMITED WARRANTY AND/OR SALES.

BEGRENZTE GARANTIE

EIZO Corporation (im Weiteren als „**EIZO**“ bezeichnet) und die Vertragsimporteure von EIZO (im Weiteren als „**Vertrieb(e)**“ bezeichnet) garantieren dem ursprünglichen Käufer (im Weiteren als „**Erstkäufer**“ bezeichnet), der das in diesem Dokument vorgegebene Produkt (im Weiteren als „**Produkt**“ bezeichnet) von EIZO oder einem Vertrieb erworben hat, gemäß den Bedingungen dieser beschränkten Garantie (im Weiteren als „**Garantie**“ bezeichnet), dass EIZO und der Vertrieb nach eigenem Ermessen das Produkt entweder kostenlos reparieren oder austauschen, falls der Erstkäufer innerhalb der Garantiefrist (weiter unten festgelegt) eine Fehlfunktion bzw. Beschädigung des Produkts feststellt, die während des normalen Gebrauchs des Produkts gemäß den Anweisungen des zum Lieferumfang des Produkts gehörenden Benutzerhandbuchs (im Weiteren als „**Benutzerhandbuch**“ bezeichnet) aufgetreten ist.

Die Dauer der Garantieleistung beträgt (i) fünf (5) Jahre ab dem Erstverkaufsdatum des Produkts oder (ii) 30.000 Betriebsstunden des Produkts (im Weiteren als „**Garantiefrist**“ bezeichnet). Die Helligkeit des Produkts wird allerdings nur garantiert, wenn das Produkt innerhalb der empfohlenen Helligkeit, wie im Benutzerhandbuch beschrieben, verwendet wird. Die Dauer der Garantiefrist für die Helligkeit ist außerdem auf fünf (5) Jahre ab dem Kaufdatum des Produkts beschränkt, vorausgesetzt, dass die Nutzungszeit des Produkts maximal 10.000 Betriebsstunden. EIZO und die Vertriebe übernehmen über den Rahmen dieser Garantie hinaus hinsichtlich des Produkts keinerlei Haftung oder Verpflichtung dem Erstkäufer oder Dritten gegenüber.

EIZO und die Vertriebe verpflichten sich, Ersatzteile für das Produkt über einen Zeitraum von sieben (7) Jahren nach Einstellung der Produktion der Ersatzteile zu lagern bzw. anzubieten. EIZO und seine Vertriebspartner verpflichten sich, bei einer etwaigen Reparatur des Monitors ausschließlich Produkte gemäß den EIZO-Qualitätssicherungsstandards zu verwenden.

Diese Garantie gilt nur in Ländern oder Gebieten, in denen sich Vertriebe befinden. Die gesetzlichen Gewährleistungsrechte des Erstkäufers gegenüber dem Verkäufer werden durch diese Garantie nicht berührt.

EIZO und die Vertriebe besitzen im Rahmen dieser Garantie keinerlei Verpflichtung in den folgenden Fällen:

- (a) Produktdefekte, die auf Frachtschäden, Modifikation, Nachgestaltung, Missbrauch, Fehlbedienung, Unfälle, unsachgemäße Installation, Naturkatastrophen, fehlerhafte Wartung und/oder unsachgemäße Reparatur durch eine andere Partei als EIZO und die Vertriebe zurückzuführen sind.
- (b) Eine Inkompatibilität des Produkts aufgrund von technischen Neuerungen und/oder neuen Bestimmungen, die nach dem Kauf in Kraft treten.
- (c) Jegliche Verschlechterung des Sensors.
- (d) Jegliche Verschlechterung der Bildschirmleistung, die durch Verschleißteile wie das LCD-Panel und/oder die Hintergrundbeleuchtung usw. hervorgerufen werden (z.B. Veränderungen von Helligkeitsverteilung, Veränderungen von Farbe oder Farbverteilung, Pixeldefekte einschließlich von durchgebrannten Pixeln usw.).
- (e) Jegliche Abnutzung des Produkts, die auf einen Gebrauch mit einer höheren Helligkeit als die im Benutzerhandbuch genannte empfohlene Helligkeit zurückzuführen ist.
- (f) Produktdefekte, die durch externe Geräte verursacht werden.
- (g) Jeglicher Defekt eines Produkts, dessen ursprüngliche Seriennummer geändert oder entfernt wurde.
- (h) Normale Abnutzung des Produkts, insbesondere von Verbrauchsteilen, Zubehörteilen und/oder Beilagen (z.B. Tasten, drehbare Teile, Kabel, Benutzerhandbuch usw.); sowie
- (i) Verformungen, Verfärbungen und/oder Verziehungen am Produktäußeren, einschließlich der Oberfläche des LCD-Panels.

Bei Inanspruchnahme der Garantieleistung ist der Erstkäufer verpflichtet, das Produkt auf eigene Kosten und in der Originalverpackung bzw. einer anderen geeigneten Verpackung, die einen gleichwertigen Schutz gegen Transportschäden bietet, an den örtlichen Vertrieb zu übersenden, wobei der Erstkäufer das Transportrisiko gegenüber Schäden und/oder Verlust trägt. Zum Zeitpunkt der Inanspruchnahme der Garantieleistung muss der Erstkäufer einen Verkaufsbeleg vorweisen, auf dem das Kaufdatum angegeben ist.

Die Garantiefrist für ein im Rahmen dieser Garantie ausgetauschtes und/oder repariertes Produkt erlischt nach Ablauf der ursprünglichen Garantiefrist.

EIZO ODER DIE EIZO-VERTRAGSIMPORTEURE HAFTEN NICHT FÜR ZERSTÖRTE DATENBESTÄNDE ODER DIE KOSTEN DER WIEDERBESCHAFFUNG DIESER DATENBESTÄNDE AUF JEDLICHEN DATENTRÄGERN ODER TEILEN DES PRODUKTS, DIE IM RAHMEN DER GARANTIE BEI EIZO ODER DEN EIZO-VERTRAGSIMPORTEUREN ZUR REPARATUR EINGEREICHT WURDEN.

EIZO UND DIE EIZO-VERTRAGSIMPORTEURE GEBEN WEDER EXPLIZITE NOCH IMPLIZITE GARANTIE IN BEZUG AUF DIESES PRODUKT UND SEINE QUALITÄT, LEISTUNG, VERKÄUFLICHKEIT ODER EIGNUNG FÜR EINEN BESTIMMTEN ZWECK. AUF KEINEN FALL SIND EIZO ODER DIE EIZO-VERTRAGSIMPORTEURE VERANTWORTLICH FÜR JEDLICHE ZUFÄLLIGE, INDIREKTE, SPEZIELLE, FOLGE- ODER ANDERE SCHÄDEN JEDLICHER ART (EINSCHLIESSLICH OHNE JEDE BEGRENZUNG SCHÄDEN BEZÜGLICH PROFITVERLUST, GESCHÄFTSUNTERBRECHUNG, VERLUST VON GESCHÄFTSINFORMATION ODER JEDLICHE ANDEREN FINANZIELLEN EINBUSSEN), DIE DURCH DIE VERWENDUNG DES PRODUKTES ODER DIE UNFÄHIGKEIT ZUR VERWENDUNG DES PRODUKTES ODER IN JEDLICHER BEZIEHUNG MIT DEM PRODUKT, SEI ES BASIEREND AUF VERTRAG, SCHADENSERSATZ, NACHLAESSIGKEIT, STRIKTE HAFTPFLICHT ODER ANDEREN FORDERUNGEN ENTSTEHEN, AUCH WENN EIZO UND DIE EIZO-VERTRAGSIMPORTEURE IM VORAUSS ÜBER DIE MÖGLICHKEIT SOLCHER SCHÄDEN INFORMIERT WURDEN. DIESER AUSSCHLUSS ENTHÄLT AUCH JEDE HAFTPFLICHT, DIE AUS FORDERUNGEN DRITTER GEGEN DEN ERSTKÄUFER ENTSTEHEN KANN. ZWECK DIESER KLAUSEL IST ES, DIE HAFTUNG VON EIZO UND DEN VERTRIEBEN GEGENÜBER FORDERUNGEN ZU BEGRENZEN, DIE AUS DIESER BESCHRÄNKTEN GARANTIE UND/ODER DEM VERKAUF ENTSTEHEN KÖNNEN.

GARANTIE LIMITÉE

EIZO Corporation (ci-après dénommé « **EIZO** ») et les distributeurs autorisés par EIZO (ci-après dénommés « **Distributeurs** »), sous réserve et conformément aux termes de cette garantie limitée (ci-après dénommée « **Garantie** »), garantissent à l'acheteur initial (ci-après dénommé « **Acheteur initial** ») du produit spécifié dans la présente (ci-après dénommé « **Produit** ») acheté auprès d'EIZO ou de Distributeurs agréés EIZO, que EIZO et ses Distributeurs auront pour option de réparer ou remplacer gratuitement le Produit si l'Acheteur initial constate, pendant la Période de garantie (définie ci-dessous), qu'il y a un dysfonctionnement ou que le Produit a subi un dommage dans le cadre d'une utilisation normale du Produit conformément à la description du mode d'emploi qui accompagne le Produit (ci-après dénommé « **Manuel d'utilisation** »).

La période de cette Garantie est limitée à (i) cinq (5) ans à partir de la date d'achat du Produit ; ou, limitée jusqu'à l'expiration de (ii) 30 000 heures d'utilisation du Produit (ci-après dénommée « **Période de Garantie** »). Cependant, la luminosité du Produit ne sera garantie que si le Produit a été utilisé conformément à la luminosité recommandée dans le Manuel d'Utilisation. La Période de Garantie en matière de luminosité est également limitée à cinq (5) ans à compter de la date d'achat du Produit, sous réserve que la durée d'utilisation soit inférieure ou égale à 10 000 heures. EIZO et ses Distributeurs déclinent toute responsabilité ou obligation concernant ce Produit face à l'Acheteur initial ou à toute autre personne à l'exception de celles stipulées dans la présente Garantie.

EIZO et ses Distributeurs cesseront de tenir ou conserver en stock toute pièce de ce Produit après l'expiration de la période de sept (7) ans suivant l'arrêt de la production de telles pièces. Pour réparer le moniteur, EIZO et ses distributeurs utiliseront des pièces de rechange conformes à nos normes de contrôle qualité.

La Garantie est valable uniquement dans les pays ou les territoires où se trouvent les Distributeurs. La Garantie ne limite aucun des droits reconnus par la loi à l'Acheteur initial.

Nonobstant toute autre clause de cette Garantie, EIZO et ses Distributeurs n'auront d'obligation dans le cadre de cette Garantie pour aucun des cas énumérés ci-dessous :

- (a) Tout défaut du Produit résultant de dommages occasionnés lors du transport, d'une modification, d'une altération, d'un abus, d'une mauvaise utilisation, d'un accident, d'une installation incorrecte, d'un désastre, d'un entretien et/ou d'une réparation incorrects effectués par une personne autre que EIZO ou ses Distributeurs ;
- (b) Toute incompatibilité du Produit résultant d'améliorations techniques et/ou réglementations possibles ;
- (c) Toute détérioration du capteur ;
- (d) Toute détérioration des performances d'affichage causée par la détérioration des éléments consommables tels que le panneau LCD et/ou le rétroéclairage, etc. (par exemple des changements de l'uniformité de la luminosité, des modifications de couleur, des changements de l'uniformité des couleurs, des défauts de pixels y compris des pixels brûlés, etc.);
- (e) Toute détérioration du Produit causée par l'utilisation d'une luminosité plus élevée que la luminosité recommandée, telle que décrite dans le Manuel d'utilisation ;
- (f) Tout défaut du Produit causé par un appareil externe ;
- (g) Tout défaut d'un Produit sur lequel le numéro de série original a été altéré ou supprimé ;
- (h) Toute détérioration normale du Produit, particulièrement celle des consommables, des accessoires et/ou des pièces reliées au Produit (touches, éléments pivotants, câbles, Manuel d'utilisation etc.), et
- (i) Toute déformation, décoloration, et/ou gondolage de l'extérieur du Produit, y compris celle de la surface du panneau LCD.

Pour bénéficier d'un service dans le cadre de cette Garantie, l'Acheteur initial doit renvoyer le Produit port payé, dans son emballage d'origine ou tout autre emballage approprié offrant un degré de protection équivalent, au Distributeur local, et assumera la responsabilité des dommages et/ou perte possibles lors du transport. L'Acheteur initial doit présenter une preuve d'achat du Produit comprenant sa date d'achat pour bénéficier de ce service dans le cadre de la Garantie.

La Période de garantie pour tout Produit remplacé et/ou réparé dans le cadre de cette Garantie expirera à la fin de la Période de garantie initiale.

EIZO OU SES DISTRIBUTEURS NE SAURAIENT ÊTRE TENUS RESPONSABLES DES DOMMAGES OU PERTES DE DONNÉES OU D'AUTRES INFORMATIONS STOCKÉES DANS UN MÉDIA QUELCONQUE OU UNE AUTRE PARTIE DU PRODUIT RENVOYÉ À EIZO OU AUX DISTRIBUTEURS POUR RÉPARATION.

AUCUNE AUTRE GARANTIE, EXPLICITE OU TACITE, N'EST OFFERTE PAR EIZO ET SES DISTRIBUTEURS CONCERNANT LE PRODUIT ET SES QUALITÉS, PERFORMANCES, QUALITÉ MARCHANDE OU ADAPTATION À UN USAGE PARTICULIER. EN AUCUN CAS, EIZO OU SES DISTRIBUTEURS NE SERONT RESPONSABLES DES DOMMAGES FORTUITS, INDIRECTS, SPÉCIAUX, INDUITS, OU DE TOUT AUTRE DOMMAGE QUEL QU'IL SOIT (Y COMPRIS, SANS LIMITATION, LES DOMMAGES RÉSULTANT D'UNE PERTE DE PROFIT, D'UNE INTERRUPTION D'ACTIVITÉS, D'UNE PERTE DE DONNÉES COMMERCIALES, OU DE TOUT AUTRE MANQUE À GAGNER) RÉSULTANT DE L'UTILISATION OU DE L'INCAPACITÉ D'UTILISER LE PRODUIT OU AYANT UN RAPPORT QUELCONQUE AVEC LE PRODUIT, QUE CE SOIT SUR LA BASE D'UN CONTRAT, D'UN TORT, D'UNE NÉGLIGENCE, D'UNE RESPONSABILITÉ STRICTE OU AUTRE, MÊME SI EIZO OU SES DISTRIBUTEURS ONT ÉTÉ AVERTIS DE LA POSSIBILITÉ DE TELS DOMMAGES. CETTE LIMITATION INCLUT AUSSI TOUTE RESPONSABILITÉ QUI POURRAIT ÊTRE SOULEVÉE LORS DES RÉCLAMATIONS D'UN TIERS CONTRE L'ACHETEUR INITIAL. L'ESSENCE DE CETTE CLAUSE EST DE LIMITER LA RESPONSABILITÉ POTENTIELLE DE EIZO ET DE SES DISTRIBUTEURS RÉSULTANT DE CETTE GARANTIE LIMITÉE ET/OU DES VENTES.

GARANTÍA LIMITADA

EIZO Corporation (en lo sucesivo “**EIZO**”) y sus distribuidores autorizados (en lo sucesivo los “**Distribuidores**”), con arreglo y de conformidad con los términos de esta garantía limitada (en lo sucesivo la “**Garantía**”), garantizan al comprador original (en lo sucesivo el “**Comprador original**”) que compró el producto especificado en este documento (en lo sucesivo el “**Producto**”) a EIZO o a sus Distribuidores, que EIZO y sus Distribuidores, a su propio criterio, repararán o sustituirán el Producto de forma gratuita si el Comprador original detecta dentro del periodo de la Garantía (indicado posteriormente) que el Producto no funciona correctamente o que se ha averiado durante el uso normal del mismo de acuerdo con las indicaciones del manual de instrucciones suministrado con el Producto (en lo sucesivo el “**Manual del usuario**”).

El período de validez de esta Garantía está limitado a (i) cinco (5) años a partir de la fecha de compra del Producto o (ii) a 30.000 horas de uso del Producto (en adelante designado como el “**Periodo de Garantía**”). De cualquier forma el brillo del Producto sólo estará cubierto por la garantía si el Producto se ha utilizado con el brillo recomendado que se describe en el Manual del usuario. El Periodo de garantía para el brillo está también limitado a cinco (5) años a partir de la fecha de compra del Producto, siempre que el tiempo de uso sea inferior o igual a 10.000 horas. EIZO y sus Distribuidores no tendrán ninguna responsabilidad ni obligación con respecto al Producto para con el Comprador original ni para con terceros que no sean las estipuladas en la presente Garantía.

EIZO y sus Distribuidores no estarán obligados a suministrar cualquier recambio del Producto una vez pasados siete (7) años desde que se deje de fabricar el mismo. Para la reparación del monitor, EIZO y los distribuidores utilizarán repuestos que cumplan con nuestros estándares de control de calidad.

La Garantía es válida sólo en los países y territorios donde están ubicados los Distribuidores. La Garantía no restringe ningún derecho legal del Comprador original.

A pesar de las estipulaciones de esta Garantía, EIZO y sus Distribuidores no tendrán obligación alguna bajo esta Garantía en ninguno de los casos expuestos a continuación:

- (a) Cualquier defecto del Producto causado por daños en el transporte, modificación, alteración, abuso, uso incorrecto, accidente, instalación incorrecta, desastre, mantenimiento incorrecto y/o reparación indebida realizada por un tercero que no sea EIZO o sus Distribuidores.
- (b) Cualquier incompatibilidad del Producto debida a posibles innovaciones técnicas y/o reglamentaciones.
- (c) Cualquier deterioro del sensor.
- (d) Cualquier deterioro en el rendimiento de la visualización causado por fallos en las piezas consumibles como el panel LCD y/o la "Backlight", etc. (p. ej. cambios de uniformidad del brillo, cambios de color, cambios de uniformidad del color, defectos de píxeles, incluyendo píxeles muertos, etc.).
- (e) Cualquier deterioro del Producto causado por el uso continuado con un brillo superior al recomendado en el Manual del usuario.
- (f) Cualquier defecto del Producto causado por un equipo externo.
- (g) Cualquier defecto del Producto en el que haya sido alterado o borrado el número de serie original.
- (h) Cualquier deterioro normal del Producto, y en particular de las piezas consumibles, accesorios y demás (p. ej. botones, piezas giratorias, cables, Manual del usuario, etc.).
- (i) Cualquier deformación, decoloración y/o alabeo del exterior del Producto incluida la superficie del panel LCD.

Para obtener servicio en los términos de esta Garantía, el Producto deberá ser enviado por el Comprador original, a su Distribuidor local, con el transporte previamente pagado, en el embalaje original u otro embalaje adecuado que ofrezca el mismo grado de protección, asumiendo el riesgo de daños y/o pérdida del Producto durante el transporte. El Comprador original deberá presentar un comprobante de compra del Producto en el que se refleje la fecha de compra del mismo cuando lo solicite el servicio de Garantía.

El Periodo de garantía para cualquier Producto reemplazado y/o reparado en los términos de esta Garantía expirará al vencer el Periodo de garantía original.

EIZO O LOS DISTRIBUIDORES AUTORIZADOS DE EIZO NO SE RESPONSABILIZAN DE NINGÚN DAÑO O PÉRDIDA QUE PUEDAN SUFRIR LOS DATOS U OTRA INFORMACIÓN ALMACENADA EN CUALQUIER MEDIO O CUALQUIER PARTE DE CUALQUIER PRODUCTO DEVUELTO A EIZO O A LOS DISTRIBUIDORES DE EIZO PARA SU REPARACIÓN.

EIZO Y LOS DISTRIBUIDORES AUTORIZADOS DE EIZO NO OFRECEN NINGUNA OTRA GARANTÍA, IMPLÍCITA NI EXPLÍCITA, CON RESPECTO AL PRODUCTO Y A SU CALIDAD, RENDIMIENTO, COMERCIALIZACIÓN E IDONEIDAD PARA CUALQUIER USO EN PARTICULAR. EN NINGÚN CASO SERÁN EIZO O LOS DISTRIBUIDORES AUTORIZADOS DE EIZO RESPONSABLES DE NINGÚN DAÑO EMERGENTE, INDIRECTO, ESPECIAL, INHERENTE O CUALQUIERA QUE SEA (INCLUYENDO, SIN LIMITACIÓN, DAÑOS POR LUCRO CESANTE, INTERRUPCIÓN DE LA ACTIVIDAD COMERCIAL, PÉRDIDA DE INFORMACIÓN COMERCIAL O CUALQUIER OTRA PÉRDIDA PECUNIARIA) QUE SE DERIVE DEL USO O IMPOSIBILIDAD DE USO DEL PRODUCTO O EN RELACIÓN CON EL PRODUCTO, YA SEA BASADO EN CONTRATO, POR AGRAVIO, NEGLIGENCIA, ESTRICTA RESPONSABILIDAD O CUALQUIERA QUE SEA, AUN CUANDO SE HAYA ADVERTIDO A EIZO O A LOS DISTRIBUIDORES DE EIZO DE LA POSIBILIDAD DE TALES DAÑOS. ESTA EXCLUSIÓN TAMBIÉN ABARCA CUALQUIER RESPONSABILIDAD QUE PUEDA DERIVARSE DE RECLAMACIONES HECHAS POR UN TERCERO CONTRA EL COMPRADOR ORIGINAL. LA ESENCIA DE ESTA ESTIPULACIÓN ES LIMITAR LA RESPONSABILIDAD POTENCIAL DE EIZO Y LOS DISTRIBUIDORES QUE PUDIERA DERIVARSE DE ESTA GARANTÍA LIMITADA Y/O VENTAS.

GARANZIA LIMITATA

EIZO Corporation (a cui si farà riferimento da qui in poi con “**EIZO**”) ed i Distributori autorizzati da EIZO (a cui si farà riferimento da qui in poi con “**Distributori**”) garantiscono, secondo i termini di questa garanzia limitata (a cui si farà riferimento da qui in poi con “**Garanzia**”) all’acquirente originale (a cui si farà riferimento da qui in poi con “**Acquirente originale**”) che ha acquistato il prodotto specificato in questo documento (a cui si farà riferimento da qui in poi con “**Prodotto**”) da EIZO o dai suoi Distributori, che EIZO e i distributori, a loro discrezione, ripareranno o sostituiranno il Prodotto senza addebito se l’Acquirente originale trova, entro il periodo della Garanzia (definito sotto), che il Prodotto malfunziona e si è danneggiato nel corso del suo normale utilizzo osservando le indicazioni del manuale di istruzioni allegato al Prodotto (a cui si farà riferimento da qui in poi con “**Manuale utente**”).

La presente Garanzia è limitata a (i) cinque (5) anni a partire dalla data d’acquisto del Prodotto o (ii) allo scadere di 30.000 ore d’utilizzo del Prodotto (a cui si farà riferimento da qui in poi con “**Periodo di Garanzia**”). Tuttavia, la luminosità del Prodotto sarà garantita solo se il Prodotto è stato utilizzato con la luminosità consigliata descritta nel Manuale utente. Il Periodo di Garanzia per la luminosità è inoltre limitato a cinque (5) anni dalla data di acquisto del Prodotto, a condizione che il tempo di utilizzo sia inferiore o uguale a 10.000 ore. EIZO e i suoi Distributori non si assumono alcuna responsabilità e non hanno alcun obbligo riguardo al Prodotto verso l’Acquirente originale o terzi diversi da quelli relativi a questa Garanzia.

EIZO e i suoi Distributori cesseranno di tenere o di conservare qualsiasi ricambio del Prodotto allo scadere di sette (7) anni dopo che la produzione di tali ricambi è stata terminata. Per la riparazione del monitor, EIZO e i Distributori utilizzeranno parti di ricambio conformi ai nostri standard di controllo della qualità.

La Garanzia è valida soltanto nei paesi dove ci sono i Distributori EIZO. La Garanzia non limita alcun diritto legale dell’Acquirente originale.

Indipendentemente da qualsiasi altra condizione di questa Garanzia, EIZO e i suoi Distributori non avranno alcun obbligo derivante da questa Garanzia in ognuno dei casi elencati di seguito:

- (a) Qualsiasi difetto del Prodotto causato da danni di trasporto, modifiche, alterazioni, abusi, usi impropri, incidenti, installazione errata, calamità, manutenzione errata e/o riparazioni improprie eseguite da terze parti che non siano EIZO o i suoi Distributori.
- (b) Qualsiasi incompatibilità del Prodotto dovuta a possibili innovazioni tecniche e/o normative.
- (c) Qualsiasi deterioramento del sensore.
- (d) Qualsiasi deterioramento delle prestazioni dello schermo causato dal deterioramento delle parti consumabili, come il pannello LCD e/o la retroilluminazione, ecc. (per esempio: i cambiamenti di uniformità della luminosità, i cambiamenti di colore, i cambiamenti di uniformità del colore, i difetti dei pixel, inclusi i pixel bruciati, ecc.).
- (e) Qualsiasi deterioramento del Prodotto causato dal suo utilizzo ad una luminosità più alta di quella raccomandata nel Manuale utente.
- (f) Qualsiasi difetto del Prodotto causato da apparecchiature esterne.
- (g) Qualsiasi difetto del Prodotto in cui il numero di serie originale sia stato alterato o rimosso.
- (h) Qualsiasi normale deterioramento del Prodotto, in particolar modo nelle sue parti di consumo, accessori, e/o attacchi (per esempio: tasti, parti rotanti, cavi, Manuale dell’utente, ecc.).
- (i) Qualsiasi tipo di deformazione, scolorimento, e/o di involucro esterno del Prodotto inclusa la superficie del pannello LCD.

Per ricevere assistenza tecnica con questa Garanzia, l’Acquirente originale deve inviare il Prodotto, con trasporto pre-pagato, nella sua confezione originale o altra confezione adeguata che fornisce un livello analogo di protezione, assumendosi il rischio di danni e/o perdita in transito, al Distributore locale. L’Acquirente originale deve presentare la prova di acquisto che stabilisce la data di acquisto del Prodotto quando richiede servizio sotto Garanzia.

Il Periodo di garanzia per qualsiasi Prodotto sostituito e/o riparato sotto questa Garanzia scade alla fine del Periodo di garanzia originale.

EIZO O I SUOI DISTRIBUTORI NON SONO RESPONSABILI PER QUALSIASI DANNO O PERDITA DI DATI O ALTRE INFORMAZIONI MEMORIZZATI SU QUALSIASI SUPPORTO O QUALSIASI PARTE DI QUALSIASI PRODOTTO INVIATO A EIZO O I SUOI DISTRIBUTORI PER RIPARAZIONI.

EIZO E I SUOI DISTRIBUTORI NON OFFRONO ALCUNA GARANZIA ADDIZIONALE, IMPLICITA O ESPLICITA, RIGUARDO IL PRODOTTO E LA SUA QUALITÀ, PRESTAZIONI, VENDIBILITÀ O APPROPRIATEZZA PER QUALSIASI USO PARTICOLARE. IN NESSUN CASO EIZO O I DISTRIBUTORI EIZO AUTORIZZATI SARANNO RESPONSABILI PER QUALSIASI DANNO ACCIDENTALE, INDIRETTO, SPECIALE, CONSEGUENTE O DI QUALSIASI ALTRA NATURA (INCLUSI, SENZA LIMITI, DANNI PER PERDITA DI PROFITTI, INTERRUZIONE DELLE ATTIVITÀ, PERDITA DI INFORMAZIONI D’AFFARI O QUALSIASI ALTRA PERDITA PECUNIARIA) DERIVANTI DALL’USO O DALL’IMPOSSIBILITÀ DI USARE IL PRODOTTO O IN QUALSIASI RELAZIONE AL PRODOTTO, SIA SU BASE DI CONTRATTO, TORTO, NEGLIGENZA, STRETTA RESPONSABILITÀ O ALTRIMENTI, ANCHE SE EIZO O I DISTRIBUTORI EIZO AUTORIZZATI SONO STATI AVVERTITI DELLA POSSIBILITÀ DI TALI DANNI. QUESTA ESCLUSIONE INCLUDE ANCHE QUALSIASI RESPONSABILITÀ CHE POSSA INSORGERE DA RECLAMI DI TERZI CONTRO L’ACQUIRENTE ORIGINALE. L’ESSENZA DI QUESTO PROVVEDIMENTO È LIMITARE LA RESPONSABILITÀ POTENZIALE DI EIZO E DEI DISTRIBUTORI DERIVANTE DA QUESTA GARANZIA LIMITATA E/O DALLE VENDITE.

BEGRÄNSAD GARANTI

EIZO Corporation (nedan kallat **“EIZO”**) och EIZOs auktoriserade distributörer (nedan kallade **“Distributörer”**) garanterar i enlighet med villkoren i denna begränsade garanti (nedan kallad **“Garantin”**) den ursprungliga köparen (nedan kallad den **“Ursprunglige köparen”**) som köpte den i dokumentet specificerade produkten (nedan kallad **“Produkten”**) från EIZO eller Distributörer, att EIZO eller Distributörer enligt eget gottfinnande kostnadsfritt antingen reparera eller byta ut den defekta Produkten om den Ursprunglige köparen inom Garantiperioden (definieras nedan) upptäcker att Produkten fungerar felaktigt eller skadas under normal användning av Produkten i enlighet med beskrivningen i bruksanvisningen (nedan kallad **“Bruksanvisning”**).

Giltighetsperioden för denna garanti är begränsad till (i) fem (5) år från datumet för Produktens inköp eller, om detta inträffar tidigare, begränsat till utlöpanget av (ii) 30 000 timmars användning av Produkten (häri kallad **“Garantiperioden”**). Ljusstyrkan på produkten är emellertid endast garanterad om produkten har använts inom den rekommenderade ljusstyrka som beskrivs i Användarmanualen. Garantiperioden för ljusstyrkan är även begränsad till fem (5) år från produktens inköpsdatum såvida användningstiden är mindre än eller lika med 10 000 timmar. EIZO och Distributörer ska inte under några villkor ha något annat ansvar än vad som anges i denna garanti gällande Produkten i relation till den Ursprunglige köparen eller tredje part.

EIZO och Distributörer kommer att upphöra med lagerhållning av Produktens delar efter sju (7) år efter att produktionen av dessa delar upphört. Nät skärmen repareras använder EIZO och distributörer reservdelar som uppfyller våra kvalitetsstandarder.

Garantin är endast giltig i de länder där det finns Distributörer. Garantin begränsar inte några av den Ursprunglige köparens lagstadgade rättigheter.

Oavsett andra villkor i denna garanti ska inte EIZO Distributörer under några villkor ha något ansvar i något av de fall som beskrivs nedan:

- (a) När någon bristfällighet hos Produkten kan härledas till att ha uppstått vid frakt, modifiering, ändring, felaktigt handhavande, olycka, felaktig installation, katastrof, felaktigt underhåll och/eller felaktig reparation utförd av tredje part annan än EIZO och Distributörer.
- (b) Alla former av inkompatibilitet hos Produkten på grund av möjliga tekniska innovationer och/eller bestämmelser.
- (c) Alla försämringar av sensorn.
- (d) Alla försämringar av bildens prestanda beroende på förbrukningsdelar så som LCD-panel och/eller bakgrundsbelysning etc. (t.ex. ändringar i jämnhet i ljusstyrka, färg, färgjämnhet, defekta pixlar och/eller fast lysande pixlar etc.).
- (e) Alla försämringar av Produkten orsakat av användning av en högre ljusstyrka än den i Bruksanvisningen rekommenderade ljusstyrkan.
- (f) Alla defekter hos Produkten som orsakats av extern utrustning.
- (g) Alla defekter hos Produkten på vilken det ursprungliga serienumret har ändrats eller avlägsnats.
- (h) All normal försämring av Produkten, speciellt förbrukningsartiklar, tillbehör och/eller yttre delar (t.ex. knappar, roterande delar, kablar, Bruksanvisningen etc.).
- (i) Varje deformation, missfärgning och/eller skevhet av Produktens yttre inklusive ytan på LCD-panelen.

För att erhålla service under denna garanti måste den Ursprunglige köparen (med hänseende till risken för skada och/eller förlust under transport) leverera Produkten till närmaste Distributör med förebetalad frakt, i dess ursprungliga förpackning eller annan fullgod förpackning som ger likvärdigt skydd. Den Ursprunglige köparen måste kunna visa inköpsbevis för Produkten som klargör Produktens inköpsdatum vid begäran av garantiservice.

Garantiperioden för alla utbytta och/eller reparerade produkter under denna garanti skall upphöra vid utgången av den ursprungliga Garantiperioden.

EIZO ELLER DISTRIBUTÖRER ÄR INTE ANSVARIGA FÖR NÅGON FORM AV SKADA ELLER FÖRLUST AV DATA ELLER ANNAN INFORMATION SOM HAR LAGRATS I NÅGON FORM AV MEDIA ELLER ANNAN DEL AV NÅGON PRODUKT SOM HAR RETURNERATS TILL EIZO ELLER DISTRIBUTÖRER FÖR REPARATION.

EIZO OCH DISTRIBUTÖRERNA GARANTERAR INGET, UTTRYCKLIGEN ELLER UNDERFÖRSTÅTT, VAD BETRÄFFAR PRODUKTEN OCH DESS KVALITET, PRESTANDA, SÄLJBARHET ELLER LÄMPLIGHET FÖR NÅGON FORM AV SPECIELL ANVÄNDNING. UNDER INGA OMSTÄNDIGHETER SKALL EIZO ELLER DISTRIBUTÖRERNA HÅLLAS ANSVARIGA FÖR NÅGRA SOM HELST UNDERORDNADE, INDIREKTA, SPECIELLA, DÄRAV FÖLJANDE ELLER ÖVRIGA SKADOR (INKLUSIVE, UTAN BEGRÄNSNING TILL, SKADOR FÖR FÖRLUST AV INKOMST, AVBRUTEN AFFÄRSRÖRELSE, FÖRLUST AV AFFÄRSINFORMATION ELLER ANNAN SÄRSKILD FÖRLUST) SOM UPPSTÅTT SOM ETT RESULTAT AV ANVÄNDNING ELLER OFÖRMÅGA ATT ANVÄNDA PRODUKTEN ELLER I NÅGON FORM AV ANSLUTNING TILL PRODUKTERNA, VARE SIG DETTA GRUNDAS PÅ KONTRAKT, ÅTALBAR HANDLING, FÖRSUMLIGHET, ANSVARSSKYLDIGHET ELLER ANNAT, ÄVEN OM EIZO ELLER DISTRIBUTÖRERNA HAR INFORMERATS BETRÄFFANDE MÖJLIGHET ATT SÅDANA SKADOR FÖRELIGGER. DETTA UNDANTAG OMFATTAR ÄVEN ALL FORM AV ANSVARSSKYLDIGHET SOM KAN UPPSTÅ GENOM EN TREDJE PARTS ANSPRÅK GENTEMOT DEN URSPRUNGLIGE KÖPAREN. GRUNDBESTÄNDSDELEN I BESTÄMMELEN ÄR ATT BEGRÄNSA DET EVENTUELLA ANSVARSTAGANDET FÖR EIZO OCH DISTRIBUTÖRERNA SOM KAN UPPSTÅ GENOM DENNA BEGRÄNSADE GARANTI OCH/ELLER FÖRSÄLJNING.

ΠΕΡΙΟΡΙΣΜΕΝΗ ΕΓΓΥΗΣΗ

Η EIZO Corporation (στο εξής «**EIZO**») και οι διανομείς που εξουσιοδοτεί η EIZO (στο εξής «**Διανομείς**») παρέχουν εγγύηση, υποκείμενη και σύμφωνα με τους όρους της παρούσας περιορισμένης εγγύησης (στο εξής «**Εγγύηση**»), στον αρχικό αγοραστή (στο εξής «**Αρχικός Αγοραστής**») ο οποίος αγόρασε το προϊόν που καθορίζεται στο παρόν έγγραφο (στο εξής «**Προϊόν**») από την EIZO ή τους Διανομείς, η οποία εξασφαλίζει ότι η EIZO και οι Διανομείς, σύμφωνα με τη διακριτή ευχέρειά τους, είτε θα επισκευάσουν είτε θα αντικαταστήσουν το Προϊόν χωρίς χρέωση εάν ο Αρχικός Αγοραστής αντιληφθεί εντός της Περιόδου Εγγύησης (ορίζεται κατωτέρω) ότι το Προϊόν δυσλειτουργεί ή έχει υποστεί βλάβη κατά τη διάρκεια κανονικής χρήσης του Προϊόντος σύμφωνα με την περιγραφή στο εγχειρίδιο χρήσης που συνοδεύει το Προϊόν (στο εξής «**Εγχειρίδιο Χρήστη**»).

Η περίοδος της παρούσας Εγγύησης είναι (i) πέντε (5) έτη από την ημερομηνία αγοράς του Προϊόντος, ή, στη λήξη των (ii) 30.000 ωρών χρήσης του Προϊόντος (στο εξής «**Περίοδος Εγγύησης**»). Ωστόσο, η φωτεινότητα του Προϊόντος θα πρέπει να καλύπτεται από την εγγύηση μόνο αν το Προϊόν έχει χρησιμοποιηθεί στη συνιστώμενη φωτεινότητα που περιγράφεται στο Εγχειρίδιο χρήσης. Η Περίοδος Εγγύησης για τη φωτεινότητα περιορίζεται επίσης σε πέντε (5) χρόνια από την ημερομηνία αγοράς του Προϊόντος με την προϋπόθεση ότι ο χρόνος χρήσης είναι μικρότερος ή ίσος με 10.000 ώρες. Η EIZO και οι Διανομείς δεν φέρουν καμία ευθύνη ή υποχρέωση όσον αφορά το Προϊόν σε σχέση με τον Αρχικό Αγοραστή ή οποιοδήποτε τρίτο μέρος, ούτε άλλη ευθύνη διαφορετική από αυτήν που παρέχεται στην παρούσα Εγγύηση.

Η EIZO και οι Διανομείς θα παύσουν να διατηρούν ή να αποθηκεύουν τυχόν εξαρτήματα του Προϊόντος κατόπιν της λήξης των επτά (7) ετών μετά τη διακοπή της παραγωγής τέτοιων εξαρτημάτων. Κατά την επίσκεψή της οθόνης, η EIZO και οι Διανομείς θα χρησιμοποιήσουν ανταλλακτικά επισκευής που συμμορφώνονται με τα πρότυπά μας για τη Διασφάλιση Ποιότητας.

Η Εγγύηση ισχύει μόνο σε χώρες ή περιοχές όπου βρίσκονται οι Διανομείς. Η Εγγύηση δεν περιορίζει οποιαδήποτε νόμιμα δικαιώματα του Αρχικού Αγοραστή.

Λαμβανομένης υπόψη κάθε διάταξης της παρούσας Εγγύησης, η EIZO και οι Διανομείς δεν θα έχουν καμία απολύτως υποχρέωση σύμφωνα με την παρούσα Εγγύηση σε οποιαδήποτε από τις περιπτώσεις που διατυπώνονται κατωτέρω:

- (α) Τυχόν ελάττωμα του Προϊόντος που προκαλείται από ζημιά κατά τη μεταφορά, τροποποίηση, αλλαγή, κατάχρηση, λανθασμένη χρήση, ατύχημα, λανθασμένη εγκατάσταση, καταστροφή, εσφαλμένη συντήρηση ή/και λανθασμένη επίσκεψη από τρίτο μέρος εκτός της EIZO και των Διανομμένων,
- (β) Τυχόν ασυμβατότητα του Προϊόντος λόγω πιθανών τεχνικών καινοτομιών ή/και κανονισμών,
- (γ) Τυχόν επιδείνωση του αισθητήρα,
- (δ) Τυχόν επιδείνωση της απόδοσης οθόνης που προκαλείται από τη φθορά αναλώσιμων εξαρτημάτων όπως της οθόνης LCD ή/και του φωτός υποβάθρου, κτλ. (π.χ. αλλαγές στην ομοιομορφία φωτεινότητας, αλλαγές στο χρώμα, αλλαγές στην ομοιομορφία χρώματος, ελαττώματα σε pixel περιλαμβανομένων των καμένων pixel, κτλ.),
- (ε) Τυχόν επιδείνωση του Προϊόντος λόγω χρήσης σε υψηλότερη φωτεινότητα από τη συνιστώμενη φωτεινότητα που περιγράφεται στο Εγχειρίδιο Χρήστη,
- (στ) Τυχόν ελάττωμα του Προϊόντος που προκαλείται από εξωτερικό εξοπλισμό,
- (ζ) Τυχόν ελάττωμα του Προϊόντος στο οποίο έχει τροποποιηθεί ή αφαιρεθεί ο γνήσιος αριθμός σειράς,
- (η) Τυχόν φυσιολογική φθορά του προϊόντος, ιδιαίτερα αυτής των αναλώσιμων, των αξεσουάρ ή/και των προσαρτημάτων (π.χ. κουμπιά, περιστρεφόμενα μέρη, καλώδια, Εγχειρίδιο Χρήστη, κτλ.), και
- (θ) Τυχόν παραμόρφωση, αποχρωματισμό ή/και διαστρέβλωση του εξωτερικού μέρους του προϊόντος, περιλαμβανομένης της επιφάνειας της οθόνης LCD.

Ο Αρχικός Αγοραστής για να δικαιούται υπηρεσίες επισκευής σύμφωνα με την Εγγύηση, θα πρέπει να παραδώσει το Προϊόν, με πληρωμένα τα μεταφορικά έξοδα, στην αρχική του συσκευασία ή σε άλλη επαρκή συσκευασία με ισότιμο βαθμό προστασίας, αναλαμβάνοντας τον κίνδυνο βλάβης ή/και απώλειας κατά τη μεταφορά, στον τοπικό Διανομέα. Ο Αρχικός Αγοραστής όταν ζητά υπηρεσίες επισκευής σύμφωνα με την Εγγύηση, θα πρέπει να προσκομίζει την απόδειξη αγοράς του Προϊόντος και την ημερομηνία της αγοράς.

Η Περίοδος Εγγύησης για οποιοδήποτε αντικατεστημένο ή/και επισκευασμένο προϊόν σύμφωνα με την παρούσα Εγγύηση λήγει στο τέλος της αρχικής Περιόδου Εγγύησης.

Η EIZO Ή ΟΙ ΔΙΑΝΟΜΕΙΣ ΔΕΝ ΕΥΘΥΝΟΝΤΑΙ ΓΙΑ ΟΠΟΙΟΔΗΠΟΤΕ ΒΛΑΒΗ Ή ΑΠΩΛΕΙΑ ΔΕΔΟΜΕΝΩΝ Ή ΑΛΛΩΝ ΠΛΗΡΟΦΟΡΙΩΝ ΠΟΥ ΑΠΟΘΗΚΕΥΟΝΤΑΙ ΣΕ ΟΠΟΙΟΔΗΠΟΤΕ ΜΕΣΟ Ή ΟΠΟΙΟΔΗΠΟΤΕ ΑΛΛΟ ΜΕΡΟΣ ΣΕ ΟΠΟΙΟΔΗΠΟΤΕ ΠΡΟΪΟΝ ΠΟΥ ΕΠΙΣΤΡΕΦΕΤΑΙ ΣΤΗΝ EIZO Ή ΣΕ ΔΙΑΝΟΜΕΑ ΓΙΑ ΕΠΙΣΚΕΥΗ.

Η EIZO ΚΑΙ ΟΙ ΔΙΑΝΟΜΕΙΣ ΔΕΝ ΠΑΡΕΧΟΥΝ ΚΑΜΙΑ ΠΕΡΑΙΤΕΡΩ ΕΓΓΥΗΣΗ, ΡΗΤΗ Ή ΣΥΝΕΠΑΓΟΜΕΝΗ, ΟΣΟΝ ΑΦΟΡΑ ΤΟ ΠΡΟΪΟΝ ΚΑΙ ΤΗΝ ΠΟΙΟΤΗΤΑ, ΤΗΝ ΑΠΟΔΟΣΗ, ΤΗΝ ΕΜΠΟΡΕΥΣΙΜΟΤΗΤΑ Ή ΤΗΝ ΚΑΤΑΛΛΗΛΟΤΗΤΑ ΤΟΥ ΓΙΑ ΟΠΟΙΟΔΗΠΟΤΕ ΣΥΓΚΕΚΡΙΜΕΝΗ ΧΡΗΣΗ. ΣΕ ΚΑΜΙΑ ΠΕΡΙΠΤΩΣΗ Η EIZO Ή ΟΙ ΔΙΑΝΟΜΕΙΣ ΔΕΝ ΘΑ ΕΥΘΥΝΟΝΤΑΙ ΓΙΑ ΚΑΜΙΑ ΑΠΟΛΥΤΩΣ ΤΥΧΑΙΑ, ΕΜΜΕΣΗ, ΕΙΔΙΚΗ, ΣΥΝΕΠΑΓΟΜΕΝΗ Ή ΑΛΛΗ ΒΛΑΒΗ (ΠΕΡΙΛΑΜΒΑΝΟΜΕΝΩΝ, ΜΕΤΑΞΥ ΑΛΛΩΝ, ΒΛΑΒΩΝ Ή ΑΠΩΛΕΙΑΣ ΚΕΡΔΩΝ, ΔΙΑΚΟΠΗΣ ΕΠΙΧΕΙΡΗΜΑΤΙΚΩΝ ΔΡΑΣΤΗΡΙΟΤΗΤΩΝ, ΑΠΩΛΕΙΑΣ ΕΠΙΧΕΙΡΗΜΑΤΙΚΩΝ ΠΛΗΡΟΦΟΡΙΩΝ Ή ΤΥΧΟΝ ΑΛΛΗΣ ΧΡΗΜΑΤΙΚΗΣ ΑΠΩΛΕΙΑΣ) ΠΟΥ ΠΡΟΚΥΠΤΕΙ ΑΠΟ ΤΗ ΧΡΗΣΗ Ή ΤΗΝ ΑΝΙΚΑΝΟΤΗΤΑ ΧΡΗΣΗΣ ΤΟΥ ΠΡΟΪΟΝΤΟΣ Ή ΤΥΧΟΝ ΑΛΛΗΣ ΣΥΝΔΕΣΗΣ ΜΕ ΤΟ ΠΡΟΪΟΝ, ΕΙΤΕ ΒΑΣΙΖΕΤΑΙ ΣΕ ΣΥΜΒΟΛΑΙΟ, ΒΛΑΒΗ, ΑΜΕΛΕΙΑ, ΑΥΣΤΗΡΗ ΕΥΘΥΝΗ Ή ΕΙΔΑΛΛΩΣ, ΑΚΟΜΗ ΚΙ ΕΑΝ Η EIZO Ή ΟΙ ΔΙΑΝΟΜΕΙΣ ΕΝΗΜΕΡΩΘΟΥΝ ΓΙΑ ΤΗΝ ΠΙΘΑΝΟΤΗΤΑ ΤΕΤΟΙΩΝ ΖΗΜΙΩΝ. Η ΕΞΑΙΡΕΣΗ ΑΥΤΗ ΠΕΡΙΛΑΜΒΑΝΕΙ ΕΠΙΣΗΣ ΟΠΟΙΟΔΗΠΟΤΕ ΕΥΘΥΝΗ ΕΝΔΕΧΕΤΑΙ ΝΑ ΠΡΟΚΥΨΕΙ ΑΠΟ ΑΞΙΩΣΕΙΣ ΤΡΙΤΟΥ ΜΕΡΟΥΣ ΚΑΤΑ ΤΟΥ ΑΡΧΙΚΟΥ ΑΓΟΡΑΣΤΗ. Η ΟΥΣΙΑ ΤΟΥ ΟΡΟΥ ΑΥΤΟΥ ΕΙΝΑΙ ΝΑ ΠΕΡΙΟΡΙΣΕΙ ΤΗΝ ΠΙΘΑΝΗ ΕΥΘΥΝΗ ΤΗΣ EIZO ΚΑΙ ΤΩΝ ΔΙΑΝΟΜΕΩΝ ΠΟΥ ΠΡΟΚΥΠΤΕΙ ΑΠΟ ΤΗΝ ΠΑΡΟΥΣΑ ΕΓΓΥΗΣΗ Ή/ΚΑΙ ΤΙΣ ΠΩΛΗΣΕΙΣ.

ОГРАНИЧЕННАЯ ГАРАНТИЯ

EIZO Corporation (называемая в дальнейшем “EIZO”) и авторизованные EIZO дистрибуторы (называемые в дальнейшем “Дистрибуторы”) гарантируют, в соответствии с условиями и пунктами этой ограниченной гарантии (называемой в дальнейшем “Гарантия”), первичному покупателю (называемому в дальнейшем “Первоначальный покупатель”), который приобрел у EIZO или Дистрибуторов продукт, указанный в этом документе (называемый в дальнейшем “Продукт”), что EIZO или Дистрибуторы на свое усмотрение либо бесплатно отремонтируют, либо бесплатно заменят Продукт, если Первоначальный покупатель признает в пределах Гарантийного срока (определенного ниже), что Продукт неисправен или он поврежден процессе нормального использования продукта в соответствии с описанием в инструкции по эксплуатации, прилагаемой к Продукту (называемой в дальнейшем “Руководство пользователя”).

Гарантийный период ограничен сроком (i) пять (5) лет от даты приобретения Продукта или ограничен сроком (ii) 30 000 часов использования Продукта (называемый в дальнейшем “Гарантийный период”). Однако яркость Продукта может быть гарантирована только, если Продукт использовался с рекомендованной яркостью, указанной в Руководстве Пользователя. Гарантийный период для яркости также ограничен сроком пять (5) лет от даты приобретения Продукта и время его использования не превышает 10 000 часов. EIZO и Дистрибуторы не несут никакой ответственности и не берут обязательств относительно Продукта по отношению к Первоначальному покупателю или по отношению к любым третьим сторонам, кроме обязательств, оговоренных в этой Гарантии.

EIZO и Дистрибуторы прекратят хранение или складирование любых деталей Продукта по истечении семи (7) лет после прекращения производства таких деталей. В случае ремонта монитора EIZO и Дистрибуторы будут использовать запчасти, которые соответствуют нашим стандартам QC (контроль качества).

Гарантия действительна только в странах или регионах, где расположены Дистрибуторы. Гарантия не ограничивает никакие законные права Первоначального покупателя.

Несмотря на другие условия этой Гарантии EIZO и Дистрибуторы не несут никаких обязательств согласно этой Гарантии в любом из перечисленных ниже случаев:

- (а) Любые дефекты Продукта, вызванные повреждениями при перевозке, модификацией, изменением, неправильным обращением, неправильным использованием, авариями, неправильной установкой, стихийными бедствиями, неправильным уходом и/или неправильным ремонтом третьей стороной, отличной от EIZO или Дистрибуторов;
- (б) Любые несовместимости Продукта из-за технических усовершенствований и/или изменения технических норм;
- (в) Любое повреждение датчика;
- (г) Любые ухудшения работы дисплея, вызванные изнашиванием невосстановимых частей, таких как панель ЖКД и/или подсветка и т.д. (например, изменение в равномерности яркости, изменение в цветности, изменение в равномерности цветности, изменение в пикселях, включая выгоревшие пиксели и т.д.);
- (д) Любые ухудшения Продукта, вызванные использованием при яркости, повышенной по сравнению с рекомендованной яркостью, описанной в Руководстве пользователя;
- (е) Любые дефекты Продукта, вызванные внешним оборудованием;
- (ж) Любые дефекты Продукта, при которых оригинальный серийный номер был изменен или удален;
- (з) Любые естественные ухудшения продукта, в частности, вызванные износом расходных частей, принадлежностей и/или приспособлений (например, кнопок, вращающихся частей, кабелей, Руководства пользователя и т.д.); и
- (и) Любые деформации, изменения цвета и/или коробления внешней поверхности продукта, включая поверхность панели ЖКД.

Чтобы получить техническое обслуживание в рамках Гарантии, Первоначальный покупатель должен доставить Продукт местному Дистрибутору, оплатив перевозку, в его оригинальной упаковке или в другой соответствующей упаковке, обеспечивающей равноценную степень защиты, принимая во внимание риск повреждения и/или утерю при транспортировке. При запросе технического обслуживания в рамках Гарантии Первоначальный покупатель должен предоставить свидетельство покупки продукта и даты покупки.

Гарантийный период для любого замененного и/или отремонтированного продукта в рамках Гарантии истекает в конце завершения срока действия оригинального Гарантийного периода.

EIZO ИЛИ ДИСТРИБУТОРЫ НЕ НЕСУТ ОТВЕТСТВЕННОСТИ ЗА ЛЮБЫЕ ПОВРЕЖДЕНИЯ ИЛИ УТЕРЮ ДАННЫХ ИЛИ ДРУГОЙ ИНФОРМАЦИИ, ХРАНЯЩИХСЯ НА КАКИХ-ЛИБО НОСИТЕЛЯХ ИНФОРМАЦИИ ИЛИ НА ЛЮБЫХ ДРУГИХ ЧАСТЯХ ПРОДУКТА, КОТОРЫЙ ВОЗВРАЩЕН EIZO ИЛИ ДИСТРИБУТОРАМ ДЛЯ РЕМОНТА.

EIZO и ДИСТРИБУТОРЫ НЕ ДАЮТ НИКАКОЙ ДАЛЬНЕЙШЕЙ ГАРАНТИИ, ВЫРАЖЕННОЙ ИЛИ ПОДРАЗУМЕВАЕМОЙ, ОТНОСИТЕЛЬНО ПРОДУКТА И ЕГО КАЧЕСТВА, ТЕХНИЧЕСКИХ ХАРАКТЕРИСТИК, ТОВАРНОСТИ ИЛИ СООТВЕТСТВИЯ ДЛЯ КАКОГО-ЛИБО ОПРЕДЕЛЕННОГО ИСПОЛЬЗОВАНИЯ. НИ ПРИ КАКИХ УСЛОВИЯХ EIZO ИЛИ ДИСТРИБУТОРЫ НЕ НЕСУТ ОТВЕТСТВЕННОСТИ ЗА ЛЮБОЙ СЛУЧАЙНЫЙ, КОСВЕННЫЙ, СПЕЦИАЛЬНЫЙ, ПОБОЧНЫЙ ИЛИ ИНОЙ УЩЕРБ (ВКЛЮЧАЯ, БЕЗ ОГРАНИЧЕНИЙ, УЩЕРБ ИЗ-ЗА НЕПОЛУЧЕННОЙ ПРИБЫЛИ, ПРЕРЫВАНИЯ БИЗНЕСА, ПОТЕРИ КОММЕРЧЕСКОЙ ИНФОРМАЦИИ ИЛИ ЛЮБЫЕ ДРУГИЕ ФИНАНСОВЫЕ ПОТЕРИ), ВОЗНИКШИЙ ИЗ-ЗА ИСПОЛЬЗОВАНИЯ ИЛИ НЕВОЗМОЖНОСТИ ИСПОЛЬЗОВАТЬ ПРОДУКТ ИЛИ В ЛЮБОЙ ДРУГОЙ СВЯЗИ С ПРОДУКТОМ, ЛИБО ОСНОВАННЫЙ НА КОНТРАКТНЫХ ОТНОШЕНИЯХ, ГРАЖДАНСКИХ ПРАВОНАРУШЕНИЯХ, НЕБРЕЖНОСТИ, ПРИЧИНИЕНИЯ УЩЕРБА ТРЕТЬЕЙ СТОРОНЕ ИЛИ ЧЕМ-ЛИБО ЕЩЕ, ДАЖЕ ЕСЛИ EIZO ИЛИ ДИСТРИБУТОРЫ БЫЛИ УВЕДОМЛЕННЫ О ВОЗМОЖНОСТИ ТАКОГО УЩЕРБА. ЭТО ИСКЛЮЧЕНИЕ ТАКЖЕ ВКЛЮЧАЕТ ЛЮБЫЕ ОБЯЗАТЕЛЬСТВА, КОТОРЫЕ МОГУТ ВОЗНИКНУТЬ В РЕЗУЛЬТАТЕ ТРЕБОВАНИЙ ТРЕТЬЕЙ СТОРОНЫ В ОТНОШЕНИИ ПЕРВОНАЧАЛЬНОГО ПОКУПАТЕЛЯ. СУЩЕСТВОМ ЭТОГО ПОЛОЖЕНИЯ ЯВЛЯЕТСЯ ОГРАНИЧЕНИЕ ПОТЕНЦИАЛЬНОЙ ОТВЕТСТВЕННОСТИ EIZO И ДИСТРИБУТОРОВ, ВОЗНИКАЮЩЕЙ ИЗ-ЗА ЭТОЙ ОГРАНИЧЕННОЙ ГАРАНТИИ И/ЛИ ПРОДАЖ.

有限责任保证书

EIZO Corporation (以下简称“EIZO”)和 EIZO 授权的经销商 (以下简称“经销商”), 接受并依照本有限责任保证书 (以下简称“保证书”)之条款, 向从 EIZO 和经销商购买本文中规定产品 (以下简称“产品”)的原买方 (以下称“原买方”)提供保证:在保证期内 (规定如下), 如果原买方发现按本产品所附使用说明书 (以下简称“用户手册”)所述方式正常使用本产品过程中, 本产品出现故障或损坏, EIZO 和经销商根据其独立的判断免费修理或更换该产品。

本保证期限定为 (i) 自本产品购买之日起的五 (5) 年期间或限定为到达 (ii) 使用本产品 3 万小时的期限 (以下简称“保证期限”)。但是, 仅按照用户手册所描述的推荐亮度使用本产品时方对产品的亮度提供保证。亮度的保证期限也限定为本产品的使用时间在 10000 小时以下 (含 10000 小时) 的条件下自购买本产品之日起的五 (5) 年。EIZO 和经销商将不向原买方或任何第三方承担本保证书所规定之外的与本产品有关的任何责任或义务。

本产品的任何部件停产七 (7) 年后, EIZO 和经销商将不再保留或保管任何这类部件。维修显示器时, EIZO 与经销商将使用符合我方质量控制标准的替换零件。

本保证书仅对于设有经销商的国家或地区有效。本保证书并不限定原买方的任何法律权利。

无论本保证书的任何其他条款如何规定, 对于任何下列情况之一, EIZO 和经销商将不承担本保证书规定责任:

- (a) 由于运输损害、改装、改动、滥用、误用、意外事故、错误安装、灾害、维护不善和 / 或由除 EIZO 和经销商以外的第三方进行不适当的修理造成本产品的任何故障。
- (b) 由于可能发生的技术变更和 / 或调整造成本产品的任何不兼容性。
- (c) 传感器的任何劣化。
- (d) 由于诸如液晶显示屏 (LCD) 和 / 或背灯等消耗品部件的老化造成的任何显示性能低劣 (如亮度均一性变化、色彩变化、色彩均一性变化、如烧伤像素等像素缺陷)。
- (e) 由于在比用户手册所推荐亮度更高的亮度下使用对本产品所造成的任何老化。
- (f) 因外部设备造成本产品的任何故障。
- (g) 因本产品的原序号被改变或消除造成本产品的任何故障。
- (h) 本产品的任何正常老化, 尤其是消耗品、附件和 / 或附加装置 (如按钮、旋转部件、电缆、用户手册等)、以及
- (i) 本产品表面包括液晶显示屏 (LCD) 表面的任何变形、变色和 / 翘曲。

为了获得本保证书规定的服务, 原买方必须使用原包装或其他具有同等保护程度的适当包装将本产品运送到当地的经销商, 并且预付运费, 承担运输中的损坏和 / 或损失的风险。要求提供本保证书规定的服务时, 原买方必须提交购买本产品和标明此购买日期的证明。

按本保证书规定进行了更换和 / 或修理的任何产品的保证期限, 将在原保证期限结束时终止。

在返回给 EIZO 和经销商进行修理后, 任何产品的任何媒体或任何部件中储存的数据或其他信息发生任何损坏或损失, 对此 EIZO 和经销商将不承担责任。

对于本产品及其质量、性能、可销售性以及对于特殊用途的适合性, EIZO 和经销商不提供其他任何明示或暗示的保证。因使用本产品或无法使用本产品或因与本产品有任何关系 (无论是否根据合同) 而造成:任何附带的、间接的、特殊的、随之发生的或其他的损害 (包括但不限于:利润损失、业务中断、业务信息丢失或其他任何金钱损失) 以及侵权行为、过失、严格赔偿责任或其他责任, 即使已经向 EIZO 和经销商提出了发生这些损害的可能性, 对此 EIZO 和经销商概不承担责任。本免责条款还包括因第三方向原买方提出索赔而可能发生的任何责任。本条款的本质是限定由于本有限责任保证书和 / 或销售本产品所发生的 EIZO 和经销商的潜在责任。

Recycling Information

Recycling Information

This product, when disposed of, is supposed to be collected and recycled according to your country's legislation to reduce environmental burden. When you dispose of this product, please contact a distributor or an affiliate in your country.

The contact addressees are listed on the EIZO website below.

<http://www.eizoglobal.com>

For recycling information for customers in Switzerland, please refer to the following website.

<http://www.swico.ch>

Informationen zum Thema Recycling

Dieses Produkt muss gemäß den Vorschriften Ihres Landes zur Entlastung der Umwelt recyclet werden. Wenden Sie sich bei der Entsorgung dieses Produkts an einen Verteiler oder eine Tochtergesellschaft in Ihrem Land.

Die Adressen zur Kontaktaufnahme sind auf der unten angegebenen Website von EIZO aufgeführt.

<http://www.eizoglobal.com>

Kunden in der Schweiz entnehmen Informationen zum Recycling der folgenden Website:

<http://www.swico.ch>

Informations sur le recyclage

Ce produit doit être jeté aux points de collecte prévus à cet effet et recyclé conformément à la législation de votre pays, afin de réduire l'impact sur l'environnement. Lorsque vous jetez ce produit, veuillez contacter un distributeur ou une société affiliée de votre pays.

Les adresses des distributeurs sont répertoriées sur le site Web EIZO ci-dessous.

<http://www.eizoglobal.com>

Pour les clients en Suisse, veuillez consulter le site Web suivant afin d'obtenir des informations sur le recyclage.

<http://www.swico.ch>

Información sobre reciclaje

Este producto debe desecharse y reciclarse según la legislación del país para reducir el impacto medioambiental. Cuando desee deshacerse de este producto, póngase en contacto con un distribuidor o una filial de su país.

Encontrará las direcciones de contacto en el sitio web de EIZO que se indica a continuación.

<http://www.eizoglobal.com>

Informazioni sul riciclaggio

Per lo smaltimento e il riciclaggio del presente prodotto, attenersi alle normative vigenti nel proprio paese per ridurre l'impatto ambientale. Per lo smaltimento, rivolgersi ad un distributore o un affiliato presenti nel proprio paese.

Gli indirizzi sono elencati nel sito Web EIZO riportato di seguito.

<http://www.eizoglobal.com>

Per informazioni sul riciclaggio per i clienti in Svizzera, consultare il sito Web riportato di seguito.

<http://www.swico.ch>

Återvinningsinformation

När denna produkt kasseras ska den hanteras och återvinnas enligt landets föreskrifter för att reducera miljöpåverkan. När du kasserar produkten ska du kontakta en distributör eller representant i ditt land.

Kontaktadresserna listas på EIZO-webbplatsen nedan.

<http://www.eizoglobal.com>

Πληροφορίες ανακύκλωσης

Το προϊόν αυτό, όταν απορρίπτεται, πρέπει να συλλέγεται και να ανακυκλώνεται σύμφωνα με τη νομοθεσία της χώρας σας έτσι ώστε να μην επιβαρύνει το περιβάλλον. Για να απορρίψετε το προϊόν, επικοινωνήστε με έναν αντιπρόσωπο ή μια θυγατρική εταιρεία στη χώρα σας.

Οι διευθύνσεις επικοινωνίας αναγράφονται στην τοποθεσία web της EIZO παρακάτω.

<http://www.eizoglobal.com>

Сведения по утилизации

По истечении срока службы данного продукта его следует принести на сборный пункт и утилизировать в соответствии с действующими предписаниями в вашей стране, чтобы уменьшить вредное воздействие на окружающую среду. Прежде чем выбросить данный продукт, обратитесь к дистрибьютору или в местное представительство компании в вашей стране.

Контактные адреса можно найти на веб-узле EIZO.

<http://www.eizoglobal.com>

Informatie over recycling

Wanneer u dit product wilt weggoien, moet het uit milieu-overwegingen worden verzameld en gerecycled volgens de betreffende wetgeving van uw land. Wanneer u dit product wilt weggoien, moet u contact opnemen met een distributeur of een partner in uw land.

De contactadressen worden vermeld op de volgende EIZO-website.

<http://www.eizoglobal.com>

Informação sobre reciclagem

Este produto, quando o deitar fora, deve ser recolhido e reciclado de acordo com a legislação do seu país para reduzir a poluição. Quando deitar fora este produto, contacte um distribuidor ou uma filial no seu país.

Os endereços de contacto estão listados no website do EIZO, abaixo.

<http://www.eizoglobal.com>

Oplysninger om genbrug

Dette produkt forventes ved bortskaffelse at blive indsamlet og genbrugt i overensstemmelse med lovgivningen i dit land for at reducere belastningen af miljøet. Når du bortskaffer denne produkt, skal du kontakte en distributør eller et tilknyttet selskab i dit land.

Adresserne på kontaktpersonerne er angivet på EIZO's websted nedenfor.

<http://www.eizoglobal.com>

Kierrätystä koskevia tietoja

Tuote tulee hävittää kierrättämällä maan lainsäädännön mukaisesti ympäristön kuormittumisen vähentämiseksi. Kun hävität tuotteen, ota yhteyttä jälleenmyyjään tai tytäryhtiöön maassasi.

Yhteystiedot löytyvät EIZOn Internet-sivustolta.

<http://www.eizoglobal.com>

Wykorzystanie surowców wtórnych

Ten produkt po zużyciu powinien być zbierany i przetwarzany zgodnie z krajowymi przepisami dotyczącymi ochrony środowiska. Wyrzucając ten produkt, należy skontaktować się z lokalnym dystrybutorem lub partnerem. Adresy kontaktowe można znaleźć we wskazanej poniżej witrynie internetowej firmy EIZO.

<http://www.eizoglobal.com>

Informace o recyklaci

Při likvidaci produktu musí být produkt vyzvednut a recyklován podle zákonů příslušné země, aby nedocházelo k zatěžování životního prostředí. Zbavujete-li se produktu, kontaktujte distributora nebo pobočku ve své zemi. Kontaktní adresy jsou uvedeny na následující webové stránce společnosti EIZO.

<http://www.eizoglobal.com>

Ringlussevõtu alane teave

Keskkonnakoormuse vähendamiseks tuleks kasutatud tooted kokku koguda ja võtta ringlusse vastavalt teie riigi seadustele. Kui kõrvaldate käesoleva toote, võtke palun ühendust turustaja või filiaaliga oma riigis.

Kontaktisikud on toodud EIZO veebilehel järgmisel aadressil:

<http://www.eizoglobal.com>

Újrahasznosítási információ

Jelen terméket, amikor eldobjuk, az illető ország törvényei alapján kell összegyűjteni és újrahasznosítani, hogy csökkentsük a környezet terhelését. Amikor ezt a terméket eldobja, kérjük lépjen kapcsolatba egy országon belüli forgalmazóval vagy társvállalkozással.

A kapcsolat címei az EIZO alábbi weboldalán található felsorolva:

<http://www.eizoglobal.com>

Podatki o recikliranju

Ob koncu uporabe odslužen izdelek izročite na zbirno mesto za recikliranje v skladu z okoljevarstveno zakonodajo vaše države. Prosim, da se pri odstranjevanju izdelka obrnete na lokalnega distributerja ali podružnico.

Kontaktne naslovi so objavljeni na spodaj navedenih spletnih straneh EIZO:

<http://www.eizoglobal.com>

Informácie o recyklácii

Pri likvidácii musí byť tento výrobok recyklovaný v súlade s legislatívou vašej krajiny, aby sa znížilo zaťaženie životného prostredia. Keď sa chcete zbaviť tohto výrobku, kontaktujte prosím distribútora alebo pobočku vo vašej krajine.

Zoznam kontaktných adries je uvedený na nasledovnej webovej stránke firmy EIZO:

<http://www.eizoglobal.com>

Pārstrādes informācija

Utilizējot šo produktu, tā savākšana un pārstrāde veicama atbilstoši jūsu valsts likumdošanas prasībām attiecībā uz slodzes uz vidi samazināšanu. Lai veiktu šī produkta utilizāciju, sazinieties ar izplatītāju vai pārstāvniecību jūsu valstī.

Kontaktadresses ir norādītas zemāk minētajā EIZO tīmekļa vietnē.

<http://www.eizoglobal.com>

Informacija apie grąžinamąjį perdirbimą

Šalinant (išmetant) šiuos gaminius juos reikia surinkti ir perdirbti grąžinamuoju būdu pagal jūsų šalies teisės aktus, siekiant sumažinti aplinkos teršimą. Kai reikia išmesti šį gaminį, kreipkitės į jūsų šalyje veikiančią gaminių pardavimo atstovybę arba jos filialą.

Kontaktiniai adresatai nurodyti EIZO interneto svetainėje.

<http://www.eizoglobal.com>

Информация относно рециклиране

При изхвърлянето на този продукт се предлага събирането и рециклирането му съобразно законите на вашата страна за да се намали замърсяването на околната среда. Когато искате да се освободите от този продукт, моля свържете се с търговския му представител или със съответните органи отговарящи за това във вашата страна.

Данните за връзка с нас са описани на следния Интернет сайт на EIZO:

<http://www.eizoglobal.com>

Informație referitoare la reciclare

Acest produs, când debarasat, trebuie colectat și reciclat conform legislației țării respective ca să reducem sarcina mediului. Când se debarasează de acest produs, vă rugăm să contactați un distribuitor sau un afiliat al țării respective.

Adresele de contact le găsiți pe pagina de web al EIZO:

<http://www.eizoglobal.com>

معلومات عن إعادة التدوير

عند التخلص من هذا المنتج، من الضروري تجميعه وإعادة تدويره وفقاً للقوانين المتبعة في بلدك لتقليل العبء المسلط على البيئة. عندما تتخلص من هذا المنتج، يرجى الاتصال بموزع أو طرف منتسب إليه في بلدك. عناوين الاتصال مدرجة في موقع ايزو EIZO ادناه على شبكة الانترنت.

<http://www.eizoglobal.com>

Geri Dönüşüm Bilgisi

Bu ürünün, atılacağı zaman, ülkenizin çevre kirliliğinin azaltılması konusundaki mevzuatına göre toplanması ve yeniden değerlendirilmesi gerekmektedir. Ürünü atacağınız zaman lütfen ülkenizdeki bir distribütör veya ilgili kuruluşla temasa geçiniz.

İrtibat adresleri aşağıdaki EIZO web sitesinde verilmiştir.

<http://www.eizoglobal.com>

China Measures for RoHS Compliance in ChinaRoHS

关于电子信息产品污染控制标识



本标识根据「电子信息产品污染控制管理办法」，适用于在中华人民共和国销售的电子信息产品。标识中央的数字为环保使用期限的年数。只要您遵守该产品相关的安全及使用注意事项，在自制造日起算的年限内，不会产生对环境污染或人体及财产的影响。上述标识粘贴在机器背面。

• 有毒有害物质或元素的名称及含量

部件名称	有毒有害物质或元素					
	铅 (Pb)	汞 (Hg)	镉 (Cd)	六价铬 (Cr (VI))	多溴联苯 (PBB)	多溴二苯醚 (PBDE)
印刷电路板	×	○	○	○	○	○
机箱	○	○	○	○	○	○
液晶显示器	×	○	○	○	○	○
其他	×	○	○	○	○	○

○：表示该有毒有害物质在该部件所有均质材料中的含量均在 SJ/T 11363-2006 规定的限量要求以下。
 ×：表示该有毒有害物质至少在该部件的某一均质材料中的含量超出 SJ/T 11363-2006 规定的限量要求。
 (企业可在此处,根据实际情况对上表中打“×”的技术原因进行进一步说明)

