

Large Format Display

User's Manual

MultiSync X555UNS

MultiSync X555UNV

MultiSync UN551S

MultiSync UN551VS

Index

Declaration of conformity.....	English-1
Important Information	English-2
WARNING.....	English-2
CAUTION.....	English-2
Safety Precautions, Maintenance & Recommended Use.....	English-3
Safety Precautions and Maintenance	English-3
Recommended Use	English-3
Ergonomics.....	English-3
Cleaning the LCD Panel	English-3
Cleaning the Cabinet	English-3
Contents	English-4
Installation	English-5
Attaching Mounting Accessories	English-6
Parts Name and Functions	English-8
Control Panel	English-8
Terminal Panel	English-9
Wireless Remote Control (Optional)	English-10
Operating Range for the Optional Remote Control.....	English-11
Setup	English-12
Connections	English-14
Wiring Diagram	English-14
Connecting a Personal Computer.....	English-15
Connecting a DVD Player or Computer with HDMI out	English-15
Connecting a Computer with DisplayPort	English-15
Basic Operation.....	English-16
Power ON and OFF Modes	English-16
Power Indicator.....	English-17
Initial settings.....	English-17
Using Power Management	English-17
Selecting a video source.....	English-17
Picture Aspect.....	English-17
Information OSD.....	English-18
Picture Mode.....	English-18
OSD (On-Screen-Display) Controls.....	English-19
PICTURE	English-20
ADJUST	English-20
AUDIO	English-21
SCHEDULE	English-22
PIP	English-22
OSD	English-23
MULTI DISPLAY	English-24
DISPLAY PROTECTION	English-26
EXTERNAL CONTROL.....	English-27
ADVANCED OPTION1	English-27
ADVANCED OPTION2	English-30
Remote Control Function.....	English-32
Multiple Monitors Connection	English-33
Controlling the LCD monitor via RS-232C Remote Control.....	English-34
Controlling the LCD monitor via LAN Control	English-36
Connecting to a Network	English-36
Network Setting by Using an HTTP Browser	English-36
POINT ZOOM.....	English-45
PROOF OF PLAY.....	English-45
INTELLIGENT WIRELESS DATA.....	English-46
Features	English-47
Troubleshooting.....	English-48
Specifications - X555UNS	English-49
Specifications - X555UNV	English-50
Specifications - UN551S	English-51
Specifications - UN551VS	English-52
Pin Assignment.....	English-53
PIP (Picture in Picture) matrix	English-53
Manufacturer's Recycling and Energy Information.....	English-54

Declaration of conformity

FCC Information

1. Use the attached specified cables with this display so as not to interfere with radio and television reception.
 - (1) Please use the supplied power cord or equivalent to ensure FCC compliance.
 - (2) Please use a good quality shielded video signal cable.Use of other cables and adapters may cause interference with radio and television reception.
2. This equipment has been tested and found to comply with the limits for a class A digital device, pursuant to Part 15 of the FCC Rules. These limits are designed to provide reasonable protection against harmful interference when the equipment is operated in a commercial environment. This equipment generates, uses, and can radiate radio frequency energy and, if not installed and used in accordance with the instruction manual, may cause harmful interference to radio communications. Operation of this equipment in a residential area is likely to cause harmful interference in which case the user will be required to correct the interference at his own expense.

If necessary, the user should contact the dealer or an experienced radio/television technician for additional suggestions. The user may find the following booklet, prepared by the Federal Communications Commission, helpful: "How to Identify and Resolve Radio-TV Interference Problems." This booklet is available from the U.S. Government Printing Office, Washington, D.C., 20402, Stock No. 004-000-00345-4.

Windows is a registered trademark of Microsoft Corporation.

NEC is a registered trademark of NEC Corporation.

OmniColor is a registered trademark of NEC Display Solutions Europe GmbH in the countries of EU and Switzerland.

DisplayPort and DisplayPort Compliance Logo are trademarks owned by the Video Electronics Standards Association in the United States and other countries.

All other brands and product names are trademarks or registered trademarks of their respective owners.



The terms HDMI and HDMI High-Definition Multimedia Interface and the HDMI Logo are trademarks or registered trademarks of HDMI Licensing LLC in the United States and other countries.

Trademark PJLink is a trademark applied for trademark rights in Japan, the United States of America and other countries and areas.

CRESTRON and ROOMVIEW are registered trademarks of Crestron Electronics, Inc. in the United States and other countries.





GPL/LGPL Software Licenses

The product includes software licensed under GNU General Public License (GPL), GNU Lesser General Public License (LGPL), and others.

For more information on each software, see "readme.pdf" inside the "about GPL&LGPL" folder on the supplied CD-ROM.

Important Information

	WARNING	
<p>TO PREVENT FIRE OR SHOCK HAZARDS, DO NOT EXPOSE THIS UNIT TO RAIN OR MOISTURE. ALSO, DO NOT USE THIS UNIT'S POLARIZED PLUG WITH AN EXTENSION CORD RECEPTACLE OR OTHER OUTLETS UNLESS THE PRONGS CAN BE FULLY INSERTED.</p> <p>REFRAIN FROM OPENING THE CABINET AS THERE ARE HIGH VOLTAGE COMPONENTS INSIDE. REFER SERVICING TO QUALIFIED SERVICE PERSONNEL.</p>		

	CAUTION	
<p>CAUTION: TO REDUCE THE RISK OF ELECTRIC SHOCK, MAKE SURE POWER CORD IS UNPLUGGED FROM WALL SOCKET. TO FULLY DISENGAGE THE POWER TO THE UNIT, PLEASE DISCONNECT THE POWER CORD FROM THE AC OUTLET. DO NOT REMOVE COVER (OR BACK). NO USER SERVICEABLE PARTS INSIDE. REFER SERVICING TO QUALIFIED SERVICE PERSONNEL.</p>		
	<p>This symbol warns user that uninsulated voltage within the unit may have sufficient magnitude to cause electric shock. Therefore, it is dangerous to make any kind of contact with any part inside this unit.</p>	
	<p>This symbol alerts the user that important literature concerning the operation and maintenance of this unit has been included. Therefore, it should be read carefully in order to avoid any problems.</p>	

CAUTION: Please use the power cord provided with this monitor in accordance with the table below. If a power cord is not supplied with this equipment, please contact your supplier. For all other cases, please use a power cord that matches the AC voltage of the power outlet and has been approved by and complies with the safety standard of your particular country.

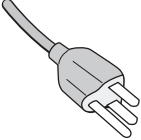
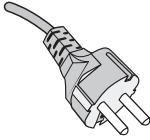
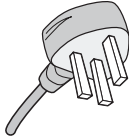
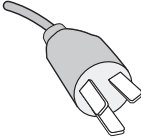
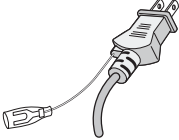
Plug Type	North America		European Continental	U.K.	Chinese	Japanese
Plug Shape						
Region	U.S.A./ Canada	Taiwan	EU (except U.K.)	U.K.	China	Japan
Voltage	120*	110	230	230	220	100

* When operating the MultiSync monitor with its AC 125-240V power supply, use a power supply cord that matches the power supply voltage of the AC power outlet being used.

NOTE: This product can only be serviced in the country where it was purchased.
Use the power cord which has BSMI mark at both ends when you use this monitor in Taiwan.

- The intended primary use of this product is as an Information Technical Equipment in an office or domestic environment.
- The product is intended to be connected to a computer and is not intended for the display of television broadcast signals.

Warning

This is a class A product. In a domestic environment this product may cause radio interference in which case the user may be required to take adequate measures.



Safety Precautions, Maintenance & Recommended Use

FOR OPTIMUM PERFORMANCE, PLEASE NOTE THE FOLLOWING WHEN SETTING UP AND USING THE MULTI-FUNCTION MONITOR:

- **DO NOT OPEN THE MONITOR.** There are no user serviceable parts inside and opening or removing covers may expose you to dangerous shock hazards or other risks. Refer all servicing to qualified service personnel.
- Do not spill any liquids into the cabinet or use your monitor near water.
- Do not insert objects of any kind into the cabinet slots, as they may touch dangerous voltage points, which can be harmful or fatal or may cause electric shock, fire or equipment failure.
- Do not place any heavy objects on the power cord. Damage to the cord may cause shock or fire.
- Do not place this product on a sloping or unstable cart, stand or table, as the monitor may fall, causing serious damage to the monitor.
- Do not mount this product face up, face down or upside down for an extended period of time as it may cause permanent damage to the screen.
- The power supply cord you use must have been approved by and comply with the safety standards of your country. (Type H05VV-F 3G 1mm² should be used in Europe)
- In UK, use a BS-approved power cord with molded plug having a black (13A) fuse installed for use with this monitor.
- Do not place any objects onto the monitor and do not use the monitor outdoors.
- Do not bend, crimp or otherwise damage the power cord.
- If glass is broken, handle with care.
- Do not cover vent on monitor.
- Do not use monitor in high temperature, humid, dusty, or oily areas.
- If monitor or glass is broken, do not come in contact with the liquid crystal and handle with care.
- Allow adequate ventilation around the monitor, so that heat can properly dissipate. Do not block ventilated openings or place the monitor near a radiator or other heat sources. Do not put anything on top of the monitor.
- The power cable connector is the primary means of detaching the system from the power supply. The monitor should be installed close to a power outlet, which is easily accessible.
- Do not move or mount this product by hanging a rope or wire to the backside handle. Do not mount or secure this product by using the backside handle. It may fall and cause personal injury.
- Handle with care when transporting. Save packaging for transporting.
- If using the cooling fan continuously, it is recommended to wipe holes clean a minimum of once a month.
- Please clean the holes of back cabinet to reject dirt and dust at least once a year because of set reliability.
- When using a LAN cable, do not connect to a peripheral device with wiring that might have excessive voltage.
- Do not use monitor under rapid temperature and humidity change condition or avoid cold air from air-conditioning outlet directly, as it may shorten the lifetime of the monitor or cause condensation. If condensation happens, let the monitor stand unplugged until there is no condensation.

Connecting to a TV*

- Cable distribution system should be grounded (earthed) in accordance with ANSI/NFPA 70, the National Electrical Code (NEC), in particular Section 820.93, Grounding of Outer Conductive Shield of a Coaxial Cable.
- The screen of the coaxial cable is intended to be connected to earth in the building installation.

Immediately unplug your monitor from the wall outlet and refer servicing to qualified service personnel under the following conditions:

- When the power supply cord or plug is damaged.
- If liquid has been spilled, or objects have fallen into the monitor.
- If the monitor has been exposed to rain or water.
- If the monitor has been dropped or the cabinet damaged.
- If you notice any structural damage such as cracks or unnatural wobbling.
- If the monitor does not operate normally by following operating instructions.

Recommended Use

- For optimum performance, allow 20 minutes for warm-up.
- Rest your eyes periodically by focusing on an object at least 5 feet away. Blink often.
- Position the monitor at a 90° angle to windows and other light sources to minimize glare and reflections.
- Clean the LCD monitor surface with a lint-free, non-abrasive cloth. Avoid using any cleaning solution or glass cleaner!
- Adjust the monitor's brightness, contrast and sharpness controls to enhance readability.
- Avoid displaying fixed patterns on the monitor for long periods of time to avoid image persistence (after image effects).
- Get regular eye checkups.

Ergonomics

To realize the maximum ergonomic benefits, we recommend the following:

- Use the preset Size and Position controls with standard signals.
- Use the preset Color Setting.
- Use non-interlaced signals.
- Do not use primary color blue on a dark background, as it is difficult to see and may produce eye fatigue due to insufficient contrast.
- Suitable for entertainment purposes at controlled luminous environments, to avoid disturbing reflections from the screen.

Cleaning the LCD Panel

- When the liquid crystal panel is dusty, please gently wipe with a soft cloth.
- Please do not rub the LCD panel with hard material.
- Please do not apply pressure to the LCD surface.
- Please do not use OA cleaner as it will cause deterioration or discolor on the LCD surface.

Cleaning the Cabinet

- Unplug the power supply
- Gently wipe the cabinet with a soft cloth
- To clean the cabinet, dampen the cloth with a neutral detergent and water, wipe the cabinet and follow with a dry cloth.

NOTE: DO NOT clean with benzene thinner, alkaline detergent, alcoholic system detergent, glass cleaner, wax, polish cleaner, soap powder, or insecticide. Rubber or vinyl should not be in contact with the cabinet for an extended period of time. These types of fluids and materials can cause the paint to deteriorate, crack or peel.

* The product you purchased may not have this feature.

Contents

Your new MultiSync monitor box* should contain the following:

- LCD monitor
- Power cord*¹
- Video Signal Cable (DisplayPort cable)
- LAN cable
- Setup Manual
- Clamp x 3
- Screw with washer (M4 x 10) x 3
- Screw with washer*² (M3 x 10) x 1 (for Optional Sensor Unit)
- Thumbscrew for optional stand x 2
- Spacer*² x 4
- Pin*² x 4
- CD-ROM



Video Signal Cable
(DisplayPort cable)

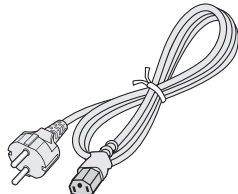

Power Cord*¹



Screw with washer (M4 x 10) x 3
Screw with washer*² (M3 x 10) x 1



Clamp x 3

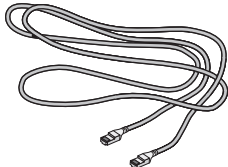

LAN cable



Pin*² x 4

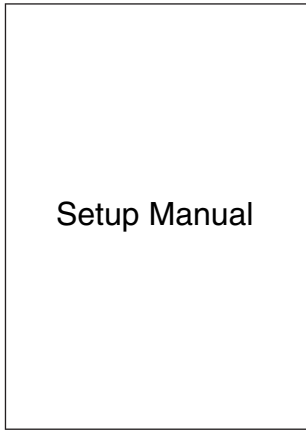

Setup Manual



Thumbscrew for
optional stand x 2



Spacer*² x 4

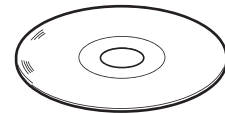

CD-ROM

* Remember to save your original box and packing material to transport or ship the monitor.

*¹ Type and number of power cords included will depend on the where the LCD monitor is to be shipped. When more than one power cord is included, please use a power cord that matches the AC voltage of the power outlet and has been approved by and complies with the safety standard of your particular country.

*² UN551S/UN551VS only.

Options:

- Wall mount
- Tabletop stand
- Remote control kit (remote control and sensor unit)
- Over-frame kit

Installation

This device cannot be used or installed without the Tabletop Stand or other mounting accessory for support. For proper installation it is strongly recommended to use a trained, NEC authorized service person. Failure to follow NEC standard mounting procedures could result in damage to the equipment or injury to the user or installer. Product warranty does not cover damage caused by improper installation. Failure to follow these recommendations could result in voiding the warranty.

For UN551S/UN551VS:

Monitor is protected with a sponge on the side edge of the panel. Please peel it off before using monitor. In order to prevent damage, please do not hit or press strongly the side edges of the panel.

Mounting

DO NOT mount the monitor yourself. Please ask dealer. For proper installation it is strongly recommended to use a trained, qualified technician. Please inspect the location where the unit is to be mounted. Mounting on wall or ceiling is the customer's responsibility. Not all walls or ceilings are capable of supporting the weight of the unit. Product warranty does not cover damage caused by improper installation, remodeling, or natural disasters. Failure to comply with these recommendations could result in voiding the warranty.

DO NOT block ventilated openings with mounting accessories or other accessories.

For NEC Qualified Personnel:

To ensure safe installation, use two or more brackets to mount the unit. Mount the unit to at least two points on the installation location.

Please note the following when mounting on wall or ceiling

- When using mounting accessories other than those that are NEC approved, they must comply with the VESA-compatible (FDMLv1) mounting method.
- NEC recommends mounting interfaces that comply with UL1678 standard in North America.

- NEC strongly recommends using size M6 screws (10-14 mm + thickness of bracket and washer in length). If using screws longer than 10-14 mm, check the depth of the hole. (Recommended Fasten Force: 470 - 635N•cm). Bracket hole should be under ϕ 8.5 mm.

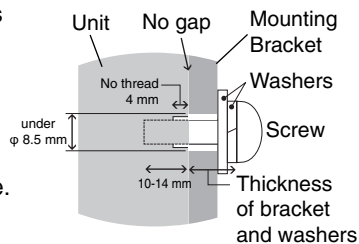

- Prior to mounting, inspect the installation location to insure that it is strong enough to support the weight of the unit so that the unit will be safe from harm.
- Refer to the instructions included with the mounting equipment for detailed information.
- Make sure there is no gap between the monitor and the bracket.
- When used in a video wall configuration for a longer time, slight expansion of the displays may happen due to temperature changes. Due to this it is recommended that over one millimeter gap is kept between adjacent display edges.

For UN551S/UN551VS:

When used in a video wall configuration, you may use attached spacers or pins below position. It is possible to fix each monitor position with pins.

Spacers are useful for keeping gaps. Pins are useful for alignment.

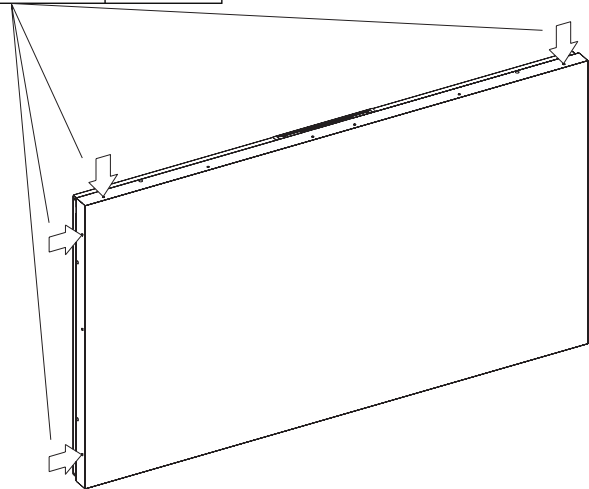
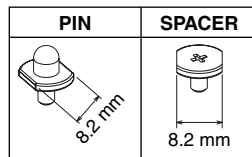

1. Use a wrench for fixing pins and spacers.
2. The tightening torque is 0.63N•m or less.

Pin instruction

You can fix each monitor position with pins. When you use pins, please refer to the instructions below.

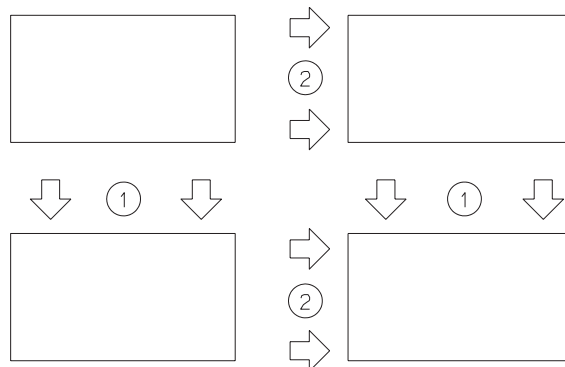

1. Connect all vertical position monitors using pins.
2. Connect each vertical monitor using pins.

Orientation

- When using the display in the portrait position, the monitor should be rotated clockwise so that the left side is moved to the top, right side is moved to the bottom. This will allow for proper ventilation and will extend the lifetime of the monitor. Improper ventilation may shorten the lifetime of the monitor.

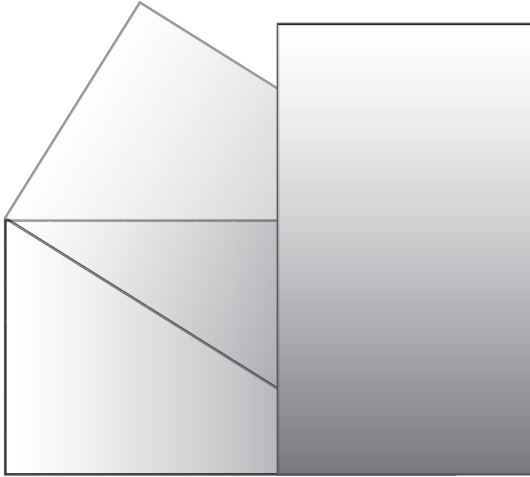

Mounting location

- The ceiling and wall must be strong enough to support the monitor and mounting accessories.
- DO NOT install in locations where a door or gate can hit the unit.
- DO NOT install in areas where the unit will be subjected to strong vibrations and dust.
- DO NOT install near where the main power supply enters the building.
- Do not install in where people can easily grab and hang onto the unit or the mounting apparatus.
- When mounting in a recessed area, as in a wall, leave at least 4 inches (100 mm) of space between the monitor and the wall for proper ventilation.
- Allow adequate ventilation or provide air conditioning around the monitor, so that heat can properly dissipate away from the unit and mounting apparatus.

Mounting on ceiling

- Ensure that the ceiling is sturdy enough to support the weight of the unit and the mounting apparatus over time, against earthquakes, unexpected vibrations, and other external forces.
- Be sure the unit is mounted to a solid structure within the ceiling, such as a support beam. Secure the monitor using bolts, spring lock washers, washer and nut.
- DO NOT mount to areas that have no supporting internal structure. DO NOT use wood screws or anchor screws for mounting. DO NOT mount the unit to trim or to hanging fixtures.

Maintenance

- Periodically check for loose screws, gaps, distortions, or other problems that may occur with the mounting apparatus. If a problem is detected, please refer to qualified personnel for service.
- Regularly check the mounting location for signs of damage or weakness that may occur over time.

Attaching Mounting Accessories

The monitor is designed for use with the VESA mounting system.

1. Attach Mounting Accessories

Be careful to avoid tipping monitor when attaching accessories.

For NEC mounting accessory only*1

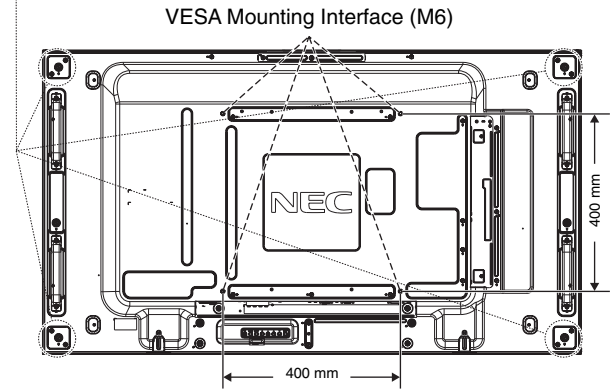

Mounting accessories can be attached with the monitor in the face down position. To avoid damaging the screen face, place the protective sheet on the table underneath the LCD. The protective sheet was wrapped around the LCD in the original packaging. Make sure there is nothing on the table that can damage the monitor.

When using mounting accessories other than NEC compliant and approved, they must comply with the VESA-compatible mounting method.

NOTE: Prior to installation, be sure to place the monitor on a flat area with adequate space.

*1: WM-55UN-L or WM-55UN-P.

2. Using Option Board

- Turn off the main power switch.
- Remove the attached slot cover by unscrewing the installed screws (**Figure 1**).
- Insert option board in to the monitor. Attach the slot cover by using the removed screws.

NOTE: Please contact your supplier for available option boards. Do not apply excessive force to manipulate the optional board before fixing it with screws. Make sure that the board is inserted into the slot in the correct orientation.

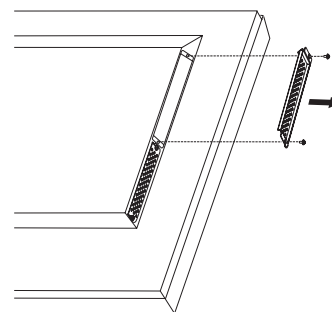

Figure 1

3. Installing and removing optional table top stand

CAUTION: Installing and removing the stand must be done by two or more people.

To install, follow those instructions included with the stand or mounting apparatus. Use only those devices recommended by the manufacturer.

NOTE: Use ONLY thumbscrews which are included in the monitor.

When installing the LCD monitor stand, handle the unit with care to avoid pinching your fingers.

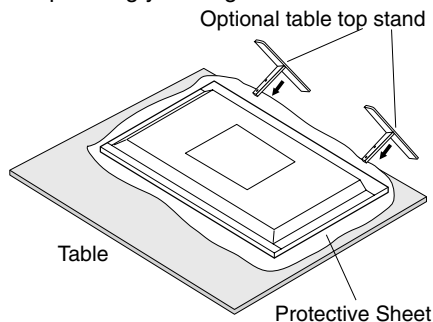

NOTE: Install the stand so the long end of the feet face forward. Use the ST-5220.

4. Ventilation Requirements

When mounting in an enclosed space or recessed area, leave adequate room between the monitor and the enclosure to allow heat to disperse, as shown below.

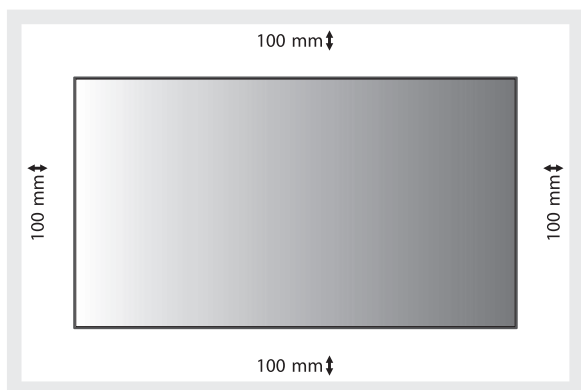

Allow adequate ventilation or provide air conditioning around the monitor, so that heat can properly dissipate away from the unit and mounting apparatus; especially when you use monitors in multiple screen.

5. Prevent Tipping

When using the display with the optional table top stand fasten the LCD to a wall using a cord or chain that can support the weight of the monitor in order to prevent the monitor from falling. Fasten the cord or chain to the monitor using the provided clamps and screws.

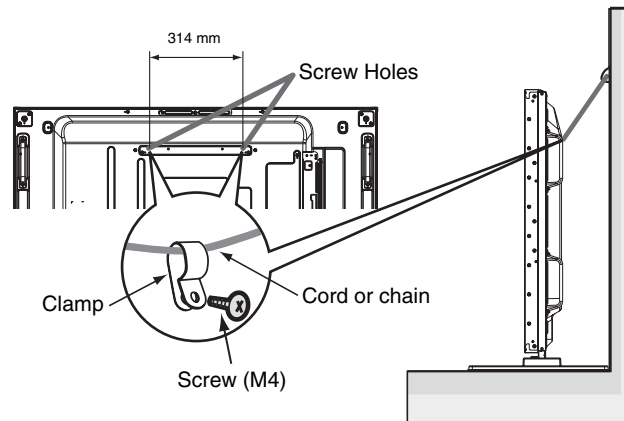

Before attaching the LCD monitor to the wall, make sure that the wall can support the weight of the monitor.

Be sure to remove the cord or chain from the wall before moving the LCD.

Installing Optional Sensor Unit

Fixed by screw: You can secure the sensor unit using the attached screw.

For UN551S/UN551VS, please use the screw attached to the monitor. It isn't possible to use a screw of the Optional Sensor Unit.

For fixing the sensor unit within the bezel, it is recommended using screw holes as below mentioned.

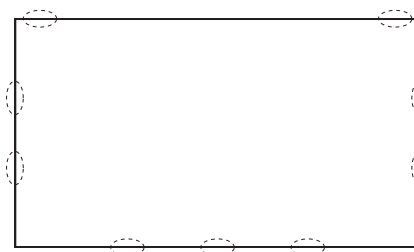

Fixed by double-sided tape: You can set the sensor unit at any side of the monitor.

For setting the sensor unit within the bezel, it is recommended to set the sensor unit in line with the front edge of the bezel.

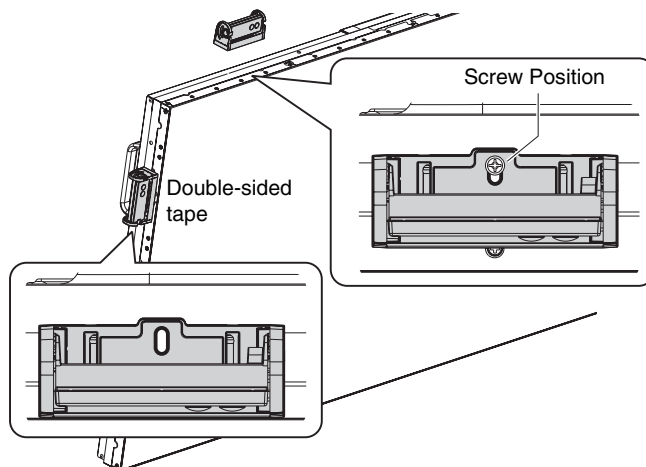

Parts Name and Functions

Control Panel

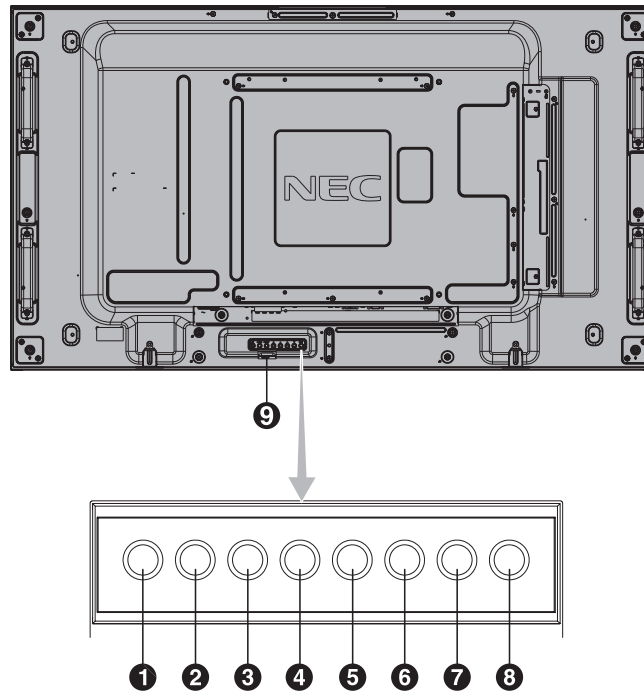

1 POWER button (⏻)

Switches the power on/off. See also page 16.

2 MUTE button (MUTE)

Switches the audio mute ON/OFF.

3 INPUT button (INPUT)

Acts as SET/POINT ZOOM button within OSD menu. (Toggle switches between [DVI], [DPORT], [HDMI], [VGA] or [Y/Pb/Pr], [SCART]*, [VIDEO]*, [S-VIDEO]*, [HDMI2]*, [HDMI3]*, [RGB/HV]* or [Y/Pb/Pr2]*). These are available input only, shown as their factory preset name.

4 PLUS button (+)

Acts as (+) button to increase the adjustment with OSD menu. Increases the audio output level when the OSD menu is turned off.

5 MINUS button (-)

Acts as (-) button to decrease the adjustment with OSD menu. Decreases the audio output level when the OSD menu is turned off.

6 UP button (▲)

Activates the OSD menu when the OSD menu is turned-off. Acts as ▲ button to move the highlighted area up to select adjustment items within OSD menu.

7 DOWN button (▼)

Activates the OSD menu when the OSD menu is turned-off. Acts as ▼ button to move the highlighted area down to select adjustment items within OSD menu.

8 EXIT button (EXIT)

Activates the OSD menu when the OSD menu is turned-off. Acts as EXIT button within the OSD to move to previous menu.

9 Remote control sensor and Power Indicator

Receives the signal from the remote control (when using the wireless remote control). See also page 11.
Glow green when the LCD monitor is in active mode*.
Glow red when the LCD is in POWER OFF mode.
Glow amber when the monitor is in Power Save Mode.
Green and Amber blink alternately while in Power Standby mode with the "SCHEDULE SETTINGS" function enabled.
When a component failure is detected within the monitor, the indicator will blink red.

* If "OFF" is selected in "POWER INDICATOR" (see page 26), LED will not light when the LCD monitor is in active mode.

Control Key Lock Mode

This control completely locks out access to all Control Key functions. To activate the control key lock function, press both ▼ and ▲ and hold down simultaneously for more than 3 seconds. To resume user mode, press both ▼ and ▲ and hold simultaneously for more than 3 seconds.

*: This function depends on which option board you use.

Terminal Panel

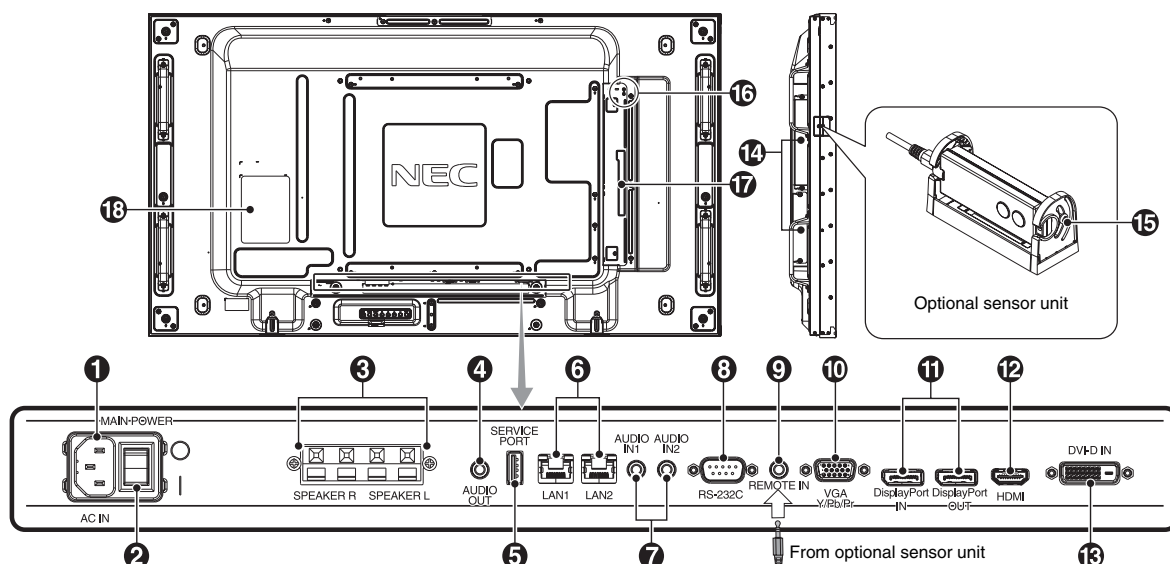

1 AC IN connector

Connects with the supplied power cord.

2 Main Power Switch

On/Off switch to turn main power ON/OFF.

3 EXTERNAL SPEAKER TERMINAL

To output the audio signal from AUDIO 1, DPORT and HDMI.
Red terminal is plus (+).
Black terminal is minus (-).

NOTE: This speaker terminal is for 15 W + 15 W (8 ohm) speaker.

4 AUDIO OUT

To output the audio signal from the AUDIO IN 1, 2, DPORT and HDMI to an external device (stereo receiver, amplifier, etc.).

* This connector does not support Headphone terminal.

5 Service port

This USB slot is for future software upgrades.

6 LAN port (RJ-45)

LAN connection. See page 33 and 36.

NOTE: Please give priority for use to LAN1.

7 AUDIO IN 1, 2

To input audio signal from external equipment such as a computer or DVD player.

8 RS-232C (D-Sub 9 pin)

Connect RS-232C input from external equipment such as a computer in order to control RS-232C functions.

9 REMOTE IN

Use the optional sensor unit by connecting it to your monitor.

NOTE: Do not use this connector unless specified.

10 VGA IN (mini D-Sub 15 pin)

To input analog RGB signals from a personal computer or from other RGB equipment. This input can be used with an RGB or COMPONENT source. Please select signal type in TERMINAL SETTING. See page 28.

NOTE: When you use this connector for COMPONENT, please use a suitable signal cable. If you have any questions, please ask your dealer.

11 DisplayPort connectors

IN connector: To input DisplayPort signals.

OUT connector: To output signal which is displayed.

See page 26 VIDEO OUT SETTING.
To output signal which is displayed as a main picture when selected PIP mode. See page 11.

12 HDMI IN

To input digital HDMI signals.

13 DVI IN (DVI-D)

To input digital RGB signals from a computer or HDTV device having a digital RGB output.

* This connector does not support analog input.

14 Option board slot

Slot 2 and slot 3 type accessories are available.

Please contact your supplier for detailed information.

NOTE: Please contact your supplier for available option board.

15 Optional sensor unit (remote control, room light sensing sensor and human sensor)

Receives the signal from the Remote control.

Detects the level of ambient light, allowing the monitor to make automatic adjustments to the backlight setting, resulting in a more comfortable viewing experience. Do not cover this sensor.

Detects human presence in front of the monitor.

16 Kensington Lock

For security and theft prevention.

17 Intelligent wireless data sensor

Sensor for wireless communication of the monitor information and settings.

18 Rating Label

Wireless Remote Control (Optional)

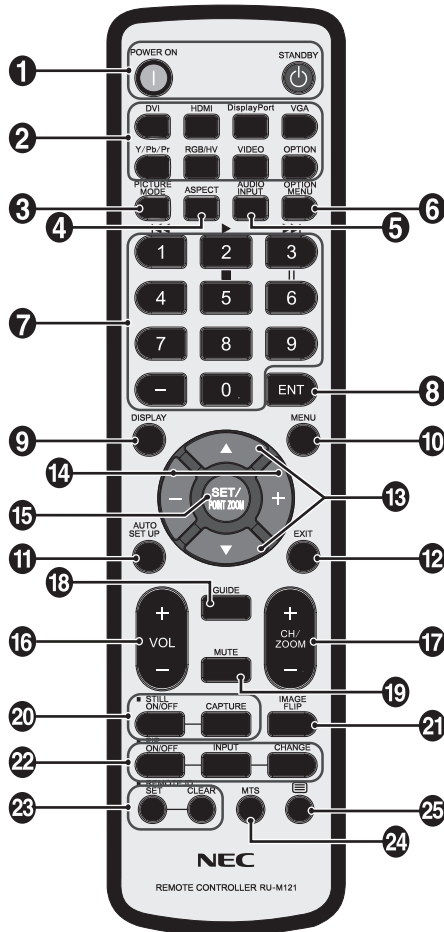

1 POWER button

Switches the power on/standby.

2 INPUT button

Selects input signal.

DVI: DVI
HDMI: HDMI, HDMI2*2, HDMI3*2
DisplayPort: DPORT
VGA: VGA
Y/Pb/Pr: Y/Pb/Pr, SCART*2, Y/Pb/Pr2*2
RGB/HV*2: RGB/HV
VIDEO*2: VIDEO, S-VIDEO
OPTION: Depends on your connection

3 PICTURE MODE button

Selects picture mode, [HIGHBRIGHT], [STANDARD], [sRGB], [CINEMA], [CUSTOM1], [CUSTOM2]. See page 18.

HIGHBRIGHT: for moving images such as DVD.
STANDARD: for images.
sRGB: for text based images.
CINEMA: for movies.
CUSTOM1 and CUSTOM2: activate auto dimming function. See page 30.

4 ASPECT button

Selects picture aspect, [FULL], [WIDE], [DYNAMIC], [1:1], [ZOOM] and [NORMAL]. See page 17.

5 AUDIO INPUT button

Selects audio input source [IN1], [IN2], [IN3]*2, [OPTION]*2, [HDMI], [DPORT], [HDMI2]*2, [HDMI3]*2.

6 OPTION MENU button*1

7 KEYPAD

Press buttons to set and change passwords, change channel and set REMOTE ID.

8 ENT button*1

9 DISPLAY button

Turns on/off the information OSD. See page 18.

10 MENU button

Turns on/off the menu mode.

11 AUTO SET UP button

Enters auto setup menu. See page 20.

12 EXIT button

Returns to previous menu within OSD menu.

13 UP/DOWN button (▲/▼)

Acts as ▲ ▼ button to move the highlighted area up or down to select adjustment items within OSD menu. Small screen which adjusted "PIP" mode moves up or down.

14 MINUS/PLUS (-/+) button

Increases or decreases the adjustment level within OSD menu settings. Small screen which adjusted "PIP" mode moves left or right and increases or decreases the size.

15 SET/POINT ZOOM button

Makes selection. Activates POINT ZOOM function when OSD menu is not shown.

16 VOLUME UP/DOWN button (VOL +/-)

Increases or decreases audio output level.

17 CH/ZOOM UP/DOWN button (CH/ZOOM +/-)*1

Increases or decreases POINT ZOOM level.

18 GUIDE button*1

19 MUTE button

Turns on/off mute function.

20 STILL button

ON/OFF button: Activates/deactivates still picture mode.

STILL CAPTURE button: Captures still picture.

NOTE: This function is released when activating IMAGE FLIP.

21 IMAGE FLIP button

Toggle switches between H FLIP, V FLIP, 180° ROTATE and NONE. See page 21.

22 PIP (Picture In Picture) button

ON/OFF button: Toggle switches between PIP, POP, PICTURE BY PICTURE-ASPECT and PICTURE BY PICTURE-FULL. See page 22.

INPUT button: Selects the “picture in picture” input signal.

CHANGE button: Replaces to the main picture and sub picture.

NOTE: Enable to change the sub picture size by pressing SET/POINT ZOOM button during PIP mode.

For detail information, see “PIP (Picture in Picture) matrix” in page 53.

23 REMOTE ID button

Activates REMOTE ID function.

24 MTS button*1

25 button*1

Activates closed captioning.

NOTE: VIDEO*2, S-VIDEO*2 inputs only.

*1: This button's action depends on which option board you use. Refer to the option board's manual for further information.

*2: This function depends on which option board you use.

Operating Range for the Optional Remote Control

Point the top of the remote control toward the optional sensor unit's remote control sensor in the remote control kit during button operation.

Use the remote control within a distance of about 7 m (23 ft.) from remote control sensor or at a horizontal and vertical angle of within 30° within a distance of about 3.5 m (10 ft.).

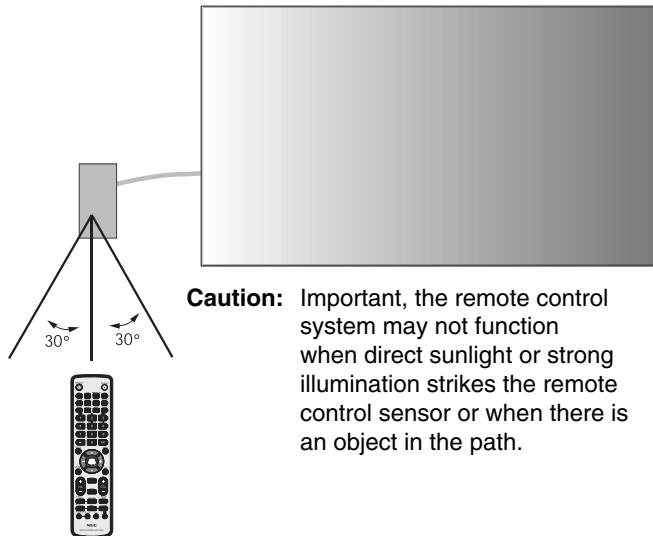

Handling the remote control

- Do not subject to strong shock.
- Do not allow water or other liquid to splash the remote control. If the remote control gets wet, wipe it dry immediately.
- Avoid exposure to heat and steam.
- Other than to install the batteries, do not open the remote control.

Setup

1. Determine the installation location

CAUTION: Installing your LCD monitor must be done by a qualified technician. Contact your dealer for more information.

CAUTION: MOVING OR INSTALLING THE LCD MONITOR MUST BE DONE BY TWO OR MORE PEOPLE. Failure to follow this caution may result in injury if the LCD monitor falls.

CAUTION: Do not mount or operate the monitor upside down, face up or face down.

CAUTION: This LCD has a temperature sensor and cooling fan, including a fan for the option board.

If the LCD becomes too hot, the cooling fan will turn on automatically.

The option board's fan is active although the temperature is lower than normal operating temperature for cooling the option board. If the LCD becomes overheated while the cooling fan is running, a "Caution" warning will appear. If the "Caution" warning appears, discontinue use and allow the unit to cool. Using the cooling fan will reduce the likelihood of early circuit failure and may help reduce image degradation and "Image Persistence".

If the LCD is used in an enclosed area or if the LCD panel is covered with a protective screen, please check the inside temperature of the monitor by using the "HEAT STATUS" control in the OSD (see page 26). If the temperature is higher than the normal operating temperature, please turn the cooling fan to ON within the FAN CONTROL menu within the OSD (see page 26).

IMPORTANT: Lay the protective sheet, which was wrapped around the LCD monitor when it was packaged, beneath the LCD monitor so as not to scratch the panel.

2. Install the remote control (Optional) batteries

The remote control is powered by two 1.5V AAA batteries. To install or replace batteries:

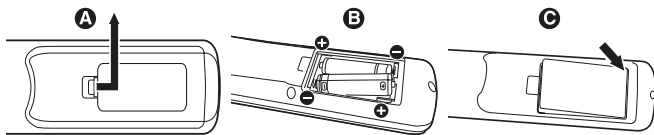

- Press and slide to open the cover.
- Align the batteries according to the (+) and (-) indications inside the case.
- Replace the cover.

CAUTION: Incorrect usage of batteries can result in leaks or bursting.

NEC recommends the following battery use:

- Place "AAA" size batteries matching the (+) and (-) signs on each battery to the (+) and (-) signs of the battery compartment.
- Do not mix battery brands.
- Do not combine new and old batteries. This can shorten battery life or cause liquid leakage of batteries.
- Remove dead batteries immediately to prevent battery acid from leaking into the battery compartment.
- Do not touch exposed battery acid, it may injure skin.

NOTE: If you do not intend to use the Remote Control for a long period of time, remove the batteries.

3. Connect external equipment (See pages 14 and 15)

- To protect the external equipment; turn off the main power before making connections.
- Refer to your equipment user manual for further information.

NOTE: Do not connect/disconnect cables when turning on the monitor or other external equipment as this may result in a loss of the monitor image.

4. Connect the supplied power cord

- The equipment should be installed close to an easily accessible power outlet.
- Please fasten power cord to the LCD monitor by attaching the screw and clamp.
- Fully insert the prongs into the power outlet socket. A loose connection may cause image degradation.

NOTE: Please refer to the "Safety Precautions and Maintenance" section of this manual for proper selection of AC power cord.

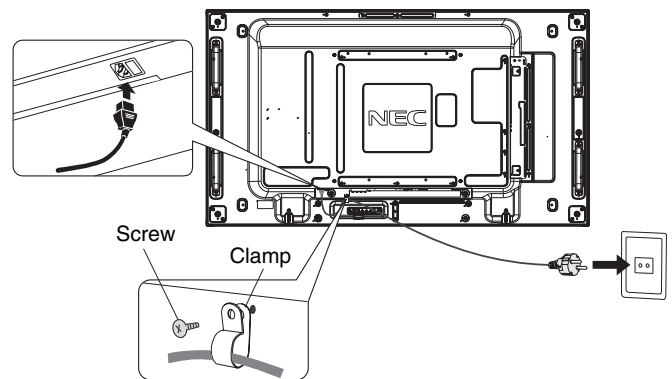

5. Switch on the power of all the attached external equipment

When connected with a computer, switch on the power of the computer first.

6. Operate the attached external equipment

Display the signal from the desired input source.

7. Adjust the sound

Make volume adjustments when required.

8. Adjust the screen (See pages 20 and 21)

Make adjustments of the screen display position when necessary.

9. Adjust the image (See page 20)

Make adjustments such as backlight or contrast when required.

10. Recommended Adjustments

To reduce the risk of the "Image Persistence", please adjust the following items based on the application being used: "SCREEN SAVER", "SIDE BORDER COLOR" (See page 26) "DATE & TIME", "SCHEDULE SETTINGS" (See page 22). It is recommended that the "FAN CONTROL" setting (See page 26) be turned to ON also.

Connections

NOTE: Do not connect/disconnect cables when turning on the monitor or other external equipment as this may result in a loss of the monitor image.

NOTE: Use an audio cable without a built-in resistor. Using an audio cable with a built-in resistor turns down the sound.

Before making connections:

- * First turn off the power of all the attached equipment and make connections.
- * Refer to the user manual included with each separate piece of equipment.

Wiring Diagram

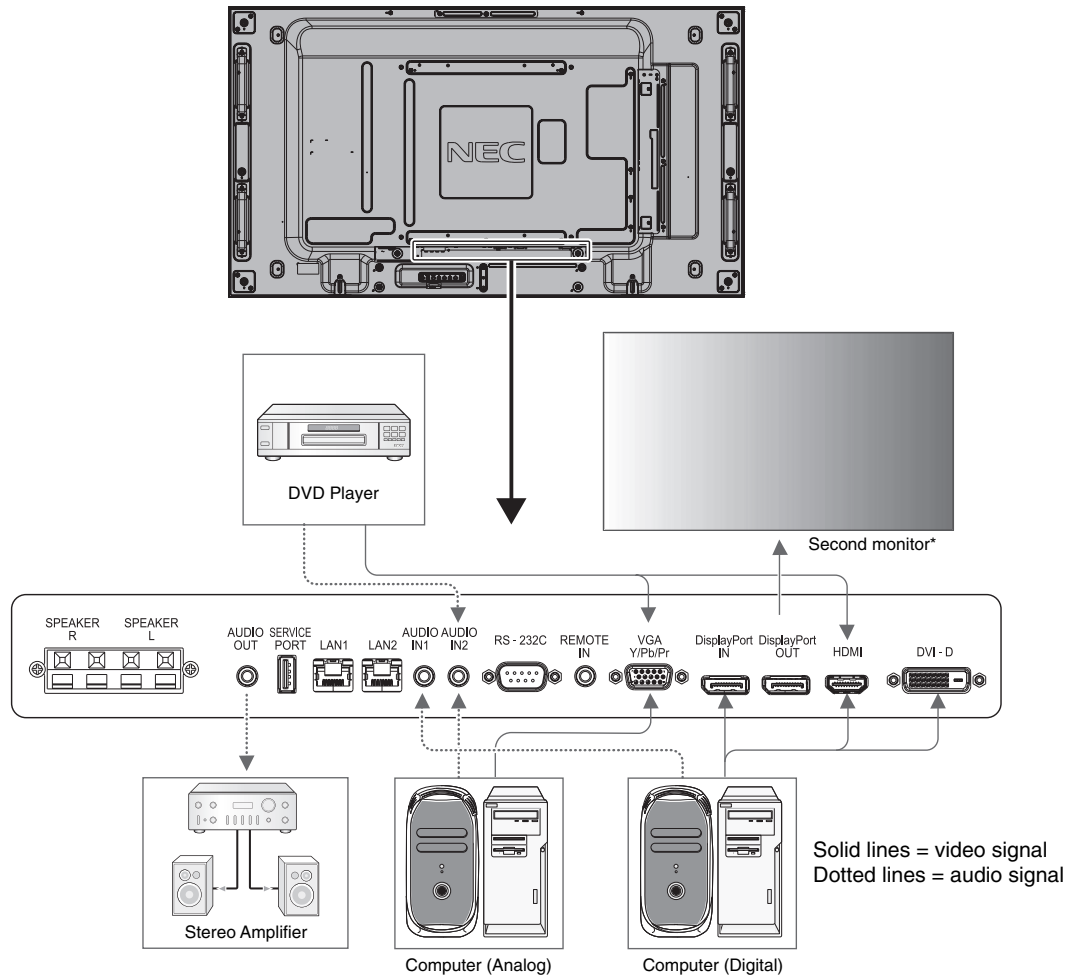

*: Multiple monitors that are daisy-chained have a limit to the connectable monitors.

Connected equipment	Connecting terminal	Setting in terminal mode	Input signal name	Connecting audio terminal	Input button in remote control
AV	DisplayPort	RAW/EXPAND*1	DP	DPORT	DisplayPort
	DVI (DVI-D)	DVI-HD	DVI	AUDIO IN1/IN2	DVI
	HDMI	RAW/EXPAND*1	HDMI	HDMI	HDMI
	VGA (D-Sub)	D-SUB MODE RGB	VGA	AUDIO IN1/IN2	RGB/HV
	VGA (D-Sub)	D-SUB MODE COMPONENT	COMPONENT	AUDIO IN1/IN2	Y/Pb/Pr
	Option	RAW/EXPAND*1	OPTION	OPTION	OPTION
PC	DisplayPort	RAW/EXPAND*1	DP	DPORT	DisplayPort
	DVI (DVI-D)	DVI-PC	DVI	AUDIO IN1/IN2	DVI
	HDMI	RAW/EXPAND*1	HDMI	HDMI	HDMI
	VGA (D-Sub)	-	VGA	AUDIO IN1/IN2	RGB/HV
	Option	RAW/EXPAND*1	OPTION	OPTION	OPTION

*1: depend on signal type.

Connecting a Personal Computer

Connecting your computer to your LCD monitor will enable you to display your computer's screen image.

Some display cards may not display an image correctly.

Your LCD monitor displays proper image by adjusting the factory preset timing signal automatically.

<Typical factory preset signal timing>

Resolution	Scanning frequency		Remarks
	Horizontal	Vertical	
640 x 480	31.5 kHz	60 Hz	
800 x 600	37.9 kHz	60 Hz	
1024 x 768	48.4 kHz	60 Hz	
1280 x 768	48 kHz	60 Hz	
1360 x 768	48 kHz	60 Hz	
1280 x 1024	64 kHz	60 Hz	
1600 x 1200	75 kHz	60 Hz	Compressed image
1920 x 1080	67.5 kHz	60 Hz	Recommended resolution

- If you use with a Macintosh device, set "Mirroring" to Off on your PowerBook.
Refer to your Macintosh's owner's manual for more information about your computer's video output requirements and any special identification or configuration your monitor's image and monitor may require.
- Input TMDS signals conforming to DVI standards.
- To maintain display quality, use a cable that conforms to DVI standards.

Connecting a DVD Player or Computer with HDMI out

- Please use an HDMI cable with HDMI logo.
- It may take a moment for the signal to appear.
- Some display cards or drivers may not display an image correctly.
- When you use a computer with HDMI out, please set OVER SCAN to "OFF" (see page 29).

Connecting a Computer with DisplayPort

- Please use DisplayPort cable with DisplayPort compliance logo.
- It may take a moment for the signal to appear.
- Please note that when connecting a DisplayPort cable to a component with a signal conversion adapter, an image may not appear.
- Select DisplayPort cables feature a locking function. When removing this cable, hold down the top button to release the lock.

Basic Operation

Power ON and OFF Modes

The LCD monitor power indicator will turn green while powered on and will turn red or amber while powered off.

NOTE: The Main Power Switch must be in the ON position in order to power up the monitor using the remote control or the Power Button.

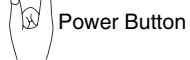
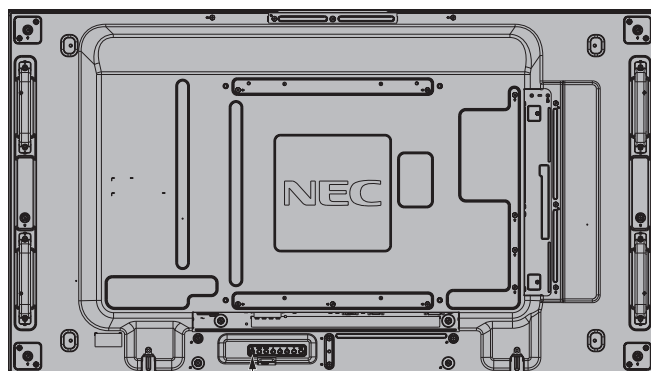
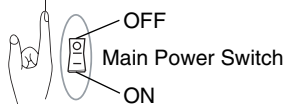
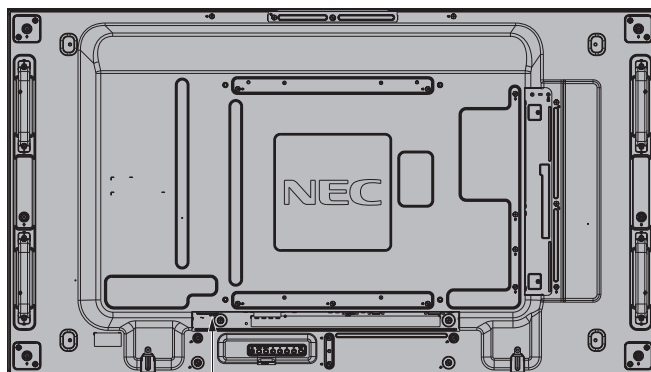

Using the optional remote control

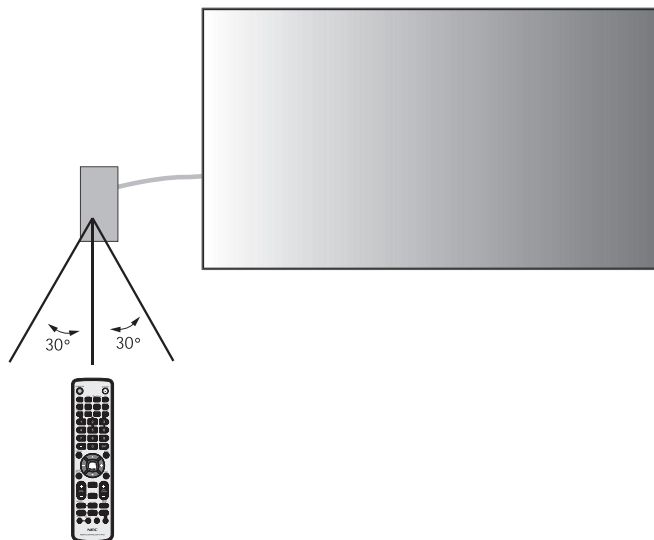

Power Indicator

Mode	Status Indicator Light
Power ON	Green*1
Power OFF and Power Save "AUTO STANDBY" Power consumption under 0.5 W*2	Red
Power Save "AUTO POWER SAVE" Power consumption under 2.5 W	Amber
Power Standby when "SCHEDULE SETTINGS" enabled	Green and Amber blink alternately
Diagnosis (Detecting failure)	Red Blinking (See Troubleshooting page 48)

*1 If "OFF" is selected in POWER INDICATOR (page 26), the LED will not light when the LCD monitor is in active mode.
*2 Without any option, with factory settings.

Initial settings

Setting LAN POWER (see page 27) and POWER SAVE (see page 26) windows appear the first time the power is on. These settings are only necessary upon initial setup. However, this message window appears when the power is on after FACTORY RESET is done.

Using Power Management

The LCD monitor follows the VESA approved DPM Display Power Management function. The power management function is an energy saving function that automatically reduces the power consumption of the display when the keyboard or the mouse has not been used for a fixed period. The power management feature on your new display has been set to the "AUTO STANDBY" mode. This allows your display to enter a Power Saving Mode when no signal is applied. This could potentially increase the life and decrease the power consumption of the display.

NOTE: Depending on the computer and display card used, this function may not operate.

NOTE: The monitor automatically goes into OFF at the preset time period after signal is lost.

Selecting a video source*4

To view a video source:

Use the input button to set [VIDEO], [S-VIDEO].

Use the COLOR SYSTEM menu to set [AUTO], [NTSC], [PAL], [SECAM], [PAL60], [4.43NTSC], according to your video format.

Picture Aspect

DVI, VGA, RGV/HV*4, DPORT
FULL → 1:1 → ZOOM → NORMAL

HDMI, Y/Pb/Pr, SCART*4, VIDEO*4, S-VIDEO*4, HDMI2*4, HDMI3*4, Y/Pb/Pr2*4

FULL → WIDE → DYNAMIC → 1:1 → ZOOM → NORMAL

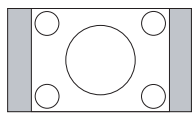
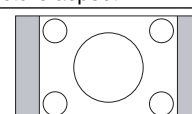
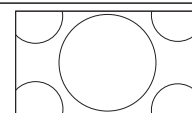
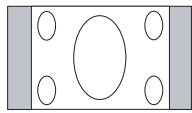
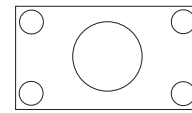
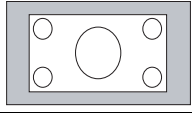
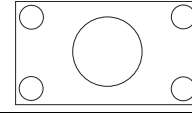
Aspect ratio of image	Unchanged view*3	Recommended selection for picture aspect*3
4:3		NORMAL 
		DYNAMIC 
Squeeze		FULL 
Letterbox		WIDE 

*3 Grey areas indicate unused portions of the screen.

NORMAL: Displays the aspect ratio the same as it is sent from the source.

FULL: Fills entire screen.

WIDE: Expands a 16:9 letter box signal to fill entire screen.

DYNAMIC: Expands a 4:3 pictures to fill the entire screen with non-linearity. Some of the outside image area will be cut off due to expansion.

1:1: Displays the image in a 1 by 1 pixel format.

ZOOM

The image can be expanded beyond the active display area. The image which is outside of active display area is not shown.

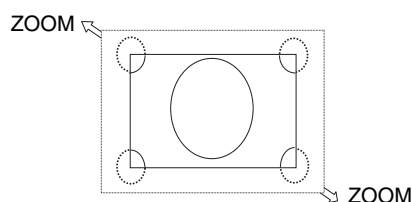

*4: This function depends on which option board you use.

Information OSD

The Information OSD provides information such as: Input Source, Picture Size, etc.
Press the DISPLAY button on the remote to bring up the Information OSD.

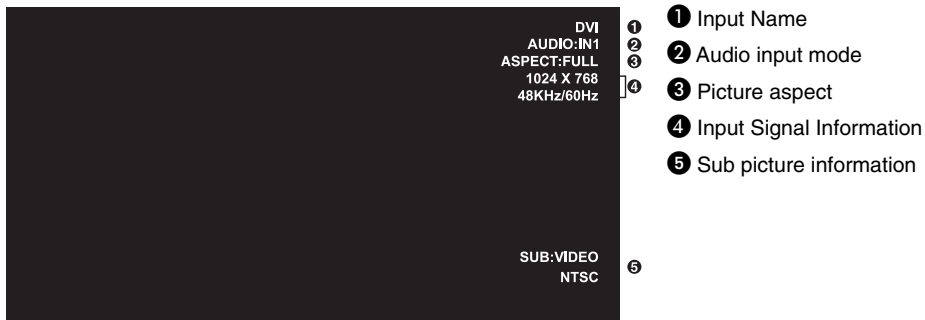

Picture Mode

DVI, VGA, RGB/HV*, DPORT

STANDARD → sRGB → CUSTOM1 → CUSTOM2 → HIGHBRIGHT



HDMI, Y/Pb/Pr, SCART*, VIDEO*, S-VIDEO*, HDMI2*, HDMI3*, Y/Pb/Pr2*

STANDARD → CINEMA → CUSTOM1 → CUSTOM2 → HIGHBRIGHT



*: This function depends on which option board you use.

OSD (On-Screen-Display) Controls



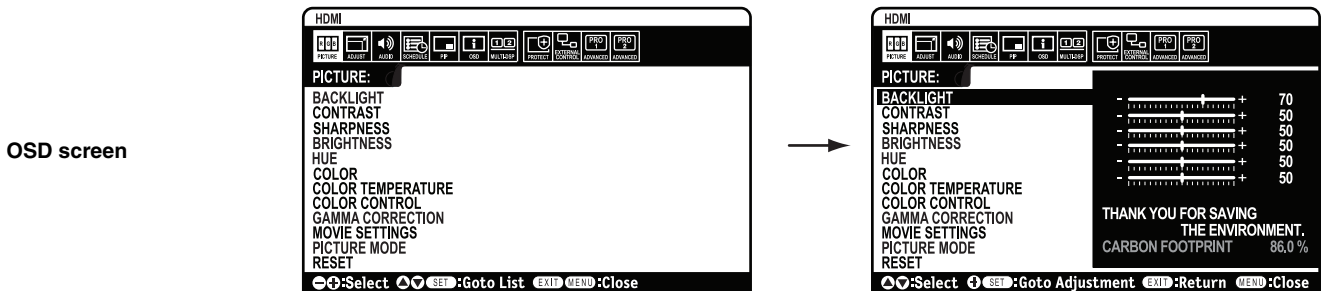
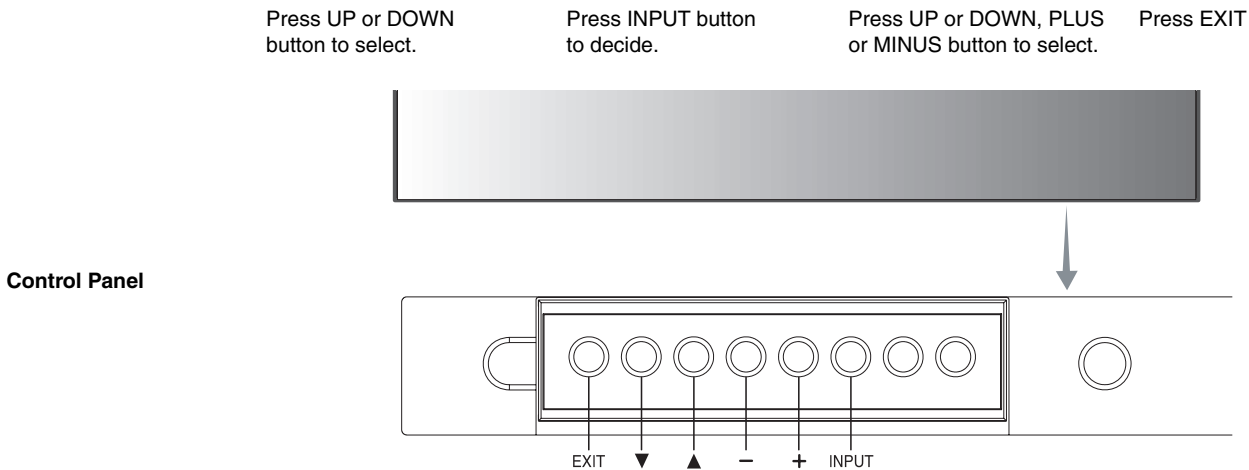
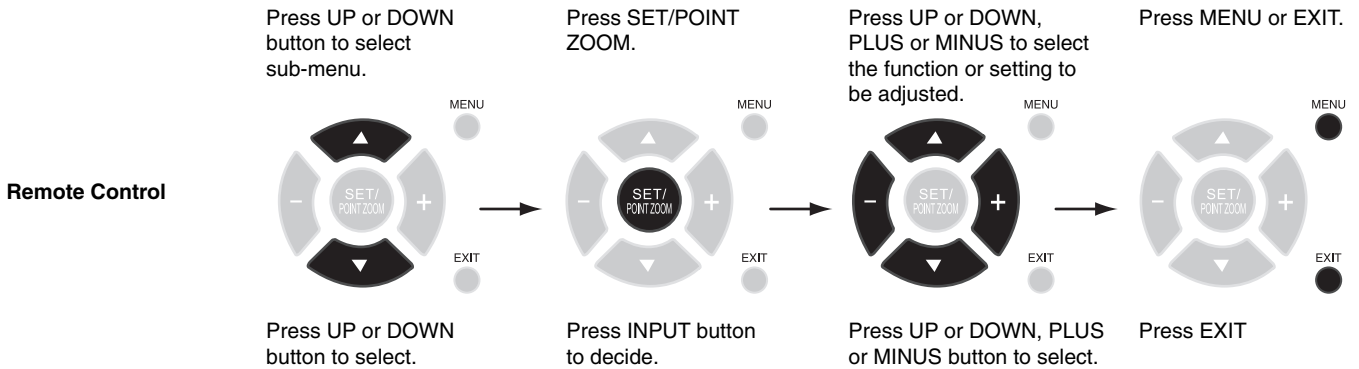
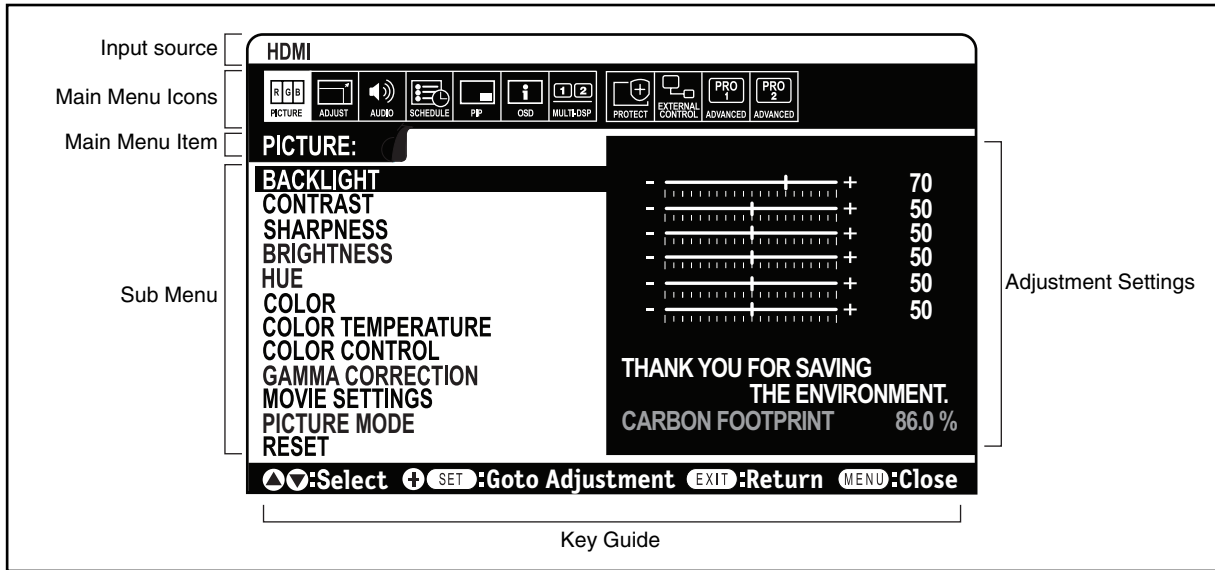

NOTE: Some functions may not be available depending on the model or optional equipment.



Setting		Default
PICTURE		
BACKLIGHT	Adjusts the overall image and background brightness. Press + or - to adjust. NOTE: When MODE1 or MODE2 is selected in ROOM LIGHT SENSING, this function cannot be changed.	Depends on destination
CONTRAST	Adjusts the image brightness in relationship to the input signal. Press + or - to adjust. NOTE: When sRGB is selected in picture mode, this function cannot be changed.	50
SHARPNESS	Adjusts the crispness of the image. Press + or - to adjust.	50*2
BRIGHTNESS	Adjusts the image brightness in relationship to the background. Press + or - to adjust. NOTE: When sRGB is selected in picture mode, this function cannot be changed.	50
HUE	Adjusts the hue of the screen. Press + or - to adjust. NOTE: When sRGB is selected in picture mode, this function cannot be changed.	50
COLOR	Adjusts the color depth of the screen. Press + or - to adjust. NOTE: When sRGB is selected in picture mode, this function cannot be changed.	50*2
COLOR TEMPERATURE	Adjusts the color temperature of the entire screen. A low color temperature will make the screen reddish. A high color temperature will make the screen bluish. If TEMPERATURE needs further adjustment, the individual R/G/B/ levels of the white point can be adjusted. To adjust the R/G/B levels, CUSTOM must be showing as the COLOR TEMP selection. NOTE: When sRGB is selected in picture mode, predefined 6500k is set so it cannot be changed. When PROGRAMMABLE1, PROGRAMMABLE2 or PROGRAMMABLE3 is selected in GAMMA CORRECTION, this function cannot be changed.	10000K
COLOR CONTROL	Adjusts the hue of the Red, Yellow, Green, Cyan, Blue and Magenta. NOTE: When sRGB is selected in picture mode, this function cannot be changed. When INPUT2 of SUPER is selected in INPUT CHANGE and displayed, this function cannot be changed.	0
GAMMA CORRECTION	Select a display gamma for best picture quality. NOTE: When sRGB is selected in picture mode, this function cannot be changed.	PROGRAMMABLE1 (except sRGB setting)
NATIVE	Gamma correction is handled by the LCD panel.	
2.2	Typical display gamma for use with a computer.	
2.4	Good for video (DVD, etc.)	
S GAMMA	Special gamma for certain types of movies. Raises the dark parts and lowers the light parts of the image (S-Curve).	
DICOM SIM.	DICOM GSDF curve simulated for LCD type.	
PROGRAMMABLE1, 2, 3	A programmable gamma curve can be loaded using NEC optional software.	
MOVIE SETTINGS	NOTE: When INPUT2 of SUPER is selected in INPUT CHANGE and displayed, this function cannot be changed.	
NOISE REDUCTION*1 <small>SCART, VIDEO, S-VIDEO inputs only</small>	Adjusts the amount of noise reduction. Press + or - to adjust.	0*2
TELECINE <small>HDMI, Y/Pb/Pr, SCART*, VIDEO*, S-VIDEO*, HDMI2*, HDMI3*, Y/Pb/Pr2* inputs only</small>	Automatically senses the sources frame rate for optimal picture quality.	AUTO*2
ADAPTIVE CONTRAST <small>HDMI, Y/Pb/Pr, SCART*, VIDEO*, S-VIDEO*, HDMI2*, HDMI3*, Y/Pb/Pr2* inputs only</small>	Sets the level of adjustment for dynamic contrast.	OFF
PICTURE MODE	Selects picture mode, [HIGHBRIGHT], [STANDARD], [sRGB], [CINEMA], [CUSTOM1] or [CUSTOM2]. See page 18.	Depends on destination
RESET	Resets the following settings within the PICTURE menu back to factory setting: BACKLIGHT, CONTRAST, SHARPNESS, BRIGHTNESS, HUE, COLOR, COLOR TEMPERATURE, COLOR CONTROL, GAMMA CORRECTION, MOVIE SETTINGS.	-
ADJUST		
AUTO SETUP <small>VGA, RGB/HV* inputs only</small>	Automatically adjusts Screen Size, H position, V position, Clock, Phase and White Level.	-
AUTO ADJUST <small>VGA, RGB/HV* inputs only</small>	H Position, V Position and Phase are adjusted automatically when new timing is detected.	OFF
H POSITION <small>All inputs except DVI, HDMI, DPORT</small>	Controls the horizontal position of the image within the Display area of the LCD. Press + to move right. Press - to move left.	-
V POSITION <small>All inputs except DVI, HDMI, DPORT</small>	Controls the vertical position of the image within the Display area of the LCD. Press + to move up. Press - to move down.	-
CLOCK <small>VGA, RGB/HV* inputs only</small>	Press + to expand the width of the image on the right of the screen. Press - to narrow the width of the image on the left.	-

*1: This function depends on which option board you use.

*2: Depends on signal input.

PHASE VGA, RGB/HV*1, Y/Pb/Pr, SCART*1, Y/Pb/Pz*1 inputs only	Adjusts the visual "noise" on the image.	-
H RESOLUTION VGA, RGB/HV*1 inputs only	Adjusts the horizontal size of the image.	-
V RESOLUTION VGA, RGB/HV*1 inputs only	Adjusts the vertical size of the image.	-
INPUT RESOLUTION VGA, RGB/HV*1 inputs only	If there is a problem with signal detection, this function forces the monitor to display the signal at the desired resolution. After selection, execute "AUTO SETUP" if required. If no problem is detected, the only available option will be "AUTO".	AUTO
ASPECT	Select the aspect ratio of the screen image. NOTE: When the ASPECT is DYNAMIC, WIDE or ZOOM, the image will be changed FULL image before IMAGE FLIP, then start to IMAGE FLIP. When the ASPECT is DYNAMIC or ZOOM, the image will be changed FULL image before TILE MATRIX, then start to TILE MATRIX. After TILE MATRIX, the ASPECT will be returned previous ASPECT or set ASPECT during TILE MATRIX. When the ASPECT is DYNAMIC or ZOOM, the image will be changed FULL image before POINT ZOOM, then start to POINT ZOOM. After POINT ZOOM, the ASPECT will be returned previous ASPECT. When the ASPECT is changed during POINT ZOOM, DYNAMIC and ZOOM will be FULL image.	FULL
NORMAL	Displays the aspect ratio the same as it is sent from the source.	-
FULL	Fills entire screen.	-
WIDE	Expands a 16:9 letter box signal to fill entire screen.	-
DYNAMIC	Expands a 4:3 pictures to fill the entire screen with non-linearity. Some of the outside image area will be cut off due to expansion. TILE MATRIX becomes invalid.	-
1:1	Display the image in a 1 by 1 pixel format. (If the input resolution is higher than a 1920 x 1080 resolution, the image will be scaled down to fit the screen). TILE MATRIX becomes invalid.	-
ZOOM	The image can be expanded/reduced. NOTE: The expanded image which is outside of active display area is not shown. The reduced image may have some image degradation.	-
ZOOM	Maintains the aspect ratio while zooming.	-
HZOOM	Amount of horizontal zoom.	-
VZOOM	Amount of vertical zoom.	-
H POS	Horizontal position. NOTE: The image does not change upon a reduced image setting.	-
V POS	Vertical position. NOTE: The image does not change upon a reduced image setting.	-
IMAGE FLIP	NOTE: OVER SCAN is disabled when IMAGE FLIP is selected. When the ASPECT is DYNAMIC, WIDE or ZOOM, the image will be changed FULL image before IMAGE FLIP, then start to IMAGE FLIP. When selecting IMAGE FLIP except for NONE, following functions are released: PIP MODE, TILE MATRIX, SUPER in INPUT CHANGE, STILL, POINT ZOOM.	-
IMAGE FLIP	Display the inverse image right-left, up-down or rotation. Press + or - to select.	NONE
NONE	Normal mode. 	-
H FLIP	The image inverts right-left. 	-
V FLIP	The image inverts up-down. 	-
180° ROTATE	The image rotates 180 degrees. 	-
OSD FLIP	Determines the OSD display direction. If "ON" is selected, OSD will invert depending on the image.	OFF
RESET	Resets "ADJUST" settings back to factory settings.	-
AUDIO		
VOLUME	Increases or decreases output volume level.	40
BALANCE	Select "STEREO" or "MONO" of audio output. If you select "STEREO", adjust the balance of L/R volume. Press + button to move the stereo sound image to right. Press - button to move the stereo sound image to left.	CENTER, STEREO
TREBLE	To accentuate or reduce the high frequency sound. Press + button to increase TREBLE sound. Press - button to decrease TREBLE sound.	0

*1: This function depends on which option board you use.

BASS	To accentuate or reduce the low frequency sound. Press + button to increase BASS sound. Press - button to decrease BASS sound.	0
SURROUND	Artificial surround sound. NOTE: Audio out is disabled when this function is set to ON.	OFF
PIP AUDIO	Selects source of PIP audio.	MAIN AUDIO
LINE OUT	Selecting "VARIABLE" enables control of the line out level with the VOLUME button. NOTE: Audio out is disabled when this function is set to ON.	FIXED
AUDIO INPUT	Selects audio input source [IN1], [IN2], [IN3]*1, [OPTION]*1, [HDMI], [DPORT], [HDMI2]*1, [HDMI3]*1.	Depends on signal input
AUDIO DELAY	Enables to set the delay time to output the audio. DELAY TIME can be set between 0 and 100 milliseconds. "ON" activates this function.	ON, 37 MSEC.
RESET	Resets "AUDIO" options back to factory settings except VOLUME.	-
SCHEDULE		
OFF TIMER	Sets the monitor to power off after a length of time. A time between 1 to 24 hours is available.	OFF
SCHEDULE SETTINGS	Creates a working schedule for the monitor to use. NOTE: If your schedule is across date, please set ON time and OFF time individually at Settings.	-
SCHEDULE LIST	List of schedules.	-
DATE & TIME	Sets the date, time, and daylight saving region. Date & time must be set in order for the "SCHEDULE" function to operate. See page 31.	
YEAR	Configures the year for the real-time clock.	-
MONTH	Configures the month for the real-time clock.	-
DAY	Configures the day for the real-time clock.	-
TIME	Configures the time for the real-time clock.	-
DAYLIGHT SAVING	Configures daylight savings on or off.	OFF
RESET	Resets the following settings within the SCHEDULE menu back to factory setting: OFF TIMER, SCHEDULE SETTINGS.	-
PIP		
KEEP PIP MODE	Allows the monitor to remain in "PIP" and "TEXT TICKER" mode after powering off. When Power is returned, PIP and TEXT TICKER appear without having to enter the OSD.	OFF
PIP MODE	Selects Picture-in-Picture mode. NOTE: This function is released when selecting IMAGE FLIP except for NONE.	OFF
OFF	Normal mode.	
PIP	Picture in Picture mode.	
POP	Picture out Picture mode.	
PICTURE BY PICTURE-ASPECT	Picture by picture (split screen) mode, with keep aspect.	
PICTURE BY PICTURE-FULL	Picture by picture (split screen) mode, with full screen.	
SUB INPUT	Selects sub picture input signal.	Depends on signal input
PIP SIZE	Determines the size of the sub-picture used in Picture-in-Picture (PIP) mode. Press the SET/POINT ZOOM button to adjust. Press + or CH+ to expand. Press - or CH- to reduce. It is also possible to change the sub-picture size by pressing the SET/POINT ZOOM button when the sub-picture is shown.	37
PIP POSITION	Determines the location where the PIP appears on the screen.	X = 95, Y = 92
ASPECT	Selects sub picture aspect, [FULL], [NORMAL] and [WIDE]. See page 17.	FULL

*1: This function depends on which option board you use.

TEXT TICKER			OFF
MODE	Enables Text Ticker and allows you to set Horizontal or Vertical direction.		
POSITION	Selects the location of the Text Ticker on the screen.		
SIZE	Determines the size of the Text Ticker in relationship to the overall screen size.		
BLEND	Sets the transparency of the Text Ticker (0: transparent, 100: opaque).		
DETECT	Enables auto-detection of the Text Ticker.		
FADE IN	Enables fade-in of the text ticker.		
RESET	Resets PIP options back to factory settings except SUB INPUT and ASPECT.		-
OSD			
LANGUAGE		Select the language used by the OSD.	ENGLISH (Depends on destination)
ENGLISH			
DEUTSCH			
FRANÇAIS			
ITALIANO			
ESPAÑOL			
SVENSKA			
РУССКИЙ			
中文			
日本語			
MENU DISPLAY TIME	Turns off the OSD after a period of inactivity. The preset choices are 10-240 seconds.		30 SEC.
OSD POSITION		Determines the location where the OSD appears on the screen.	X = 128, Y = 225
UP			
DOWN			
RIGHT			
LEFT			
INFORMATION OSD	Selects whether the information OSD is displayed or not. The information OSD will be displayed when the input signal or source changes. The information OSD will also give a warning when there is no-signal or the signal is out-of range. An interval between 3 to 10 seconds for the Information OSD to appear is available.		ON, 3 SEC.
MONITOR INFORMATION	Indicates the model and serial number of your monitor and firmware version. CARBON SAVINGS: Display the estimated carbon saving information in kg-CO ₂ . The carbon footprint factor in the carbon saving calculation is based on the OECD (2008 Edition). CARBON USAGE: Display the estimated carbon usage information in kg-CO ₂ . This is the arithmetic estimation, not actual measurement value. This estimation is based without any options.		-
OSD TRANSPARENCY	Set the transparency of the OSD.		OFF
OSD ROTATION		Determines the OSD display direction between landscape and portrait.	LANDSCAPE
LANDSCAPE	Display the OSD with landscape mode.		
PORTRAIT	Display the OSD with portrait mode.		
INPUT NAME	You can create a name for the INPUT currently being used. Max: 8 characters, including Space, A-Z, 0-9, and some symbols.		-
MEMO	Sets a title and message via HTTP server. See page 44.		-
RESET	Resets the following settings within the OSD menu back to factory setting: MENU DISPLAY TIME, OSD POSITION, INFORMATION OSD, OSD TRANSPARENCY.		-

MULTI DISPLAY

ID CONTROL	Sets the monitor ID number from 1-100 and group ID from A-J. DETECTED MONITORS shows the number of all monitors which follow in the chain with LAN. NOTE: Group ID is made of multiple selections.	1
AUTO ID/IP SETTING	When "SET" is selected, AUTO ID/IP SETTING window is shown. Do not connect network devices between the monitors connected with LAN.	
SETTING ITEM	Select an item from [MONITOR ID], [IP ADDRESS] and [ID and IP].	MONITOR ID
ID/IP SETTING START	When "YES" is set, selected item at SETTING ITEM is set.	
MONITOR ID	When "YES" is set, monitor ID numbers are set automatically to the all monitors.	
IP ADDRESS	Set the first octet to the third octet at "BASE ADDRESS". The fourth octet is automatically set from "1" and counting up till the number of monitors connected with LAN. "BASE ADDRESS" is shown when "IP ADDRESS" or "ID and IP" is selected at SETTING ITEM.	
ID and IP	Set "MONITOR ID" and "IP ADDRESS".	
DETECTED MONITORS	This item is shown after "SETTING ITEM" is selected and "ID/IP ADDRESS START" is set to "YES". The number of monitors which MONITOR ID is given is shown. If the shown number and actual monitor number which MONITOR ID is given are different, select "RETRY" to recount monitors. Select "CONTINUE" when "FINISH!!" is displayed. If "CONTINUE" is not selected after "FINISH!!" is displayed, the settings that have been made will be invalid and will not be reflected.	
AUTO ID/IP RESET	When "RESET" is selected, AUTO ID/IP RESET window is shown.	
RESET ITEM	Select a setting from [MONITOR ID], [IP ADDRESS], and [ID and IP].	MONITOR ID
ID/IP RESET START	When "YES" is set, the setting of selected item at RESET ITEM returns to default setting. When the setting returns to default setting, "FINISH!!" is displayed. After "ID/IP RESET START" is activated, "MONITOR ID" and "IP ADDRESS" settings will be individual settings even though monitors are connected with LAN. NOTE: When the number of monitors connected with LAN was changed, please select the same item that you selected at "SETTING ITEM" and then run the "AUTO ID/IP RESET".	
COMMAND TRANSFER	When "ON" is set, command is sent to all the monitors which follow in the chain with LAN. NOTE: The all monitors connected with LAN should be "ON". When executing this function in standby mode or power save mode, "LAN POWER" should be "ON". Do not turn off the monitors while AUTO ID/IP SETTING or AUTO ID/IP RESET is activating.	ON
IR LOCK SETTINGS	Prevents the monitor from being controlled by the wireless remote control. When ACTIVATE is selected, all the settings are activated. NOTE: IR LOCK SETTINGS is a function intended only to the wireless remote control buttons. This function does not lock out access to all buttons at the back of the monitor. To return to normal operation, press the "DISPLAY" button on the remote control for 5 seconds.	UNLOCK
MODE SELECT	Selects the mode UNLOCK, ALL LOCK or CUSTOM LOCK.	
UNLOCK	All buttons on the remote control are available for normal operations.	
ALL LOCK	Locks all remote control buttons.	
CUSTOM LOCK	Selects which buttons to be locked from POWER, VOLUME, and INPUT button. Except for CUSTOM LOCK settings, other buttons on the remote control are locked. POWER: When LOCK is selected, POWER button is locked. VOLUME: When UNLOCK is selected, sets minimum and maximum volume between VOL.0 to VOL.100. VOLUME (+) button and VOLUME (-) buttons are only available from the minimum volume to the maximum volume you set. When LOCK is selected, VOLUME (+) button and VOLUME (-) buttons are locked. INPUT: When UNLOCK is selected, choose up to three buttons from DVI, DisplayPort, VGA, HDMI, Y/Pb/Pr, VIDEO*1, S-VIDEO*1, OPTION*1 which you prefer to be unlocked. The unselected buttons are locked. When LOCK is selected, all INPUT buttons are locked.	

*1: This function depends on which option board you use.

TILE MATRIX	Allows one image to be expanded and displayed over multiple screens (up to 100) through a distribution amplifier. NOTE: Low resolution is not suitable for tiling to a large number of monitors. You can operate without a distribution amplifier at a lower number of screens. This function is released when selecting IMAGE FLIP except for NONE. NOTE: Dynamic or Zoom will not work when Tile Matrix is activated. When “DYNAMIC” or “ZOOM” is selected in ASPECT while executing TILE MATRIX, the setting will be applied after completing of TILE MATRIX.	
H MONITORS	Number of monitors arranged horizontally.	1
V MONITORS	Number of monitors arranged vertically.	1
POSITION	Select which section of the tiled image to be displayed on the monitor.	1
TILE COMP	Turns the TILE COMP feature on.	NO
TILE MATRIX ENABLE	Enables Tile Matrix.	NO
FRAME COMP	Sets the tiled image timing to be displayed on the monitor. Large number makes large influence to displayed image. NOTE: The image may be distorted when turning the power on or changing the settings.	NONE
NONE	FRAME COMP is not available.	
AUTO	Sets display timing to vertical direction of all monitors automatically.	
MANUAL	Sets display timing to individual monitor.	
V SCAN REVERSE*1	Reverse scanning image direction. Normal scanning direction is top to bottom. NOTE: If V SCAN REVERSE is set to AUTO or MANUAL, FRAME COMP is not available.	NONE
NONE	V SCAN REVERSE is not available.	
AUTO	Sets automatically calculated image scanning direction to all monitors.	
MANUAL	Sets scanning direction to individual monitor.	
NON REVERSE	Sets normal scanning direction and delays 1 frame display image timing.	
REVERSE	Reverse scanning direction to individual monitor.	
TILE MATRIX MEM	When “INPUT” is selected, TILE MATRIX setting is applied to each signal input.	COMMON
AUTO TILE MATRIX SETUP	Allows auto setting of multiple screens by inputting the number of monitors arranged horizontally and vertically on the primary monitor. Following settings are set automatically: MONITOR ID, TILE MATRIX, TILE MATRIX MEM, Input Signal, VIDEO OUT SETTING, DisplayPort in TERMINAL SETTING. NOTE: All monitors which follow in the chain with LAN should be ON. When executing this function while in standby mode or power save mode, “LAN POWER” should be set to ON. AUTO ID will be automatically executed. When you use this function, it is recommended that monitors are chained by DisplayPort cable. Example of installation via LAN: H MONITORS 3 V MONITORS 3	DEACTIVATE
POWER ON DELAY	Adjusts the delay time between being in “standby” mode and entering “power on” mode.	
DELAY TIME	“POWER ON DELAY” can be set between 0 and 50 seconds.	0 SEC.
LINK TO ID	When “ON” selected, delay time is linked with Monitor ID. It takes more time as larger ID number.	OFF

*1: Except for UN551S/UN551VS.

VIDEO OUT SETTING	<p>Enables the signal output from DPORT. See also page 28 "DisplayPort" in TERMINAL SETTING. NOTE: When VGA or Y/Pb/Pr is selected as the main picture, nothing will be output from DPORT. When this function is ON, DPORT cannot be selected as the sub picture. When this function is ON, INPUT CHANGE is limited to be NORMAL or QUICK. When this function is ON and DPORT is selected as the main picture, PIP CHANGE button of remote control (see page 11) is disabled.</p> <table border="1"> <thead> <tr> <th>Input signal name^{*1}</th> <th>DPORT</th> <th>DVI</th> <th>HDMI</th> <th>VGA</th> <th>Y/Pb/Pr</th> <th>OPTION</th> <th>VIDEO</th> <th>S-VIDEO</th> <th>SCART</th> <th>Y/Pb/Pr2</th> <th>RGB/HV</th> <th>HDMI2</th> <th>HDMI3</th> </tr> </thead> <tbody> <tr> <td>Connector</td> <td>DisplayPort</td> <td>DVI-D</td> <td>HDMI</td> <td>D-Sub</td> <td></td> <td>SLOT2</td> <td></td> <td></td> <td></td> <td colspan="4">SLOT3</td> </tr> <tr> <td>DP OUT</td> <td>Yes</td> <td>Yes</td> <td>Yes</td> <td>—</td> <td>—</td> <td>Yes</td> <td>—</td> <td>—</td> <td>—</td> <td>— (SB3-AB1)</td> <td>Yes (SB3-AB2)</td> <td>Yes</td> <td>—^{*2}</td> <td>—^{*2}</td> </tr> </tbody> </table> <p>^{*1}: Main picture in PIP (Picture in Picture) mode. ^{*2}: When you use HDMI OUT connector in SB3-DB1, multiple monitors connection is available. When you use DPOUT for HDCP authentication signal, Input signal name should be DPORT. Multiple monitors that are daisy-chained have a limit to the connectable monitors.</p>	Input signal name ^{*1}	DPORT	DVI	HDMI	VGA	Y/Pb/Pr	OPTION	VIDEO	S-VIDEO	SCART	Y/Pb/Pr2	RGB/HV	HDMI2	HDMI3	Connector	DisplayPort	DVI-D	HDMI	D-Sub		SLOT2				SLOT3				DP OUT	Yes	Yes	Yes	—	—	Yes	—	—	—	— (SB3-AB1)	Yes (SB3-AB2)	Yes	— ^{*2}	— ^{*2}	ON
Input signal name ^{*1}	DPORT	DVI	HDMI	VGA	Y/Pb/Pr	OPTION	VIDEO	S-VIDEO	SCART	Y/Pb/Pr2	RGB/HV	HDMI2	HDMI3																																
Connector	DisplayPort	DVI-D	HDMI	D-Sub		SLOT2				SLOT3																																			
DP OUT	Yes	Yes	Yes	—	—	Yes	—	—	—	— (SB3-AB1)	Yes (SB3-AB2)	Yes	— ^{*2}	— ^{*2}																															
POWER INDICATOR	<p>Turns ON or OFF the LED located at the back of the monitor. If "OFF" is selected, LED will not light when the LCD monitor is in active mode.</p>	ON																																											
SETTING COPY	<p>In a daisy chain scenario, select the OSD menu categories that you want to copy over to the other monitor. NOTE: When you use this function, monitors should be daisy chained by LAN. This function resets to default when power is off. This function has a limit depending on the cable you use.</p>	NO																																											
	COPY START	Select "YES" and press the SET button to start copying.																																											
	ALL INPUT	All input terminals settings are copied when you select this item. Default is off.																																											
RESET	Resets "MULTI DISPLAY" options back to factory settings except for POWER ON DELAY and VIDEO OUT SETTING.	-																																											
DISPLAY PROTECTION																																													
POWER SAVE	<p>Sets how long the monitor waits to go into power save mode after the signal is lost. NOTE: When connecting DVI, the display card might not stop sending the digital data even though the image might have disappeared. If this occurs the monitor will not switch into power management mode. POWER SAVE is disabled when AUTO OFF or CUSTOM is selected in HUMAN SENSING.</p>	AUTO STANDBY																																											
	AUTO POWER SAVE	The monitor automatically goes into OFF at the preset time period after signal is lost. The monitor will return to normal mode when signal is restarted.	-																																										
	AUTO STANDBY	The monitor automatically goes into OFF at the preset time period after signal is lost. Press the power button to return to normal mode.	-																																										
	DISABLE	The monitor will not go into OFF after signal is lost.	-																																										
HEAT STATUS	Displays status of the FAN, BACKLIGHT and TEMPERATURE.	-																																											
FAN CONTROL	<p>Cooling fan reduces the temperature of the display to protect from overheating. If "AUTO" is selected, you can adjust the start temperature of the cooling fan and fan speed.</p>	AUTO, HIGH																																											
SCREEN SAVER	Use the SCREEN SAVER function to reduce the risk of Image Persistence.																																												
	GAMMA	The display gamma is changed and fixed when "ON" is selected.	OFF																																										
	BACKLIGHT	The brightness of backlight is decreased when "ON" is selected. NOTE: Do not select this function when ROOM LIGHT SENSING is MODE1 or MODE2.	OFF																																										
	MOTION	The screen image is slightly expanded and moves in 4 directions (UP, DOWN, RIGHT, LEFT) at user determined intervals. You can set interval time and zooming ratio. This function is disabled when PIP, STILL, TEXT TICKER or TILE MATRIX are enabled.	OFF																																										
SIDE BORDER COLOR	<p>Adjusts the color of the side borders when a 4:3 image is displayed. Press + button, the bar will become lighter. Press - button, the bar will become darker.</p>	15																																											
CHANGE PASSWORD	<p>Allows the security password to be changed. The factory preset password is 0000.</p>	-																																											
SECURITY	<p>Locks the security password. START-UP LOCK: Security password is required when the monitor power is on. CONTROL LOCK: Security password is required when the remote control button or control button on the monitor is pressed. BOTH LOCK: Security password is required when the monitor power is on, or the remote control button or control button on the monitor is pressed.</p>	OFF																																											
RESET	Resets the following settings within the DISPLAY PROTECTION menu back to factory setting: POWER SAVE, FAN CONTROL, SCREEN SAVER, SIDE BORDER COLOR.	-																																											

EXTERNAL CONTROL		
IP ADDRESS SETTING	NOTE: When changing the LAN SETTING, you need to wait several seconds until the LAN SETTING is applied.	
IP SETTING	Enabling this option automatically assigns an IP address to the monitor from your DHCP server. Disabling this option allows you to register the IP address or subnet mask number obtained from your network administrator. NOTE: Consult your network administrator for the IP address when "AUTO" is selected for [IP SETTING].	AUTO
IP ADDRESS	Set your IP address of the network connected to the monitor when "MANUAL" is selected for [IP SETTING].	192.168.0.10
SUBNET MASK	Set your subnet mask number of the network connected to the monitor when "MANUAL" is selected for [IP SETTING].	255.255.255.0
DEFAULT GATEWAY	Set your default gateway of the network connected to the monitor when "MANUAL" is selected for [IP SETTING]. NOTE: Set as [0.0.0.0] to delete the setting.	0.0.0.0
DNS	Set for IP ADDRESS SETTING of DNS server. AUTO: Automatically assign an IP address of DNS server connected to the monitor. MANUAL: Set your IP address of DNS server connected to the monitor.	AUTO
DNS PRIMARY	Set your primary DNS settings of the network connected to the monitor. NOTE: Set as [0.0.0.0] to delete the setting.	0.0.0.0
DNS SECONDARY	Set your secondary DNS settings of the network connected to the monitor. NOTE: Set as [0.0.0.0] to delete the setting.	0.0.0.0
MAC ADDRESS	Displays the MAC ADDRESS.	-
LAN POWER	Selects LAN operation mode. When "ON" selected, allows to supply power to LAN during power save mode or standby mode. NOTE: For enabling "AUTO ID" or "AUTO TILE MATRIX SETUP", this function should be ON.	OFF
DDC/CI	ENABLE/DISABLE: Turns ON or OFF the two way communication and control of the monitor.	ENABLE
PING	Confirm the response by communicating to the preset IP address.	192.168.0.10 NO
IP ADDRESS RESET	Resets IP ADDRESS SETTING back to factory settings.	NO
RESET	Resets the following setting within the EXTERNAL CONTROL menu back to factory settings: DDC/CI.	-
ADVANCED OPTION1		
INPUT DETECT	Selects the method of input detection the monitor uses when more than two input devices are connected. NOTE: When SUPER is selected in INPUT CHANGE, this function cannot be changed.	NONE
NONE	The Monitor will not search the other video input ports.	
FIRST DETECT*2	When the current video input signal is not present, then the monitor searches for a video signal from the other video input port. If the video signal is present in the other port, then the monitor switches the video source input port to the new found video source automatically. The monitor will not look for other video signals while the current video source is present.	
LAST DETECT*2	When the monitor is displaying a signal from the current source and a new secondary source is supplied to the monitor, the monitor will automatically switch to the new video source. When current video input signal is not present, the monitor searches for a video signal from the other video input port. If the video signal is present in the other port, then the monitor switches the video source input port to the new found video source automatically.	
VIDEO DETECT	VIDEO inputs such as HDMI, HDMI2*1, HDMI3*1, Y/Pb/Pr, Y/Pb/Pr2*1, SCART*1, VIDEO*1 or S-VIDEO*1 will have priority over DVI, VGA, DPORT, RGB/HV*1. When one of the VIDEO input signals is present the monitor will change and keep to the VIDEO input.	
CUSTOM DETECT	Set the priority of input signals. When CUSTOM DETECT is selected, monitor searches listed inputs only. NOTE: Priority of option input signal is only available in PRIORITY3 except for slot 2 type PC option.	

*1: This function depends on which option board you use.

*2: Only for DVI, DPORT, VGA, RGB/HV*1, HDMI, HDMI2*1, HDMI3*1 input.

LONG CABLE COMP*1 (Analog input only)		Manually compensates for image degradation caused from using a long cable.	
	ON/OFF	ON: Activates this function. OFF: Deactivates this function.	OFF
	SOG PEAK	Adjusts the sensitivity of the Sync On Green input signals. Adjusts the slice level when separating synchronization from sync On Green signal input. Press "LEFT" or "RIGHT" to select.	0
	GAIN	Adjusts gain value.	0
	R-H.POSITION	Adjusts the position of the red component of the image.	0
	G-H.POSITION	Adjusts the position of the green component of the image.	0
	B-H.POSITION	Adjusts the position of the blue component of the image.	0
	SYNC TERMINATION	Selects the terminate resistance for matching the cable impedance.	HIGH
INPUT CHANGE		Sets input change speed. When selected "SUPER", allows to switch high-speed between set two signals. NOTE: When "QUICK" is selected, picture may be distorted when signal input is changed. "SUPER" is released when selecting IMAGE FLIP except for NONE. This function should be chosen after all adjustment options have been made for the input.	NORMAL
TERMINAL SETTING			
	DVI MODE	Selects the kind of DVI-D equipment which is connected to the DVI input. Select "DVI-HD" when DVD player or computer equipment, which requires HDCP authentication, is connected. Select "DVI-PC" when a computer equipment, which not requires HDCP authentication, is connected.	DVI-HD
	D-SUB MODE	Selects the type of signal associated with the D-SUB input. RGB: Analog input (R, G, B, H, V) COMPONENT: Component (Y, Cb/Pb, Cr/Pr)	RGB
	BNC MODE*1	Selects the kind of equipment which is connected to the BNC input. RGB: Analog input. COMPONENT: Component.	RGB
	SCART MODE*1	Input mode for devices using SCART connectors.	OFF
	DisplayPort	Selects DisplayPort mode [1.1a] or [1.2]. [1.2] should be selected when using Multi-Stream Transport.*2	1.1a
	HDMI SIGNAL	RAW: Disable the expanded feature. EXPAND: Expand image contrast and increase detail in the dark and bright areas.	Depends on signal input
DEINTERLACE		Selects the IP (Interlace to Progressive) conversion function. NOTE: For DVI input "DVI-HD" needs to be enabled in the DVI mode menu. When INPUT2 of SUPER is selected in INPUT CHANGE and displayed, this function cannot be changed.	ON
	ON	Converts interlaced signals to progressive. This is the default setting.	
	OFF	Disables IP conversion. This setting is best suited for motion pictures, but increases the risk of image retention.	

*1: This function depends on which option board you use.

*2: Multi-Stream Transport requires the corresponding display card. Contact your dealer for limitations of this function.

COLOR SYSTEM *1 <small>VIDEO, S-VIDEO inputs only</small>		The selected Color System depends on the video format of the input signal.	AUTO						
<table border="1"> <tr><td>AUTO</td></tr> <tr><td>NTSC</td></tr> <tr><td>PAL</td></tr> <tr><td>SECAM</td></tr> <tr><td>4.43 NTSC</td></tr> <tr><td>PAL-60</td></tr> </table>		AUTO	NTSC	PAL	SECAM	4.43 NTSC	PAL-60	Automatically chooses Color System setting based on input signal.	
AUTO									
NTSC									
PAL									
SECAM									
4.43 NTSC									
PAL-60									
OVER SCAN <small>HDMI, Y/Pb/Pr, SCART*1, VIDEO*1, S-VIDEO*1, HDMI2*1, HDMI3*1 inputs only</small>		Some video formats may require different scanning modes in order to best display the image.	ON						
<table border="1"> <tr><td>ON</td></tr> <tr><td>OFF</td></tr> </table>		ON	OFF	<p>Image size is larger than what can be displayed. The image edge will appear cropped. Approximately 95% of the image will be shown on the screen.</p> <p>Image size stays within the display area. The whole image is displayed on the screen. NOTE: When you use a computer with HDMI out, please set "OFF".</p>					
ON									
OFF									
OPTION SETTING			-						
OPTION POWER		Allow the monitor to supply power to Option board slot during power save mode or standby mode. NOTE: This function should be set to ON when using power save management by slot 2 type option.	OFF						
AUDIO *1		Selects sound input signal according to slot2 type option's specifications. To activate DIGITAL, select OPTION for input signal and OPTION for AUDIO INPUT. NOTE: DIGITAL is activated only when OPTION is selected for input signal and OPTION for AUDIO INPUT.	ANALOG						
INTERNAL PC *1		The function is available for slot 2 type PC.							
OFF WARNING		If OPTION POWER is OFF, a warning message appears when monitor power is turned off. NOTE: Warning message does not appear when monitor power is turned off by OFF TIMER setting or SCHEDULE setting.	OFF						
AUTO OFF		Monitor power is automatically "OFF" when connected PC is OFF or the monitor is in power save mode. NOTE: Monitor power is not automatically "ON" when connected PC is ON.	OFF						
START UP PC		When ON is selected, connected PC start-up.	NO						
FORCE QUIT		When ON is selected, it performs force-quit PC. Please use this function only when the operating system cannot be shut down manually.	NO						
120Hz <small>(not adjustable)</small>			-						
TOUCH PANEL <small>(not adjustable)</small>			-						
RESET		Resets the following settings within the ADVANCED OPTION menu back to factory setting: INPUT DETECT (except the priority of input signals), INPUT CHANGE (except for INPUT1 and INPUT2), TERMINAL SETTING, DEINTERLACE, COLOR SYSTEM, OVER SCAN, AUDIO in OPTION SETTING.	-						

*1: This function depends on which option board you use.

ADVANCED OPTION2

AUTO DIMMING	Adjusts the backlight of the LCD automatically depending on the amount of ambient light.	-
AUTO BRIGHTNESS <small>DPORT, DVI, VGA, RGB/HV** inputs only</small>	Adjusts the brightness level according to the input signal. NOTE: Do not select this function when ROOM LIGHT SENSING is MODE1 or MODE2.	OFF
ROOM LIGHT SENSING*2	<p>The backlight of the LCD screen can be set to increase or decrease depending on the amount of ambient light within the room. If the room is bright, the monitor will dim accordingly. The purpose of this function is to make the viewing experience more comfortable to the eye in a variety of lighting conditions.</p> <p>NOTE: When ROOM LIGHT SENSING is set to MODE1 or MODE2, BACKLIGHT, AUTO BRIGHTNESS and BACKLIGHT in SCREEN SAVER function are disabled. Do not cover the room light sensing sensor when you use MODE1 or MODE2.</p> <p>AMBIENT parameter setting ROOM LIGHT SENSING in OSD, select MODE1 or MODE2 and set MAX LIMIT, IN BRIGHT and IN DARK in each mode. MAX LIMIT: This is the max level of backlight which you set. IN BRIGHT: This is the backlight level that the monitor will go up to when the ambient light level is highest. IN DARK: This is the level of backlight that the monitor will go down to when the ambient light level is low. When the ROOM LIGHT SENSING is enabled the Backlight level of the screen changes automatically according to the lighting conditions of the room (see figure below).</p> <div data-bbox="475 734 1244 1108" data-label="Figure"> <p>The graph plots backlight level (0% to 100%) against room bright condition (dark to bright). Two lines represent MODE1 (dotted) and MODE2 (solid). MODE1 has a higher 'IN BRIGHT' level and a lower 'IN DARK' level compared to MODE2. Labels include 'Factory Setting', 'BACKLIGHT range', 'BACKLIGHT range when set to MAX LIMIT', and 'BACKLIGHT level set for the monitor to use when ambient lighting level is low/high'.</p> </div> <p>MAX LIMIT: BACKLIGHT level is limited to your set level. IN DARK: BACKLIGHT level set for the monitor to use when ambient lighting level is low. IN BRIGHT: BACKLIGHT level set for the monitor to use when ambient lighting level is high.</p>	OFF
HUMAN SENSING*2	HUMAN SENSING has three settings. NOTE: POWER SAVE is disabled when AUTO OFF or CUSTOM is selected in HUMAN SENSING.	DISABLE
DISABLE	No human sensing.	-
AUTO OFF	At the preset time, when no person is detected, BACKLIGHT and VOLUME automatically go into OFF. When a person comes near the monitor again, the monitor will automatically return to normal mode.	-
CUSTOM	BACKLIGHT and VOLUME automatically shift to the set value when detecting no person. When a person comes near the monitor again, the monitor automatically return to normal mode and display the input signal selected in INPUT SELECT.	-
INTELLI. WIRELESS DATA	Select "ON" to activate INTELLIGENT WIRELESS DATA function (see page 46). A password is required when using the function.	ON
RESET	Resets "ADVANCED OPTION 2" settings back to factory setting, except for INTELLI. WIRELESS DATA.	-
FACTORY RESET	All items are returned to factory shipment state. NOTE: You can reset all items in all daisy chain displays. Please be careful to avoid resetting all items inadvertently.	-

*1: This function depends on which option board you use.

*2: The function is available only when connecting the optional sensor unit.

NOTE 1: CREATING A SCHEDULE

The schedule function allows the display to be set to power on and off at different times. Up to seven different schedules can be programmed.

To program the schedule:

1. Enter the SCHEDULE menu. Highlight SCHEDULE SETTINGS using the up and down buttons. Press the SET/POINT ZOOM or the + button to enter the Settings menu. Highlight the desired schedule number and press SET/POINT ZOOM. The box next to the number will turn yellow. The schedule can now be programmed.
2. Use the down button to highlight the hours setting in the ON time slot. Use the + and - buttons to set the hour. Use the up and down buttons to highlight the minutes setting. Use the + and - buttons to set the minutes. Set the OFF time in the same manner.
3. Use the up and down arrows to highlight INPUT. Use the + and - buttons to choose the input source. Use the up and down arrows to highlight PIC. MODE. Use the + and - buttons to choose the picture mode.
4. Use the down button to select a day on which the schedule will be enabled. Push the SET/POINT ZOOM button to enable. If the schedule is to be ran every day, choose EVERY DAY and press the SET/POINT ZOOM button. The circle next to EVERY DAY will turn yellow. If a weekly schedule is desired, choose the days of the week using the up and down buttons and pressing SET/POINT ZOOM to select. Then highlight the EVERY WEEK option and press SET/POINT ZOOM.
5. After a schedule is programmed the remaining schedules can then be set. Press MENU to leave the OSD or press EXIT to go back to the previous menu.

NOTE: If schedules are overlapping then the schedule with the highest number will have priority over the schedule with the lowest number. For example schedule #7 will have priority over schedule #1.

If selected input or picture mode is not available now, disable input or picture mode is shown in red.

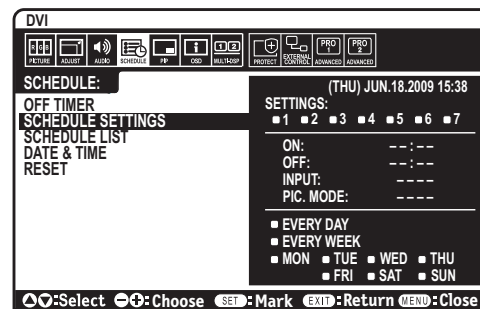

NOTE 2: IMAGE PERSISTENCE

Please be aware that LCD Technology may experience a phenomenon known as Image Persistence. Image Persistence occurs when a residual or “ghost” image of a previous image remains visible on the screen. Unlike CRT monitors, LCD monitors’ image persistence is not permanent, but constant images being displayed for a long period of time should be avoided.

To alleviate image persistence, turn off the monitor for as long as the previous image was displayed. For example, if an image was on the monitor for one hour and a residual image remains, the monitor should be turned off for one hour to erase the image.

As with all personal display devices, NEC DISPLAY SOLUTIONS recommends displaying moving images and using a moving screen saver at regular intervals whenever the screen is idle or turning off the monitor when not in use.

Please set “SCREEN SAVER”, “DATE & TIME” and “SCHEDULE SETTINGS” functions to further reduce the risk of Image persistence.

For long life use as Public Display

Image Sticking of LCD Panel

When an LCD panel is operated continuously for long hours, a trace of electric charge remains near the electrode inside LCD, and residual or “ghost” image of previous image may be observed. (Image Persistence)

Image Persistence is not permanent, but when fixed image is displayed for long period, ionic impurities inside LCD are accumulated along the displayed image, and may be permanent. (Image Sticking)

Recommendations

To prevent Image Sticking, and for longer life usage of LCD, the following are recommended.

1. Fixed image should not be displayed for long period. Change fixed images after short intervals.
2. When not in use, please turn off the monitor by remote control, or use Power Management or use Schedule Functions.
3. Lower environmental temperatures prolong the lifespan of the monitor.

When Protective surface (glass, acrylic) is installed over the LCD surface, the LCD surface is located in an enclosed space, the monitor are stacked, utilize the temperature sensors inside monitor.

To reduce the environmental temperature, use the Cooling Fan, Screen Saver and Low Brightness.
4. Please use “Screen Saver Mode” of monitor.

Remote Control Function

REMOTE CONTROL ID FUNCTION

REMOTE CONTROL ID

The optional remote control can be used to control up to 100 individual MultiSync monitors using what is called the REMOTE CONTROL ID mode. The REMOTE CONTROL ID mode works in conjunction with the Monitor ID, allowing control of up to 100 individual MultiSync monitors. For example: if there are many monitors being used in the same area, a remote control in normal mode would send signals to every monitor at the same time (see Figure 1). Using the remote in REMOTE CONTROL ID mode will only operate one specific monitor within the group (see Figure 2).

TO SET REMOTE CONTROL ID

While holding down the REMOTE ID SET button on the remote control, use the KEYPAD to input the Monitor ID (1-100) of the display to be controlled via remote. The remote can then be used to operate the monitor having that specific Monitor ID number.

When 0 is selected or when the remote control is in normal mode, all monitors will be operated.

TO SET/RESET REMOTE CONTROL MODE

ID Mode - To enter ID Mode press the REMOTE ID SET button and hold down for 2 seconds.

Normal Mode - To return to Normal Mode press the REMOTE ID CLEAR button and hold down for 2 seconds.

In order for this feature to work properly, the display must be assigned a Monitor ID number. The Monitor ID number can be assigned under the MULTI DISPLAY menu in the OSD (See page 24).

Point the remote control towards the remote sensor of the desired monitor and press the REMOTE ID SET button. The MONITOR ID number is shown on the display when your remote control is in ID mode.

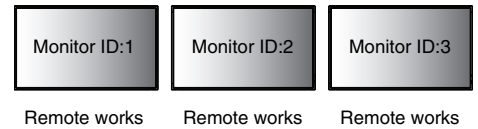

Figure 1
Remote in Normal mode or the REMOTE ID is set to 0

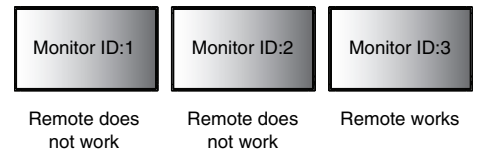
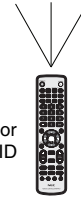
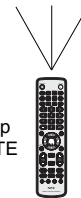

Figure 2
Remote set up to use REMOTE ID:3



You need an optional remote control for this function.

Use the remote control to operate a monitor that has a specific MONITOR ID number assigned to it.

1. Set the MONITOR ID number for the display (See page 24). The MONITOR ID number can range from 1-100. This MONITOR ID number allows the remote control to operate this specific monitor without affecting other monitors.
2. On the remote control, press and hold down the REMOTE ID SET button while using the keypad to input the REMOTE CONTROL ID number (1-100). The REMOTE ID NUMBER should match the MONITOR ID number of the display to be controlled. Choose "0" to simultaneously control all displays in range.
3. Point the remote control towards the remote sensor of the desired monitor and press the REMOTE ID SET button. The MONITOR ID number is shown in red on the display. If the REMOTE CONTROL ID is "0", then all displays in range will show their respective MONITOR ID number in red.

If the MONITOR ID number is shown in white on the display, the MONITOR ID number and the REMOTE CONTROL ID are not the same.

NOTE: GROUP ID cannot be specified via the remote control.

Multiple Monitors Connection

You can control multiple monitors by using RS-232C, REMOTE IN or LAN daisy-chain connection.

NOTE: Multiple monitors that are daisy-chained have a limit to the connectable monitors.
When manually specify the ID number or control by the specified ID number, please execute AUTO ID (see page 24) previously.

Main Monitor		Sub Monitors	
Connector		Connector	
IN	OUT	IN	OUT
RS-232C	LAN2	LAN1	LAN2
REMOTE IN			
LAN1			

Connection

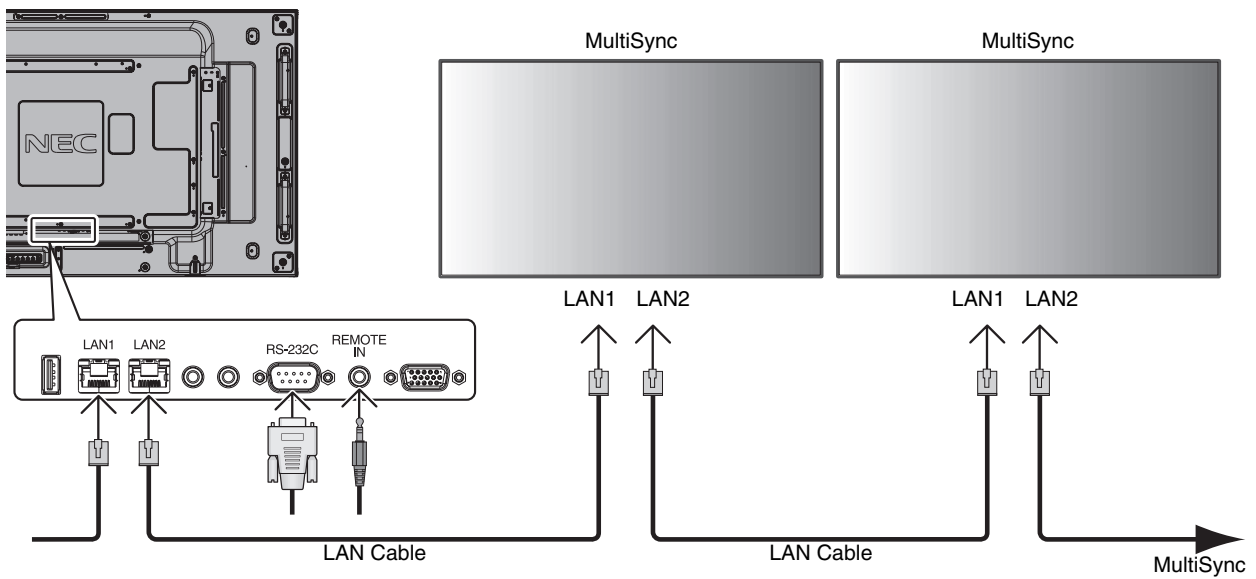

Controlling the LCD monitor via RS-232C Remote Control

This LCD monitor can be controlled by connecting a personal computer with a RS-232C terminal.

Functions that can be controlled by a personal computer are:

- Power ON or OFF.
- Switching between input signals.
- Sound Mute ON or OFF.

Connection

LCD Monitor + computer

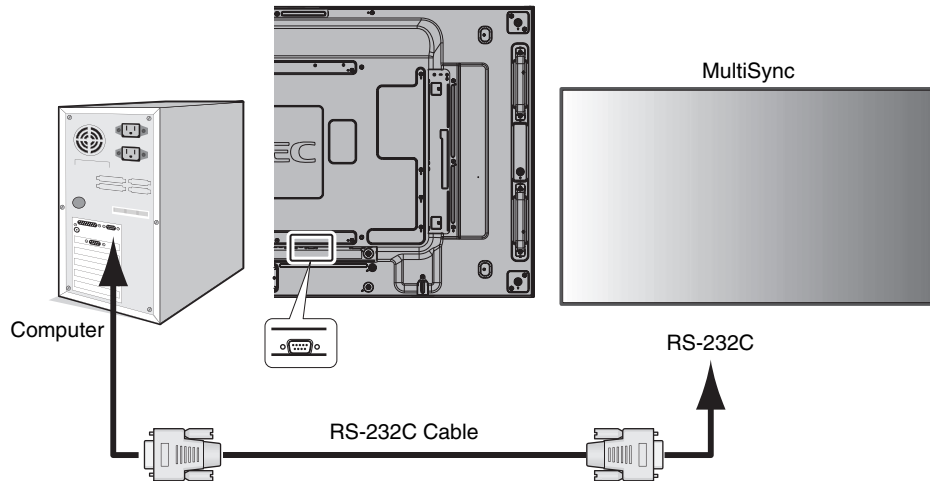

NOTE: If your computer is equipped only with a 25-pin serial port connector, a 25-pin serial port adapter is required. Contact your dealer for details.
For the pin assignment, please see page 53 "2) RS-232C input/output".

To control a monitor, please use the control command. Instructions for the control command can be found on the CD included with the display. The file is called "External_control.pdf".

1) Interface

PROTOCOL	RS-232C
BAUD RATE	9600 [bps]
DATA LENGTH	8 [bits]
PARITY BIT	NONE
STOP BIT	1 [bit]
FLOW CONTROL	NONE

This LCD monitor uses RXD, TXD and GND lines for RS-232C control.

The reverse type cable (null modem cable) (not include) should be used for RS-232C control.

2) Control command diagram

For other commands, please see "External_Control.pdf" file on the CD-ROM.

Function (Monitor ID = 1)	Code Data
Power ON	01 30 41 30 41 30 43 02 43 32 30 33 44 36 30 30 30 31 03 73 0d
Power OFF	01 30 41 30 41 30 43 02 43 32 30 33 44 36 30 30 30 34 03 76 0d
Input Source Select DisplayPort	01 30 41 30 45 30 41 02 30 30 36 30 30 30 30 46 03 04 0d
Input Source Select DVI	01 30 41 30 45 30 41 02 30 30 36 30 30 30 30 33 03 71 0d
Input Source Select VGA	01 30 41 30 45 30 41 02 30 30 36 30 30 30 30 31 03 73 0d
Input Source Select HDMI	01 30 41 30 45 30 41 02 30 30 36 30 30 30 31 31 03 72 0d
Input Source Select Y/Pb/Pr	01 30 41 30 45 30 41 02 30 30 36 30 30 30 30 43 03 01 0d
Input Source Select VIDEO	01 30 41 30 45 30 41 02 30 30 36 30 30 30 30 35 03 77 0d
Input Source Select S-VIDEO	01 30 41 30 45 30 41 02 30 30 36 30 30 30 30 37 03 75 0d
Input Source Select OPTION	01 30 41 30 45 30 41 02 30 30 36 30 30 30 30 44 03 06 0d
Sound Mute ON	01 30 41 30 45 30 41 02 30 30 38 44 30 30 30 31 03 09 0d
Sound Mute OFF	01 30 41 30 45 30 41 02 30 30 38 44 30 30 30 32 03 0a 0d

Controlling the LCD monitor via LAN Control

Connecting to a Network

Using a LAN cable allows you to specify the Network Settings and the Alert Mail Settings by using an HTTP server function.

To use a LAN connection, you are required to assign an IP address.

Example of LAN connection:

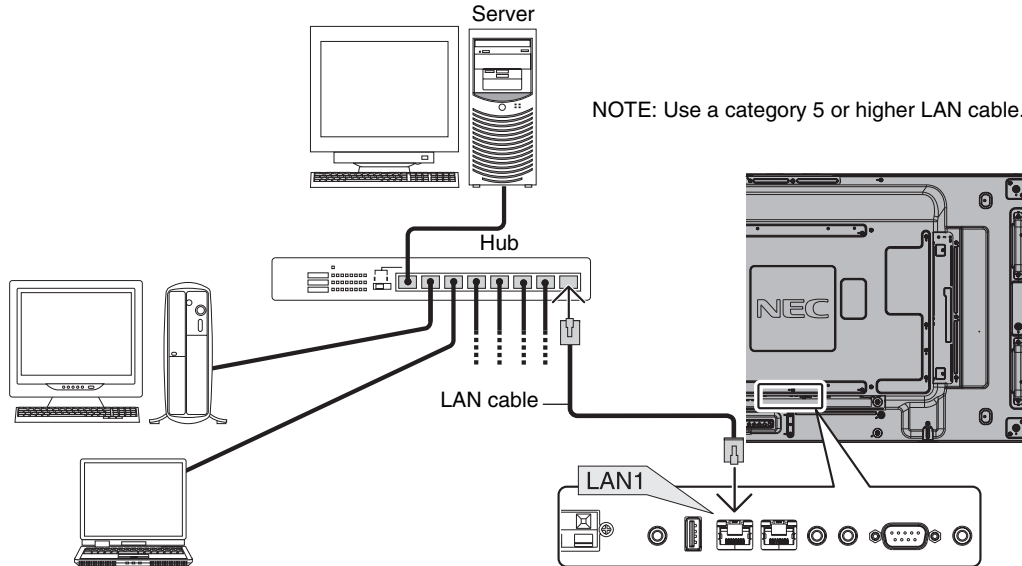

Network Setting by Using an HTTP Browser

Overview

Connecting the monitor to a network allows for monitor control from a computer via the network.

To perform the monitor control from a web browser, you must have an exclusive application installed on your computer.

The IP address and subnet mask of the monitor can be set on the Network Setting screen of the web browser by using an HTTP server function. Please be sure to use "Microsoft Internet Explorer 7.0" or a higher version for the web browser. (This device uses "JavaScript" and "Cookies" and the browser should be set to accept these functions. The setting method will vary depending on the version of browser. Please refer to the help files and the other information provided in your software.)

Access is gained to the HTTP server function by starting the Web browser on the computer via the network connected to the monitor and entering the following URL.

Network Setting

`http://<the Monitor's IP address>/index.html`

TIP: The default IP address is assigned automatically to the monitor.
The exclusive application can be downloaded from our website.

NOTE: If the MONITOR NETWORK SETTINGS screen does not appear in the web browser, press the Ctrl+F5 keys to refresh your web browser (or clear the cache).

The display or button's response can be slowed down or operation may not be accepted depending the settings of your network. Should this happen, consult your network administrator.

The LCD monitor may not respond if its buttons are repeatedly pressed in rapid intervals. Should this happen, wait a moment and repeat. If you still can't get a response, turn the monitor off and then back on.

To control a monitor please use the control command. See "Control command diagram" (page 35).

Preparation Before Use

Connect the monitor to a commercially available LAN cable before engaging in browser operations.

Operation with a browser that uses a proxy server may not be possible depending on the type of proxy server and the setting method. Although the type of proxy server will be a factor, it is possible that items that have actually been set will not be displayed depending on the effectiveness of the cache, and the contents set from the browser may not be reflected in operation. It is recommended that a proxy server not be used unless it is unavailable.

Handling of the Address for Operation via a Browser

The host name can be used under the following cases:

If the host name corresponding to the IP address of the monitor has been registered to the domain name server (DNS) by the network administrator, you can then access the network settings of the display via that registered host name using a compatible browser.

If the host name corresponding to the IP address of the monitor has been configured in the "HOSTS" file of the computer being used, you can then access the network settings of the display via that host name using a compatible browser.

Example 1: When the host name of the monitor has been set to "pd.nec.co.jp", access is gained to the network setting by specifying *http://pd.nec.co.jp/index.html* for the address or the entry column of the URL.

Example 2: When the IP address of the monitor is "192.168.73.1", access is gained to the mail alert settings by specifying *http://192.168.73.1/index.html* for the address or the entry column of the URL.

Operation

Access the following address to show HOME. Click each link on the left side of HOME.

<http://<the Monitor's IP address>/index.html>

REMOTE CONTROL

Enable to control equivalent as the remote control key.

OSD menu

Enable to set the following OSD menu.

PICTURE, ADJUST, AUDIO, SCHEDULE, PIP, OSD, MULTI DISPLAY, DISPLAY PROTECTION, EXTERNAL CONTROL, ADVANCED OPTION1, ADVANCED OPTION2.

NOTE: Function of buttons which are shown on setting pages.

[APPLY]: Reflect your settings.

[CANCEL]: Return to the previous settings. **NOTE:** CANCEL is disabled after clicking APPLY.

[RELOAD]: Reload the settings.

[RESET]: Resets to the initial setting.

Network Setting

Click "NETWORK" on the left side of HOME.

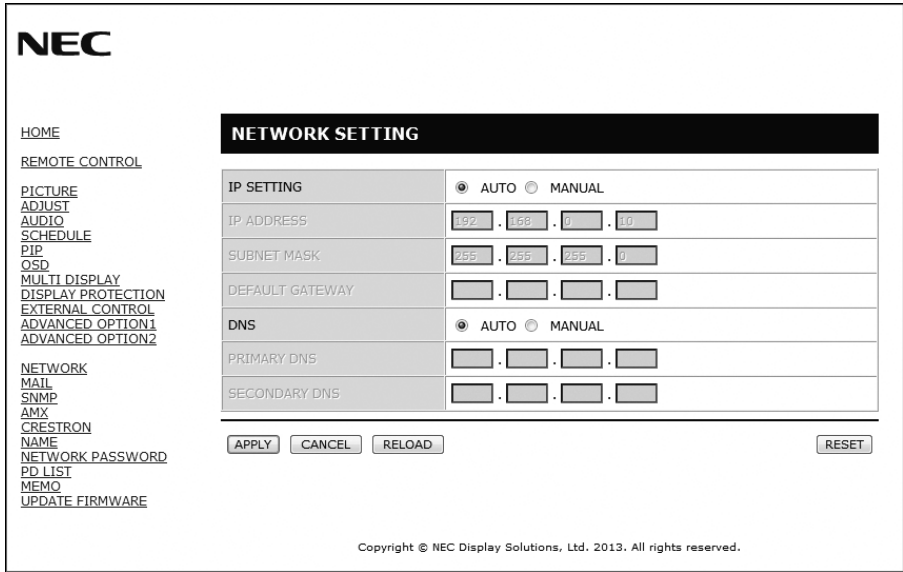

IP SETTING	Set for IP ADDRESS setting. AUTO: Automatically assign an IP address. MANUAL: Set your IP address of the network connected to the monitor. NOTE: Consult your network administrator for the IP address when [AUTO] is selected for [IP SETTING].
IP ADDRESS	Set your IP address of the network connected to the monitor when [MANUAL] is selected for [IP SETTING].
SUBNET MASK	Set your subnet mask number of the network connected to the monitor when [MANUAL] is selected for [IP SETTING].
DEFAULT GATEWAY	Set your default gateway of the network connected to the monitor when [MANUAL] is selected for [IP SETTING]. NOTE: Set as [0.0.0.0] to delete the setting.
DNS	Set for IP ADDRESS setting of DNS server. AUTO: Automatically assign an IP address of DNS server connected to the monitor. MANUAL: Set your IP address of DNS server connected to the monitor.
PRIMARY DNS	Set your primary DNS settings of the network connected to the monitor. NOTE: Set as [0.0.0.0] to delete the setting.
SECONDARY DNS	Set your secondary DNS settings of the network connected to the monitor. NOTE: Set as [0.0.0.0] to delete the setting.

NOTE: The following settings will reset back to the factory setting when "IP ADDRESS RESET" is selected by an EXTERNAL CONTROL of OSD:
 [IP SETTING]: AUTO, [IP ADDRESS]: 192.168.0.10, [SUBNET MASK]: 255.255.255.0, [DNS]: AUTO [DEFAULT GATEWAY], [PRIMARY DNS] and [SECONDARY DNS] are blank.

Mail Setting

Click "MAIL" on the left side of HOME.

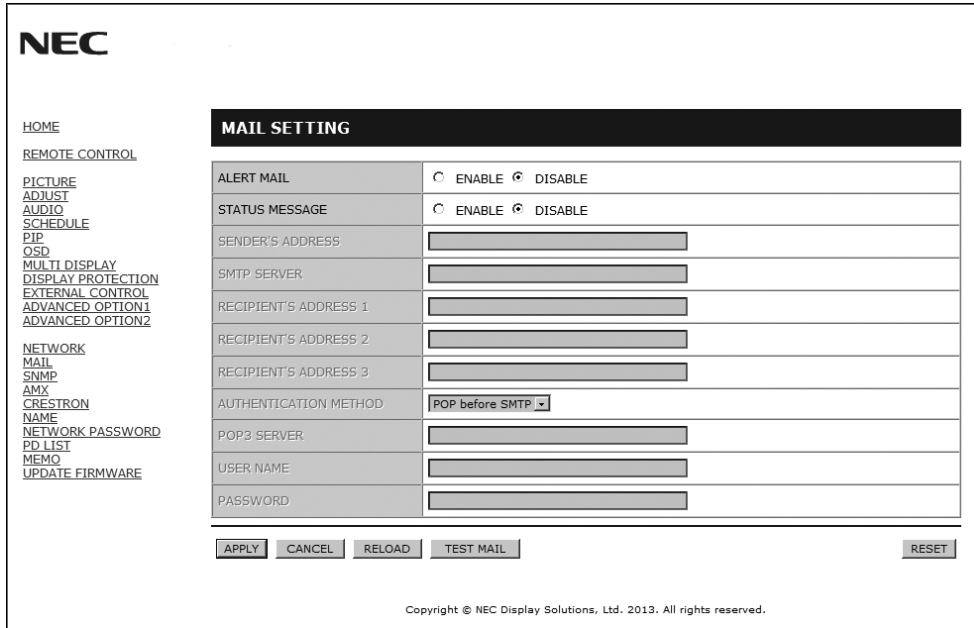

MAIL SETTING	
ALERT MAIL	<input type="radio"/> ENABLE <input checked="" type="radio"/> DISABLE
STATUS MESSAGE	<input type="radio"/> ENABLE <input checked="" type="radio"/> DISABLE
SENDER'S ADDRESS	<input type="text"/>
SMTP SERVER	<input type="text"/>
RECIPIENT'S ADDRESS 1	<input type="text"/>
RECIPIENT'S ADDRESS 2	<input type="text"/>
RECIPIENT'S ADDRESS 3	<input type="text"/>
AUTHENTICATION METHOD	<input type="text" value="POP before SMTP"/>
POP3 SERVER	<input type="text"/>
USER NAME	<input type="text"/>
PASSWORD	<input type="text"/>

Copyright © NEC Display Solutions, Ltd. 2013. All rights reserved.

This option notifies your computer of an error message via e-mail when using wired LAN. An error message notification will be sent when an error occurs in the monitor.

ALERT MAIL	Checking [ENABLE] will turn on the Alert Mail feature. Checking [DISABLE] will turn off the Alert Mail feature.
STATUS MESSAGE	Checking [ENABLE] will turn on the STATUS MESSAGE feature. Checking [DISABLE] will turn off the STATUS MESSAGE feature.
SENDER'S ADDRESS	Type in the senders address. Up to 60 alphanumeric and symbols characters can be used.
SMTP SERVER	Type in the SMTP server name to be connected to the monitor. Up to 60 alphanumeric characters can be used.
RECIPIENT'S ADDRESS 1 TO 3	Type in your recipient's address. Up to 60 alphanumeric and symbols characters can be used.
AUTHENTICATION METHOD	This selects the authentication method of the e-mail transmission.
POP3 SERVER	This specifies the address of the POP3 server that is used in the authentication of the e-mail.
USER NAME	This sets the user name for logging into the authentication server when authentication is required for the e-mail transmission. Up to 60 alphanumeric characters can be used.
PASSWORD	This sets the password for logging into the authentication server when authentication is required for the e-mail transmission. Up to 60 alphanumeric characters can be used.
TEST MAIL	Click this button to send a test mail to check if your settings are correct.

- NOTE:**
- If you execute a test, you may not receive an Alert mail.
Should this happen, check if the network settings are correct.
 - If you entered an incorrect address in a test, you may not receive an Alert mail.
Should this happen, check if the Recipient's Address is correct.

TIP: For Control command diagram, please see file "External_Control.pdf" on the CD-ROM.

Alert error message list

Error number * ErrorCode	Alert mail Message	Explanation	Measure
70h ~ 7Fh	The monitor's power supply is not functioning normally.	Standby power Abnormal	Please contact your supplier.
80h ~ Fh	The cooling fan has stopped.	Cooling fan Abnormal	Please contact your supplier.
90h ~ 9Fh	The monitor's back light unit is not functioning normally.	Backlight abnormal	Please contact your supplier.
A0h ~ AFh	The monitor is overheated.	Temperature Abnormal	Please contact your supplier.
A2h		SENSOR reached at the temperature that the user had specified. *condition: DISPLAY PROTECTION-FAN CONTROL-COOLING FAN = AUTO	Reconfirm the setting condition from OSD (DISPLAY PROTECTION-FAN CONTROL) or please contact your supplier.
B0h ~ BFh	The monitor doesn't have the input signal.	No signal	Please check "No picture" in "Troubleshooting".
D0h	The remaining capacity of the error log decreased.	Proof of Play log memory size is 1 more hour.	Please get a log by using PD external command. See page 45.
E0h ~ EFh	The system error occurred in the monitor.	System error.	Please contact your supplier.

Sample: The following examples are content of Alert Mail that informs the temperature anomaly of monitor.

```

From: nec-tarou@jp.nec.com
To: nec-hanako@jp.nec.com
Subject: [Monitor] Monitor Information

The monitor is overheated.
If this continues please contact NEC for support.
[Code : <ErrorCode>]

[Information]
Product Name : XXXX
Serial Number : 930PT012YA
Hours Running-ON : 108 [H]
Hours Running-Total : 262 [H]
    
```

Sample: The following examples are content of test mail by browser.

```

From: nec-tarou@jp.nec.com
To: nec-hanako@jp.nec.com
Subject: [Monitor] Test Mail

Alert Mail configurations are as follows:

Product Name : XXXX
Serial Number : 930PT012YA
Sender's Address : nec-tarou@jp.nec.com
SMTP Server Name : mail.nec.jp.com
Recipient's Address 1 : nec-hanako@jp.nec.com
Recipient's Address 2 :
Recipient's Address 3 :
    
```

SNMP Setting

Click "SNMP" on the left side of HOME.

The screenshot shows the 'SNMP SETTING' screen. On the left is a sidebar menu with options: HOME, REMOTE CONTROL, PICTURE, ADJUST, AUDIO, SCHEDULE, PIP, OSD, MULTI DISPLAY, DISPLAY PROTECTION, EXTERNAL CONTROL, ADVANCED OPTION1, ADVANCED OPTION2, NETWORK, MAIL, SNMP, AMX, CRESTRON, NAME, NETWORK PASSWORD, PD LIST, MEMO, and UPDATE FIRMWARE. The main content area has a title bar 'SNMP SETTING' and the following settings:

- SNMP:** ENABLE DISABLE
- SNMP VERSION:** SNMPv2c
- COMMUNITY NAME 1:** public, READ ONLY READ/WRITE
- COMMUNITY NAME 2:** private, READ ONLY READ/WRITE
- COMMUNITY NAME 3:** (empty), READ ONLY READ/WRITE
- TRAP:** ENABLE DISABLE
- TRAP ADDRESS:**
- TRAP OPTION:**
 - TEMPERATURE
 - FAN
 - POWER
 - INVERTER/BACKLIGHT
 - NO SIGNAL
 - PROOF OF PLAY
 - SYSTEM ERROR

Buttons at the bottom: APPLY, CANCEL, RELOAD, RESET. Copyright © NEC Display Solutions, Ltd. 2013. All rights reserved.

This function allows for getting status and controlling of a monitor via the network.

Version:

SNMP v1 Authenticated plaintext by community name, not return a confirmation message of Trap.

SNMP v2c Authenticated plaintext by community name, return a confirmation message of Trap.

Community name:

The default setting of community name is "public". It is read only. You can set community names for up to 3 settings.

Trap:

Sending error message to specified address when an error occurs in the monitor.

Check Box	Explanation	Error code
Temperature	Temperature abnormal	0xA0, 0xA1, 0xA2
Fan	Cooling fan abnormal	0x80, 0x81
Power	Power abnormal	0x70, 0x71, 0x72, 0x78
Inverter/Backlight	Inverter or backlight abnormal	0x90, 0x91
No Signal	No signal	0xB0
PROOF OF PLAY	Lower the log storage	0xD0
System Error	System error	0xE0

AMX Setting

Click "AMX" on the left side of HOME.

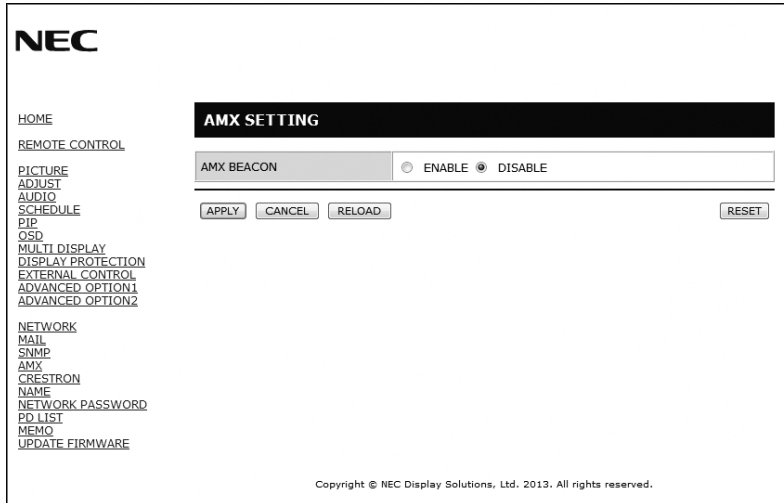

<p>AMX BEACON</p>	<p>Turn on or off for detection from AMX Device Discovery when connecting to the network supported by AMX's NetLinx control system.</p> <p><i>TIP:</i> When using a device that supports AMX Device Discovery, all AMX NetLinx control system will recognize the device and download the appropriate Device Discovery Module from an AMX server. Checking [ENABLE] will detect the device from AMX Device Discovery. Checking [DISABLE] will not detect the device from AMX Device Discovery.</p>
-------------------	--

CRESTRON Setting

Click "CRESTRON" on the left side of HOME.

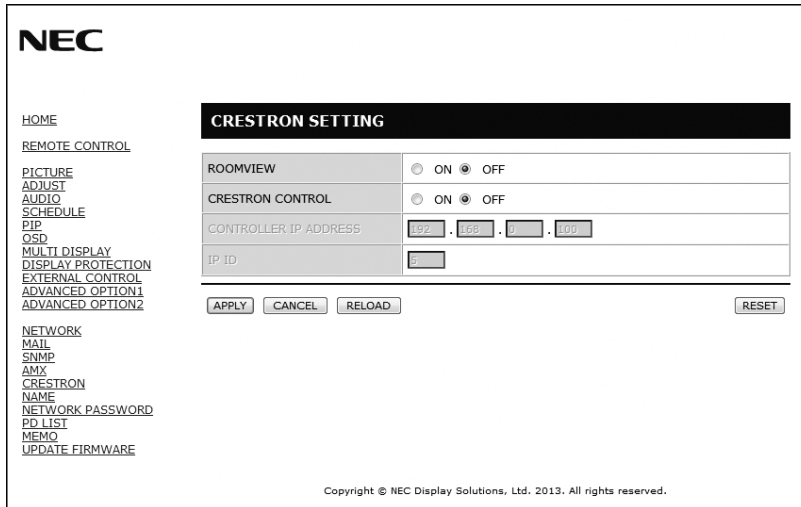

CRESTRON ROOMVIEW compatibility

The monitor supports CRESTRON ROOMVIEW, allowing multiple devices connected in the network to be managed and controlled from a computer or a controller.

For more information, visit <http://www.crestron.com>

<p>ROOMVIEW</p>	<p>ROOMVIEW for managing from the computer. ON: Enables ROOMVIEW. OFF: Disables ROOMVIEW.</p>
<p>CRESTRON CONTROL</p>	<p>CRESTRON CONTROL for managing from the controller. ON: Enables CRESTRON CONTROL. OFF: Disables CRESTRON CONTROL.</p>
<p>CONTROLLER IP ADDRESS</p>	<p>Set your IP address of CRESTRON SERVER.</p>
<p>IP ID</p>	<p>Set your IP ID of CRESTRON SERVER.</p>

TIP: The CRESTRON settings are required only for use with CRESTRON ROOMVIEW. For more information, visit <http://www.crestron.com>

Name Setting

Click "NAME" on the left side of HOME.

The screenshot shows the NEC Name Setting interface. On the left, a vertical menu lists various settings, with 'NAME' selected. The main content area is titled 'NAME SETTING' and features three input fields for 'MONITOR NAME', 'HOST NAME', and 'DOMAIN NAME'. At the bottom of this section are 'APPLY', 'CANCEL', and 'RESET' buttons. The footer contains the copyright notice: 'Copyright © NEC Display Solutions, Ltd. 2013. All rights reserved.'

MONITOR NAME	Set a monitor name. The name must be 16 characters or less. The default is model name.
HOST NAME	Type in the hostname of the network connected to the monitor. Up to 15 alphanumeric characters can be used.
DOMAIN NAME	Type in the domain name of the network connected to the monitor. Up to 60 alphanumeric characters can be used.

Network Password Setting

Click "NETWORK PASSWORD" on the left side of HOME.

The screenshot shows the NEC Network Password Setting interface. On the left, a vertical menu lists various settings, with 'NETWORK PASSWORD' selected. The main content area is titled 'NETWORK PASSWORD SETTING' and features three sections: 'PJLink PASSWORD' with an 'ENTER PASSWORD' button, 'HTTP PASSWORD' with a 'CHANGE PASSWORD' button, and 'HTTP PASSWORD ENABLE' with a checkbox. At the bottom of this section are 'APPLY', 'CANCEL', and 'RESET' buttons. The footer contains the copyright notice: 'Copyright © NEC Display Solutions, Ltd. 2013. All rights reserved.'

PJLink PASSWORD	Set a password for PJLink*. A password must be 32 characters or less. Do not forget your password. However, if you forget your password, consult with your dealer.
HTTP PASSWORD	Set a password for HTTP server. A password must be 10 characters or less.
HTTP PASSWORD ENABLE	HTTP PASSWORD is required when logging in HTTP server. Set a monitor name as USER NAME when inputting the password.

*What is PJLink?

PJLink is a standardization of protocol used for controlling devices of different manufacturers. This standard protocol is established by Japan Business Machine and Information System Industries Association (JBMA) in 2005. The device supports all the commands of PJLink Class 1.

PD List Information

Click "PD LIST" on the left side of HOME.

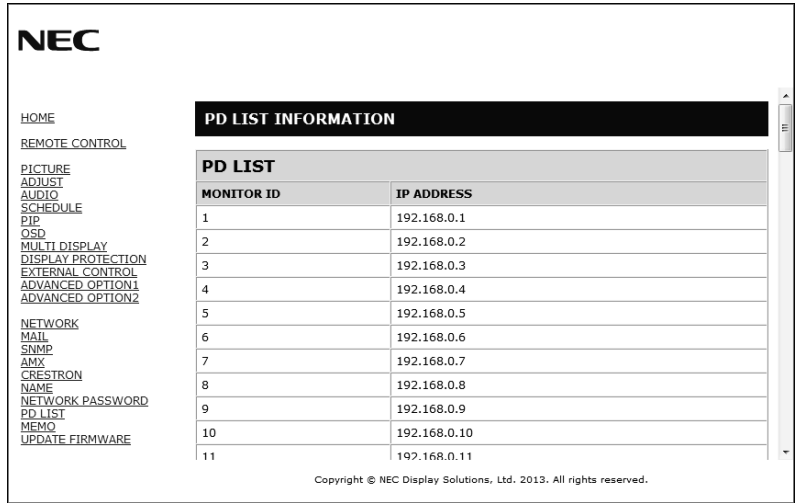

Show the list of ID and IP address of multiple monitors that are daisy-chained. Only the master monitor can show the list.

Memo Setting

Click "MEMO" on the left side of HOME.

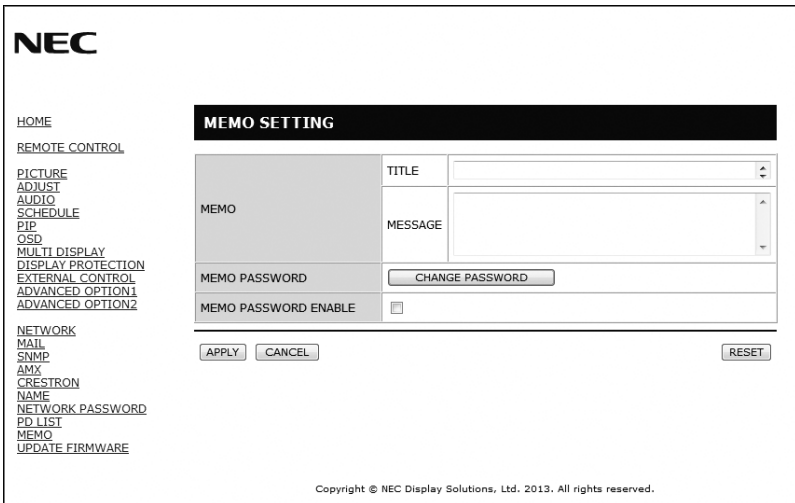

Set a title and message.

TITLE	A title must be 24 characters or less.
MESSAGE	A message must be 240 characters or less.
MEMO PASSWORD	The default is "0000".
MEMO PASSWORD ENABLE	MEMO PASSWORD is required when setting MEMO.

POINT ZOOM



Using “SET/POINT ZOOM” button on a remote control allows to enlarge a partial of image. Press CH+/- button to zoom up or down. The image can be expanded from 1 to 10 times.

- 1 Press [SET/POINT ZOOM] button on a remote control. An icon will be a magnifier.
- 2 Move magnifier icon by [▲] [▼] [+] [-] button.
- 3 Press [CH+] to zoom up. Press [CH-] to zoom down.
- 4 Press [SET/POINT ZOOM] to disappear the icon.
- 5 Press [EXIT] to return to a normal size.
- 6 Press [MENU] to display OSD menu.<Setting Procedure>

- NOTE:**
- The image may be distorted during this function.
 - This function does not work when set to PIP, POP, PBP, TILE MATRIX, SCREEN SAVER, SUPER in INPUT CHANGE, IMAGE FLIP.
 - When selected DYNAMIC or ZOOM in ASPECT, the image will be changed FULL, then start to POINT ZOOM. After POINT ZOOM, the ASPECT will be returned previous ASPECT settings. When the ASPECT is changed during POINT ZOOM, DYNAMIC and ZOOM will be FULL image.
 - The magnifier icon does not move to no image area.
 - POINT ZOOM will be released after changing input signal or power off.
 - POINT ZOOM will be released when setting IMAGE FLIP or changing ASPECT setting during POINT ZOOM.

PROOF OF PLAY

This function allows to send message for the current status of monitor by self checking.

Check item		Message
①	INPUT	DVI, VGA, Y/Pb/Pr, HDMI, DPORT, HDMI2*, HDMI3*, RGB/HV*, Y/Pb/Pr2*, SCART*, VIDEO*, S-VIDEO*, OPTION*
②	Resolution	ex. (H)1920, (V)1080 , (H)1360, (V)768 or No signal or Invalid signal
③	Audio INPUT	IN1, IN2, IN3*, HDMI, DPORT, HDMI2*, HDMI3*, OPTION (analog)*, OPTION (digital)*
④	Audio signal	Audio in or No Audio in or N/A (IN1, IN2, IN3*, OPTION (analog)*)
⑤	Picture Image	Normal Picture or No Picture
⑥	Audio out	Normal Audio or No Audio
⑦	Cumulative time	(hour)/(minutes)/(second)

*: This function depends on which option board you use.

Sample:

- ① HDMI
- ② 1920 x 1080
- ③ HDMI
- ④ Audio in
- ⑤ Normal Picture
- ⑥ Normal Audio
- ⑦ 0h/0m/0s

NOTE: For Proof of Play function, please see “External_Control.pdf” on the CD-ROM.

INTELLIGENT WIRELESS DATA

This function allows to get the data of monitor's status by wireless communication even while the monitor is off. Some menu of OSD, you can set by this function.

NOTE: Sensor position: see page 9.
Please contact your supplier for detailed information.

Function name
Setting Copy
Setting read and write function
Display information
Security Setting

Features

Ultra Narrow Bezel: Provides the optimum solution in a tiling environment.

Reduced Footprint: Provides the ideal solution for environments with superior image quality.

Color Control Systems: Allow you to adjust the colors on your screen and customize the color accuracy of your monitor to a variety of standards.

OmniColor: Combines Six-axis color control and the sRGB standard. Six-axis color control permits color adjustments via six axes (R, G, B, C, M and Y) rather than through the three axes (R, G and B) previously available. The sRGB standard provides the monitor with a uniform color profile. This assures that the colors displayed on the monitor are exactly the same as on the color printout (with sRGB supporting operating system and sRGB printer). This allows you to adjust the colors on your screen and customise the color accuracy of your monitor to a variety of standards.

sRGB Color Control: A new optimized color management standard which allows for color matching on computer displays and other peripherals. The sRGB standard, which is based on a calibrated color space, allows for optimal color representation and backward compatibility with other common color standards.

OSD (On-Screen-Display) Controls: Allow you to quickly and easily adjust all elements of your screen image via simple to use on-screen menus.

Plug and Play: The Microsoft® solution with the Windows® operating system facilitates setup and installation by allowing the monitor to send its capabilities (such as screen size and resolutions supported) directly to your computer, automatically optimizing display performance.

IPM (Intelligent Power Manager) System: Provides innovative power-saving methods that allow the monitor to shift to a lower power consumption level when on but not in use, saving two-thirds of your monitor energy costs, reducing emissions and lowering the air conditioning costs of the workplace.

FullScan Capability: Allows you to use the entire screen area in most resolutions, significantly expanding image size.

VESA Standard (FDMIv1) Mounting Interface: Allows you to connect your LCD monitor to any VESA standard (FDMIv1) third party mounting arm or bracket. NEC recommends using mounting interface that comply with TÜV-GS and/or UL1678 standard in North America.

DVI-D: The digital-only subset of DVI ratified by the Digital Display Working Group (DDWG) for digital connections between computers and displays. As a digital-only connector, analog support is not provided for a DVI-D connector. As a DVI-based digital only connection, only a simple adapter is necessary for compatibility between DVI-D and other DVI-based digital connectors such as DFP and P&D. The DVI interface of this display supports HDCP.

TILE MATRIX, TILE COMP: Shows one image over multiple screens with accuracy while compensating for bezel width.

ZOOM: Expands/reduces image size for horizontal and vertical direction.

Self-diagnosis: If an internal error should occur, a failure state will be indicated.

HDCP (High-bandwidth Digital Content Protection): HDCP is a system for preventing illegal copying of video data sent over a digital signal. If you are unable to view material via the digital input, this does not necessarily mean the display is not functioning properly. With the implementation of HDCP, there may be cases in which certain content is protected with HDCP and might not be displayed due to the decision/intention of the HDCP community (Digital Content Protection, LLC).

Option board slot: You can use an option board. Please contact your supplier for detailed information.

Troubleshooting

No picture

- The signal cable should be completely connected to the display card/computer.
- The display card should be completely seated in its slot.
- Check the main Power Switch, it should be in the ON position.
- Power Switch and computer power switch should be in the ON position.
- Check to make sure that a supported mode has been selected on the display card or system being used. (Please consult display card or system manual to change graphics mode.)
- Check the monitor and your display card with respect to compatibility and recommended settings.
- Check the signal cable connector for bent or pushed-in pins.
- The monitor automatically goes into OFF at the preset time period after signal is lost. Press the power button.
- Check the DVI MODE setting when DVD player or computer equipment is connected to the DVI input.

Power Button does not respond

- Unplug the power cord of the monitor from the AC outlet to turn off and reset the monitor.
- Check the main Power Switch on the back side of the monitor.

Snowy Picture, Black Screen in DVI input

- Check the DVI MODE setting when DVD player or computer equipment is connected to the DVI input.

Image persistence

- Please be aware that LCD Technology may experience a phenomenon known as Image Persistence. Image Persistence occurs when a residual or “ghost” image of a previous image remains visible on the screen. Unlike CRT monitors, LCD monitors’ image persistence is not permanent, but constant images being displayed for a long period of time should be avoided. To alleviate image persistence, turn off the monitor for as long as the previous image was displayed. For example, if an image was on the monitor for one hour and a residual image remains, the monitor should be turned off for one hour to erase the image.

NOTE: As with all personal display devices, NEC DISPLAY SOLUTIONS recommends displaying moving images and using a moving screen saver at regular intervals whenever the screen is idle or turning off the monitor when not in use.

Image is unstable, unfocused or swimming is apparent

- Signal cable should be completely attached to the computer.
- Use the OSD Image Adjust controls to focus and adjust display by increasing or decreasing the fine adjustment. When the display mode is changed, the OSD Image Adjust settings may need to be re-adjusted.
- Check the monitor and your display card with respect to compatibility and recommended signal timings.
- If your text is garbled, change the video mode to non-interlace and use 60Hz refresh rate.
- The image may be distorted when turning the power on or changing the settings.

Image of component signal is greenish

- Check to see if the Y/Pb/Pr input connector is selected.

LED on monitor is not lit (no green or red color can be seen)

- Power Switch should be in the ON position and power cord should be connected.
- Check the main Power Switch, it should be in the ON position.
- Make certain the computer is not in a power-saving mode (touch the keyboard or mouse).
- Check to see that the power indicator option in the OSD is set to ON.

RED LED on monitor is blinking

- A certain failure might have occurred, please contact your nearest authorized NEC DISPLAY SOLUTIONS service facility.
- If the monitor is powered off by the inside temperature being higher than the normal operating temperature, a RED LED will blink six times. Power on the display again after confirming the inside temperature has been reduced to normal operation temperature.

Display image is not sized properly

- Use the OSD Image Adjust controls to increase or decrease the coarse adjustment.
- Check to make sure that a supported mode has been selected on the display card or system being used. (Please consult display card or system manual to change graphics mode.)

Selected resolution is not displayed properly

- Use OSD Display Mode to enter Information menu and confirm that the appropriate resolution has been selected. If not, select corresponding option.

No Sound

- Check to see if audio cable is properly connected.
- Check to see if mute is activated.
- Check to see if volume is set at minimum.
- Check to see if computer supports an audio signal through DisplayPort. If unsure, contact the computer manufacturer.
- Check to see if SURROUND is ON.

Remote Control is not available

- Check the Remote Control’s batteries status.
- Check if batteries are inserted correctly.
- Check if the Remote Control is pointing at the monitor’s remote sensor.
- Check the IR LOCK SETTING status.
- The remote control system may not function when direct sunlight or strong illumination strikes the remote control sensor of the LCD monitor, or when there is an object in the path.

“SCHEDULE”/“OFF TIMER” function is not working properly

- The “SCHEDULE” function will be disabled when the “OFF TIMER” is set.
- If the “OFF TIMER” function is enabled and the power to the LCD monitor is turned off when the power supply is interrupted unexpectedly, then the “OFF TIMER” will be reset.

Snowy Picture, Poor Sound in TV

- Check antenna/cable connection. Use new cable if necessary.

Interference in TV

- Check components for shielding, move away from monitor if necessary.

RS-232C or LAN control is not available

- Check RS-232C or LAN cable connection.

Either light vertical or horizontal stripes may appear, depending on the specific display pattern. This is no product fault or degradation.

Specifications - X555UNS

Product Specifications

LCD Module		Pixel Pitch: Resolution: Color: Brightness: Contrast Ratio: Viewing Angle:	55"/1388 mm diagonal 0.630 mm 1920 x 1080 Over 1073 million colors (depending on display card used) 700 cd/m ² (Max.) @25°C 1200:1 89° (typ) @ CR>10
Frequency		Horizontal: Vertical:	15.625/15.734 kHz, 31.5 kHz - 91.1 kHz 50.0 - 85.0 Hz (Analog Input) 24.0 - 85.0 Hz (Digital Input)
Pixel Clock			Analog: 13.5 MHz, 25.0 MHz - 195.0 MHz Digital: 25.0 MHz - 165.0 MHz (DVI), 25.0 MHz - 300.0 MHz (HDMI/DisplayPort)
Viewable Size			1209.6 x 680.4 mm
Input Signal			
DVI	DVI-D 24pin	Digital RGB	DVI (HDCP) VGA60, SVGA60, XGA60, WXGA60, SXGA60, UXGA60* ¹ , 1920X1080 (60Hz), 1080p, 1080i
DisplayPort	DisplayPort Connector	Digital RGB	DisplayPort Complies with Standard V1.2, applicable to HDCP V1.3 VGA60, SVGA60, XGA60, WXGA60, SXGA60, UXGA60* ¹ , WUXGA60* ¹ , 1920x1080 (60 Hz), 1080p, 1080i, 720p@50Hz/60Hz, 576p@50Hz, 480p@60Hz, 3840x2160 (30Hz/24Hz)* ¹ ,* ⁴
VGA* ²	15pin Mini D-sub	Analog RGB	0.7 Vp-p/75 ohm VGA60, SVGA60, XGA60, WXGA60, SXGA60, UXGA60* ¹ , WUXGA60* ¹ , 1920X1080 (60Hz)
		Sync	Separate: TTL level (Pos./Neg.) Composite sync on Green Video: 0.3 Vp-p Neg.
HDMI	HDMI Connector	Digital YUV Digital RGB	HDMI VGA60, SVGA60, XGA60, WXGA60, SXGA60, UXGA60* ¹ , WUXGA60* ¹ , 1920x1080 (60 Hz), 1080p, 1080i, 720p@50Hz/60Hz, 576p@50Hz, 480p@60Hz, 576i@50Hz, 480i@60Hz, 3840x2160 (30Hz/24Hz/25Hz)* ¹ ,* ⁴ , 4096x2160 (24Hz)* ¹ ,* ⁴
Y/Pb/Pr* ²	15pin Mini D-sub	Component	Y: 1.0 Vp-p/75ohm, Cb/Cr (Pb/Pr): 0.7 Vp-p/75 ohm HDTV/DVD: 1080p, 1080i, 720p@50Hz/60Hz, 576p@50Hz, 480p@60Hz, 576i@50Hz, 480i@60Hz
Output Signal			
DisplayPort	DisplayPort Connector	Digital RGB	DisplayPort Complies with Standard V1.2, applicable to HDCP V1.3
AUDIO			
AUDIO Input	STEREO Mini Jack	Analog Audio	Stereo L/R 0.5 Vrms
	HDMI Connector	Digital Audio	PCM 32, 44.1, 48 KHz (16/20/24bit)
	DisplayPort Connector	Digital Audio	PCM 32, 44.1, 48 KHz (16/20/24bit)
AUDIO Output	STEREO Mini Jack	Analog Audio	Stereo L/R 0.5 Vrms
Speaker Output			External Speaker Jack 15 W + 15 W (8 ohm)
Control		RS-232C In: LAN: Remote IN:	9 Pin D-sub RJ-45 10/100 BASE-T Stereo Mini jack 3.5 Φ
Service port			USB service port for maintenance
Power Supply			4.4 - 1.6 A @ 100-240V AC, 50/60Hz
Operational Environment		Temperature* ³ : Humidity: Altitude:	0 - 40°C / 32 - 104°F 20 - 80% (without condensation) 0 - 3000 m (Brightness may decrease with altitude)
Storage Environment		Temperature: Humidity:	-20 - 60°C / -4 - 140°F 10 - 90% (without condensation) / 90% - 3.5% x (Temp - 40°C) regarding over 40°C
Dimension			1213.4 (W) x 684.2 (H) x 95.3 (D) mm / 47.8 (W) x 26.9 (H) x 3.8 (D) inches
Weight			29.5 kg (65.0 lbs)
VESA compatible mounting interface			400 mm x 400 mm (M6, 4 Holes)
Power Management			VESA DPM
Plug & Play			VESA DDC2Bi, DDC/CI, DisplayPort
Power supply for Slot 2 type OPTION			16V/3.6 A
Accessories			Setup manual, Power Cord, Video Signal cable (DisplayPort to DisplayPort cable), LAN cable, Clamp x 3, Screw x 3, CD-ROM, Thumbscrew for optional stand x 2

NOTE: Technical specifications are subject to change without notice.

*1: Compressed image.

*2: Common terminal.

*3: When you use option board accessories, please contact your supplier for detailed information.

*4: Displayed text may be blurred.

Specifications - X555UNV

Product Specifications

LCD Module		Pixel Pitch: 0.630 mm Resolution: 1920 x 1080 Color: Over 1073 million colors (depending on display card used) Brightness: 500 cd/m ² (Max.) @25°C Contrast Ratio: 1200:1 Viewing Angle: 89° (typ) @ CR>10	55"/1388 mm diagonal
Frequency		Horizontal: 15.625/15.734 kHz, 31.5 kHz - 91.1 kHz Vertical: 50.0 - 85.0 Hz (Analog Input) 24.0 - 85.0 Hz (Digital Input)	
Pixel Clock		Analog: 13.5 MHz, 25.0 MHz - 195.0 MHz Digital: 25.0 MHz - 165.0 MHz (DVI), 25.0 MHz - 300.0 MHz (HDMI/DisplayPort)	
Viewable Size		1209.6 x 680.4 mm	
Input Signal			
DVI	DVI-D 24pin	Digital RGB	DVI (HDCP) VGA60, SVGA60, XGA60, WXGA60, SXGA60, UXGA60* ¹ , 1920X1080 (60Hz), 1080p, 1080i
DisplayPort	DisplayPort Connector	Digital RGB	DisplayPort Complies with Standard V1.2, applicable to HDCP V1.3 VGA60, SVGA60, XGA60, WXGA60, SXGA60, UXGA60* ¹ , WUXGA60* ¹ , 1920x1080 (60 Hz), 1080p, 1080i, 720p@50Hz/60Hz, 576p@50Hz, 480p@60Hz, 3840x2160 (30Hz/24Hz)* ¹ ,* ⁴
VGA* ²	15pin Mini D-sub	Analog RGB	0.7 Vp-p/75 ohm VGA60, SVGA60, XGA60, WXGA60, SXGA60, UXGA60* ¹ , WUXGA60* ¹ , 1920X1080 (60Hz)
		Sync	Separate: TTL level (Pos./Neg.) Composite sync on Green Video: 0.3 Vp-p Neg.
HDMI	HDMI Connector	Digital YUV Digital RGB	HDMI VGA60, SVGA60, XGA60, WXGA60, SXGA60, UXGA60* ¹ , WUXGA60* ¹ , 1920x1080 (60 Hz), 1080p, 1080i, 720p@50Hz/60Hz, 576p@50Hz, 480p@60Hz, 576i@50Hz, 480i@60Hz, 3840x2160 (30Hz/24Hz/25Hz)* ¹ ,* ⁴ , 4096x2160 (24Hz)* ¹ ,* ⁴
Y/Pb/Pr* ²	15pin Mini D-sub	Component	Y: 1.0 Vp-p/75ohm, Cb/Cr (Pb/Pr): 0.7 Vp-p/75 ohm HDTV/DVD: 1080p, 1080i, 720p@50Hz/60Hz, 576p@50Hz, 480p@60Hz, 576i@50Hz, 480i@60Hz
Output Signal			
DisplayPort	DisplayPort Connector	Digital RGB	DisplayPort Complies with Standard V1.2, applicable to HDCP V1.3
AUDIO			
AUDIO Input	STEREO Mini Jack	Analog Audio	Stereo L/R 0.5 Vrms
	HDMI Connector	Digital Audio	PCM 32, 44.1, 48 KHz (16/20/24bit)
	DisplayPort Connector	Digital Audio	PCM 32, 44.1, 48 KHz (16/20/24bit)
AUDIO Output	STEREO Mini Jack	Analog Audio	Stereo L/R 0.5 Vrms
Speaker Output		External Speaker Jack 15 W + 15 W (8 ohm)	
Control		RS-232C In: 9 Pin D-sub LAN: RJ-45 10/100 BASE-T Remote IN: Stereo Mini jack 3.5 Φ	
Service port		USB service port for maintenance	
Power Supply		3.4 - 1.2 A @ 100-240V AC, 50/60Hz	
Operational Environment		Temperature* ³ : 0 - 40°C / 32 - 104°F Humidity: 20 - 80% (without condensation) Altitude: 0 - 3000 m (Brightness may decrease with altitude)	
Storage Environment		Temperature: -20 - 60°C / -4 - 140°F Humidity: 10 - 90% (without condensation) / 90% - 3.5% x (Temp - 40°C) regarding over 40°C	
Dimension		1213.4 (W) x 684.2 (H) x 95.3 (D) mm / 47.8 (W) x 26.9 (H) x 3.8 (D) inches	
Weight		29.5 kg (65.0 lbs)	
VESA compatible mounting interface		400 mm x 400 mm (M6, 4 Holes)	
Power Management		VESA DPM	
Plug & Play		VESA DDC2Bi, DDC/CI, DisplayPort	
Power supply for Slot 2 type OPTION		16V/3.6 A	
Accessories		Setup manual, Power Cord, Video Signal cable (DisplayPort to DisplayPort cable), LAN cable, Clamp x 3, Screw x 3, CD-ROM, Thumbscrew for optional stand x 2	

NOTE: Technical specifications are subject to change without notice.

*1: Compressed image.

*2: Common terminal.

*3: When you use option board accessories, please contact your supplier for detailed information.

*4: Displayed text may be blurred.

Specifications - UN551S

Product Specifications

LCD Module		Pixel Pitch: 0.630 mm Resolution: 1920 x 1080 Color: Over 1073 million colors (depending on display card used) Brightness: 700 cd/m ² (Max.) @25°C Contrast Ratio: 1200:1 Viewing Angle: 89° (typ) @ CR>10	55"/1388 mm diagonal
Frequency		Horizontal: 15.625/15.734 kHz, 31.5 kHz - 91.1 kHz Vertical: 50.0 - 85.0 Hz (Analog Input) 24.0 - 85.0 Hz (Digital Input)	
Pixel Clock		Analog: 13.5 MHz, 25.0 MHz - 195.0 MHz Digital: 25.0 MHz - 165.0 MHz (DVI), 25.0 MHz - 300.0 MHz (HDMI/DisplayPort)	
Viewable Size		1209.6 x 680.4 mm	
Input Signal			
DVI	DVI-D 24pin	Digital RGB	DVI (HDCP) VGA60, SVGA60, XGA60, WXGA60, SXGA60, UXGA60* ¹ , 1920X1080 (60Hz), 1080p, 1080i
DisplayPort	DisplayPort Connector	Digital RGB	DisplayPort Complies with Standard V1.2, applicable to HDCP V1.3 VGA60, SVGA60, XGA60, WXGA60, SXGA60, UXGA60* ¹ , WUXGA60* ¹ , 1920x1080 (60 Hz), 1080p, 1080i, 720p@50Hz/60Hz, 576p@50Hz, 480p@60Hz, 3840x2160 (30Hz/24Hz)* ¹ ,* ⁴
VGA* ²	15pin Mini D-sub	Analog RGB	0.7 Vp-p/75 ohm VGA60, SVGA60, XGA60, WXGA60, SXGA60, UXGA60* ¹ , WUXGA60* ¹ , 1920X1080 (60Hz)
		Sync	Separate: TTL level (Pos./Neg.) Composite sync on Green Video: 0.3 Vp-p Neg.
HDMI	HDMI Connector	Digital YUV Digital RGB	HDMI VGA60, SVGA60, XGA60, WXGA60, SXGA60, UXGA60* ¹ , WUXGA60* ¹ , 1920x1080 (60 Hz), 1080p, 1080i, 720p@50Hz/60Hz, 576p@50Hz, 480p@60Hz, 576i@50Hz, 480i@60Hz, 3840x2160 (30Hz/24Hz/25Hz)* ¹ ,* ⁴ , 4096x2160 (24Hz)* ¹ ,* ⁴
Y/Pb/Pr* ²	15pin Mini D-sub	Component	Y: 1.0 Vp-p/75ohm, Cb/Cr (Pb/Pr): 0.7 Vp-p/75 ohm HDTV/DVD: 1080p, 1080i, 720p@50Hz/60Hz, 576p@50Hz, 480p@60Hz, 576i@50Hz, 480i@60Hz
Output Signal			
DisplayPort	DisplayPort Connector	Digital RGB	DisplayPort Complies with Standard V1.2, applicable to HDCP V1.3
AUDIO			
AUDIO Input	STEREO Mini Jack	Analog Audio	Stereo L/R 0.5 Vrms
	HDMI Connector	Digital Audio	PCM 32, 44.1, 48 KHz (16/20/24bit)
	DisplayPort Connector	Digital Audio	PCM 32, 44.1, 48 KHz (16/20/24bit)
AUDIO Output	STEREO Mini Jack	Analog Audio	Stereo L/R 0.5 Vrms
Speaker Output		External Speaker Jack 15 W + 15 W (8 ohm)	
Control		RS-232C In: 9 Pin D-sub LAN: RJ-45 10/100 BASE-T Remote IN: Stereo Mini jack 3.5 Φ	
Service port		USB service port for maintenance	
Power Supply		4.4 - 1.6 A @ 100-240V AC, 50/60Hz	
Operational Environment		Temperature* ³ : 0 - 40°C / 32 - 104°F Humidity: 20 - 80% (without condensation) Altitude: 0 - 3000 m (Brightness may decrease with altitude)	
Storage Environment		Temperature: -20 - 60°C / -4 - 140°F Humidity: 10 - 90% (without condensation) / 90% - 3.5% x (Temp - 40°C) regarding over 40°C	
Dimension (without SIDE SEAL)		1211.4 (W) x 682.2 (H) x 98.8 (D) mm / 47.7 (W) x 26.9 (H) x 3.9 (D) inches (without handle) 1211.4 (W) x 682.2 (H) x 101.9 (D) mm / 47.7 (W) x 26.9 (H) x 4.0 (D) inches (with handle)	
Weight		26.0 kg (57.3 lbs)	
VESA compatible mounting interface		400 mm x 400 mm (M6, 4 Holes)	
Power Management		VESA DPM	
Plug & Play		VESA DDC2Bi, DDC/CI, DisplayPort	
Power supply for Slot 2 type OPTION		16V/3.6 A	
Accessories		Setup manual, Power Cord, Video Signal cable (DisplayPort to DisplayPort cable), LAN cable, Clamp x 3, Screw (M4) x 3, Screw (M3) x 1, Spacer x 4, Pin x 4, CD-ROM, Thumbscrew for optional stand x 2	

NOTE: Technical specifications are subject to change without notice.

*1: Compressed image.

*2: Common terminal.

*3: When you use option board accessories, please contact your supplier for detailed information.

*4: Displayed text may be blurred.

Specifications - UN551VS

Product Specifications

LCD Module		Pixel Pitch: Resolution: Color: Brightness: Contrast Ratio: Viewing Angle:	55"/1388 mm diagonal 0.630 mm 1920 x 1080 Over 1073 million colors (depending on display card used) 500 cd/m ² (Max.) @25°C 1200:1 89° (typ) @ CR>10
Frequency		Horizontal: Vertical:	15.625/15.734 kHz, 31.5 kHz - 91.1 kHz 50.0 - 85.0 Hz (Analog Input) 24.0 - 85.0 Hz (Digital Input)
Pixel Clock			Analog: 13.5 MHz, 25.0 MHz - 195.0 MHz Digital: 25.0 MHz - 165.0 MHz (DVI), 25.0 MHz - 300.0 MHz (HDMI/DisplayPort)
Viewable Size			1209.6 x 680.4 mm
Input Signal			
DVI	DVI-D 24pin	Digital RGB	DVI (HDCP) VGA60, SVGA60, XGA60, WXGA60, SXGA60, UXGA60* ¹ , 1920X1080 (60Hz), 1080p, 1080i
DisplayPort	DisplayPort Connector	Digital RGB	DisplayPort Complies with Standard V1.2, applicable to HDCP V1.3 VGA60, SVGA60, XGA60, WXGA60, SXGA60, UXGA60* ¹ , WUXGA60* ¹ , 1920x1080 (60 Hz), 1080p, 1080i, 720p@50Hz/60Hz, 576p@50Hz, 480p@60Hz, 3840x2160 (30Hz/24Hz)* ¹ ,* ⁴
VGA* ²	15pin Mini D-sub	Analog RGB	0.7 Vp-p/75 ohm VGA60, SVGA60, XGA60, WXGA60, SXGA60, UXGA60* ¹ , WUXGA60* ¹ , 1920X1080 (60Hz)
		Sync	Separate: TTL level (Pos./Neg.) Composite sync on Green Video: 0.3 Vp-p Neg.
HDMI	HDMI Connector	Digital YUV Digital RGB	HDMI VGA60, SVGA60, XGA60, WXGA60, SXGA60, UXGA60* ¹ , WUXGA60* ¹ , 1920x1080 (60 Hz), 1080p, 1080i, 720p@50Hz/60Hz, 576p@50Hz, 480p@60Hz, 576i@50Hz, 480i@60Hz, 3840x2160 (30Hz/24Hz/25Hz)* ¹ ,* ⁴ , 4096x2160 (24Hz)* ¹ ,* ⁴
Y/Pb/Pr* ²	15pin Mini D-sub	Component	Y: 1.0 Vp-p/75ohm, Cb/Cr (Pb/Pr): 0.7 Vp-p/75 ohm HDTV/DVD: 1080p, 1080i, 720p@50Hz/60Hz, 576p@50Hz, 480p@60Hz, 576i@50Hz, 480i@60Hz
Output Signal			
DisplayPort	DisplayPort Connector	Digital RGB	DisplayPort Complies with Standard V1.2, applicable to HDCP V1.3
AUDIO			
AUDIO Input	STEREO Mini Jack	Analog Audio	Stereo L/R 0.5 Vrms
	HDMI Connector	Digital Audio	PCM 32, 44.1, 48 KHz (16/20/24bit)
	DisplayPort Connector	Digital Audio	PCM 32, 44.1, 48 KHz (16/20/24bit)
AUDIO Output	STEREO Mini Jack	Analog Audio	Stereo L/R 0.5 Vrms
Speaker Output			External Speaker Jack 15 W + 15 W (8 ohm)
Control		RS-232C In: LAN: Remote IN:	9 Pin D-sub RJ-45 10/100 BASE-T Stereo Mini jack 3.5 Φ
Service port			USB service port for maintenance
Power Supply			3.4 - 1.2 A @ 100-240V AC, 50/60Hz
Operational Environment		Temperature* ³ : Humidity: Altitude:	0 - 40°C / 32 - 104°F 20 - 80% (without condensation) 0 - 3000 m (Brightness may decrease with altitude)
Storage Environment		Temperature: Humidity:	-20 - 60°C / -4 - 140°F 10 - 90% (without condensation) / 90% - 3.5% x (Temp - 40°C) regarding over 40°C
Dimension (without SIDE SEAL)			1211.4 (W) x 682.2 (H) x 98.8 (D) mm / 47.7 (W) x 26.9 (H) x 3.9 (D) inches (without handle) 1211.4 (W) x 682.2 (H) x 101.9 (D) mm / 47.7 (W) x 26.9 (H) x 4.0 (D) inches (with handle)
Weight			26.0 kg (57.3 lbs)
VESA compatible mounting interface			400 mm x 400 mm (M6, 4 Holes)
Power Management			VESA DPM
Plug & Play			VESA DDC2Bi, DDC/CI, DisplayPort
Power supply for Slot 2 type OPTION			16V/3.6 A
Accessories			Setup manual, Power Cord, Video Signal cable (DisplayPort to DisplayPort cable), LAN cable, Clamp x 3, Screw (M4) x 3, Screw (M3) x 1, Spacer x 4, Pin x 4, CD-ROM, Thumbscrew for optional stand x 2

NOTE: Technical specifications are subject to change without notice.

*1: Compressed image.

*2: Common terminal.

*3: When you use option board accessories, please contact your supplier for detailed information.

*4: Displayed text may be blurred.

Pin Assignment

1) Analog multi input (MiniDsub15p): VGA, Y/Pb/Pr

Pin No	Name
1	Red, Y/Pb/Pr_Pr
2	Green, Y/Pb/Pr_Y
3	Blue, Y/Pb/Pr_Pb
4	GND
5	DDC-GND
6	Red-GND
7	Green-GND
8	Blue-GND
9	+5V (DDC)
10	GND
11	NC
12	DDC-SDA
13	H-SYNC
14	V-SYNC
15	DDC-SCL

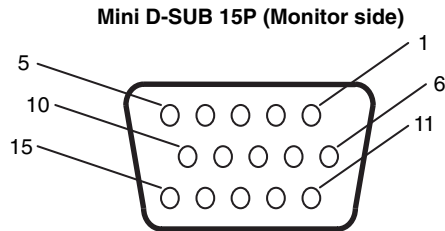

2) RS-232C input/output

Pin No	Name
1	NC
2	RXD
3	TXD
4	NC
5	GND
6	NC
7	NC
8	NC
9	NC

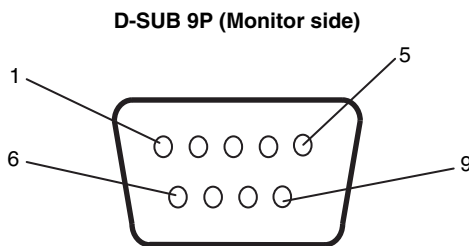

This LCD monitor uses RXD, TXD and GND lines for RS-232C control.

PIP (Picture in Picture) matrix

Main picture	Connector	Sub picture												
		DPORT	DVI	HDMI	VGA	Y/Pb/Pr	OPTION	VIDEO	S-VIDEO	SCART	Y/Pb/Pr2	RGB/HV	HDMI2	HDMI3
		DisplayPort	DVI-D	HDMI	D-Sub	SLOT2	SLOT3							
DPORT	DisplayPort	No	Yes	Yes	Yes	Yes	Yes	Yes	Yes	Yes	Yes	Yes	Yes	Yes
DVI	DVI-D	Yes	No	Yes	Yes	Yes	Yes	Yes	Yes	Yes	Yes	Yes	Yes	Yes
HDMI	HDMI	Yes	Yes	No	Yes	Yes	Yes	Yes	Yes	Yes	Yes	Yes	Yes	Yes
VGA	D-Sub	Yes	Yes	Yes	No	No	Yes	Yes	Yes	Yes	Yes	Yes	Yes	Yes
Y/Pb/Pr		Yes	Yes	Yes	No	No	Yes	Yes	Yes	Yes	Yes	Yes	Yes	Yes
OPTION	SLOT2	Yes	Yes	Yes	Yes	Yes	No	Yes	Yes	Yes	Yes	Yes	Yes	Yes
VIDEO	SLOT3	Yes	Yes	Yes	Yes	Yes	Yes	No	No	No	No	No	No	No
S-VIDEO		Yes	Yes	Yes	Yes	Yes	Yes	No	No	No	No	No	No	No
SCART		Yes	Yes	Yes	Yes	Yes	Yes	No	No	No	No	No	No	No
Y/Pb/Pr2		Yes	Yes	Yes	Yes	Yes	Yes	No	No	No	No	No	No	No
RGB/HV		Yes	Yes	Yes	Yes	Yes	Yes	No	No	No	No	No	No	No
HDMI2		Yes	Yes	Yes	Yes	Yes	Yes	No	No	No	No	No	No	No
HDMI3		Yes	Yes	Yes	Yes	Yes	Yes	No	No	No	No	No	No	No

Manufacturer's Recycling and Energy Information

NEC DISPLAY SOLUTIONS is strongly committed to environmental protection and sees recycling as one of the company's top priorities in trying to minimize the burden placed on the environment. We are engaged in developing environmentally-friendly products, and always strive to help define and comply with the latest independent standards from agencies such as ISO (International Organisation for Standardization) and TCO (Swedish Trades Union).

Disposing of your old NEC product

The aim of recycling is to gain an environmental benefit by means of re-use, upgrading, reconditioning or reclamation of material. Dedicated recycling sites ensure that environmentally harmful components are properly handled and securely disposed. To ensure the best recycling of our products, **NEC DISPLAY SOLUTIONS offers a variety of recycling procedures** and gives advice on how to handle the product in an environmentally sensitive way, once it has reached the end of its life.

All required information concerning the disposal of the product and country-specific information on recycling facilities can be found on our following websites:

<http://www.nec-display-solutions.com/greencompany/> (in Europe),

<http://www.nec-display.com> (in Japan) or

<http://www.necdisplay.com> (in USA).

Energy Saving

This monitor features an advanced energy saving capability. When a Display Power Management signal is sent to the monitor, the Energy Saving mode is activated. The monitor enters a single Energy Saving mode.

Mode	Power consumption	LED colour
Normal Operation*1, *2	Approx. 205 W (X555UNS) Approx. 140 W (X555UNV) Approx. 180 W (UN551S) Approx. 140 W (UN551VS)	Green
Energy Saving Mode*1 (AUTO POWER SAVE)	Less than 2.5 W	Amber
Energy Saving Mode*1 (AUTO STANDBY)	Less than 0.5 W	Red
Power Off	Less than 0.5 W	Red

*1: without any option, with factory settings.

*2: depends on destination.

For additional information visit:

<http://www.necdisplay.com/> (in USA)

<http://www.nec-display-solutions.com/> (in Europe)

<http://www.nec-display.com/global/index.html> (Global)

WEEE Mark (European Directive 2012/19/EU and amendments)



Disposing of your used product: In the European Union

EU-wide legislation as implemented in each Member State requires that used electrical and electronic products carrying the mark (left) must be disposed of separately from normal household waste. This includes monitors and electrical accessories, such as signal cables or power cords. When you dispose of such products, please follow the guidance of your local authority or ask the shop where you purchased the product, or if applicable, follow applicable legislation or agreement you may have. The mark on electrical and electronic products may only apply to the current European Union Member States.

Outside the European Union

If you wish to dispose of used electrical and electronic products outside the European Union, please contact your local authority and ask for the correct method of disposal.