



**LG**

Life's Good

OWNER'S MANUAL

# Multi-touch Overlay Kit

Please read this manual carefully before operating your set and retain it for future reference.

KT-T320 KT-P430

KT-T430

KT-T490

KT-T550

# TABLE OF CONTENTS

## **3 ASSEMBLY AND PREPARATION**

---

- 3 Accessories
- 4 Safety Precautions
- 5 Assembly Instructions

## **11 HOW TO ATTACH THE IR**

---

## **12 INSTALLATION INSTRUCTIONS**

---

- 12 Connecting Touch USB Cable

## **15 BEFORE USE**

---

## **15 TOUCH SPECIFICATIONS**

---

## **15 OS SUPPORT AVAILABILITY**

---

## **16 PRODUCT SPECIFICATIONS**

---

## **20 TROUBLESHOOTING GUIDE**

---

# ASSEMBLY AND PREPARATION

## Accessories

Check your product box for the following items. If there are any missing accessories, contact the local dealer where you purchased your product. The illustrations in this manual may differ from the actual product and accessories.



CD (Owner's Manual) / Cards



M3 x L8 Screw (1 EA)



M3 x L6 Screws  
 KT-T320 : 9 EA  
 KT-T430 / KT-P430 : 14 EA  
 KT-T490 / KT-T550 : 16 EA

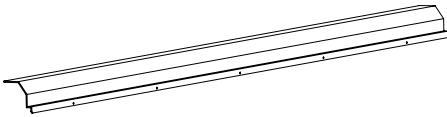

Top Bracket

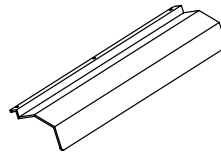

Side Bracket (2 EA)

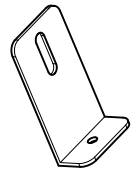

IR Bracket

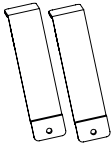

KT-T320  
 Bottom Bracket (2 EA)

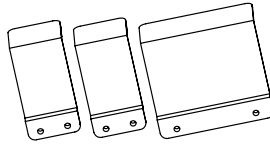

KT-T430 / KT-P430  
 Bottom Bracket (3 EA)

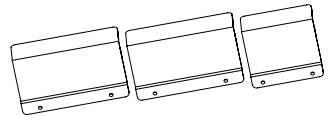

KT-T490 / KT-T550  
 Bottom Bracket (3 EA)



### CAUTION

- Always use genuine components to ensure safety and product performance.
- The product warranty will not cover damage or injury caused by the use of unauthorized components.



### NOTE

- The accessories provided with your product may vary depending on the model or region.
- Product specifications or contents in this manual may be changed without prior notice due to upgrade of product functions.

## Safety Precautions

- If you are a professional installer, please read this manual carefully before installing the product.
- If you are a professional installer, please give this manual to the user after installation and ensure that the user also reads the manual carefully and retains it for future reference.
- After reading the manual, please keep it handy for future reference.



### WARNING

- The product should be installed by a qualified professional specified by the retail store.
  - Product installation by non-qualified personnel is very dangerous and may cause personal injury.
- When moving or replacing the product after installation, contact a qualified installer specified by the retail store.
  - Installation or movement of the product must be carried out by a skilled professional. If an unqualified person moves or installs the product, it may cause safety risks.
- Do not hang the power cable and signal cable on the back of the monitor when mounting the monitor to the wall.
  - Damaged cables may result in fire, electric shock, or damage to the product.
  - Keep the monitor upright when mounting the monitor to the wall.
- The product should be installed where its weight can be fully supported.
  - If the product is installed on a weak surface, the product may fall, causing injury.
  - Check the maximum allowed weight of the wall mount (LSW230B : 40 kg , LSW350B : 50 kg).
- Do not hang on this product. Protect it from severe impact after installation.
  - The product may fall and cause injury.
- Models with the Multi-touch Overlay Kit cannot be installed on stands.
  - The product may fall.

## Assembly Instructions

- The picture may differ from the actual product.

### ! NOTE

- Before installing the product, if there are any water drops or foreign materials on the inner/outer side of the glass, wipe them out with a soft cloth.
- While using the product, if there are any water drops or foreign materials on the inner/outer side of the glass, wipe them out with a soft cloth and install it again.
- Assemble the product in a clean, uncontaminated area to prevent dust or foreign material from entering it.

1 Place a soft cloth on the table and place the Multi-touch Overlay Kit over it as illustrated.

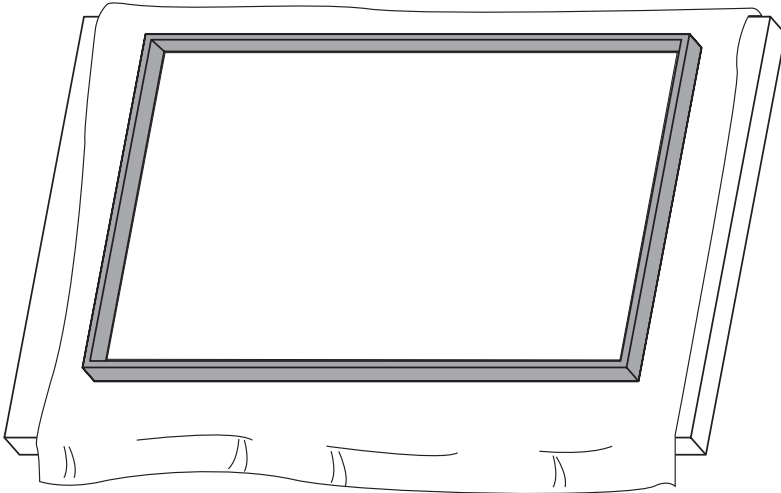

2 Remove the internal protective film using the handle at the upper right corner of the glass as illustrated.

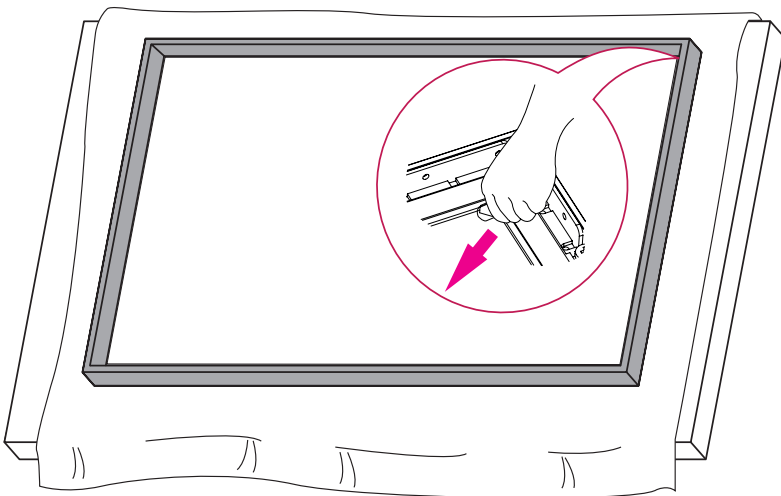

3 Place the display product on the Multi-touch Overlay Kit as illustrated.

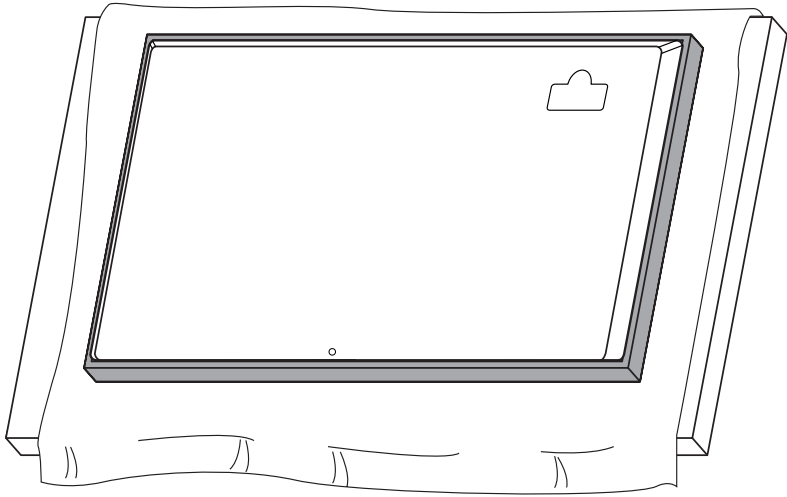

4 Use the screws and the top bracket provided to make the product stationary.

- Number of screws to attach the top bracket:
  - KT-T320: 3 screws
  - KT-T430/ KT-P430/ KT-T490/ KT-T550: 4 screws

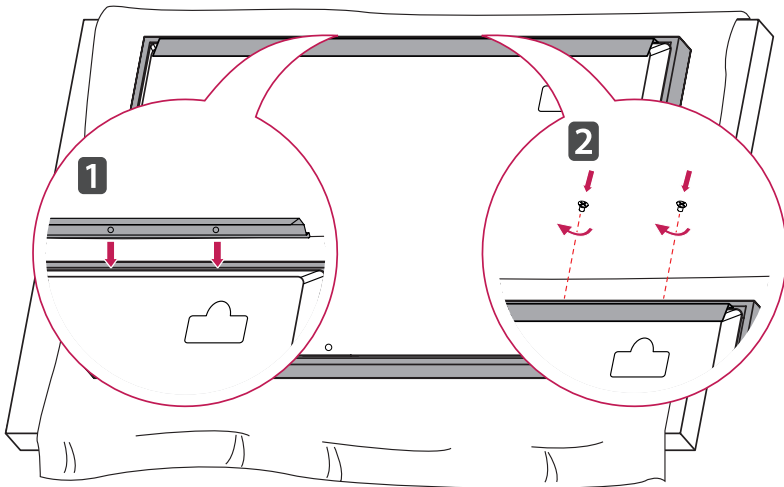

5 Use the screws to attach the product to the bottom bracket provided.

KT-T320

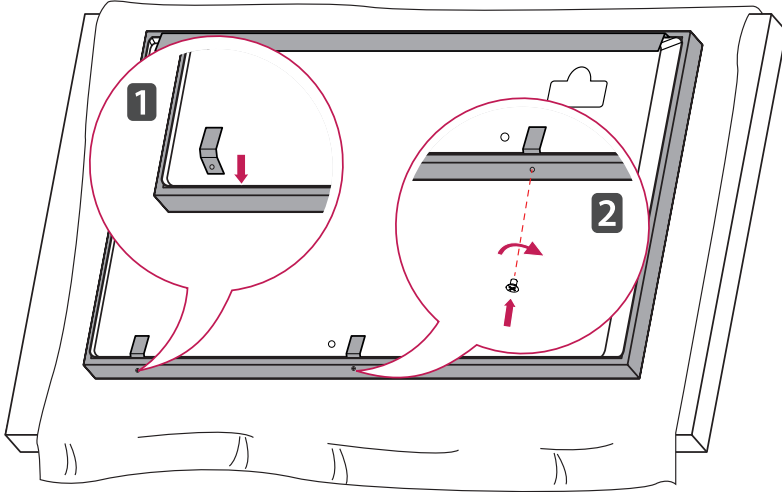

KT-T430 / KT-P430

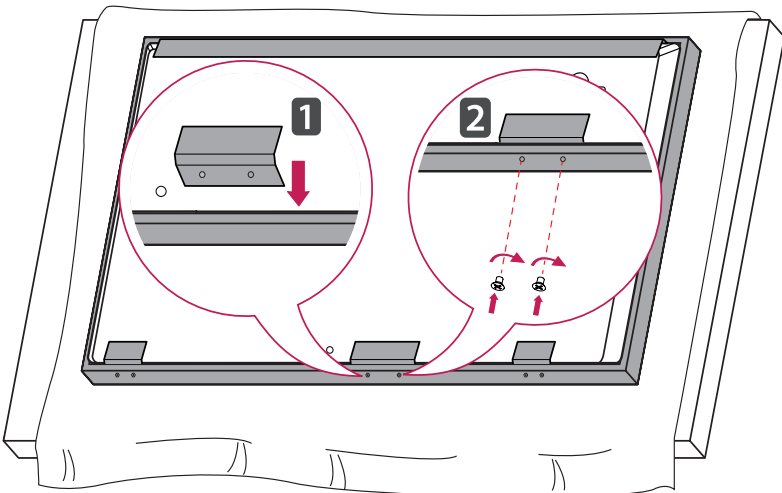

KT-T490/ KT-T550

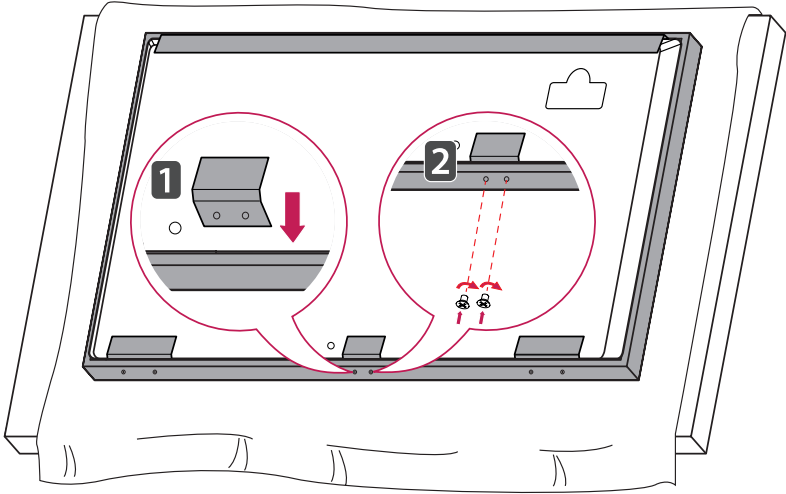

6 Use the screws to attach the product to the side brackets provided.

KT-T320

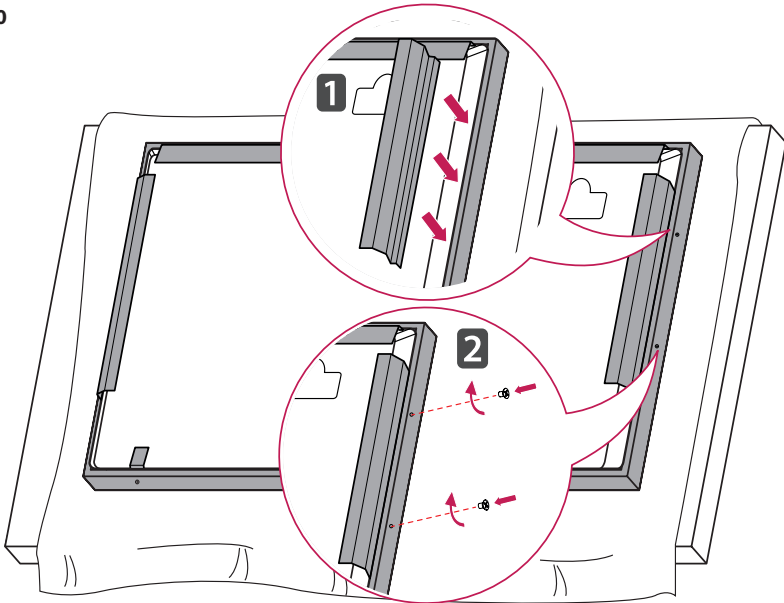



## KT-T430 / KT-P430

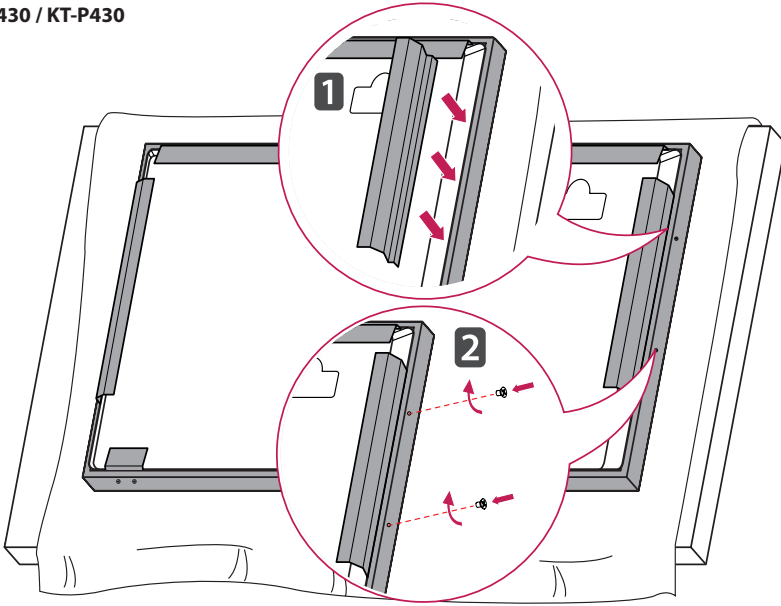

## KT-T490/ KT-T550

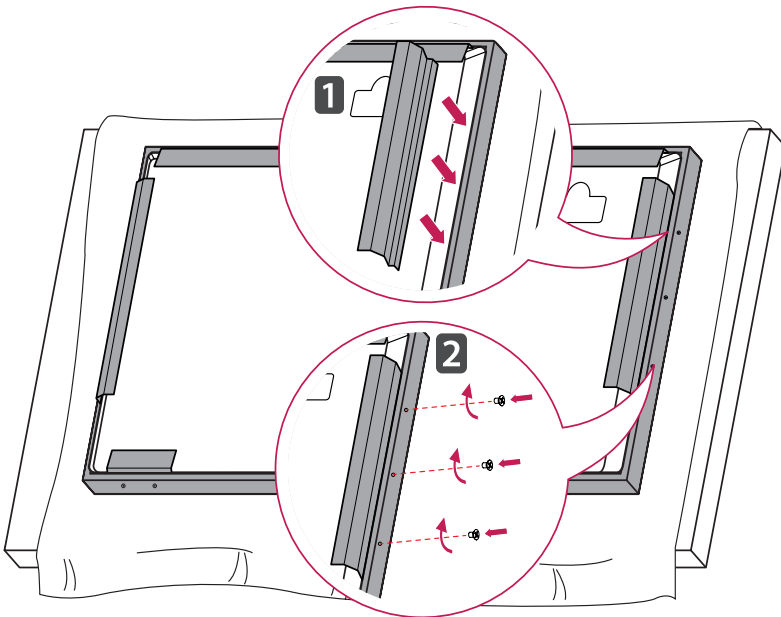

7 Remove the external protective film using the handle at the upper right corner of the glass as illustrated.

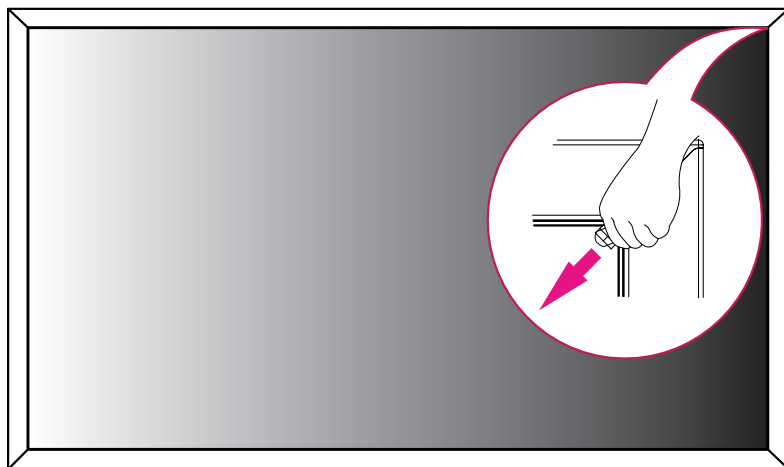

 **CAUTION**

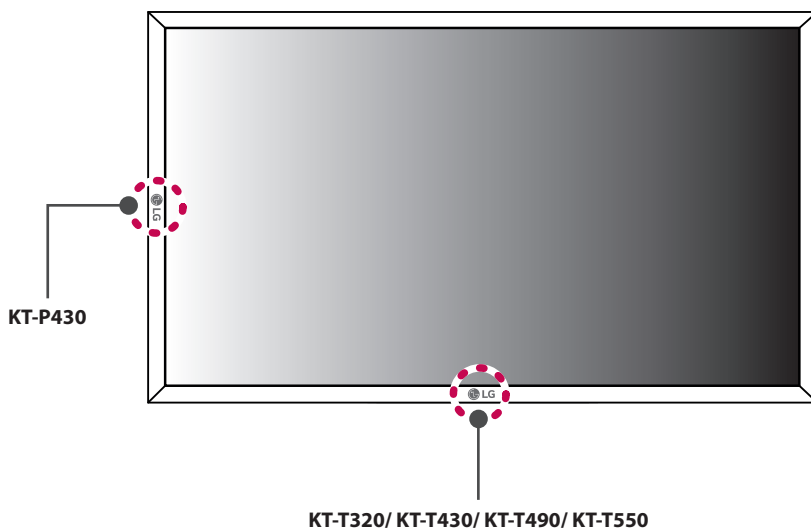

# How to attach the IR

- Only applies to \*\*SM5B,\*\*SM5KB, and \*\*SM3B models.
- The image may differ depending upon the model.

1 Remove the IR sensor from the set.

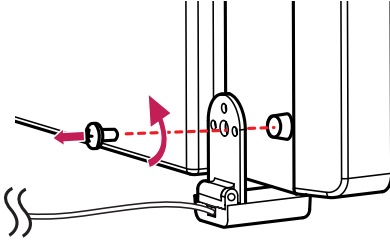

2 Attach the IR sensor to the IR bracket.

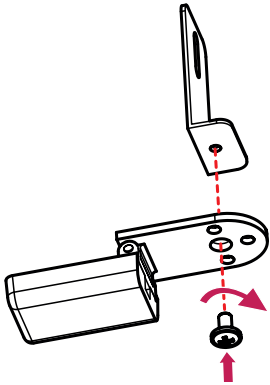

3 Attach the IR sensor and the IR bracket to the set.

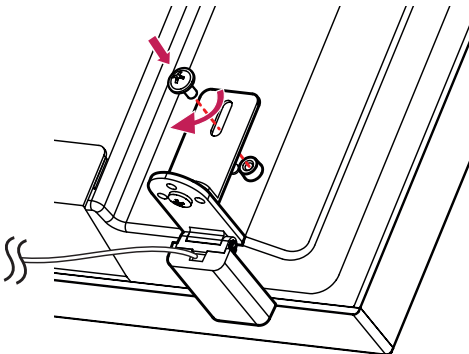

# Installation Instructions

## Connecting Touch USB Cable

Connect the touch USB cable extending from the side of the product to the PC.

Side of product

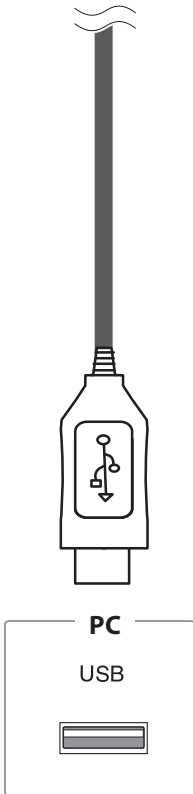

### CAUTION

- The product may not work if you use a USB extension cable.
- While connecting a USB cable or within 3 seconds after connecting it, any tapping on the touch screen may not respond correctly.

Connect the TOUCH USB cable on the side of the product to the USB port on the back of the monitor.

- KT-T320/ KT-T430/ KT-T490/ KT-T550

Back of the Product

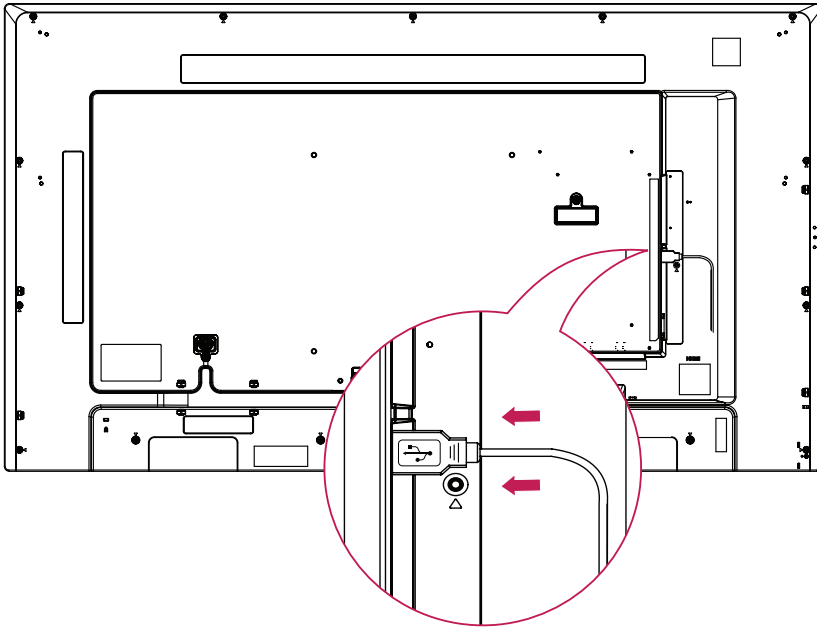

### CAUTION

- It may not be supported depending on the model.
- The image may be different according to the model.
- If there is a change in installation environment (lights etc.), please remove and reconnect the TOUCH USB cable.

- KT-P430

Back of the Product

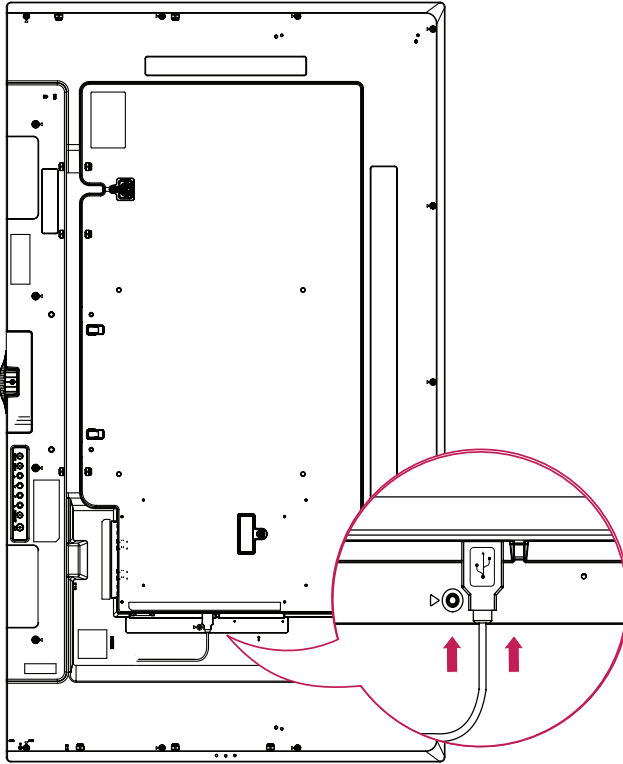

 **CAUTION**

- It may not be supported depending on the model.
- The image may be different according to the model.
- If there is a change in installation environment (lights etc.), please remove and reconnect the TOUCH USB cable.

# Before Use

Set the picture mode of the monitor to the **Game mode**.

For more information on setting the mode, see the owner's manual of the monitor.

## Touch Specifications

Multi-touch	10 points
Supported Operating Systems	Windows 7, Windows 8, Windows 8.1, Android, Linux, Mac OSX
Touch input method	Pens, fingers, gloves, etc.
Touch response time	9 ms (1 point) to 15 ms (10 points)
Touch accuracy	1 mm

Operating voltage	4.65 V $\overline{\sim}$ to 5.25 V $\overline{\sim}$
Power consumption	Max. 1.31 W
Rated Voltage	5 V $\overline{\sim}$ 0.3 A

" $\sim$ " refers to alternating current (AC), and " $\overline{\sim}$ " refers to direct current (DC).

## OS Support Availability

	Mouse/ 1 Point	Digitizer	Gestures/ 10 Points	Plug and Play
<b>Windows 10</b>	○	○	○	○
<b>Windows 8.1</b>	○	○	○	○
<b>Windows 8</b>	○	○	○	○
<b>Windows 7 &amp; Embedded P</b>	○	○	○	○
* Windows 7 Service Pack must be installed.				
<b>Mac OSX</b>	○ <sup>1)</sup>	○ <sup>1)</sup>	○ <sup>1)</sup>	○ <sup>1)</sup>
<b>Linux<sup>2)</sup></b>	○	○	○ (Kernel 3.9 Over)	○ (Kernel 3.9 Over)
<b>Android<sup>2)</sup></b>	○	○	○ (Kernel 3.9 Over)	○ (Kernel 3.9 Over)
<b>Functions</b>	Click, Drag, Double-Click	Mouse Functions, Right-Click, Flicks, Panning with Inertia	Mouse & Digitizer Functions, Press & Tap, Rotate, Zoom In/Out	

- Windows 2000 and earlier versions of Windows are not supported.
- <sup>1)</sup>The correct driver must be installed.
- Operating system applications other than Windows 8 and Windows 7 Professional applications may not support multi-touch.
- <sup>2)</sup>For Android or Linux-powered equipment (set-top boxes etc.), the touch feature may not work if the Touch Driver is not activated in the operating system.

# Product Specifications

The product specifications below may be changed without prior notice due to upgrade of product functions.

Model	Dimensions (mm)			Weight (kg)
	Width	Height	Depth	
<b>KT-T320</b>	756	449	23.5	4.1
<b>KT-T430</b> <b>KT-P430</b>	997	586	23.5	6.5
<b>KT-T490</b>	1,132	660	23.5	8.0
<b>KT-T550</b>	1,266	739	23.5	9.7

Environmental conditions	Operating Temperature	0 °C to 40 °C
	Operating Humidity	10 % to 80 %
	Storage Temperature	-20 °C to 60 °C
	Storage Humidity	5 % to 85 %



**Product Dimensions**

The illustrations in this manual may differ from the actual product and accessories.

The product specifications below may be changed without prior notice due to upgrade of product functions.

(Unit: mm)

KT-T320

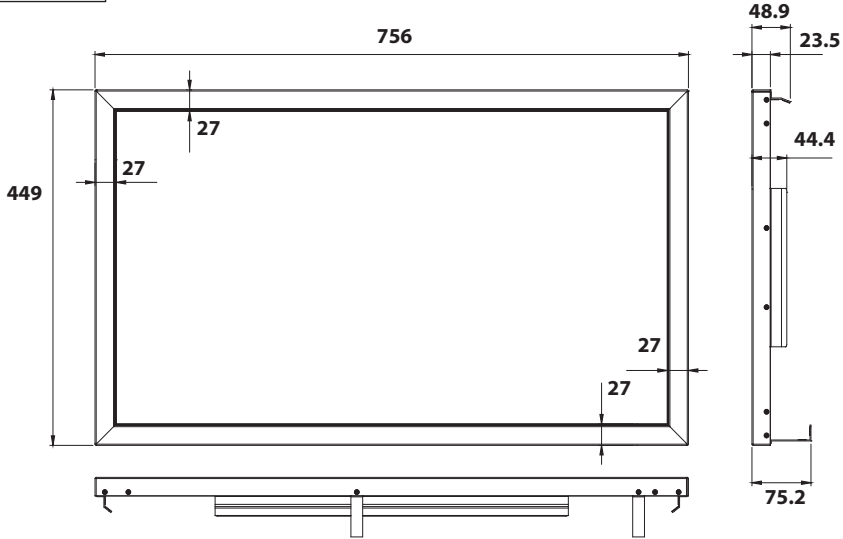

KT-T430

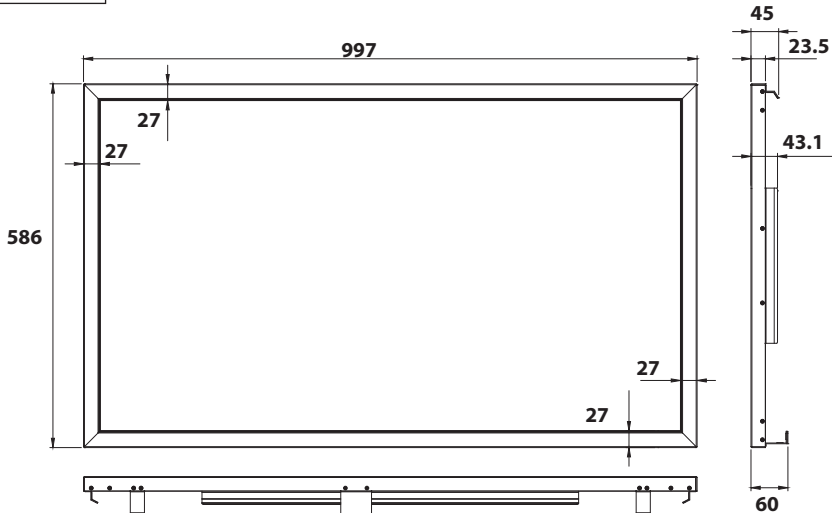

(Unit: mm)

ENGLISH

KT-T490

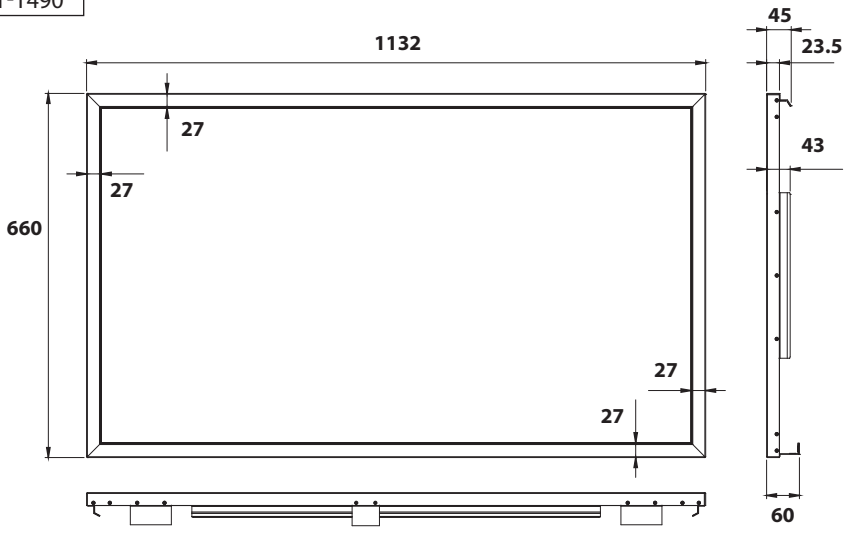

KT-T550

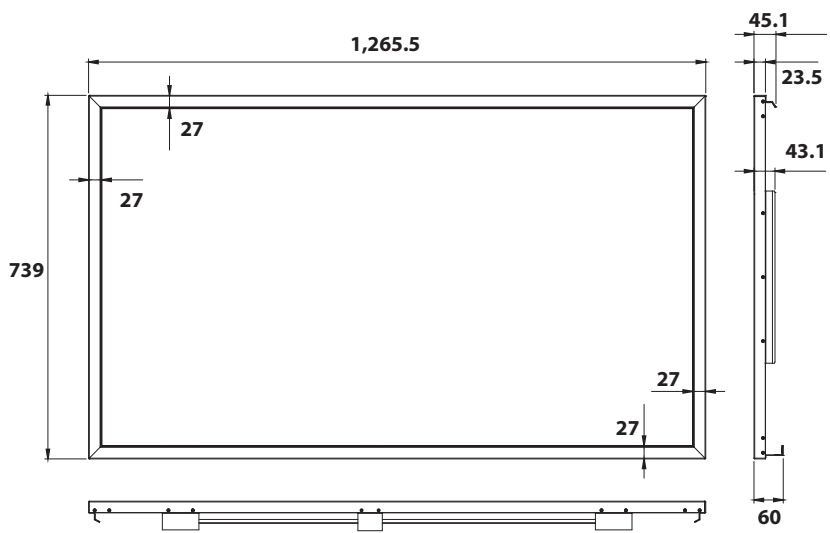

(Unit: mm)

ENGLISH

KT-P430

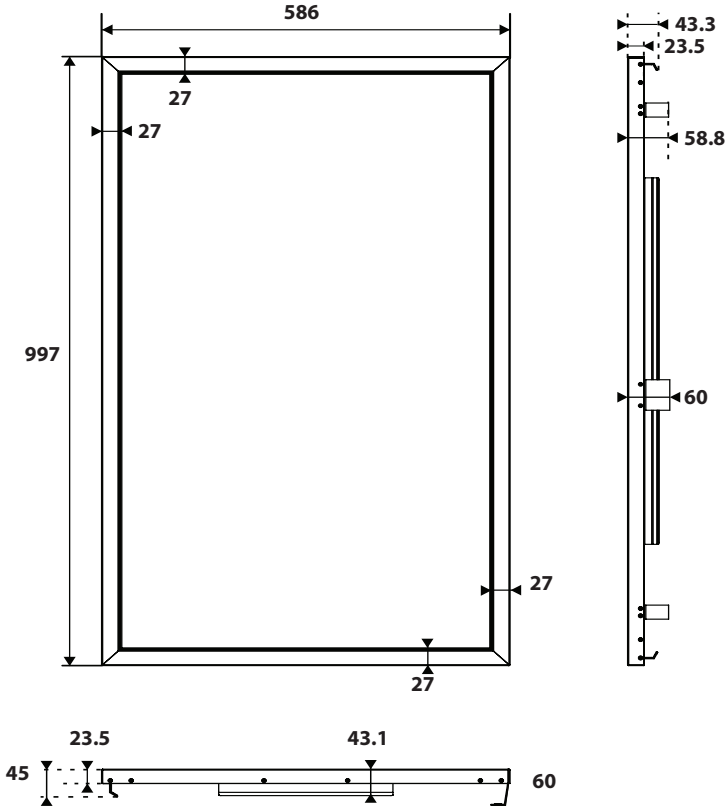

# Troubleshooting Guide

## Touch does not work at all.

Problem	Action
Touch does not work at all.	<ul style="list-style-type: none"> <li>• Check the USB cable connection.               <ul style="list-style-type: none"> <li>- This may occur when the USB cable between PC and monitor is not connected. Check the USB cable and reconnect it.</li> </ul> </li> <li>• Check your PC's power.               <ul style="list-style-type: none"> <li>- This may occur when the PC is powered off. Make sure that your PC's power cord is firmly plugged into a power outlet, then restart your PC.</li> </ul> </li> <li>• Restart your PC.               <ul style="list-style-type: none"> <li>- Touch may not respond when the system is down due to an unstable network.</li> </ul> </li> <li>• Check the signal cable connection.               <ul style="list-style-type: none"> <li>- If your PC and monitor are not connected with a signal cable, touch will not work. Check the signal cable connection.</li> </ul> </li> </ul>
The touch location does not match the touch coordinates.	<ul style="list-style-type: none"> <li>• Use the calibration program supported by your OS or application to make any corrections.</li> </ul>
When using multiple monitors, touching is applied to a monitor other than the one intended.	<ul style="list-style-type: none"> <li>• Set the product as the default monitor.</li> </ul>
10 point multi-touch is not working.	<ul style="list-style-type: none"> <li>• Ensure that your OS supports multi-touch functionality.</li> <li>• Make sure your content supports 10 point multi-touch.               <ul style="list-style-type: none"> <li>- The software used (e.g., Flash Player, Paint, etc.) may not support 10 point multi-touch.</li> </ul> </li> <li>• Restart the software (e.g. Flash Player, Paint, etc.).</li> <li>• Restart your PC.</li> <li>• If the gap between two touch points is 25 mm or less, touch errors may occur.</li> <li>• 10 point multi-touch support may be unstable on the edge of the touch screen.</li> <li>• Using the 10 point multi-touch screen to draw lines may cause partial breakage of the lines.</li> </ul>



The model and serial numbers of the SET are located on the back or one side of the SET. Record it below should you ever need service.

MODEL \_\_\_\_\_

SERIAL \_\_\_\_\_

**WARNING** -This is a class A product. In a domestic environment this product may cause radio interference, in which case the user may be required to take adequate measures.

**Applicable models**

(For details about applicable models, contact the retail store or refer to the Owner's manual.)