



# HP DesignJet 1600 Printer Series

User Guide

Edition 1

© Copyright 2019 HP Development Company, L.P.

### Legal notices

The information contained herein is subject to change without notice.

The only warranties for HP products and services are set forth in the express warranty statements accompanying such products and services. Nothing herein should be construed as constituting an additional warranty. HP shall not be liable for technical or editorial errors or omissions contained herein.



IPv6-ready

### Trademarks

Adobe®, Acrobat®, Adobe Photoshop® and Adobe® PostScript® 3™ are trademarks of Adobe Systems Incorporated.

ENERGY STAR and the ENERGY STAR mark are registered U.S. trademarks.

Microsoft® and Windows® are U.S. registered trademarks of Microsoft Corporation.

PANTONE® is Pantone, Inc.'s check-standard trademark for color.

---

# Table of contents

<b>1 Introduction .....</b>	<b>1</b>
Welcome to your printer .....	2
Printer models .....	2
Safety precautions .....	3
Main components .....	6
Turn the printer on and off .....	7
Front panel .....	9
HP Utility .....	12
HP Print Preview .....	12
Embedded Web Server .....	13
Demo prints .....	13
Configure your printer .....	14
Mobile printing .....	29
Accessibility .....	29
Other sources of information .....	30
<b>2 Paper handling .....</b>	<b>31</b>
General advice .....	32
Load a roll onto the spindle .....	33
Load a roll into the printer .....	35
Unload a roll .....	38
Load a single sheet .....	39
The stacker .....	42
The basket .....	44
View information about the paper .....	44
Paper presets .....	44
Printing paper info .....	45
Move the paper .....	46
Maintain paper .....	46
Change the drying time .....	46
Turn the automatic cutter on and off .....	47
Clean cut .....	47

<b>3 Working with two rolls (T1600dr only)</b> .....	<b>48</b>
Advantages of a multiroll printer .....	49
How the printer allocates jobs to paper rolls .....	49
<b>4 Networking</b> .....	<b>51</b>
Introduction .....	52
Control network protocols .....	52
Front-panel menu items .....	52
Link configuration methods .....	55
Troubleshooting .....	56
<b>5 Printing</b> .....	<b>60</b>
Introduction .....	61
Print from a USB flash drive .....	61
Print from the network folder .....	62
Print from a computer using a printer driver .....	63
Advanced print settings .....	64
<b>6 Mobile printing</b> .....	<b>75</b>
Introduction .....	76
Print from Android .....	76
Print from Chrome OS .....	76
Print and share from the HP Smart App .....	77
Print by email (HP ePrint) .....	77
Mobile specifications .....	77
<b>7 Job queue management</b> .....	<b>78</b>
Job queue in the front panel .....	79
Job queue in the Embedded Web Server or HP DesignJet Utility .....	83
<b>8 Color management</b> .....	<b>87</b>
Introduction .....	88
How colors are represented .....	88
A summary of the color management process .....	88
Color calibration .....	88
Color management from printer drivers .....	90
Color management from the front panel .....	92

<b>9 Practical printing examples .....</b>	<b>93</b>
Print a draft for revision with the correct scale .....	94
Print a PDF multipage job from Adobe Acrobat Reader or Adobe Acrobat Pro .....	95
Print a document with the correct colors .....	97
Print a project .....	104
Print a presentation .....	107
Print and scale from Microsoft Office .....	111
<b>10 Retrieving printer usage information .....</b>	<b>115</b>
Get printer accounting information .....	115
Check usage statistics .....	115
Check usage statistics for a job .....	117
Check cost assignment .....	119
<b>11 Handling ink cartridges and printhead .....</b>	<b>120</b>
About the ink cartridges .....	121
Check the ink cartridges status .....	121
Remove an ink cartridge .....	121
Insert an ink cartridge .....	122
About the printhead .....	124
Check the printhead status .....	124
Remove the printhead .....	125
Insert the printhead .....	128
Storage of anonymous usage information .....	131
Safe mode .....	131
<b>12 Maintaining the printer .....</b>	<b>132</b>
Check printer status .....	133
Clean the exterior of the printer .....	133
Maintain the ink cartridges .....	133
Move or store the printer .....	133
Update the firmware .....	134
Update the software .....	135
Printer maintenance kits .....	135
Secure File Erase .....	135
Disk Wipe .....	136
<b>13 Supplies and accessories .....</b>	<b>137</b>
How to order supplies and accessories .....	138
Introduction to the accessories .....	142

<b>14 Troubleshooting paper issues .....</b>	<b>143</b>
Paper cannot be loaded successfully .....	144
Paper type is not in the driver .....	145
Printer printed on the wrong paper type .....	146
Automatic cut not available .....	146
On hold for paper .....	146
The paper has jammed in the print platen .....	147
The paper has jammed in the stacker .....	152
The printer reports unexpectedly that the stacker is full .....	152
A strip stays on the output tray and generates jams .....	153
Printer displays out of paper when paper is available .....	153
Prints do not fall neatly into the basket .....	153
Sheet stays in the printer when the print has been completed .....	153
Paper is cut when the print has been completed .....	153
Cutter does not cut well .....	153
Roll is loose on the spindle .....	153
Recalibrate the paper advance .....	154
<b>15 Troubleshooting print-quality issues .....</b>	<b>156</b>
General advice .....	158
Horizontal lines across the image (banding) .....	158
Whole image is blurry or grainy .....	159
Paper is not flat .....	160
Print is scuffed or scratched .....	160
Ink marks on the paper .....	161
Black horizontal lines on yellow background .....	161
Black ink comes off when you touch the print .....	162
Edges of objects are stepped or not sharp .....	162
Edges of objects are darker than expected .....	162
Horizontal lines at the end of a cut sheet print .....	162
Vertical lines of different colors .....	163
White spots on the print .....	163
Colors are inaccurate .....	163
Colors are fading .....	164
Image is incomplete (clipped at the bottom) .....	164
Image is clipped .....	164
Some objects are missing from the printed image .....	165
Lines are too thick, too thin or missing .....	166
Lines appear stepped or jagged .....	166
Lines print double or in the wrong colors .....	167
Lines are discontinuous .....	167

Lines are blurred .....	168
Line lengths are inaccurate .....	168
Image Diagnostics Print .....	169
If you still have a problem .....	172
<b>16 Troubleshooting ink cartridge and printhead issues .....</b>	<b>173</b>
Cannot insert an ink cartridge .....	174
Ink cartridge status messages .....	174
Cannot insert the printhead .....	174
The front-panel display recommends reseating or replacing the printhead .....	174
Clean the printhead .....	175
Align the printhead .....	175
Printhead status messages .....	176
<b>17 Troubleshooting general printer issues .....</b>	<b>177</b>
Printer does not print .....	178
Front panel fails to initialize .....	178
Printer seems slow .....	179
Communication failures between computer and printer .....	179
Cannot access the Embedded Web Server .....	179
Cannot access the network folder .....	180
Cannot connect to the Internet .....	180
Web Services issues .....	180
Automatic file system check .....	180
Alerts .....	181
<b>18 Front-panel error messages .....</b>	<b>182</b>
System error log .....	182
<b>19 HP Customer Care .....</b>	<b>183</b>
Introduction .....	184
HP Professional Services .....	184
Customer Self Repair .....	185
Contact HP Support .....	185
<b>20 Printer specifications .....</b>	<b>187</b>
Functional specifications .....	188
Mobile printing specifications .....	190
Physical specifications .....	190
Memory specifications .....	190

Power specifications .....	191
Environmental specifications .....	191
Acoustic specifications .....	191
Glossary .....	192
Index .....	195



---

# 1 Introduction

- [Welcome to your printer](#)
- [Printer models](#)
- [Safety precautions](#)
- [Main components](#)
- [Turn the printer on and off](#)
- [Front panel](#)
- [HP Utility](#)
- [HP Print Preview](#)
- [Embedded Web Server](#)
- [Demo prints](#)
- [Configure your printer](#)
- [Mobile printing](#)
- [Accessibility](#)
- [Other sources of information](#)

## Welcome to your printer

Your printer is a color inkjet printer designed for printing high-quality images on paper up to 914 mm (36 in) wide. Some major features of the printer are shown below:

- Print resolution of up to 2400 × 1200 optimized dpi, from a 1200 × 1200 dpi input, using the **Best** print-quality option, the **Maximum Detail** option and photo paper.
- The printer can be controlled from its front panel or from a remote computer using the Embedded Web Server, HP DesignJet Utility, or HP Click Printing Software (see <http://www.hp.com/go/designjetclick>).
- Touch-sensitive front panel in color, with an intuitive graphical user interface.
- Job previews in the front panel.
- Job previews on remote computers.
- Includes Web-connected features such as automatic firmware updates, HP ePrint, and Mobile Printing.
- Driverless printing: Files in common graphical formats can be printed directly without needing a printer driver. Just insert a USB flash drive or use HP Click Printing Software.
- Paper flexibility and automatic easy load, see [Paper handling on page 31](#), with information and presets accessible from the front panel and the HP DesignJet Utility.
- Handles cut-sheet and roll paper.
- Six-ink system.
- Accurate and consistent color reproduction with automatic color calibration.
- Economode for printing economically.
- Two rolls loaded at once (T1600dr only) provide fast and easy switching between different rolls, or long runs of unattended printing.
- High productivity features such as job previewing and nesting using HP Click Printing Software.
- Ink and paper usage information available from the Embedded Web Server, see [Embedded Web Server on page 13](#).
- Access to the online HP Support Center (see [HP Support Center on page 184](#)).

## Printer models

This guide covers the following printer models, normally referring to them by their short names for brevity.

Full name	Short name
HP DesignJet T1600	T1600
HP DesignJet T1600 PostScript Printer	T1600 PS
HP DesignJet T1600dr	T1600dr
HP DesignJet T1600dr PostScript Printer	T1600dr PS

# Safety precautions

Read these safety precautions before using your printer. Also read your local Environmental, Health, and Safety regulations.

This equipment is not suitable for use in locations where children are likely to be present.

For any maintenance or part replacement, follow the instructions provided in HP documentation to minimize safety risks and to avoid damaging the printer.

## General safety guidelines

There are no operator-serviceable parts inside the printer except those covered by HP's Customer Self Repair program (see <http://www.hp.com/go/selfrepair>). Refer servicing of other parts to qualified service personnel.

Turn off the printer and call your service representative in any of the following cases:

- The power cord or plug is damaged.
- The printer has been damaged by an impact.
- There is any mechanical or enclosure damage.
- Liquid has entered the printer.
- There is smoke or an unusual smell coming from the printer.
- The printer has been dropped.
- The printer is not operating normally.

Turn off the printer in either of the following cases:

- During a thunderstorm.
- During a power failure.

Take special care with zones marked with warning labels.

Ventilation measures for your location, whether office, copy room, or printer room, should meet local environmental health and safety (EHS) guidelines and regulations.

## Electrical shock hazard

---

 **WARNING!** The internal circuits of the built-in power supplies and power inlet operate at hazardous voltages capable of causing death or serious personal injury.

---

Unplug the printer's power cord before servicing the printer.

The printer requires a building installation circuit breaker, which must meet the requirements of the printer and should be in accordance with the Electrical Code requirements of the local jurisdiction of the country in which the equipment is installed.

To avoid the risk of electric shock:

- The printer should be connected to earthed mains outlets only.
- Avoid overloading the printer's electrical outlet with multiple devices.

- Do not remove or open any closed system covers or plugs.
- Do not insert objects through slots in the printer.
- Take care not to trip over the cables when walking behind the printer.
- Insert the power cord securely and completely into the wall socket and printer inlet.
- Never handle the power cord with wet hands.

## Fire hazard

To avoid the risk of fire, take the following precautions:

- The customer is responsible for meeting the printer's requirements and the Electrical Code requirements according to the local jurisdiction of the country where the printer is installed. Use the power supply voltage specified on the nameplate.
- Use only the power cord supplied by HP with the printer. Do not use a damaged power cord. Do not use the power cord with other products.
- Do not insert objects through slots in the printer.
- Take care not to spill liquid on the printer. After cleaning, make sure all components are dry before using the printer again.
- Do not use aerosol products that contain flammable gases inside or around the printer. Do not operate the printer in an explosive atmosphere.
- Do not block or cover the openings of the printer.

## Mechanical hazard

The printer has moving parts that could cause injury. To avoid personal injury, take the following precautions when working close to the printer.

- Keep your clothing and all parts of your body away from moving parts.
- Avoid wearing necklaces, bracelets, and other hanging objects.
- If your hair is long, try to secure it so that it will not fall into the printer.
- Take care that sleeves or gloves do not get caught in moving parts.
- Do not operate the printer with covers bypassed.
- If you need to replace the cutter assembly, take care not to cut yourself on the sharp cutting edge.
- Internal fan blades are hazardous moving parts. Disconnect the printer before servicing.
- Never insert your hands into the printer while it is printing, due to the moving parts inside.

## Heavy paper hazard

Special care must be taken to avoid personal injury when handling heavy papers.



- Handling heavy paper rolls may require more than one person. Care must be taken to avoid back strain and/or injury.
- When handling heavy paper rolls, wear personal protective equipment, including boots and gloves.
- Follow your local Environmental Health and Safety regulations for handling heavy paper rolls.

## Ink handling



HP recommends that you wear gloves when handling ink supplies.

## Warnings and cautions

The following symbols are used in this manual to ensure the proper use of the printer and to prevent the printer from being damaged. Follow the instructions marked with these symbols.

-  **WARNING!** Failure to follow the guidelines marked with this symbol could result in serious personal injury or death.
-  **CAUTION:** Failure to follow the guidelines marked with this symbol could result in minor personal injury or damage to the printer.

## Warning labels

Label	Explanation
	Electric shock hazard. Power Supply inside that operates at hazardous voltages. Disconnect all power sources before servicing.  Before starting, read and follow the operating and safety instructions.
	Moving part. Keep your fingers and hands away from the moving paper system.
	Moving parts. Rotating roll bar. Keep hands out.

-  **NOTE:** The final label position and its size on the printer may vary slightly, but labels should always be visible and close to the potential risk area.

# Main components

The following front and rear views of the printer illustrate the main components.

## Front view

 **NOTE:** This illustration shows the T1600dr.

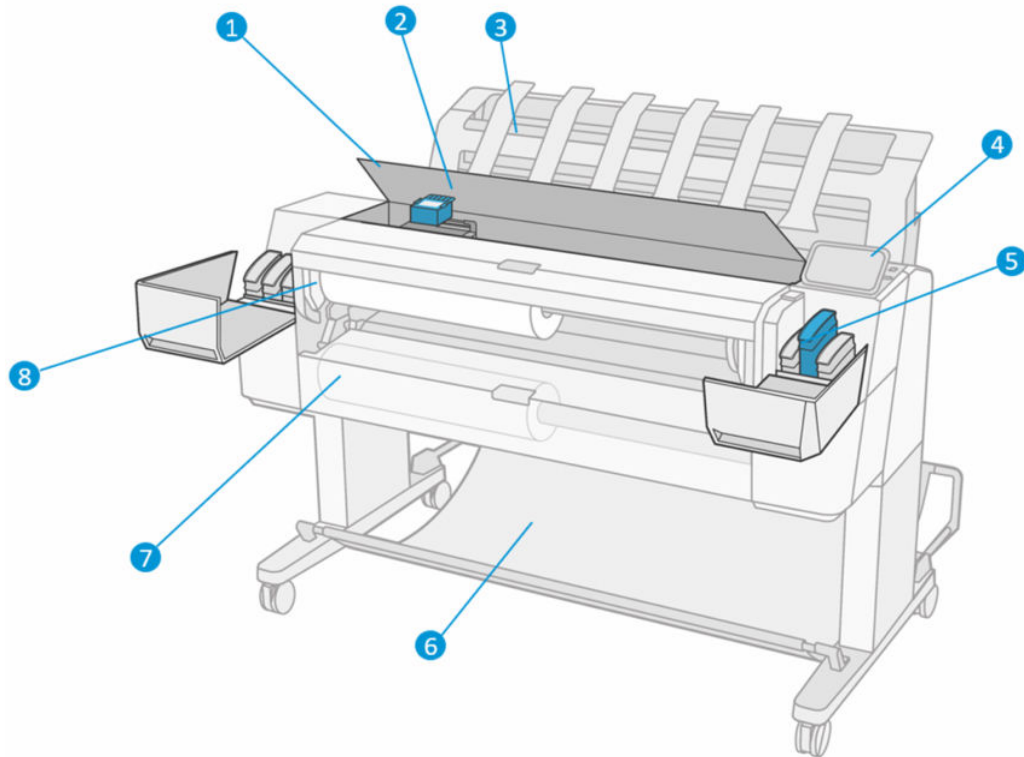

1. Window
2. Printhead
3. Stacker
4. Front panel
5. Ink cartridge slot
6. Basket
7. Lower roll cover ( T1600dr only)
8. Upper roll cover

## Rear view

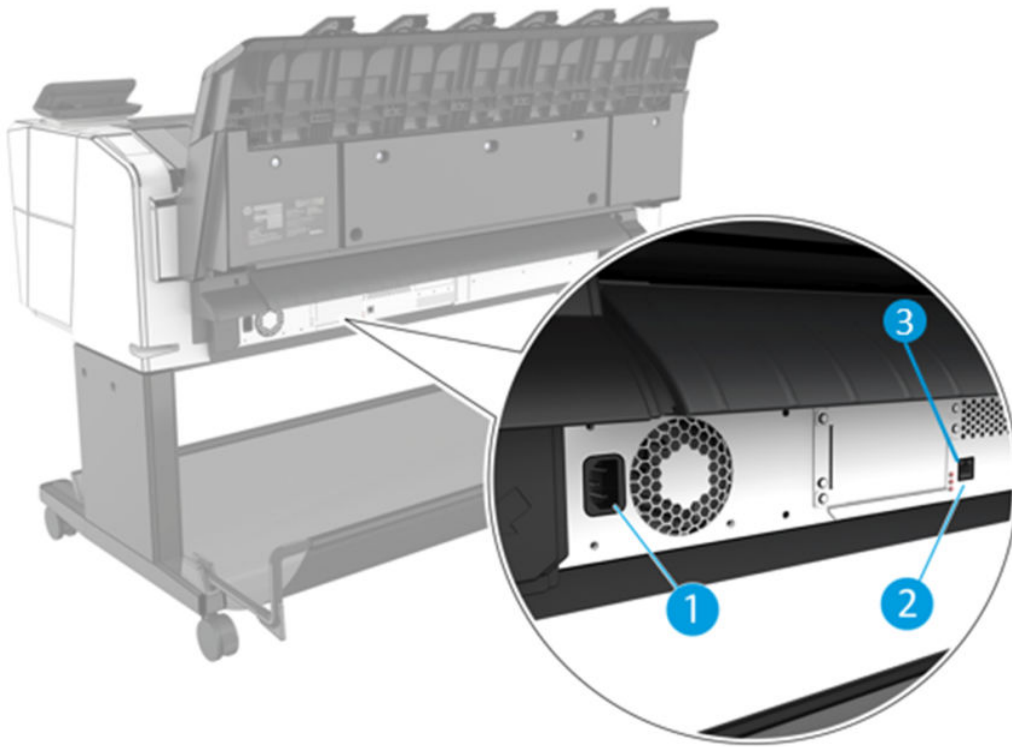

1. Power socket
2. Gigabit Ethernet port, to connect to a network
3. Diagnostic LEDs, to be used by service engineers

The Hi-Speed USB host port is on the other side of the printer, beside the front panel.

## Turn the printer on and off

 **TIP:** The printer can be left powered on almost without wasting energy. Leaving it on improves response time and overall system reliability. When the printer has not been used for a certain period of time (the default time is determined by Energy Star), it saves power by going into sleep mode. However, any interaction with the printer's front-panel display, or sending a new job to print, returns it to active mode, and it can resume printing immediately. To change the sleep mode time, see [Change system options on page 11](#).

 **NOTE:** In sleep mode, the printer performs maintenance service to the printheads from time to time. This avoids long preparation times after long idle periods. Therefore, it is strongly recommended to leave the printer powered on or in sleep mode to avoid wasting ink and time.

If you want to turn the printer on or off or reset the printer, the normal and recommended method is to use the power key beside the front panel.

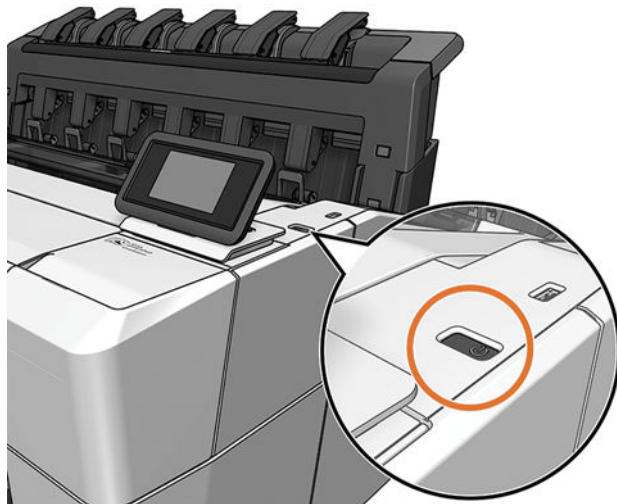

However, if you plan to store the printer for a long period or the power key does not seem to work, you are recommended to unplug the power cord at the rear.

To turn it back on, plug in the power cord.

When the printer is powered back on, it takes about three minutes to initialize and check and prepare the printheads. Preparing the printheads takes about 75 seconds. However, if the printer has been off for six weeks or more, preparing the printheads could take up to 45 minutes.



## Front panel

The front panel is a touch-sensitive screen with a graphical user interface, located on the front right of the printer.

It gives you complete control of your printer: from the front panel, you can view information about the printer, change printer settings, monitor printer status, and perform tasks such as supplies replacement and calibrations. The front panel displays alerts (warning and error messages) when necessary.

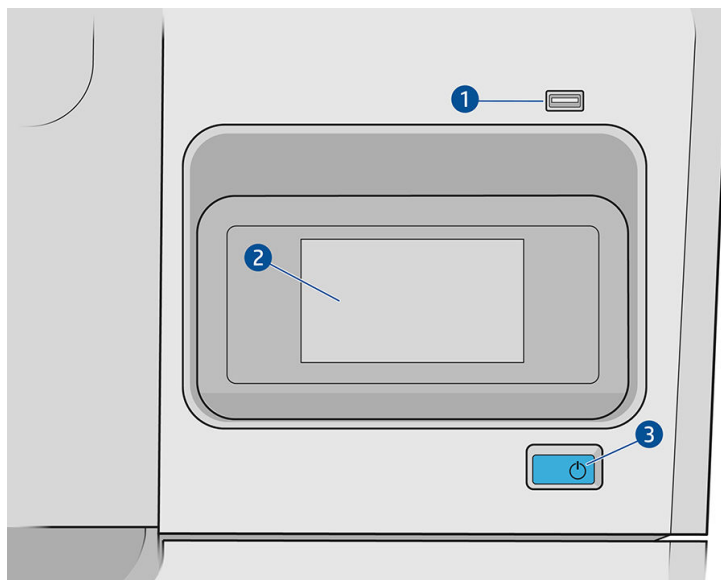

It includes the following components:

1. A Hi-Speed USB host port, intended for connecting a USB flash drive, which can provide files to be printed. When a USB flash drive is inserted, a USB icon  is displayed on the front panel's all-apps page.
2. The front panel itself: a 4.3 inch, full-color, touch-sensitive screen with a graphical user interface.
3. The power key, with which you can turn the printer on or off, or wake up from sleep mode.

The front panel has a large central area to display dynamic information and icons.

## Home pages

There are two top-level pages that you can move between by sliding your finger across the screen:

- The all-apps page displays a list of all apps available in your printer, and the status of each of them.

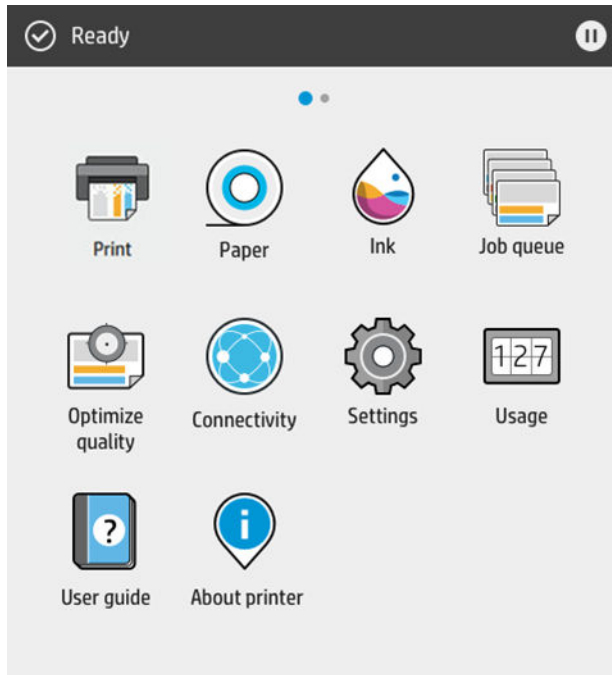

- If you swipe left to the widget page, you can see at a glance the status of ink and paper supplies.

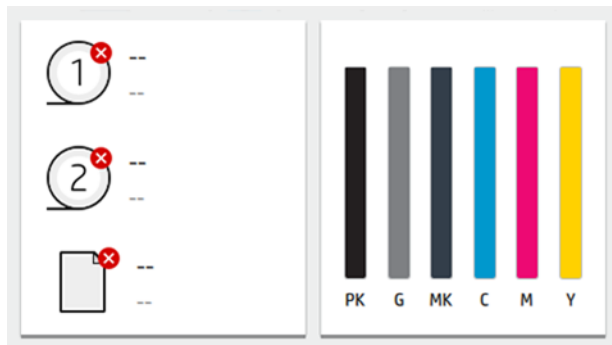

- At the top of the all-apps page there is a dashboard that displays alerts related to the main functions of the printer. Swipe down the dashboard to access the Status Center.

## Dim mode

After some time with no activity (5 minutes by default), the printer goes to dim mode, which reduces the brightness of the front panel by 25%. Any activity, such as the use of the front panel or the arrival of a print job, ends dim mode and restores normal brightness. After some time in dim mode (15 minutes by default), the printer changes to sleep mode. The time periods can be changed from the front panel.

## Sleep mode

Sleep mode puts the printer into a reduced power state after a period of inactivity, turning off some elements to save energy. Printer features can be enabled from this mode, and the printer maintains network connectivity, waking up only as necessary.

The printer can be woken from sleep mode any of the following ways:

- By pressing the power button
- By opening a door
- By sending a print job

The printer wakes up in several seconds, more quickly than if it is completely turned off. While in sleep mode, the power button blinks.

To change the time that elapses before sleep mode, see [Change system options on page 11](#).

Printer Monitoring (with the Print Spooler) and Remote Printer Management with the HP Utility and Web JetAdmin continue to be available during sleep mode. Some remote management tasks offer the option of remotely waking up the printer if needed to perform the task.

## Change the language of the front-panel display

If you can understand the current front-panel display language, tap , then **System** > **Language**.

The language selection menu should now appear on the front-panel display. Tap your preferred language.

The available languages are English, Portuguese, Spanish, Catalan, French, Dutch, Italian, German, Polish, Russian, Simplified Chinese, Traditional Chinese, Korean, and Japanese.

## Change system options

You can change various printer system options from the front panel. Tap , then **System**.

- **Language**.
- **Display brightness** to change the brightness of the front-panel display.
- **Date and time options** to view or set the printer's date and time.
- **Unit selection** to change the units of measurement in the front-panel display. Select **English** or **Metric**. By default, units are set to **Metric**.
- **Speaker volume** to change the volume of the printer's loudspeaker. Select **Off**, **Low**, or **High**.
- **Power options** > **Printer sleep** to change the length of time the printer waits before going into sleep mode (see [Sleep mode on page 11](#)). You can set the time from 5 to 60 minutes. The default time is <15 minutes (total time including 5 minutes in dim mode).
- **Power options** > **Auto-off due to inactivity** to turn off the printer automatically after 120 minutes of inactivity.
- **Restore factory settings** to restore the printer settings to their original values as set in the factory. This option restores all of the printer settings except the administrator password and the paper presets.
- **Firmware update** to configure the automatic firmware update.

# HP Utility

The HP Utility is a Windows only tool that enables you to manage your printer from a computer with a TCP/IP connection.

You can install the HP Utility from <http://www.hp.com/go/DesignJetT1600/drivers>.

## How to launch the HP Utility

Start the HP DesignJet Utility from the  icon on your taskbar or from the Start menu > **HP** > **HP DesignJet Utility**. This launches the HP DesignJet Utility, showing the printers installed on your computer. When you open the HP DesignJet Utility for the first time, it may offer you an automatic update with enhanced functionality that we recommend you to accept.

When you select your printer in the left pane, everything that appears in the right pane is specific to that printer.

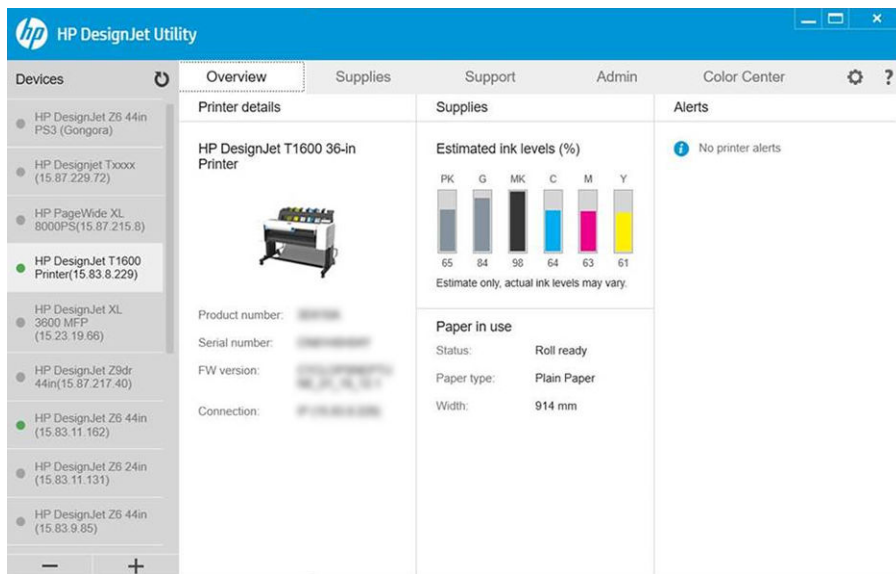

## HP Print Preview

The HP Print Preview application enables you to see a basic preliminary preview of how your job will be printed. This application is available only under Windows. You can install the HP Print Preview by downloading the integrated installer from <http://www.hp.com/go/DesignJetT1600/drivers>.

If you use a V4 PDF driver, you can change the rotation, scaling, color mode and the paper source settings in the application before you print.

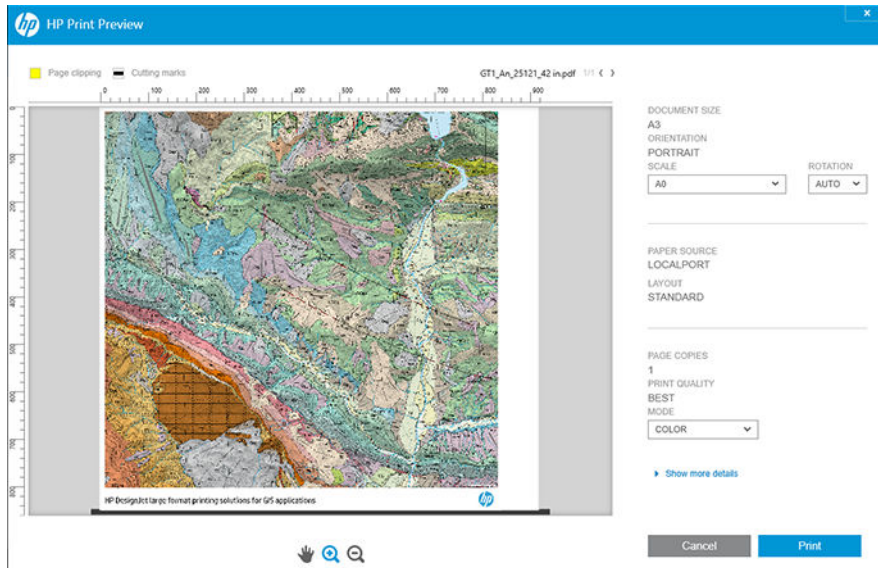

## Embedded Web Server

The following browsers are known to be compatible with the Embedded Web Server:

- Microsoft Internet Explorer 11 and later for Windows 7 and later
- Apple Safari 8 and later for OS X 10.10 and later
- Mozilla Firefox (latest version)
- Google Chrome (latest version)

To use the Embedded Web Server on any computer, open your Web browser and enter the printer's IP address in the browser's address bar. You can find your printer's IP address in the printer's front panel: tap  and then **Network**. See [Configure your printer on page 14](#).

---

 **NOTE:** Your browser may display a security warning when you enter the IP address. If you have entered the correct address, it is safe to ignore the warning and continue to access the Embedded Web Server.

---

The Embedded Web Server window displays a menu used to access all the supported functionality. It supports the following languages: English, Portuguese, Spanish, Catalan, French, Dutch, Italian, German, Polish, Russian, Simplified Chinese, Traditional Chinese, Korean, and Japanese. It uses the language that you specified in your Web browser options. If you specify a language that it cannot support, it is displayed in the language selected in the printer, or else in English.

To change the language, change your Web browser's language setting. To complete the change, close and reopen your Web browser.

## Demo prints

The demo prints give various kinds of information about your printer. They can be requested from the front panel.

Before requesting a demo print, check that the printer and the paper are ready for printing.

- The loaded paper should be at least A3 landscape—419 mm (16.53 in) wide—otherwise the print may be clipped.
- The front panel should be displaying the **Ready** message.

To print a demo print, tap , then scroll down and tap **Internal prints**, then **Demo prints**, and select a print. The following prints are available:

- Cad Color
- GIS
- Render
- Architectural Presentation Panel

## Configure your printer

### Connect the printer to your network



The printer is able to configure itself automatically for most networks, in a similar way to any computer in the same network. The first time you connect it to a network, this process may take a few minutes.

Once the printer has a working network configuration, you can check its network address from the front panel: tap .

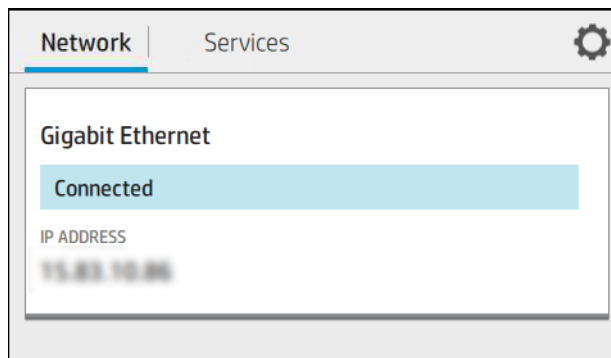

 **TIP:** Consider making a note of the printer's IP address, because you may need it during the setup process of connecting your Windows or Mac OS computer clients.



### Modify network configuration

To modify the current network configuration, go to the front panel and tap , then , then **Network > Gigabit Ethernet**. From here it is possible, though not normally necessary, to change the settings manually; this can also be done remotely using the Embedded Web Server.

For full details of the available connectivity settings, see [Networking on page 51](#).

If you accidentally misconfigure the printer's network settings, you can restore the network settings to their factory values from the front panel: tap , then , then **Network > Restore factory settings**. Then you must restart the printer. This automatically provides a working network configuration for most networks. The printer's other settings remain unchanged.

## Install your printer under Windows

The following instructions apply if you intend to print from software applications using a printer driver. See [Printing on page 60](#) for alternative ways of printing.

Before you begin, check your equipment:

- The printer should be set up and on.
- The Ethernet switch or router should be on and functioning correctly.
- The printer and the computer should be connected to the network (see [Connect the printer to your network on page 14](#)).

Now you can proceed to install the printer software and connect to your printer.

### Printer software installation

1. Make a note of the printer's host name and IP address from the front panel (see [Connect the printer to your network on page 14](#)).
2. Install the printer software from <http://www.hp.com/go/DesignJetT1600/drivers>, following the software installation instructions. By default, the following driver is installed:
  - Non-PostScript printers: The raster driver
  - PostScript printers, with Windows 7 or Windows Server 2008R2: The PostScript driver
  - PostScript printers, with Windows 8, Windows Server 2012, or later: The PDF driver
3. Once downloaded, open it, and follow on-screen steps.

If your computer fails to find any printers on the network, the **Printer Not Found** window is displayed, which helps you to try to find your printer. If you have a firewall in operation; you may have to disable it temporarily in order to find the printer. You also have the options of searching for the printer by its hostname, IP address or MAC address.

## Uninstall the printer software under Windows

Use the Control Panel to uninstall the software, in the same way as you can uninstall any other software.

## Connect a computer to the printer by network (Mac OS X)

HP Click is the recommended way to connect with your printer to a network. See <http://www.hp.com/go/clickDesignJet> for installation instructions.



## Set up printer services

You can set up the following services:

- Receive automatic firmware updates
- Enable email printing
- Enable additional printer services

A network connection is required, so the printer will test its own connectivity. Remember to connect the network cable to the printer.

Each printer service can be enabled or disabled individually as explained below.

During initial printer setup, you are asked whether you want to enable these services. That decision can be changed later by tapping , then  at the top of the page, then **Services** > **Data Collection & HP Privacy Statement**.

If you are part of the HP Partner Link Pay-per-use service, tap , then **Services** > **...** > **Register new service** in order to register the printer service.

## Verify printer connection to HP

You can check that the printer is able to connect to HP services by tapping  and viewing the status there. You can see detailed information by clicking the Network or Service card.

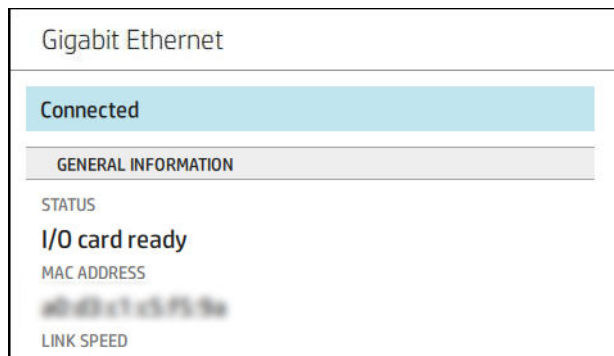



If there is any problem connecting to HP, you will be provided with a description of the problem and some possible solutions.

## Enable email printing with HP ePrint

The HP Connected service makes it easy to send jobs to your printer by attaching them to an email message.



You must accept the **Data Collection & HP Privacy Statement** in order to use HP Connected.

To enable email printing, in the front panel, tap , then  at the right top corner of the page, then **Services** > **HP Connected** > **Setup Web Services**. A printer email address and printer code are assigned to the printer.

To see your printer email address, tap  >  in the right top corner of the page, then **Services** > **HP Connected** > **Printer email address**.

Alternatively, you can configure it from the Embedded Web Server, Go to the **HP Web Services** menu and click **Enable HP web Services** to register and enable HP ePrint.





If you are the printer administrator, log in at HP Connected (<http://www.hpconnected.com>) to customize your printer's email address or manage printer security for remote printing. Refresh the printer's email address from the front panel, tap  >  in the right top corner of the page, then **Services** > **HP Connected** > **Printer email address**.





Visit <http://www.hpconnected.com> to register yourself and your printer (using the printer code).

## HP ePrint job policies

By default, the jobs sent by email are directly printed. To change the settings, tap , then  at the right top corner of the page, then **Services > HP Connected > HP ePrint jobs**.

You can select the roll to be used for HP ePrint jobs, or let the printer decide (save paper).

## Configure ePrint connectivity service

You can remove the connection to HP ePrint if required for security. At the front panel, tap , then  at the right top corner of the page, then **Services > HP Connected > Remove Web Services**.

To use remote printing again, you will need to set it up again from scratch.

## Configure firmware updates

You can choose from the Embedded Web Server or from the front panel whether and how to download firmware updates.

---

 **NOTE:** If an administrator password has been set, it will be required to change these settings.

---

- **In the Embedded Web Server:** Click **About printer > Firmware update**.
- **Using the front panel:** Tap , then **System > Firmware update**.

The following settings are available:

- **Check for updates automatically:** The printer will inform you when new firmware is available.
- **Download new firmware automatically:** The printer will automatically download new firmware whenever it becomes available. Deactivate this option to download new firmware manually.

---

 **NOTE:** Downloading the firmware does not mean that you have installed it in your printer. To install the new firmware, you must confirm the installation manually.

---

- **Firmware update history.**

## LDAP Configure the email address book

The printer uses Lightweight Directory Access Protocol (LDAP), which provides access to a network address book for scan-to-email and authentication purposes.

The following instructions explain how to use LDAP to connect the printer to a network email address book, and to authenticate users of the printer using their LDAP credentials.

### Email lookup

When the printer uses LDAP it searches a database of email addresses. When you enter the email address and click the **Search** button, LDAP searches a list of email addresses for matching characters. You can refine the search results by typing additional characters and performing a new search.

Printers that support LDAP also support the use of a standard outgoing email profile, so they do not require a connection to an LDAP server in order to send email.

## Information needed before starting

Ensure that you have the following information before starting the configuration:

- Server address (hostname or IP).
- Server authentication requirements.
- Path to start search (BaseDN, Search Root) (for example, `o=mycompany.com`).
- Attributes for matching the name entered (such as `cn` or `samAccountName`), retrieving the email address (such as `mail`), and how the name will be displayed on the control panel (such as `displayName`).

## Address book setup

In the Embedded Web Server, click **Settings >Address book**. Here you can configure the printer to obtain email addresses from an LDAP server, so that they are available when users perform a search.

1. Open the Embedded Web Server.
2. Click **Settings >Address book**.
3. Enable the LDAP server (mandatory to continue with the LDAP configuration).

### Network Directory Server section:

4. In the **Network Directory Server** section, enter the name of the LDAP server address (for example, `ldap.mycompany.com`) and **Port**.

### Server Authentication requirements section:

5. In the **Server authentication requirements** section you can select the appropriate authentication type in the server (Windows credentials, simple credential, use printer user's credentials). It is mandatory to fill the Domain name, Username, and password.

### LDAP Database search settings section:

6. Fill in these fields:
  - In the path to start a search (BaseDN, Search Root) box, enter the path to start searching the database (for example, `o=mycompany.com`).
  - In the recipients's display name box, enter the name of the attribute that contains the person's name (for example, `displayName`).
  - In the recipient's email address box, enter the name of the attribute that contains the person's email address (for example, `mail` or `rfc822Mailbox`).
  - Use the LDAP filter condition box to set up an optional filter to filter out e-mail addresses.
7. Click the **Apply** button to save the settings. Setup is complete.
8. To check that the LDAP retrieval is set up correctly, enter at least three characters of a network contact name in the **Test** box, and then click the **Test** button. If the test is successful a message is displayed.

## Configure a network folder

In the printer's Embedded Web Server, click the **Settings** tab and **Network** folder. See [Embedded Web Server on page 29](#).

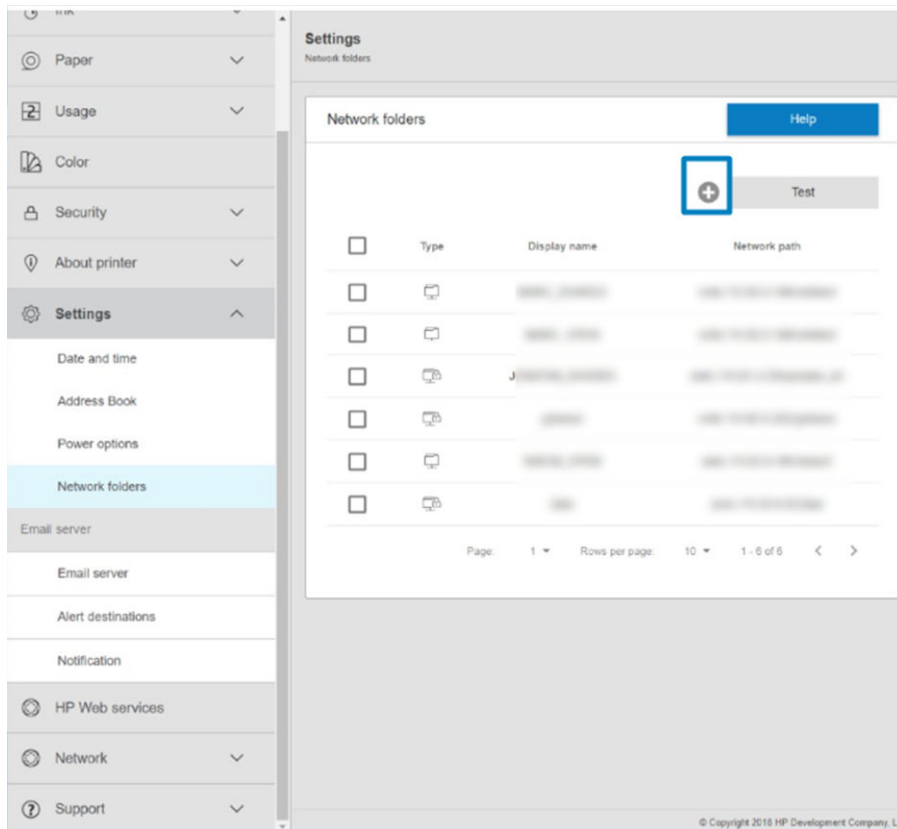

On the Network folders page, click **+** at the top of the page, and fill in the various fields:

- **Display name:** Name displayed in the front panel when you are choosing the file's printing origin.
- **Network path:** Should contain the network name of the remote computer and must start with // followed by the path.
- **Protocol:** SMB
- **Functionality Use:** Choose between **Print only** or **None**.
- **Default Network destination:** Enable this option to configure this folder as the default destination for files.
- **Browse Network folder Structure:** Enable to browse through the structure of folders.
- **Authentication requirements:** Enter the login username and password for the printer to access documents and images in the network folder. The username and password are stored and encrypted in the printer's memory. There are 3 options:
  - **None:** Use this setting for an unprotected folder on the network (no credentials required).
  - **Automatic login using following credentials:** Enter username and password only once during configuration and later use the folder in the front panel without entering credentials.
  - **Prompt for credentials when needed:** Enter username and password in the front panel every time you use it.

---

 **NOTE:** User password should contain the password of the **user**. Domain should contain the name of the domain in which the user name exists. If the **user** does not belong to any domain, leave this field empty.



---

- **Security Pin Option:** Create a 4-digit security PIN to prevent unauthorized people from accessing documents and images in this network folder.

For a network folder, enter the remote computer's name or IP address, the shared folder's, and the username and password of the **user** already created on the remote computer. Leave the user domain field empty unless the user is a member of a Windows domain. If the user is only a local user of the remote computer, leave the field empty. You can use the name (instead of the IP address) in the server name field, only if the shared folder is on a Windows computer in the same local network.

- Click **Apply** to save the configuration.
- The printer automatically checks that it can access the network folder. If not, see [Cannot access the network folder on page 180](#).

---

 **NOTE:** If the product has already been configured for printing from networks and you now want to use a different shared folder, click  .

---

You can check that the shared folder remains accessible by clicking Verify in the Embedded Web Server at any time. A correctly configured shared folder can become inaccessible if the user's password is changed, or if the shared folder is moved or deleted.

#### Example: Create a network folder under Windows

1. Create a new user account on the remote computer. You can use an existing user account for this purpose, but it is not recommended.
2. Create a new folder on the remote computer, unless you want to use an existing folder.
3. Right-click the folder and click **Properties**.

4. In the **Sharing tab**, click the **Advanced Sharing** button.

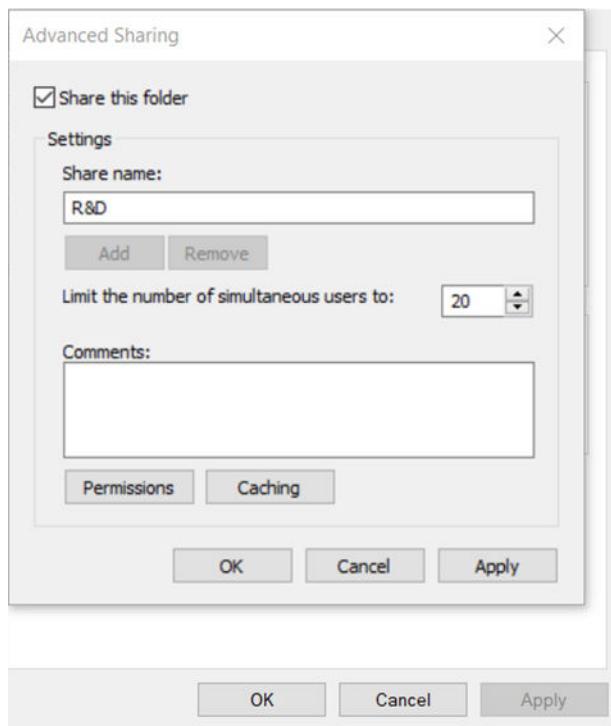
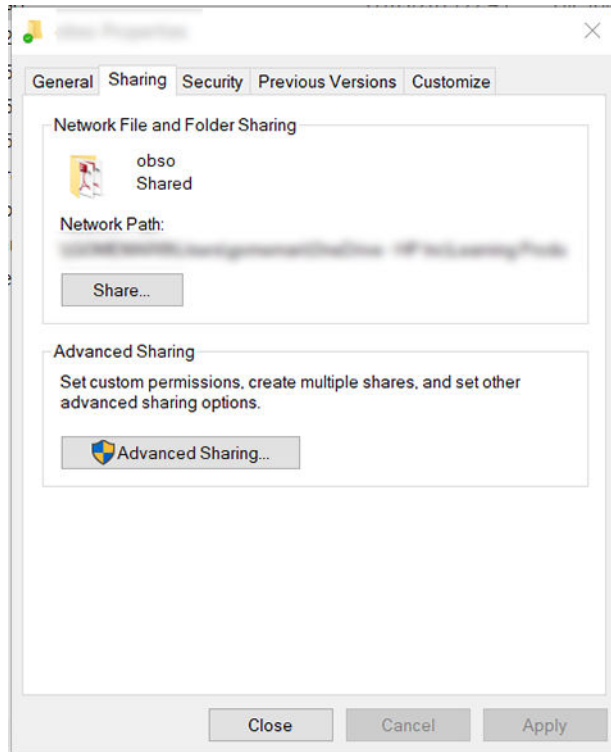

5. Ensure that the **user** has the correct permission settings depending of the functionality use of the network folder.

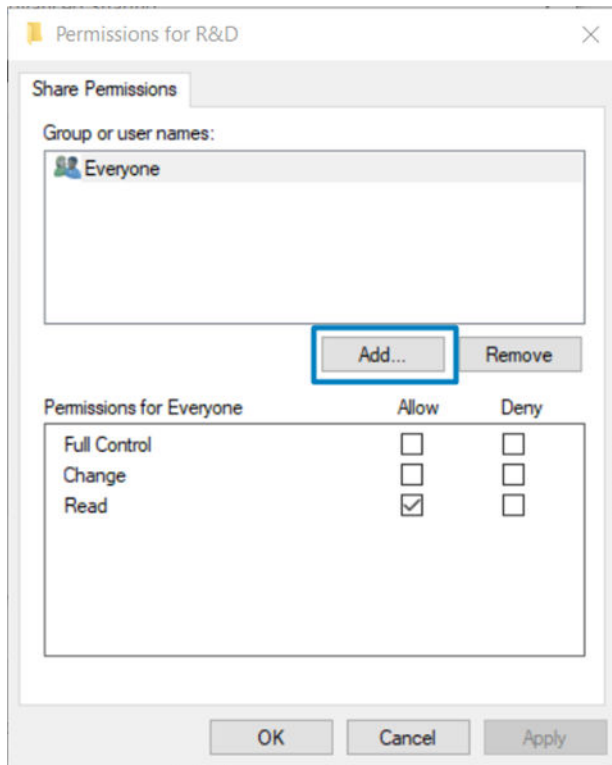

#### Example: Create a network folder under Mac OS

1. Create a new user account for the **User** on the remote computer. You can use an existing user account for this purpose, but it is not recommended.
2. Create or choose a folder on the remote computer. By default, Mac OS users have a Public folder that can easily be used for this purpose.

3. Open the **System Preferences** application and click the **Sharing** icon.

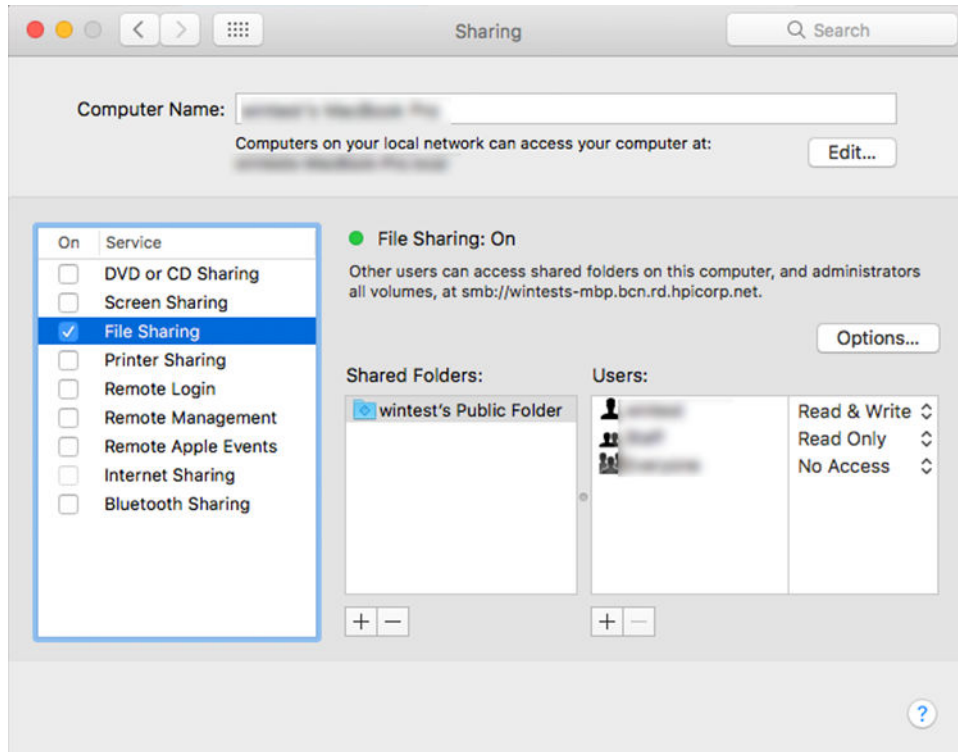

4. Depending of the functionality of the folder, make sure the user has the right permissions.
5. Click **Options**.

6. Check the **Share files and folder using the SMB** box, and make sure that the **User** is checked in the **On** column.

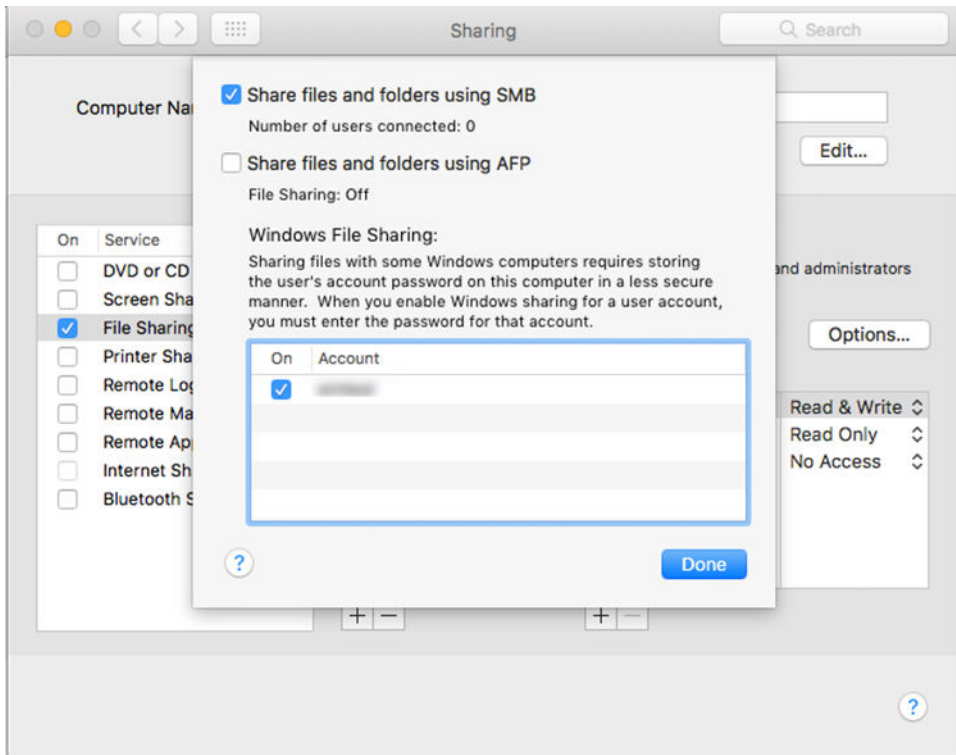

7. Click **Done**. You can now see file sharing enabled and Windows sharing on.

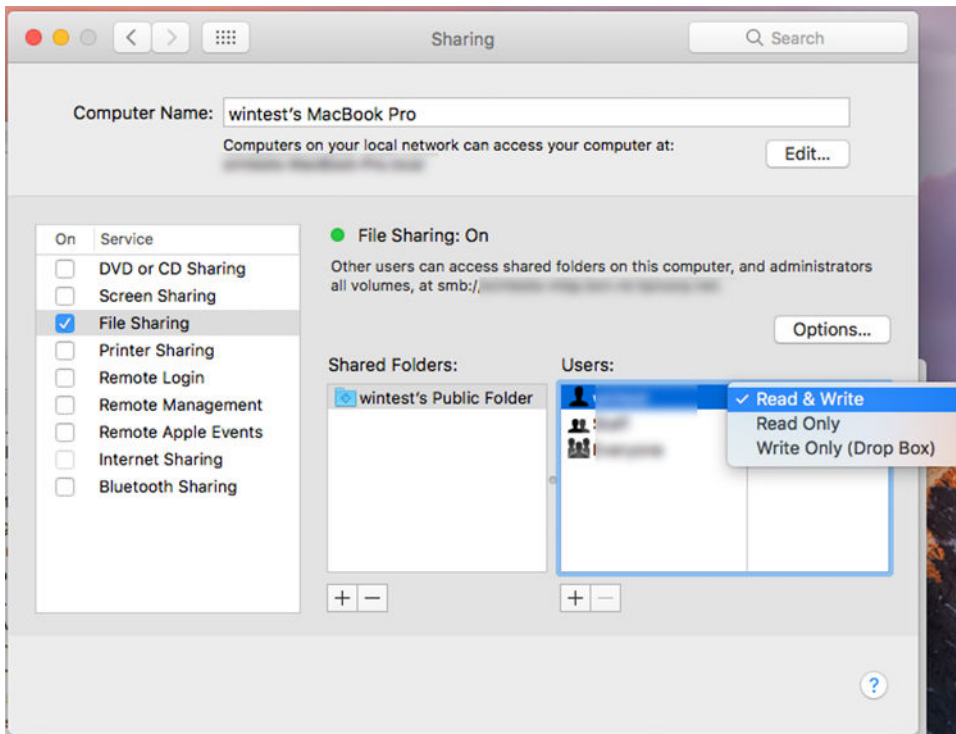



## Control access to the printer

### Manage printer security with HP Connected

When you have set up Web Services, the printer is in unlock mode. In unlock mode, anyone who knows your printer's email address can print to your printer just by sending a file to it. Although HP provides a spam filtering service, you should be careful about giving out your printer's email address, as everything sent to that address may be printed on your printer.

If you are the printer administrator, you can manage printer security or change your printer status to lock mode by visiting HP Connected at <http://www.hpconnected.com>. You can also customize your printer's email address and manage print jobs from there. At your first visit, you will need to create an account at HP Connected using the printer's code.

### Embedded Web Server security settings

From the Embedded Web Server menu, you can click **Security** and then **Administrator password** to control access to the printer by specifying an administrator account to control access to the Embedded Web Server and the printer's front panel.

The administrator can also define other types of permissions in the control panel through the **Access control** menu option. In this section, the administrator can create new printer user accounts and assign them specific permissions depending on their role.

Other security settings are available under the **Security settings** menu option, which apply to all users.

## LDAP – sign-in server

### Information needed before starting

Ensure that you have the following information before starting the configuration:

- Server address (hostname or IP).
- Server authentication requirements.
- Path to start search (BaseDN, Search Root) (for example, `o=mycompany.com`).
- Attributes for matching the name entered (such as `cn` or `samAccountName`), retrieving the email address (such as `mail`), and how the name will be displayed on the control panel (such as `displayName`).

### Setup

In the Embedded Web Server, click **Settings** > **LDAP sign-in server**.

1. Enable the LDAP server (mandatory to continue with the LDAP configuration).

#### Network Directory Server section:

2. In the **Network Directory Server** section, enter the name of the LDAP server address (for example, `ldap.mycompany.com`) and **Port**.

- If you do not know the LDAP server, contact the server administrator.
- If you want to enable a secure (SSL) connection, enable the toggle **Use a secure connection (SSL)**.

#### Server Authentication requirements section:

3. In the **Server authentication requirements** section you can select the appropriate authentication type in the server (use printer user's credentials, use LDAP administrator's credentials). It is mandatory to fill the Domain name, Username, and password.

**LDAP Database search settings section:**

4. Fill in these fields:
  - In the **Bind and search root** enter the path to start searching the database (for example, `o=mycompany.com`).
  - In the **Retrieve the printer User's Name using this attribute** box enter the name of the attribute that contains the person's name (for example, `displayName`).
  - In the **Match the name entered with this attribute** box enter the name of the attribute which its content should be matched with the username type during sign-in.
  - In the **Retrieve the Users Email Address using this attribute** box, enter the name of the attribute that contains the person's email address (for example, `mail` or `rfc822Mailbox`).
  - In the **Retrieve the printer user group using this attribute** box enter the name of the attribute that contains the groups the person belongs to.
5. Click the **Apply** button to save the settings. Setup is complete.
6. To check that the LDAP retrieval is set up correctly, enter at least three characters of a network contact name in the **Test** box, and then click the **Test** button. If the test is successful a message is displayed.

## Front-panel security settings

From the front panel, you can tap , then **Security**, to control some of the features of the printer:

- **User sessions:** Enable or disable automatic log-out after 1, 3, or 5 minutes.
- **Embedded Web Server:** Enable or disable the Embedded Web Server.
- **Printing & management Web services:** Enable or disable Web services that are used by printing and management tools such as the HP Utility, HP Click, and SDK for RIPs.

If an administrator password has been set, it must be given in order to perform the following operations:

- Change the security settings (including the administrator password itself).
- Change the configuration of the Internet connection.
- Change the Automatic Firmware Update configuration.
- Enable or disable automatic downloading and/or installation of automatic firmware updates.
- Restore an earlier firmware version.
- Reset factory defaults.



**NOTE:** The administrator password can contain only characters that appear on the front panel's on-screen keyboard. If you set a new password with the Embedded Web Server, it will reject characters that do not appear in that limited character set.

## Require account ID

If you want to keep records of printer usage by different users, you can set your printer to require an account ID for each job. At the front panel, tap , then **Job management** > **Account ID required**.

If this setting is turned on, the account ID field will be mandatory and jobs with no account ID will be kept "on hold for accounting".

The account ID can be set in the printer driver when sending the job. If the job is set "on hold for accounting" by the printer, you can introduce the account ID in the driver or front panel, by going to the job queue and clicking the job that is on hold. A window with a text box is displayed and you can enter the account ID into it.

## Drivers

There are various different drivers for your printer; which is best for you depends on your circumstances:

- Your operating system
- The type of applications from which you print
- The number of printers you have
- The output accessories you have

You may wish to install one or several drivers according to your needs.

You can find the latest driver software at <http://www.hp.com/go/DesignJetT1600/drivers/>.

## Specific Windows drivers

The following driver is recommended:

- Non-PostScript printers: The raster driver
- PostScript printers, with Windows 7 or Windows Server 2008R2: The PostScript driver
- PostScript printers, with Windows 8, Windows Server 2012, or later: The PDF driver

## HP Universal Print Driver configuration tool

To install the HP Designjet Universal Print Driver, go to [www.hp.com/go/DesignJetT1600/support](http://www.hp.com/go/DesignJetT1600/support) and click **Software and drivers** > **Driver - Universal Print Driver** > **Download**. We recommend to select the **HP DesignJet UPD PostScript Driver** if you have a PostScript Printer.

At the end of installation, go to **Printer** > **Device Settings** > **Properties**, and confirm that **Generic** is displayed in **Current model**.

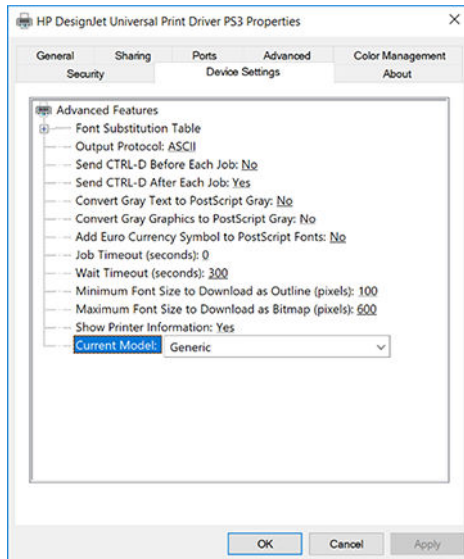

To install the tool, go to <http://www.hp.com/go/DesignJetT1600/support> and click **Software and drivers** > **Software – Utility** > **UPD configuration tool** > **Download**.

For information about how to install and use the tool, go to <https://support.hp.com/us-en/document/c05658213>.

## Set Windows driver preferences

You can change some default settings in your printer driver according to your own preferences, for instance to set color or paper-saving options. To do this, click the Start or Search button on your computer's screen, then click **Devices and Settings** or **Devices and Printers**. In the next window, right-click your printer's icon, and click **Printing Preferences**. Any settings you change in the Printing Preferences window will be saved as default values for the current user.

To set the default values for all users of your system, right-click the printer's icon, click **Printer Properties**, go to the **Advanced** tab, and click **Printing Defaults**. Any settings you change in the printing defaults will be saved for all users.

## Change the graphic language setting

You can change the graphic language setting from the front panel. Tap , then **Default printing configuration** > **Graphics language**.

Then select one of the following options:

- Select **Automatic** to let the printer determine which type of file it is receiving. This is the default setting; it works for most software applications. You should not normally need to change it.
- Select **PS (PostScript)** only if you are sending a file of that type directly to the printer, without going through a printer driver.
- Select **PDF** only if you are sending a file of that type directly to the printer, without going through a printer driver.
- Select **HP-GL/2** only if you are sending a file of that type directly to the printer, without going through a printer driver.

- Select **CALS/G4** only if you are sending a file of that type directly to the printer, without going through a printer driver.
- Select **TIFF** only if you are sending a file of that type directly to the printer, without going through a printer driver.
- Select **JPEG** only if you are sending a file of that type directly to the printer, without going through a printer driver.

## Mobile printing

With HP Mobile Printing Solutions you can print straight from your smartphone or tablet in just a few simple steps wherever you are; using your mobile device OS or sending an email to your printer with PDF, TIFF, or JPEG attachments.

- For Android printing, install the HP Print Service App from Google Play. If you have already installed it, check that it is up to date. You can obtain the latest version from <https://play.google.com/store/apps/details?id=com.hp.android.printservice>.
- You can also download the HP Smart App to enhance your printing capabilities from a smartphone or tablet.
  - Latest iOS version from <https://itunes.apple.com/app/id469284907>
  - Latest Android version from <https://play.google.com/store/apps/details?id=com.hp.printercontrol>
- To enable email printing, ensure that the service is enabled, and retrieve the printer's email address from the front panel.

For more detailed information, see <http://www.hp.com/go/designjetmobility>.

## Accessibility

### Front panel

If required, the front-panel display brightness and the loudspeaker volume can be changed (see [Change system options on page 11](#)).

### Embedded Web Server

From the Embedded Web Server, you can see the status of the printer, and perform other actions without using the front panel.

For information about the accessibility features of the Embedded Web Server, click **Support > Accessibility**.

**Accessibility**  
See accessibility features

**Accessibility**

Refresh rate (seconds): 5

List of area access keys

Area	Access key combination
Header	ALT + 1
Menu	ALT + 2
Content	ALT + 3
Move through elements	TAB

Note: Keyboard shortcuts are supported under Windows and Mac OS

See <http://www.hp.com/hpinfo/abouthp/accessibility/> for information about the HP Accessibility Program, and HP's commitment to making its products and services accessible to people with disabilities.

## Other sources of information

The following documents can be downloaded from [www.hp.com/go/DesignJetT1600/manuals](http://www.hp.com/go/DesignJetT1600/manuals):

- Introductory information
- User guide
- Legal information
- Limited warranty

---

## 2 Paper handling

- [General advice](#)
- [Load a roll onto the spindle](#)
- [Load a roll into the printer](#)
- [Unload a roll](#)
- [Load a single sheet](#)
- [The stacker](#)
- [The basket](#)
- [View information about the paper](#)
- [Paper presets](#)
- [Printing paper info](#)
- [Move the paper](#)
- [Maintain paper](#)
- [Change the drying time](#)
- [Turn the automatic cutter on and off](#)
- [Clean cut](#)

## General advice

**⚠ CAUTION:** Before starting a paper loading process, ensure that you have enough room around the printer, both in front and behind. You need at least enough space behind the printer to open the basket fully.

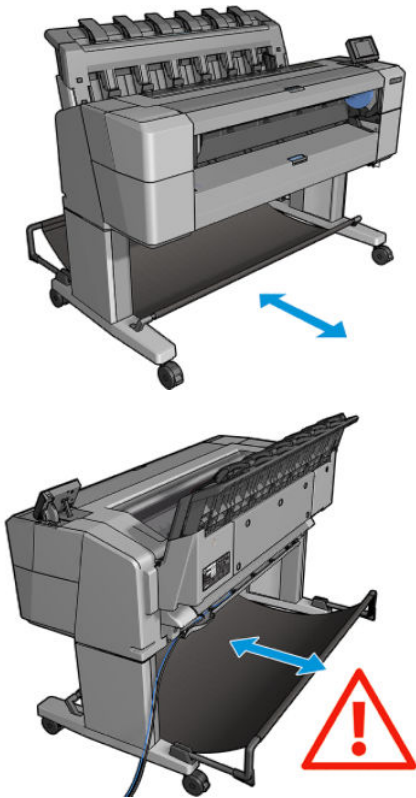

**⚠ CAUTION:** Ensure that the printer wheels are locked (the brake lever is pressed down) to prevent the printer from moving.

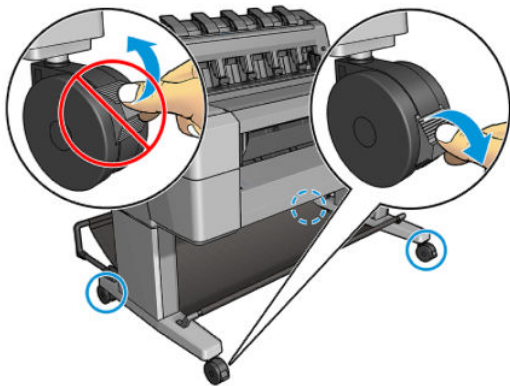

**⚠ CAUTION:** All paper must be 279 mm (11 in) or longer. A4 and letter paper cannot be loaded in landscape orientation.

**💡 TIP:** For photo paper wear cotton gloves to avoid transferring oils onto the paper.



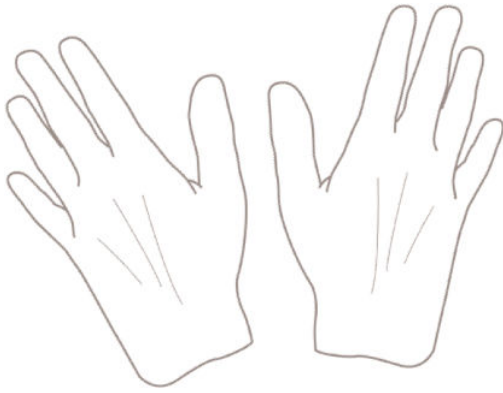

## Load a roll onto the spindle

1. Open the roll cover.

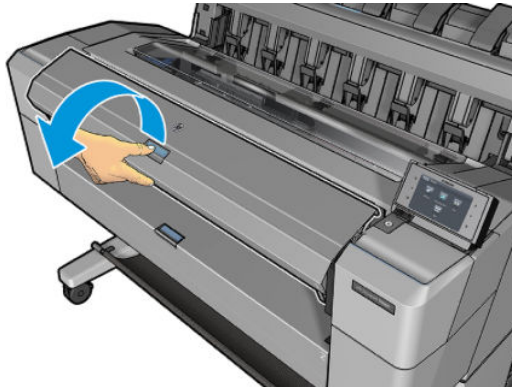

2. Remove the black end of the spindle from the printer, then the blue end.

**⚠ CAUTION:** Be sure to remove the black end first. Removing the blue end first could damage the black end.

**⚠ WARNING!** Do not insert your fingers into the spindle supports during the removal process.

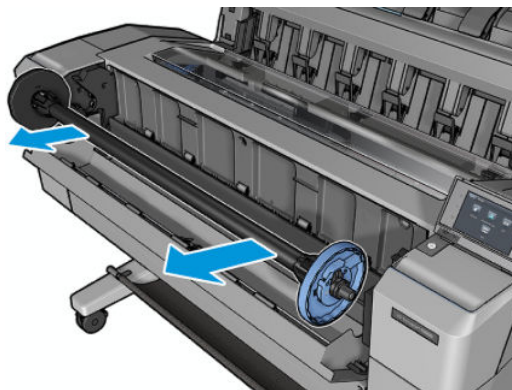

3. The spindle has a stop at each end. The blue stop can move along the spindle and has a latch to lock it in place. Open the latch and remove the blue stop from the end of the spindle.

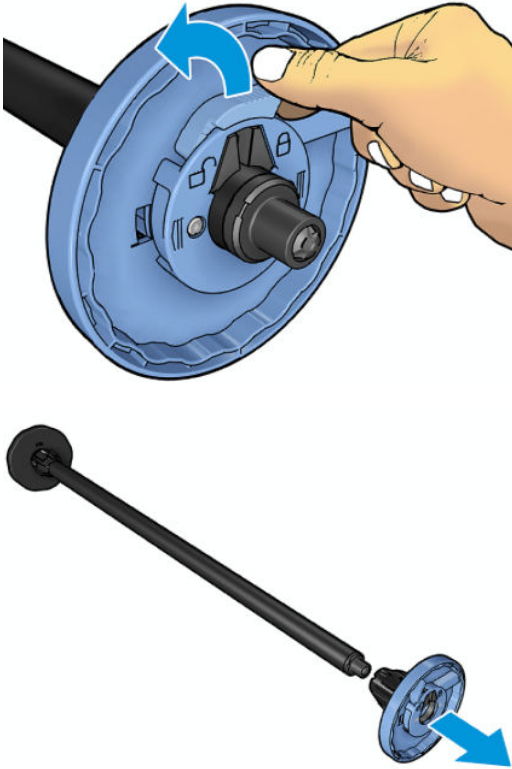

4. If there is already a roll or core on the spindle, remove it.
5. If the roll is long, rest it horizontally on a table and insert the spindle into it.

 **TIP:** You may need two people to handle a large roll.

6. Slide the new roll onto the spindle. Make sure the paper type is oriented as shown. If it is not, remove the roll, turn it 180 degrees and slide it back on to the spindle. There are labels on the spindle showing the correct orientation.

 **NOTE:** From the front of the printer, the blue stop should be inserted into the right-side holder.

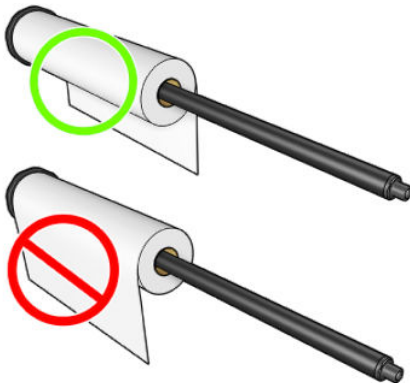

- Put the blue stop onto the open end of the spindle, and push it towards the end of the roll.

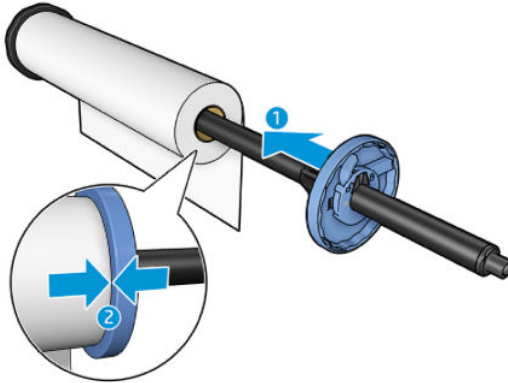

- Ensure that the blue stop is pushed in as far as it goes; until both ends are against the stops, then close the latch.

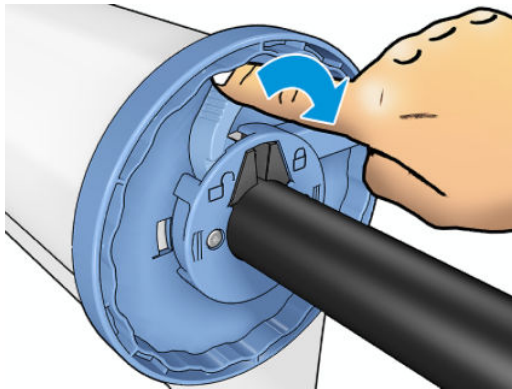

If you are a regular user of different paper types, you can change rolls more quickly if you preload rolls of different paper types on different spindles. Extra spindles are available for purchase, see [Supplies and accessories on page 137](#).

## Load a roll into the printer

To start this procedure, you must have a roll loaded on the spindle. See [Load a roll onto the spindle on page 33](#).

- TIP:** Do not try to open both roll covers at once; this may cause problems. Always close one cover before opening the other.
- NOTE:** The first two steps below are optional: you can start with step 3. However, in this case the printer will not keep track of the length of the roll, and will print no barcode on the roll when it is next unloaded. So you are recommended to follow all the steps, starting with step 1, unless you have turned off the **Printing paper info** option. See [Printing paper info on page 45](#).

1. From the front panel, press , then the roll icon, then **Load**.

If the roll you have selected is already loaded, you have to wait while it is automatically unloaded.

2. If you start to load roll 1 while roll 2 is already loaded, roll 2 is withdrawn to the standby position, so that it can be printed on again without reloading whenever required (and vice versa).

---

 **NOTE:** If at any time you open a roll cover while that roll is loaded but not printing, the roll will be automatically unloaded, and you will have to reload it the next time you want to print on it.

---

3. Open the roll cover.

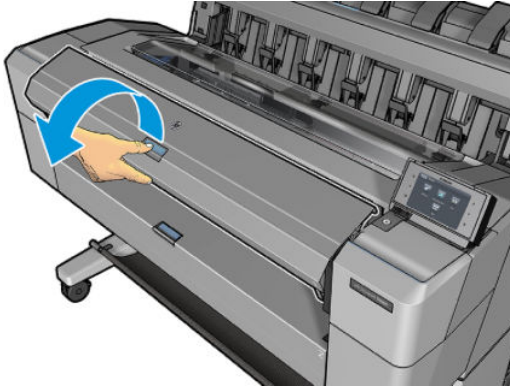

4. Load the spindle into the printer, with the blue stop on the right. Hold the spindle by its ends and not in the middle, to avoid touching the paper and perhaps leaving marks on it.

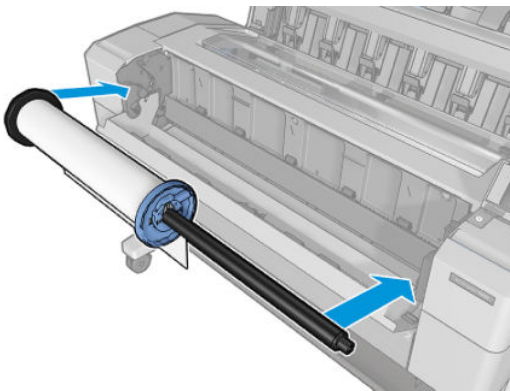

5. If the edge of the roll is not straight or torn (sometimes due to tape used to hold end of the roll), pull the paper slightly and cut a straight edge.

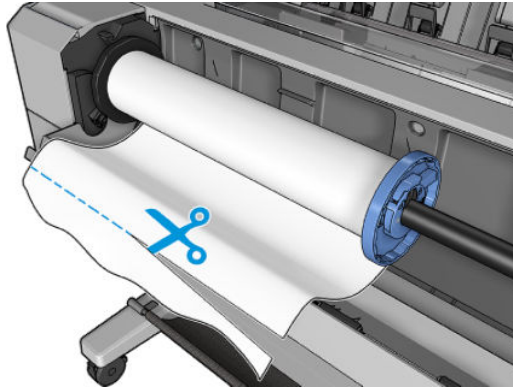

6. Insert the edge of the paper into the printer.

**⚠ WARNING!** Do not push your fingers inside the printer's paper path.

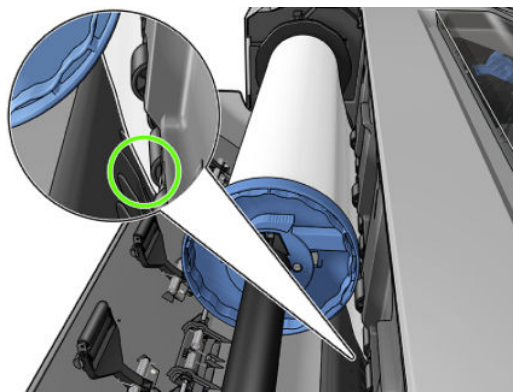
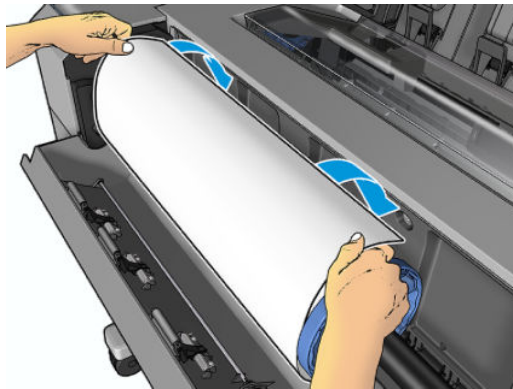

7. Roll the paper into the printer until you feel resistance and the paper flexes slightly. When the printer detects the paper, it feeds it in automatically.

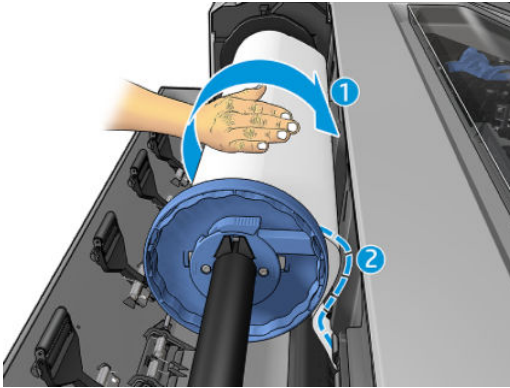

8. If the leading edge of the paper has a barcode, the printer reads and then cuts off the barcode, which falls into the basket.
9. If the leading edge of the paper has no barcode, the front panel prompts you to select the paper category and type.

---

 **TIP:** If you have loaded a paper type whose name does not appear in the paper list, see [Paper type is not in the driver on page 145](#).

---

10. If the **Printing paper info** option is enabled, the front panel may ask you to specify the length of the roll. See [Printing paper info on page 45](#).
11. Close the roll cover when the front panel prompts you to do so.

---

 **NOTE:** If you have an unexpected issue at any stage of the paper loading process, see [Paper cannot be loaded successfully on page 144](#).

---

## Unload a roll

Before unloading a roll, check whether there is paper on the roll or if the roll is out of paper, and follow the appropriate procedure as described below.

### Quick procedure with paper on the roll

If there is paper on the roll, just open the roll cover, and the roll is unloaded automatically. The front panel prompts you to load a new roll or sheet.

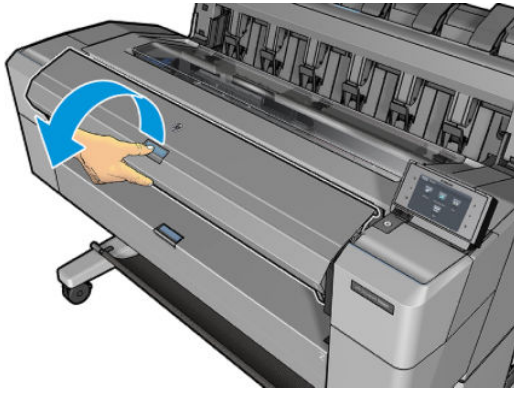

 **NOTE:** When the roll is unloaded in this way, no barcode is printed on it, so the printer will not know the length of the roll when it is next loaded. See [Printing paper info on page 45](#).

 **NOTE:** If you open the a roll cover while a sheet is loaded, the sheet is also unloaded.

## Front panel procedure with paper on the roll

If there is paper on the roll, you can unload it from the front panel.

1. Press , then the roll icon, then **Unload**.
2. You may need to open the roll cover.

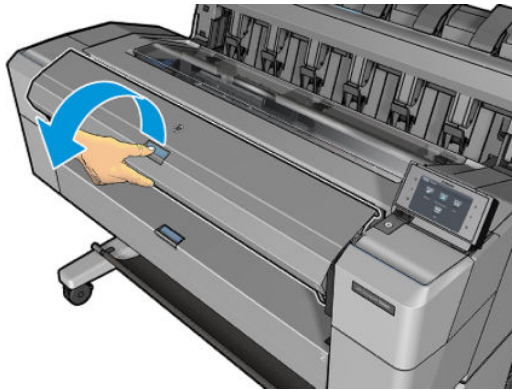

## Load a single sheet

1. Measure sheet length before loading (if it is not standard size).

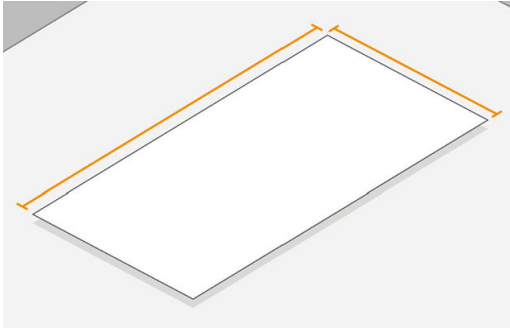

2. Ensure that both roll covers are closed. If a roll cover is opened while a sheet is loaded, the sheet is immediately unloaded.

---

**⚠ WARNING!** Do not load the sheet before starting the loading process from the front panel.

---

3. At the front panel, press , then the sheet icon, then **Load > Load sheet**.
4. If a roll is already loaded, you have to wait while it is automatically withdrawn to the standby position, so that it can be printed on again without reloading as soon as the sheet paper has been unloaded.

---

**📝 NOTE:** If at any time you open a roll cover while that roll is loaded but not printing, the roll will be automatically unloaded, and you will have to reload it the next time you want to print on it.

---

5. Select your paper category and type.

---

**💡 TIP:** If you have loaded a paper type whose name does not appear in the paper list, see [Paper type is not in the driver on page 145](#).

---

6. When prompted by the front panel, insert the sheet into the front of the printer.

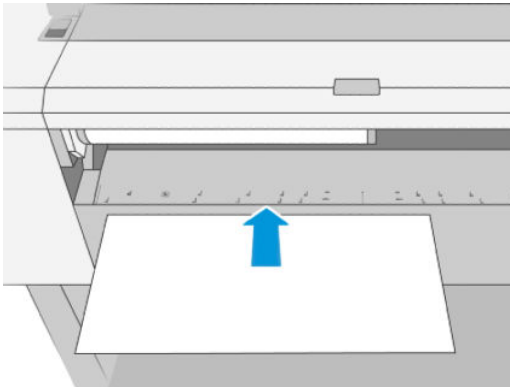



7. Align the left-hand edge of the sheet with the blue line on the left-hand side of the printer.

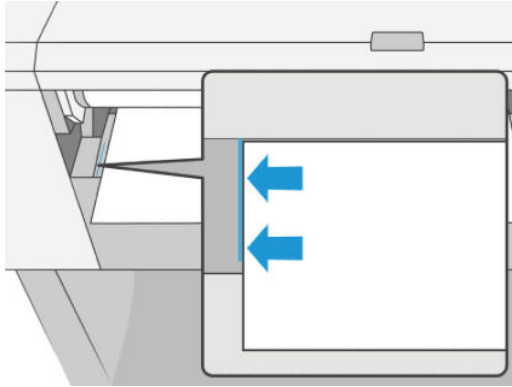

8. Push the sheet into the printer until it will not go any further.

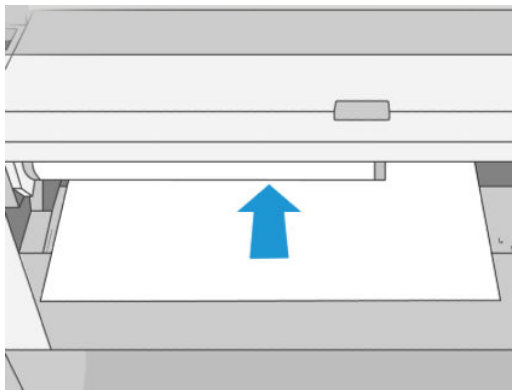

---

**⚠ WARNING!** Do not push your fingers inside the printer's paper path.

---

9. Guide the sheet into the printer until the printer beeps and starts pulling the paper.
10. The printer checks the alignment.
11. If the sheet is not correctly aligned, it is ejected, and you will have to try again.

---

**📝 NOTE:** If you have an unexpected problem at any stage of the paper loading process, see [Paper cannot be loaded successfully on page 144](#).

---

## The stacker

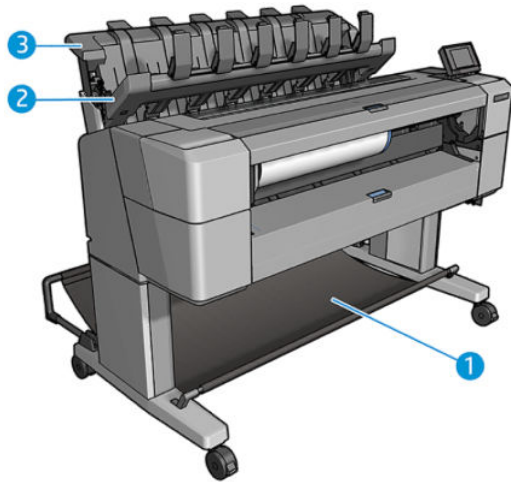

1. Basket
2. Stacker pivoting cover
3. Stacker

By default, the printer cuts the paper after every print job. The resulting printed sheet of paper is neatly stacked on top of the other printed sheets by the stacker.

To empty the stacker, stand in front of the printer and pull the stack of printed sheets out of the stacker. The stacker cover may open during this process; make sure that it is closed after you have removed the sheets. Normally the return spring will close it automatically.

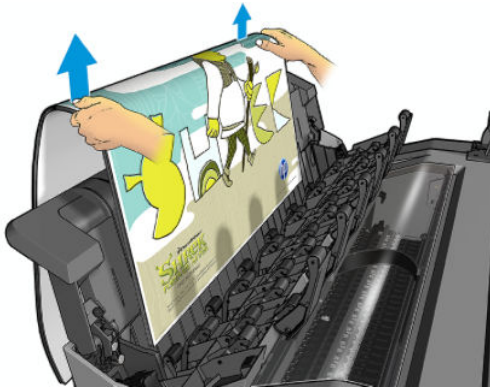

---

**TIP:** Although you can remove sheets from the stacker while the printer is printing, you are recommended to remove all the prints together while the printer is not printing.

**TIP:** You can lock the stacker cover in the open position to collect special jobs. Make sure that you close it afterwards.

**TIP:** If you want to use a photo paper for printing in normal printing mode to the stacker, you are recommended to use an HP Instant-Dry Photo Paper.

---

## Manual printing with the stacker open

The stacker's manual printing mode is designed to be used when you want the highest-quality print possible on photo paper, and you are willing to stand in front of the printer to ensure it.

You can choose attended mode either for a particular job (for example, from the printer driver), or by putting the printer into attended mode from the front panel.

- If you send a job with attended mode selected, the job is put on hold, and other jobs can continue printing, until you select it for printing from the front panel (the front panel can guide you through this process) and open the stacker cover.
- If you put the printer into attended mode from the front panel, all jobs in the queue are put on hold for manual mode, and you can print them from the queue. When you exit manual mode, any jobs still in the queue return to their previous status.

 **NOTE:** When opening the stacker to enter manual mode, lock the stacker cover into the open position.

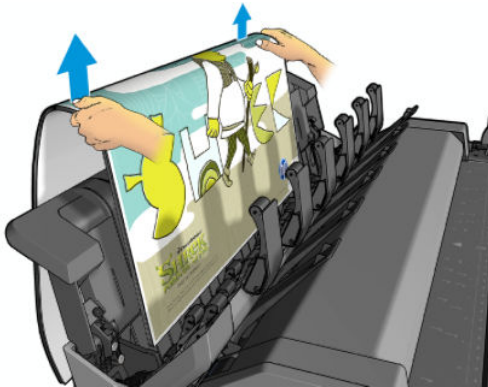
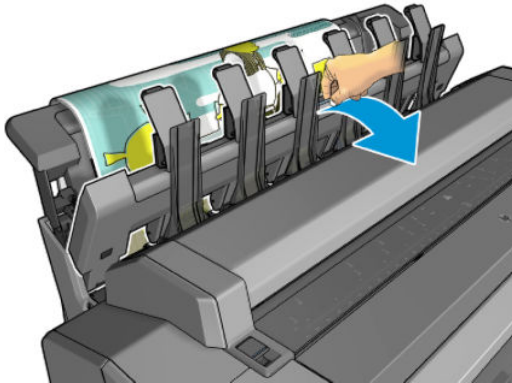

In manual mode:

- You can print only one page at a time. You must start each page manually from the front panel.
- You print with the stacker cover open, and stand in front of the printer to check the print as it emerges.
- With the stacker cover open, you have a better view of the print as it emerges, but the stacker cannot guarantee that the print will follow the correct paper path, so you must watch over it to prevent possible damage.
- If the printer is left idle and in manual mode for more than 15 minutes, manual mode is cancelled, and you are advised to close the stacker.
- You can exit manual mode from the front panel or by closing the stacker.

Manual mode is indicated in various front-panel screens by the  icon.

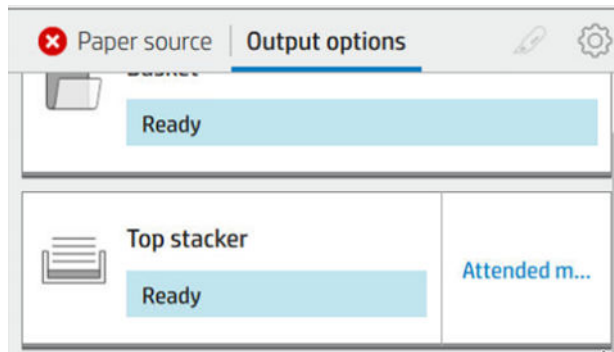

To enter manual mode, on the front panel tap , then **output options > top stacker > attended mode**.

## The basket

The stacker is normally used to collect prints. If you decide not to use the stacker, you can send your prints to the basket. You may decide to use the basket if you do not want to cut paper between print jobs, or if the stacker is full.

The basket can accept up to 10 A1 or D-sized sheets of bond paper. Larger prints should be removed from the basket immediately after printing.

 **TIP:** Ensure that you have routed all cables correctly, so that they do not interfere with paper falling into the basket. Otherwise you may experience paper jams.

## View information about the paper

To view the loaded paper information, press , then the roll icon.

The following information is displayed on the front panel:

- The paper type you have selected
- Roll or sheet status
- Width of the paper in millimeters (estimated)
- Length of the paper in millimeters (estimated)
- Calibration status

The same information is displayed in the HP DesignJet Utility for Windows (**Overview** tab > **Supplies** tab) and the HP Utility for Mac OS X (Information group > **Supplies Status**).

## Paper presets

Each supported paper type has its own characteristics. For optimum print quality, the printer changes the way it prints on each different paper type. For example, some may need more ink and some may require a longer drying time. So the printer must be given a description of the requirements of each paper type. This description is called the *paper preset*. The paper preset contains the ICC profile, which describes the color characteristics of the paper; it also contains information on other characteristics and requirements of the paper that are not directly related to color. Existing paper presets for your printer are already installed in the printer's software.

However, as it is inconvenient to scroll through a list of all paper types available, your printer only contains paper presets for the most commonly used paper types. If you have a paper type for which your printer has no preset, you cannot select that paper type.

There are two ways to assign a preset for a new paper type.

- Use one of the existing HP factory paper presets by selecting the closest category and type in the front panel or the printer driver. See [Paper type is not in the driver on page 145](#).

---

 **NOTE:** Colors may not be accurate. This method is not recommended for high-quality prints.

---

- Download the correct paper preset from: <http://hp.globalbmg.com/paperpresets>.

---

 **NOTE:** HP provides presets for HP paper types only. If you do not find the paper preset you want on the Web, you may find that it has been added to the latest firmware for your printer. You can check the firmware release notes for information, see [Update the firmware on page 134](#).

---

## To install a downloaded paper preset

1. After finding the right paper preset at <http://www.globalbmg.com/hp/en/paperpresets>, or the paper manufacturer's website, click the **Download Now** button and save the paper preset (an **.oms** file) on your computer.

---

 **NOTE:** If you do not find the paper preset you want on the Web, you may find that it has been added to the latest firmware for your printer. You can check the firmware release notes for information, see [Update the firmware on page 134](#).

---

2. Before starting to install the new preset, make sure that the printer is idle and the print queue is stopped. Installing a new paper preset will interrupt any printing that is in progress.
3. Start the HP DesignJet Utility or the Embedded Web Server.
  - In the HP DesignJet Utility for Windows, select the **Color Center** and then **Import Paper Preset**.
  - In the Embedded Web Server, click the **Paper** tab. In the Paper Management section, click the **Import Paper Preset** tab.
4. On the Import page, select the paper preset file that you downloaded in step 1.
5. Click the **Import** button and wait for the update process to finish. It may take some time.
6. Check that the new paper type appears in the **Additional paper** or **Custom paper** category in your printer's front panel.

Now that you have imported the paper preset, you can select the paper type from the front panel and from the driver. The ICC profile for the new paper type is ready to use by your application.

## Printing paper info

Enable the **Printing paper info** option to record the printer's estimate of the remaining roll length, paper width and type. The information is a combination of barcode and text that is printed on the leading edge of the roll when the paper is unloaded from the printer.

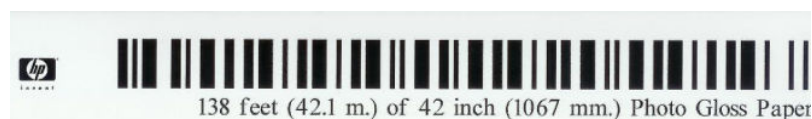

---

 **NOTE:** The paper-length estimate is available only if the printer registered the amount of paper that was on the roll when you loaded it. To provide this information to the printer, specify the roll length on the front panel when loading the paper, or load a roll that has the paper-data barcode printed on it.

 **NOTE:** The barcode and text are printed on the roll only when the loading and unloading processes are started from the front panel's Paper menu.

 **NOTE:** This option can be expected to work only with papers that are completely opaque. It may fail with transparent or translucent papers.

---

To enable the **Printing paper info** option, go to the front panel and press , then **Paper source > Printing paper info > Enable**.

 **NOTE:** Enabling this option slightly changes the paper loading and unloading procedures.

---

## Move the paper

If the printer is idle (ready to print), you can move the paper forwards or backwards from the front panel. You may want to do this in order to have more or less white space between the last print and the next one when the cutter is disabled; or to increase top margin of the next print.

To move the paper, press , then **Paper source > Move paper**.

## Maintain paper

To maintain paper quality, follow the recommendations below.

- Store rolls covered by another piece of paper or cloth
- Store cut sheets covered and clean or brush them before loading them in the printer
- Clean input and output platens
- Always keep the window of your printer closed

 **NOTE:** Photo and coated paper requires careful handling, see [Print is scuffed or scratched on page 160](#).

---

## Change the drying time

You may wish to change the drying time setting to suit special printing conditions such as multiple prints where time is of higher importance or when you need to be sure ink is dry before handling.

Press , then **Default printing configuration > Print retrieval > Drying time**. You can select:

- **Extended**, to set a longer than recommended time to ensure ink is completely dry
- **Optimal**, to set the default and recommended time for your selected paper (this is the default setting)
- **Reduced**, to set a shorter than recommended time when quality is of lower importance
- **None**, to disable the drying time and remove your print as soon as it finishes printing

 **CAUTION:** If the ink is not dry when the print is removed it could leave ink in the output tray and marks on the print.

---

 **NOTE:** If you cancel the drying time during a print, the printer may not feed and cut the paper right away due to the printhead maintenance, which runs in parallel. If the dry time is zero, the printer cuts the paper and then performs the printhead maintenance. However, if the dry time is greater than zero, the printer does not cut the paper until after the printhead maintenance has completed.

---

## Turn the automatic cutter on and off

To turn the printer's paper cutter on or off:

- From the front panel, press , then **Default printing configuration > Cutter > Horizontal cutter**.

The default setting is **On**.

If the cutter is turned off, it does not cut the paper between jobs, but continues to cut the paper on loading, unloading, switching between rolls, and switching between the stacker and the basket.

 **TIP:** To cut roll paper while the automatic cutter is disabled, see [Clean cut on page 47](#).

---

## Clean cut

If you go to the front panel and tap the cutter icon at the top of the page, the printer advances the paper and makes a straight cut across the front edge. There are several possible reasons why you might want to do this.

- To trim the leading edge of the paper if it is damaged or not straight. The cut strip falls into the basket.
- To feed and cut the paper when the automatic cutter has been disabled.
- To cancel the waiting time and print the available pages immediately, if the printer is waiting to nest more pages.

 **NOTE:** The printhead is serviced after each print, and the paper cannot be cut until the process completes, so you may notice a delay.

 **NOTE:** Photo and coated paper requires careful handling, see [Print is scuffed or scratched on page 160](#).

 **TIP:** To move the paper without cutting it, see [Move the paper on page 46](#).

---

---

## 3 Working with two rolls (T1600dr only)

- [Advantages of a multiroll printer](#)
- [How the printer allocates jobs to paper rolls](#)



## Advantages of a multiroll printer

A multiroll printer can be useful in several different ways:

- The printer can automatically switch between different paper types according to your needs.
- The printer can automatically switch between different paper widths according to your needs. This enables you to save paper by printing smaller images on narrower paper.
- If you load two identical rolls into the printer, you can leave it printing unattended for a long time, because it can switch from one roll to the other automatically when the first is exhausted. See [Unattended printing/overnight printing on page 73](#).

The current status of both rolls is shown on the front panel if you tap .

---

 **NOTE:** Bear in mind that a paper type is protected from use unless that paper type is specifically requested. See [Protect a paper type \(T1600dr only\) on page 73](#).

 **NOTE:** If you use a paper not supported by your printer, you may find that automatic switching is disabled, in which case jobs sent to the standby roll are put on hold until the roll is manually unloaded.

 **NOTE:** When you print from a USB flash drive, multiroll printing is considerably simplified: either you specify manually which roll you want to use, or you can select **Save paper**, in which case the printer chooses the narrowest roll on which the print will fit. You cannot specify the paper type.

---

## How the printer allocates jobs to paper rolls

When you submit a print job from the printer driver, you can specify (using the **Paper type** or **Type is** option) that you want it to be printed on a particular paper type; you can even specify (using the **Paper source**, **Source is** or **Paper Feed** option) that you want it to be printed on a particular roll (1 or 2). The printer will try to satisfy these requirements, and it will also look for a paper roll large enough to print the image without clipping.

- If both rolls are suitable for the job, the roll will be chosen according to the roll switching policy. See [Roll policies on page 81](#).
- If just one of the rolls is suitable for the job, it will be printed on that roll.
- If neither roll is suitable for the job, it will be put on hold for paper, or printed on an unsuitable roll, depending on the paper mismatch action. See [Solve paper mismatch on page 82](#).

The printer driver for Windows will tell you which paper types and widths are currently loaded in the printer, and on which rolls.

Here are some settings that may be used in typical situations.

---

 **NOTE:** The **Paper** settings are in the printer driver; the **Roll switching policy** is set in the front panel.

---

- With different paper types loaded:
  - **Paper types:** select the paper type you require
  - **Paper source:** Use printer settings
  - **Roll switching policy:** doesn't matter
- With different paper widths loaded:

- **Paper type:** Use printer settings
- **Paper source:** Use printer settings
- **Roll switching policy:** Minimize paper waste

---

 **TIP:** You can also save paper in some cases by rotating or nesting your images. See [Use paper economically on page 70](#).

---

- With identical rolls loaded:
  - **Paper type:** Use printer settings
  - **Paper source:** Use printer settings
  - **Roll switching policy:** Minimize roll changes

---

# 4 Networking

- [Introduction](#)
- [Control network protocols](#)
- [Front-panel menu items](#)
- [Link configuration methods](#)
- [Troubleshooting](#)

## Introduction

The printer provides a single RJ-45 connector port for a network connection. In order to meet Class B limits, the use of shielded I/O cables is required.

The embedded Jetdirect print server supports connection to IEEE 802.3 10Base-T Ethernet, IEEE 802.3u 100Base-TX Fast Ethernet and 802.3ab 1000Base-T Gigabit Ethernet compliant networks. When connected and powered on, the printer auto-negotiates with your network to operate with a link speed of 10, 100, or 1000 Mbps, and to communicate using full- or half-duplex mode. However, you can manually configure the link using the printer's front panel, or through other configuration tools once network communication is established.

The printer can support multiple network protocols simultaneously, including TCP/IPv4 and TCP/IPv6. For security, it includes features to control IP traffic to and from the printer and supports configuration of IP Security (IPsec) protocols.

## Control network protocols

The printer can simultaneously support multiple network communication protocols. This allows network computers that may be using different protocols to communicate with the same printer.

Each protocol may require some configuration before the printer can communicate on the network. For some protocols, required parameters are automatically sensed and user-specified settings are not needed. However, for other protocols, there may be many parameters to configure.



## Enable or disable network protocols

If a network protocol is enabled, the printer may actively transmit on the network even when there are no computers on the network that use the protocol. This may increase network traffic. To eliminate unnecessary traffic, you can disable unused protocols. Disabling unused protocols lets you:

- Reduce network traffic by eliminating broadcast messages from unused protocols
- Provide better control over who prints to the printer by eliminating users from other networks who might route print jobs to this printer
- Display protocol-specific error conditions for enabled protocols only

To disable unused protocols through the device's control panel menu, see [Front-panel menu items on page 52](#). More detailed control of network protocols is available in the printer's Embedded Web Server, in the **Networking** section web pages. For other tools, such as system command access to the embedded Telnet server, see the *HP Jetdirect Print Server Administrator's Guide* for your print server model.

## Front-panel menu items

To access the printer network configuration settings, go to the front panel and tap , then , then **Network** > **Gigabit Ethernet** > **Modify Configuration**.

Menu item	Sub-menu item	Sub-menu item	Values and description
Information	Print Sec Report		Yes: Prints a report. No (default): Does not print a report.

Menu item	Sub-menu item	Sub-menu item	Values and description
TCP/IP	Host Name		An alphanumeric string, up to 32 characters, used to identify the device. This name is listed on the HP Jetdirect configuration page. The default host name is NPIxxxxxx, where xxxxxx is the last six digits of the LAN hardware (MAC) address.
		IPV4 Settings	Config Method
		DHCP Release	This menu appears if <a href="#">Config Method</a> was set to <a href="#">DHCP</a> and a DHCP lease for the print server exists.  <b>No (default):</b> The current DHCP lease is saved.  <b>Yes:</b> The current DHCP lease and the leased IP address are released.
		DHCP Renew	This menu appears if <a href="#">Config Method</a> was set to <a href="#">DHCP</a> and a DHCP lease for the print server exists.  <b>No (default):</b> The print server does not request to renew the DHCP lease.  <b>Yes:</b> The print server requests to renew the current DHCP lease.
		Manual Settings	(Available only if <a href="#">Config Method</a> is set to <a href="#">Manual</a> ) Configure parameters directly from the printer control panel:  <b>IP Address:</b> The unique IP address of the printer (n.n.n.n).  <b>Subnet Mask:</b> The subnet mask for the printer (n.n.n.n).  <b>Syslog Server:</b> The IP address of the syslog server (n.n.n.n) used to receive and log syslog messages.  <b>Default Gateway:</b> The IP address (n.n.n.n) of the gateway or router used for communications with other networks.  <b>Idle Timeout:</b> The time period, in seconds, after which an idle TCP print data connection is closed (default is 270 seconds, 0 disables the timeout).
		Default IP	Specify the IP address to default to when the print server is unable to obtain an IP address from the network during a forced TCP/IP reconfiguration (for example, when manually configured to use BootP or DHCP).  <b>Auto IP:</b> A link-local IP address 169.254.x.x is set.  <b>Legacy:</b> The address 192.0.0.192 is set, consistent with older HP Jetdirect devices.
		Primary DNS	Specify the IP address (n.n.n.n) of a Primary DNS Server.  <b>NOTE:</b> This item appears only if <a href="#">Manual</a> configuration is a higher priority than <a href="#">DHCP</a> in the <b>Config. Precedence</b> table, configured through the embedded Web server.
		Secondary DNS	Specify the IP address (n.n.n.n) of a Secondary Domain Name System (DNS) Server.  <b>NOTE:</b> This item will appear only if <a href="#">Manual</a> configuration is a higher priority than <a href="#">DHCP</a> in the <b>Config. Precedence</b> table, configured through the embedded Web server.

Menu item	Sub-menu item	Sub-menu item	Values and description
	IPv6 Settings	Enable	Use this item to enable or disable IPv6 operation on the print server.  Off: IPv6 is disabled.  On (default): IPv6 is enabled.
		Address	Use this item to manually configure an IPv6 address.  Manual Settings: Use the <a href="#">Manual Settings</a> menu to enable and manually configure a TCP/ IPv6 address.  Enable: Select this item and choose <a href="#">On</a> to enable manual configuration, or <a href="#">Off</a> to disable manual configuration.  Address: Use this item to type a 32 hexadecimal digit IPv6 node address that uses the colon hexadecimal syntax.
		DHCPv6 Policy	<a href="#">Router Specified</a> : The stateful auto-configuration method to be used by the print server is determined by a router. The router specifies whether the print server obtains its address, its configuration information, or both from a DHCPv6 server.  <a href="#">Router Unavailable</a> : If a router is not available, the print server should attempt to obtain its stateful configuration from a DHCPv6 server.  <a href="#">Always</a> : Whether or not a router is available, the print server always attempts to obtain its stateful configuration from a DHCPv6 server.
		Primary DNS	Use this item to specify an IPv6 address for a primary DNS server that the print server should use.  <b>NOTE:</b> This item will appear only if <a href="#">Manual</a> configuration is a higher priority than <a href="#">DHCP</a> in the <a href="#">Config Precedence</a> table, configured through the embedded Web server.
		Secondary DNS	Use this item to specify an IPv6 address for a secondary DNS server that the print server should use.  <b>NOTE:</b> This item will appear only if <a href="#">Manual</a> configuration is a higher priority than <a href="#">DHCP</a> in the <a href="#">Config Precedence</a> table, configured through the embedded Web server.
	Proxy Server		Specifies the proxy server to be used by embedded applications in the device. A proxy server is typically used by network clients for Internet access. It caches Web pages, and provides a degree of Internet security, for those clients.  To specify a proxy server, enter its IPv4 address or fully-qualified domain name. The name can be up to 255 octets.  For some networks, you may need to contact your Independent Service Provider (ISP) for the proxy server address.
		Proxy Port	Type the port number used by the proxy server for client support. The port number identifies the port reserved for proxy activity on your network, and can be a value from 0 to 65535.
Security	Print Sec Page		<a href="#">Yes</a> : Prints a page that contains the current IPsec security settings on the HP Jetdirect print server.  <a href="#">No</a> (default): A security settings page is not printed.

Menu item	Sub-menu item	Sub-menu item	Values and description
	Secure Web		<p>For configuration management, specify whether the embedded Web server will accept communications using HTTPS (Secure HTTP) only, or both HTTP and HTTPS.</p> <p><b>HTTPS Required:</b> For secure, encrypted communications, only HTTPS access is accepted. The print server will appear as a secure site.</p> <p><b>HTTP/HTTPS optional:</b> Access using either HTTP or HTTPS is permitted.</p> <p><b>NOTE:</b> The factory default setting depends on the print server model.</p>
	IPSEC		<p>Specify the IPsec or Firewall status on the print server.</p> <p><b>Keep:</b> IPsec/Firewall status remains the same as currently configured.</p> <p><b>Disable:</b> IPsec/Firewall operation on the print server is disabled.</p>
	802.1x		
	Enable Wipe		
Reset Security			<p>Specify whether the current security settings on the print server will be saved or reset to factory defaults.</p> <p><b>No (default):</b> The current security settings are maintained.</p> <p><b>Yes:</b> Security settings are reset to factory defaults.</p>
Link Speed			<p>The link speed and communication mode of the print server must match the network. The available settings depend on the device and installed print server. Select one of the following link configuration settings:</p> <p><b>CAUTION:</b> If you change the link setting, network communications with the print server and network device might be lost.</p> <p><b>Auto (default):</b> The print server uses auto-negotiation to configure itself with the highest link speed and communication mode allowed. If auto-negotiation fails, either 100TX HALF or 10TX HALF is set depending on the detected link speed of the hub/switch port. (A 1000T half-duplex selection is not supported.)</p> <p><b>10T Half:</b> 10 Mbps, half-duplex operation.</p> <p><b>10T Full:</b> 10 Mbps, Full-duplex operation.</p> <p><b>100TX Half:</b> 100 Mbps, half-duplex operation.</p> <p><b>100TX Full:</b> 100 Mbps, full-duplex operation.</p> <p><b>100TX Auto:</b> Limits auto-negotiation to a maximum link speed of 100 Mbps.</p> <p><b>1000TX Full:</b> 1000 Mbps, full-duplex operation.</p>

## Link configuration methods

The printer supports 10, 100, or 1000 Mbps network link speeds using full-duplex or half-duplex communication modes (a 1000T half-duplex selection is not supported). By default, it will attempt to auto-negotiate its link operation with the network.

When connecting to network hubs and switches that do not support auto-negotiation, the printer will configure itself for 10 Mbps or 100 Mbps half-duplex operation. For example, when connected to a non-negotiating 10 Mbps hub, the print server will automatically set itself to operate at 10 Mbps half-duplex.

If the printer is not able to connect to the network through auto-negotiation, you can set the link setting by one of the following methods:

- The front panel
- The Embedded Web Server
- The Telnet interface, through a system command prompt
- Network management tools such as HP Web Jetadmin

## Troubleshooting

### IO Configuration card

The IO Configuration card provides comprehensive print server status. The information provided is an important diagnostic tool, especially if network communication is not available. For a description of messages that may appear on the card, see the *HP Jetdirect Print Servers Administrator's Guide* for your print server model.

For detailed connectivity information, go to the **Connectivity** menu and click **Network card** or **Services card** to see all the information available.

The network card provides details about the network configuration and status. The services card provides information about the state of connections to HP services, such as HP ePrint.

To verify correct operation:

1. On the network card, look for the status message **I/O Card Ready**.
2. If **I/O Card Ready** appears, the print server is operating properly. Proceed to the next section.

If a message other than **I/O Card Ready** appears, try the following:

- a. Turn the printer off and then on again to re-initialize the print server.
- b. Check that the status indicator lights (LEDs) are providing proper status.

See the *HP Jetdirect Print Servers Administrator's Guide* for your print server model to interpret and troubleshoot other messages.

### Reset network parameters

If you accidentally misconfigured the printer's network settings, they can be reset to factory default values by tapping , then , then **Network > Restore connectivity factory settings**.

---

**CAUTION:** A factory-installed HP Jetdirect X.509 certificate will be saved during reset to factory default values. However, a Certificate Authority (CA) certificate that has been installed by the user to validate a network authentication server will not be saved.

---



## Link troubleshooting

The printer has status lights (LEDs) beside the network connector that indicate the link status and network activity.

- When the green light is on, the printer has successfully linked to the network.
- When the yellow light is blinking, there is network transmission activity.

If the printer does not successfully connect to the network:

- Both LEDs will be off.
- The alert **No network cable connected** will appear on the front panel.

If a link failure is indicated, try the following:

1. Check the cable connections at both ends.
2. Consider replacing the cables by known good ones.
3. Consider switching to another network connector in the network switch, hub, or device to which the printer is connected.
4. Manually configure the link setting to match the port configuration of the network hub or switch. For manual configuration methods, see [Link configuration methods on page 55](#). Turn the printer off, then on again, to re-initialize the setting.
5. Print a Connectivity Configuration page and check link settings.

Item	Description
Port Config	<p>If the printer is properly linked, this item has one of the following values:</p> <ul style="list-style-type: none"><li>• <b>10BASE-T HALF</b>: 10 Mbps, half-duplex</li><li>• <b>10BASE-T FULL</b>: 10 Mbps, full-duplex</li><li>• <b>100TX-HALF</b>: 100 Mbps, half-duplex</li><li>• <b>100TX-FULL</b>: 100 Mbps, full-duplex</li><li>• <b>1000TX FULL</b></li></ul> <p>If the printer is not properly linked, one of the following messages will appear:</p> <ul style="list-style-type: none"><li>• <b>UNKNOWN</b>: The printer is in an initialization state.</li><li>• <b>DISCONNECTED</b>: A network connection has not been detected. Check network cables. Reconfigure the link settings, or restart the printer.</li></ul>
Auto Negotiation	<p>Indicates whether auto-negotiation for link configuration is on or off.</p> <ul style="list-style-type: none"><li>• <b>ON</b> (default): The printer will attempt to automatically configure itself onto the network at the proper speed and communication mode.</li><li>• <b>OFF</b>: You must manually configure the link speed and communication mode using the front panel. Your settings must match those of the network for proper operation.</li></ul>

6. In case of doubt or misconfiguration of link settings, reset the network parameters to their factory settings. See [Reset network parameters on page 56](#).

## Communication failures between computer and printer

Some symptoms are:

- The front-panel display does not show the **Received jobs** message when you have sent jobs to the printer.
- Your computer displays an error message when you are trying to print.
- Your computer or printer hangs (stays idle), while communication is taking place.
- Print jobs get stuck in your computer's print spooler.
- Your printed output shows random or inexplicable errors (misplaced lines, partial graphics, and so on).

To solve a communication problem:

- Ensure that you have selected the correct printer when sending your job.
- Ensure that the printer works correctly when printing from other applications.
- If your printer is connected to your computer through any other intermediate devices, such as switch boxes, buffer boxes, cable adapters, or cable converters, try using it when connected directly to your computer.
- Try another network cable.
- Remember that very large prints may take some time to receive, process and print.
- If your printer displays warning or error messages that require action, take the required action before trying to print.

## Cannot access the Embedded Web Server

1. If you have not done so already, read [Embedded Web Server on page 13](#).
2. Make sure that Embedded Web Server functionality is enabled in the printer: from the front panel, tap , then **Security > Connectivity > Embedded Web Server (EWS) > On**.
3. Check the proxy configuration in your Web browser in case it is preventing communication with the printer.
4. Ensure that the printer works correctly when printing or accessed from other applications.
5. If the printer displays warning or error messages that require further action, take the action to resolve the problems.
6. If all else fails, turn the printer off and on again with the power key on the front panel.

## Cannot access the printer from the HP Utility

1. If you have not done so already, read [HP Utility on page 12](#).
2. Make sure your printer is not in sleep mode.
3. Make sure your printer driver is available and working correctly for the HP Utility in Windows.
4. From the front panel, tap , then **Security > Web services > Printing & management**, and make sure that it is enabled. If it is disabled, some parts of the HP Utility may not work properly.

## Print jobs take too much time to be received by the printer

If you send a very large print to the printer, there will normally be some delay before it starts printing. However, if you think you are experiencing abnormally long delays, there are various things you could check:

- Make sure the network cable connected to the printer is rated at least Cat5e.
- Make sure that gigabit-speed networking equipment and cabling interconnects your computer client to the printer.
- Make sure that there are no network link issues. See [Link troubleshooting on page 57](#).
- Take into account that, in network deployments with IPSec security protocols enabled and configured in the printer, network performance may be reduced due to the use of cryptographic algorithms to protect network communications.
- Try resetting the network configuration to its factory settings in order to get default settings that are suitable for most standard network environments. See [Reset network parameters on page 56](#).
- You may also find it helpful to test connecting the computer to the printer directly, using a normal Ethernet (Cat5e or Cat6) cable point-to-point, without passing through an Ethernet switch or router. In this configuration, the printer and the computer should both automatically change their IPv4 addresses to the form 169.254.x.x . In this point-to-point configuration you can discard any issues caused by other network equipment.

---

# 5 Printing

- [Introduction](#)
- [Print from a USB flash drive](#)
- [Print from the network folder](#)
- [Print from a computer using a printer driver](#)
- [Advanced print settings](#)

# Introduction

There are various different ways in which you can choose to print, depending on your circumstances and preferences:

- Print a TIFF, JPEG, HP-GL/2, RTL, PDF, or PostScript file directly from a USB flash drive. See [Print from a USB flash drive on page 61](#).
- Print a TIFF, JPEG, HP-GL/2, or PDF file directly from a computer connected to the printer, using HP Click. See <http://www.hp.com/go/DesignJetclick>.
- Print any kind of file from a computer connected to the printer, using a software application that can open the file, and a printer driver supplied with your printer. See [Print from a computer using a printer driver on page 63](#).
- Print from a smartphone or tablet. See [Mobile printing on page 29](#).
- Print from a network folder. See [Print from the network folder on page 62](#).



## Print from a USB flash drive

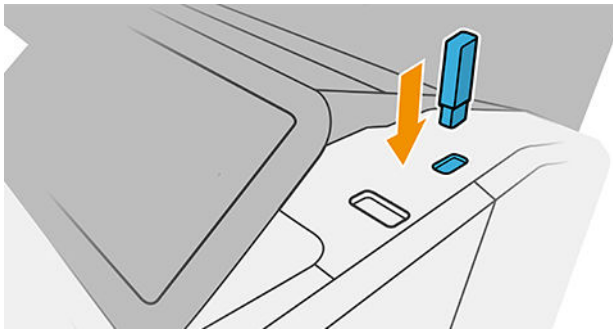

1. Insert a USB flash drive containing one or more TIFF, JPEG, HP-GL/2, RTL, PDF, or PostScript files into the printer's USB port.



 **NOTE:** To print PDF or PostScript file, you must have a PostScript printer.

 **NOTE:** The use of USB flash drives with your printer may be disabled by the administrator.

2. At the front panel, go to the home page and tap .
3. Select . You can tap folders to browse their contents. Files are shown as document thumbnails, and you can preview a file by tapping the preview icon. When the preview is displayed, you can zoom in and out. Files that cannot be printed are indicated with . For more details, press the information button.
4. Select a file to be printed. Multipage documents are supported only in PDF files; in this case, you can also select a page to print.
5. The list of print-from-USB quicksets is displayed. You can choose and/or edit one of the quicksets for the selected job.

 **NOTE:** If you edit a quickset after selecting a job, the changed settings are applied only to the current job and are not saved permanently. You can change any of your own quicksets permanently by tapping  on the quicksets page, or by tapping , then **Quicksets**.

 **NOTE:** The factory quicksets cannot be modified.

---



The following settings are available:

- **Quickset name** allows you to name the quickset you are working with.
  - **Output scale** allows you to resize the print in two different ways: to a percentage of its original size, or to fit a particular paper size. The default is 100% (its original size).
  - **Print quality** allows you to set the print quality to **Fast**, **Normal**, or **Best**.
  - **Color options** allows you to choose color or grayscale.
  - **Paper source** allows you to specify printing on roll 1 or roll 2, or you can choose **Save paper**, which automatically chooses the narrowest roll on which the print will fit (if two rolls are loaded).
  - **Paper category** allows you to choose the type of paper.
  - **Page order** allows you to choose first page on top, or last page on top.
  - **Collate** allows you to turn collation on or off.
  - **Rotation** allows you to rotate the print by any multiple of 90°, or you can choose **Automatic**, which rotates the print automatically if that will save paper.
  - **Alignment** allows you to align the printer to the left, center, or right of the roll.
  - **Printer margins** allows you to change the default printer margins.
  - **Storage mode** offers two options, print and delete (the job is not retained in the job queue) and print and store (the job is retained in the job queue).
6. When you are satisfied with the quickset settings, tap **OK** to continue.
  7. A page with the following settings appears: **Copies**, **Page order**, and **Collate**. You can check and change them in this step, regardless of the settings in the quickset. Tap **Print** to continue.
  8. After printing, you can choose to print another file or go to the job queue. If you print another file immediately without returning to the home page, the temporary settings used for the previous file are used again.

## Print from the network folder

1. Confirm the network folder is configured. See [Configure a network folder on page 19](#).
2. At the front panel, go to the home page and tap .
3. Select **Network**.
4. Select a file to be printed. Multipage documents are only supported in PDF; in this case, you can also select a page to print.
5. The list of print-from-Network quicksets is displayed. You can choose and/or edit one of the quicksets for the selected job.

---

 **NOTE:** If you edit a quickset after selecting a job, the changed settings are applied only to the current job and are not saved permanently. You can change any of your own quicksets permanently by tapping , then **manage quicksets**, or by tapping , then **Quicksets**.

 **NOTE:** The factory quicksets cannot be modified.

---

The following settings are available:

- **Quickset name** allows you to name the quickset you are working with.
  - **Print quality** allows you to set the print quality to **Fast**, **Normal**, or **Best**.
  - **Output scale** allows you to resize the print in two different ways: to a percentage of its original size, or to fit a particular paper size. The default is 100% (its original size).
  - **Color options** allows you to choose color or grayscale.
  - **Paper source** allows you to specify printing on roll 1 or roll 2, or you can choose **Save paper**, which automatically chooses the narrowest roll on which the print will fit (if two rolls are loaded).
  - **Paper category** allows you to choose the type of paper.
  - **Page order** allows you to choose first page on top, or last page on top.
  - **Collate** allows you to turn collation on or off.
  - **Rotation** allows you to rotate the print by any multiple of 90°, or you can choose **Automatic**, which rotates the print automatically if that will save paper.
  - **Print margins** allows you to change the default printer margins.
  - **Storage mode** offers two options, print and delete (the job is not retained in the job queue) and print and store (the job is retained in the job queue).
  - **Output destination**.
6. When you are satisfied with the quickset settings, tap **OK** to continue. You can tap , then **show quickset details panel** to show the most common quickset settings used.
  7. **Copies**, **Page order**, and **Collate** can be selected in the right column of the screen. Tap **Print** to continue.
  8. After printing, you can choose to print another file or go to the job queue. If you print another file immediately without returning to the home page, the temporary settings used for the previous file are used again.

## Print from a computer using a printer driver

This is the traditional way of printing from a computer. The correct printer driver must be installed on the computer (see [Install your printer under Windows on page 15](#)), and the computer must be connected to the printer.

When the printer driver has been installed and the computer is connected to the printer, you can print from a software application by using the application's own **Print** command and selecting the correct printer.

## Advanced print settings

The rest of this chapter explains the various print settings that you can use when printing with a printer driver or the front panel. These methods offer a relatively large number of settings in order to satisfy all requirements.

---

 **TIP:** In general you are recommended to use the default settings unless you know that they do not meet your requirements.

**TIP:** If you intend to reuse a particular group of settings repeatedly, you can save those settings under a name of your own choice and recall them later. A saved group of settings is known as a 'quick set' in the Windows printer driver.

---

## Select print quality

The printer has various print-quality options because best-quality printing requires some loss of speed, while fast printing implies some reduction in print quality.

Therefore, the standard print-quality selector is a slider that allows you to choose between quality and speed. With some paper types, you can choose a compromise position between the two.

Alternatively, you can select from the custom options: **Best**, **Normal** and **Fast**. If you select **Fast**, you can also select **Economode**, which uses a lower rendering resolution and consumes less ink. It therefore increases printing speed even further, but reduces print quality. **Economode** can be selected only from the custom options (not from the slider).

There is also a supplementary custom option that may have an effect on print quality: **Maximum detail**. See [High-quality printing on page 70](#).

---

 **NOTE:** In the Windows driver dialog, the rendering resolution for your job is displayed in the Custom Print Quality Options dialog box (click **Custom options** > **Settings**).

---



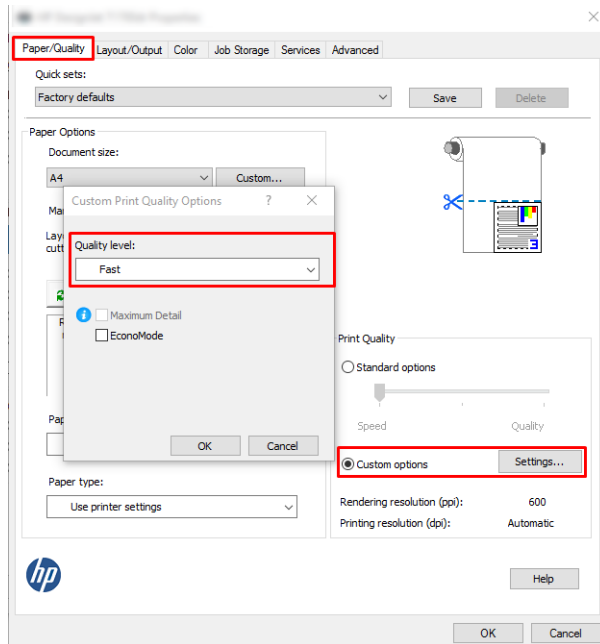

You can select print-quality options in the following ways:

- **In the Windows driver dialog:** Go to the **Paper/Quality** or **Paper** tab (depending on the driver version) and look at the Print Quality section. If you use **Standard Options**, you will see a simple slider with which you can select speed or quality. If you use **Custom Options** or **Advanced**(depending on the driver version), you will see the more specific options described above.



- **Using the front panel:** Tap , then **Default printing configuration > Print quality**.

 **NOTE:** If the print quality is set from your computer, it overrides the print-quality setting in the front panel.

 **NOTE:** You cannot change the print quality of pages that the printer is already receiving or has already received (even if they have not started to print yet).

## Select paper size

The paper size can be specified in the following ways.

 **NOTE:** The paper size specified here should be the paper size in which the document was created. It is possible to rescale the document to a different size for printing. See [Rescale a print on page 68](#).

- **In the Windows driver dialog:** Select the **Paper/Quality** or **Paper** tab (depending on the driver version), then select your paper size from the **Document Size** list.

 **NOTE:** If you are printing with the V4 driver and from Adobe Acrobat, the page size and orientation are determined by the application.

 **NOTE:** If your application offers no **Page Setup** dialog, use the **Print** dialog.

- **Using the front panel:** tap , then **Default printing configuration > Paper options > Paper size**.

 **NOTE:** If the paper size is set from your computer, it overrides the paper size setting in the front panel.

## Custom paper sizes

If you want to choose a paper size that is not included in the list of standard paper sizes, there are various different ways to specify it.

### Use the Windows printer driver (version 3)

1. Click the **Paper/Quality** tab.
2. Click **Custom**.
3. Enter the name and dimensions of your new paper size.
4. Click **OK**. The new paper size is automatically selected.

### Use the Windows printer driver (version 4)

1. Click the **Paper** tab.
2. Click **Document size**.
3. Enter the dimensions of your new paper size into the two fields in the custom area.
4. Click the arrow button.

A custom paper size created with the printer driver has the following characteristics:

- The paper size is permanent. It will not disappear if the driver is closed or the computer is turned off.
- The paper size is local to the printer queue. It will not be seen from other printer queues in the same computer.
- In Domain server networks, the paper size is local to the computer. It will not be seen from other computers sharing the printer queue.
- In Workgroup networks, the paper size will be shared among all the computers sharing the printer queue.
- If the printer queue is deleted, the paper size is deleted with it.

### Use Windows forms

1. From the Start menu, or from the Control Panel, select **Printers and Faxes**.
2. From the **File** menu, select **Server Properties**.
3. In the **Forms** tab, check the **Create a new form** box.
4. Enter the name and dimensions of your new paper size. Leave the margins as 0.00.
5. Click the **Save Form** button.
6. Go to the printer driver, and select the **Paper/Quality** or **Paper** tab (depending on the driver version).
7. Select **More...** from the drop-down list of paper sizes.
8. Select your new paper size from the group of Custom sizes.

A custom paper size created with Windows forms has the following characteristics:

- The paper size is permanent. It will not disappear if the driver is closed or the computer is turned off.
- Restricted users cannot create paper forms. The “manage documents” role in the Windows Active Directory is the minimum required.
- The paper size is local to the computer. It will be seen in all the printer queues that have been created on the computer and that support paper of that size.
- If a printer queue is shared, this paper size will appear in all the client computers.
- If a printer queue is shared from another computer, this paper size will **not** appear on the driver’s document size list. A Windows form in a shared queue needs to be created in the server.
- If the printer queue is deleted, the paper size is not deleted.

## Select margin options

By default, the printer leaves a 5 mm margin between the edges of your image and the edges of the paper (increased to 22 mm at the foot of cut-sheet paper). However, you can change this behavior in several ways.

### Choose between 3 and 5 mm margins

- **In the Windows V3 driver dialog:** Select the **Advanced** tab, then click **Advanced features > Document options > Printer features > Margin**, and select the margin size.
- **In the Windows V4 driver dialog:** Select the **Layout** tab and select your margins from the **With Margins** list.
- **Using the front panel:** Tap , then **Printing preferences > Margins**.

### Choose margin layout options

- **In the Windows V3 driver dialog:** Select the **Paper/Quality** tab, and click the **Margins/Cutter Settings** button. The **Layout and Margins** window is displayed.
- **In the Windows V4 driver dialog:** Select the **Layout** tab and go to the **Layout Mode** area.
- **Using the front panel:** Tap , then **Default printing configuration > Margins layout**.

You will then see at least some of the following options.

- **Use application settings (drivers)/Use standard (front panel).** Your image will be printed on a page of the size you have selected, with a narrow margin between the edges of the image and the edges of the paper. The image should be small enough to fit between the margins.
- **Oversize.** Your image will be printed on a page slightly larger than the size you have selected. If you cut off the margins, you will be left with a page of the size you selected, with no margins remaining between your image and the edges of the paper.
- **Clip contents by margins.** Your image will be printed on a page of the size you have selected, with a narrow margin between the edges of the image and the edges of the paper. In this case, if the image is the same size as the page, the printer assumes that the extreme edges of the image are either white or unimportant, and do not need to be printed. This may be useful when your image already contains a border.

## Print on loaded paper

To print a job on whichever paper is loaded in the printer, choose the following Paper Type option in your printer driver:

- **In the Windows driver dialog:** Select the **Paper/Quality** or **Paper** tab (depending on the driver version), then select **Use Printer Settings** in the Paper Type drop-down list.

---

 **NOTE:** Use **Printer Settings** (Windows) or **Any** (Mac OS X) is the default Paper Type selection.

---

## Rescale a print

You can send an image to the printer at a certain size but tell the printer to rescale it to a different size (normally larger). This may be useful:

- If your software does not support large formats
- If your file is too large for the printer's memory—in this case, you can reduce the paper size in your software and then scale it up again using the front-panel option

You can rescale an image in the following ways:

- **In the Windows driver dialog:** Go to the **Layout Output** or **Layout** tab (depending on the driver version) and look at the Resizing Options section.
  - The **Actual size** option leaves the size of the image unchanged.
  - The **Fit to** option adjusts the image size to the paper size you have selected. For example, if you have selected ISO A2 as the paper size and you print an A3-sized image, it is enlarged to fit the A2 paper. If the ISO A4 paper size is selected, the printer reduces a larger image to fit the A4 size.
  - The **% of actual size** or **Scale %** option (depending on the driver version) enlarges the printable area of the original paper size (the page minus the margins) by the percentage indicated, then adds the margins to create the output paper size.
- **Using the front panel:** Tap , then **Default printing configuration > Paper options > Resize**.

If you are printing to a single sheet, you must ensure that the image can actually fit onto the sheet, otherwise the image will be clipped.

## Change the treatment of overlapping lines

---

 **NOTE:** This topic applies only when printing an HP-GL/2 job.

---

The merge option controls the overlapping lines in an image. There are two settings:

- **Off:** Where the lines cross, only the color of the top line is printed. This is the default setting.
- **On:** Where the lines cross, the colors of the two lines merge.

To turn merge on, go to the front panel and tap , then **Default printing configuration > HP-GL/2 options > Merge**. You can set the merge option from your software in some applications. Settings in your software override the front-panel settings.

## Preview a print

Previewing a print on the screen allows you to check the layout of the print before printing, which may help you to avoid wasting paper and ink on a bad print.

- To preview a print under Windows, you have the following options:

- Use the HP Print Preview application:

Check the **Show preview before printing** box, which you can find in the right bottom corner of the driver dialog. Click **Print**, then wait a few seconds for the HP Print Preview application to be launched.

Check that the preview of the job is what you wanted. If so, click **Print**, otherwise click **Cancel**; you can readjust the driver settings before trying again.

---

 **NOTE:** The **Show preview before printing** box appears in the driver dialog only if HP Print Preview is installed in your computer. See [HP Print Preview on page 12](#).

---

- Use your application's print preview option.
- To preview a print under Mac OS X, you have the following options:
  - Use your application's print preview option.
  - There is no **Preview** button at the bottom of the Print dialog box in the latest versions of Mac OS X. A print preview is always shown at the upper left of the Print dialog box for most applications.
  - Choose the **HP Print Preview** option from the **PDF** menu at the bottom of the Print dialog box. The print preview is displayed by a separate HP Print Preview application.

## Print a draft

You can specify fast draft-quality printing in the following ways:

- **In the Windows driver dialog:** Go to the **Paper/Quality** or **Paper** tab (depending on the driver version) and look at the Print Quality section. Move the print-quality slider to the extreme left ('Speed').
- **Using the front panel:** Tap , then **Default printing configuration > Print quality > Select quality level > Fast**.

You can specify even faster draft-quality printing by using Economode, as follows. This is intended mainly for documents containing only text and line drawings.

- **In the Windows driver dialog:** Go to the **Paper/Quality** or **Paper** tab (depending on the driver version) and look at the Print Quality section. Select **Custom Options** or **Advanced** (depending on the driver version), then set the quality level to **Fast** and check the **Economode** box.
- **Using the front panel:** Tap , then **Default printing configuration > Print quality > Enable economode**.

---

 **NOTE:** If the print quality is set from your computer, it overrides the print-quality setting in the front panel.

---

## High-quality printing

You can specify high-quality printing in the following ways:

- **In the Windows driver dialog:** Go to the **Paper/Quality** or **Paper** tab (depending on the driver version) and look at the Print Quality section. Move the print-quality slider to the extreme right ('Quality').
- **Using the front panel:** Tap , then **Default printing configuration > Quality level > Best**.

---

 **NOTE:** If the print quality is set from your computer, it overrides the print-quality setting in the front panel.

---

## If you have a high-resolution image

If your image has a resolution greater than the rendering resolution (which you can see in the Custom Print Quality Options box under Windows), print sharpness may be improved by selecting the **Maximum detail** option. This option is available only if you are printing on glossy paper and you have selected **Best** print quality.

- **Using the front panel:** Tap , then **Default printing configuration > Print quality > Enable maximum detail**.

---

 **NOTE:** The **Maximum detail** option results in slower printing with photo papers, but it does not increase the amount of ink used.

---

## Print in gray shades

You can convert all colors in your image to shades of gray: see [Printing in grayscale on page 91](#).

## Print with crop lines

Crop lines indicate where the paper should be cut to reduce it to your selected page size. You can print crop lines with individual jobs in the following ways:

- **In the Windows V3 driver dialog:** Select the **Paper/Quality** tab, then click the Margins/Cutter **Settings** button. Check the **Draw cutting lines** box in the **Layout and Margins** window.
- **In the Windows V4 driver dialog:** Select the **Output** tab and check the **Crop lines** box.

Alternatively, you can choose to print crop lines with all jobs by default:

- **Using the front panel:** Tap , then **Default printing configuration > Paper options > Enable crop lines > On**.

To print crop lines with nested jobs (see [Nest jobs to save roll paper on page 71](#)), you must select a different option:

- **Using the front panel:** Tap , then **Job management > Nest options > Enable crop lines > On**.

## Use paper economically

Here are some recommendations for making economical use of paper:

- If you are printing relatively small images or document pages, you can use nesting to print them side by side instead of one after another. See [Nest jobs to save roll paper on page 71](#).
- You may be able to save some roll paper by using the following options:
  - **In the Windows driver dialog:**

- With a version 3 driver: Click the **Paper/Quality** tab, then the Margins/Cutter **Settings** button, then check the box **Remove blank areas**.
- With a version 4 driver: Click the **Output** tab, then **Roll options**, then check the box **Remove blank areas**.

You can also select the **Layout/Output** or **Layout** tab (depending on the driver version) and then select one of the **Rotation** options.

- If you check the print preview on your computer before printing, you can sometimes avoid wasting paper on prints containing obvious mistakes. See [Preview a print on page 69](#).

## Nest jobs to save roll paper

Nesting means automatically printing images or document pages side by side on the paper, rather than one after the other. This is done to avoid wasting paper.

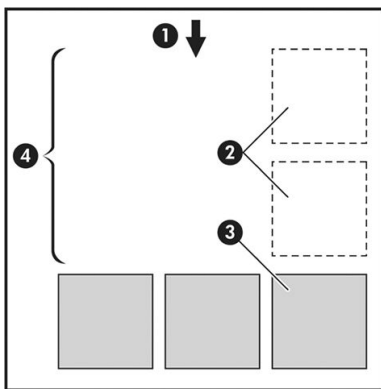

1. Direction of paper flow
2. Nesting off
3. Nesting on
4. Paper saved by nesting

## When does the printer try to nest pages?

When both of the following are true:

- The printer is loaded with roll paper, not sheet paper.
- The printer's **Nest** option is turned on. See [How to turn nesting on and off on page 72](#).

## What pages can be nested?

All pages can be nested, unless they are so large that two of them cannot fit side by side on the roll, or unless there are too many of them to fit into the remaining length of the roll. A single group of nested pages cannot be split between two rolls.

## Which pages qualify for nesting?

In order to be in the same nest, the individual pages must be compatible in all of the following ways:

- All pages must have the same print quality setting (**Economode**, **Fast**, **Normal** or **Best**).
- The **Maximum Detail** setting must be the same on all pages.
- The **Layout/Margins** setting must be the same for all pages.
- The **Mirror Image** setting must be the same for all pages.
- The **Rendering Intent** must be the same for all pages.
- The **Cutter** setting must be the same for all pages.
- Pages must be all color, or all grayscale: not some in color and some in grayscale.
- All pages must be in one or other of the following two groups (the two groups cannot be mixed in the same nest):
  - PCL3, RTL, TIFF, JPEG
  - PostScript, PDF
- JPEG and TIFF pages with resolutions greater than 300 dpi may not nest with other pages in some cases.

## How to turn nesting on and off

To turn nesting on or off, you must first make sure that the start of printing is set to **After Processing** (see [Select when to print a job on page 81](#)).

Then go to the front panel and tap , then **Job management** > **Nest options** > **Nesting**.

You will see the following options:

- **In order:** Pages are nested in the order in which they are sent to the printer (this is the default option). The nested pages are printed as soon as one of three conditions is met:
  - The next page will not fit on the same row as the other pages already nested.
  - No page has been sent to the printer during the specified wait time.
  - The next page is incompatible with the pages already nested (see [Nest jobs to save roll paper on page 71](#)).
- **Optimized order:** Pages are not necessarily nested in the order in which they are sent to the printer. When it receives an incompatible page, the printer holds it and waits for compatible pages to complete the nest. The nested pages are printed as soon as one of three conditions is met:
  - The next page will not fit on the same row as the other pages already nested.
  - No page has been sent to the printer during the specified wait time.
  - The incompatible-page queue is full. The printer can queue up to six incompatible pages while nesting compatible pages. If it receives a seventh incompatible page, the nest is printed as it is.
- **Off:** nesting is disabled.



---

 **TIP:** **Optimized order** uses the minimum amount of paper; however, it may take longer to print because the printer waits for compatible pages to arrive.

---

## How long does the printer wait for another file?

So that the printer can make the best nest possible, it waits after a file has been received to check whether a subsequent page will nest with it or with pages already in the queue. This waiting period is the nest wait time; the factory default nest wait time is 2 minutes. This means that the printer waits for up to 2 minutes after the last file is received before printing the final nest. You can change this waiting time from the printer's front panel: tap , then **Job management** > **Nest options**, and select the wait time. The available range is 1 to 99 minutes.

While the printer is waiting for nesting to time out, it displays the remaining time on the front panel and in the Embedded Web Server.

## Use ink economically

Here are some recommendations for making economical use of ink:

- For draft prints, use plain paper and move the print-quality slider to the left end of the scale ('Speed'). For further economy, select custom print quality options, then select **Fast** and **Economode**.
- Clean the printheads only when needed, and clean only those printheads that need cleaning. Cleaning the printheads can be useful, but it uses a small amount of ink.
- Leave the printer permanently turned on so that it can maintain the printheads in good condition automatically. This regular printhead maintenance uses a small amount of ink. However, if it is not done, the printer may need to use much more ink later to restore the health of the printheads.
- Wide prints make more efficient use of ink than narrow prints, because printhead maintenance uses some ink, and its frequency is related to the number of passes made by the printheads. Therefore, nesting jobs can save ink as well as saving paper (see [Nest jobs to save roll paper on page 71](#)).

## Protect a paper type (T1600dr only)

You can protect selected paper types to avoid printing on them unintentionally. A protected paper type will be printed on only when the paper type is explicitly specified in the job.

To protect a paper type, tap , then **Job management** > **Roll policies** > **Protected paper types**, then select the category of paper you want to protect.

When a paper type is protected, the  icon appears before the paper name.

To print on a protected paper category, just select the paper type explicitly when submitting the job from a printer driver or other job submission software.

---

 **NOTE:** If a protected paper type is not explicitly selected, and no other paper types are available, an out-of-paper message will appear.

---

## Unattended printing/overnight printing

The printer is well suited to long, unattended print jobs, having multiple rolls plus robust and consistent image quality.

Here are some recommendations to help you deal with a long queue of printing jobs.

- If feasible, use brand-new long rolls of paper.
- If you want to print on partly-used rolls, you can check the paper type and the remaining length in the Embedded Web Server or in the front panel, to confirm that you have enough paper to print all your jobs.



**NOTE:** Information on the remaining length is available only if you told the printer the length of the roll when you loaded it, or if the printer read the length of the roll from the barcode printed on it.

- If you have a T1600dr printer, load two rolls of paper suitable for your jobs. If the printer finishes one roll, it will automatically switch to the other.
- HP recommends the use of papers approved for your printer. See [Supplies and accessories on page 137](#).
- Check that you have paper wide enough to print all of your jobs. Any jobs that are too wide may be put on hold for paper if the paper mismatch action is set to **Put job on hold** (see [Solve paper mismatch on page 82](#)).
- Check the ink levels remaining in your ink cartridges.
- When you have submitted your print jobs, you can use the Embedded Web Server from a remote location to monitor their status.
- Drying time should be set to **Optimal**.
- Tap , then **Job management > Roll policies > Use most depleted roll > On**.

We recommend the following settings, depending on the paper type and what kind of prints you are making.

#### Recommended settings for unattended printing

Print type	Print mode	Maximum detail	Drying time	Paper types
Lines	Normal	Off	Optimal	Coated, Bond, Heavyweight Coated, Glossy
Lines and fills	Normal	Off	Optimal	Coated, Bond, Heavyweight Coated, Glossy
Maps	Best	Off	Optimal	Coated, Heavyweight Coated, Glossy
Renderings, photographs	Best	Off	Optimal	Coated, Heavyweight Coated, Glossy

---

# 6 Mobile printing

- [Introduction](#)
- [Print from Android](#)
- [Print from Chrome OS](#)
- [Print and share from the HP Smart App](#)
- [Print by email \(HP ePrint\)](#)
- [Mobile specifications](#)

## Introduction

You can print to your printer from many mobile devices and from almost any location. There are two main methods of Mobile Printing:

- Direct printing by connection to the same network
- Printing by e-mail

Your printer can be connected to the Web, providing various benefits:

- Automatic firmware updates (see [Update the firmware on page 134](#))
- Print on HP printers from almost anywhere
- Print on HP printers from almost any device, including smartphones, tablets, and laptops

See <http://www.hp.com/go/designjetmobility> for more detailed information.

You can enable Web Services when setting up the printer: see [Set up printer services on page 15](#) or the Assembly Instructions for more information.

---

 **IMPORTANT:** The printer must be connected to a network with Internet access: connect an Ethernet cable. See [Connect the printer to your network on page 14](#).

---

## Print from Android

---

 **NOTE:** Printing is only available from applications that offer printing or sharing.

---

For Android printing, install and enable the HP Print Service App from Google Play (<https://play.google.com/store/apps/details?id=com.hp.android.printservice&hl=en>), if it is not already installed in your device. You must have Android KitKat 4.4 or later.

1. Open the document or photo you want to print, and press the menu icon, and select **Print**.
2. Choose your printer from the list.
3. Check the print settings, then press **Print**.

## Print from Chrome OS

Printing from Chromebook devices is as easy as installing the HP Print for Chrome extension from the Chrome Web Store (<https://chrome.google.com/webstore/detail/hp-print-for-chrome/cjanmonomjogheabiocdamfpknlpdehm>).

1. Choose your content. Open the document or photo you want to print, tap the **menu icon** and select **Print**.
2. Choose your printer. Select from the list of printers that appears.
3. Confirm that the correct printer and print setting are selected. Tap **Print** and collect your printed documents.

---

 **NOTE:** Printing is only available from applications that offer printing or sharing.

---

# Print and share from the HP Smart App

Use the screen on your mobile device to control print functions. Print PDF, photos, email attachments, and more from virtually anywhere.

You can download the HP Smart App from the following locations:

- Android: <https://play.google.com/store/apps/details?id=com.hp.printercontrol>
- iOS: <https://itunes.apple.com/app/id469284907>

Make sure your device and printer are operating on the same network, and follow the steps below:

## iOS and Android printing with the HP Smart App

1. Open the HP Smart App and select your printer.
2. Select whether you want to print documents or photos from your local device, or link your Google Drive, Dropbox, or other accounts to access your content.
3. Use the edit options to adjust quality, color, and other settings if you wish to make such adjustments.
4. Tap **Print** and collect your printed documents.

## Print by email (HP ePrint)



**IMPORTANT:** To enable email printing, see [Enable email printing with HP ePrint on page 16](#).

If you can email it, you can print it. Simply attach a PDF or other print-ready file to an email message, and send it to your printer's dedicated address.

You can print from anywhere with an Internet connection, with no need for a printer driver, but there are a few limitations to bear in mind:

- The attached files to be printed must be in PDF format.
- The maximum file size is 10 MB, but your email server may have a lower limit.
- Files are printed in the original document size (at 100% scale), in normal quality, in color, and normally in portrait orientation (some printers may offer autorotation).

For more information, see <https://www.hpconnected.com>.

## Mobile specifications

- Mobile devices must have an Internet connection and email capability.
- Print requires the mobile device and printer to be on the same network.
- Printing by email also requires the printer to be connected to the Internet.
- iOS 7.0 and above, or Android KitKat4.4 and above, is required.

---

# 7 Job queue management

- [Job queue in the front panel](#)
- [Job queue in the Embedded Web Server or HP DesignJet Utility](#)

# Job queue in the front panel

Tap  on the home screen to view the job queue on the front panel.

The print queue includes jobs that are being received, parsed, rendered, printed, already printed, and so on.

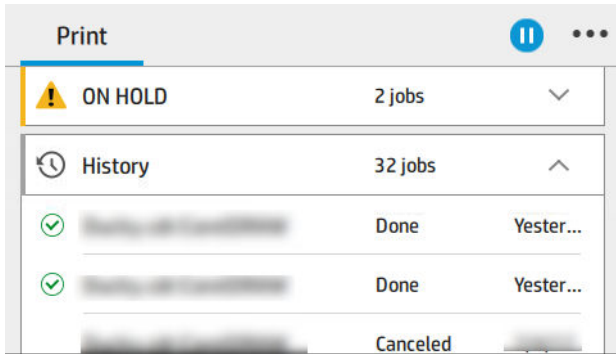

Tap the name of the job to see all the job details, including information about status, pages, copies, total, and preview.

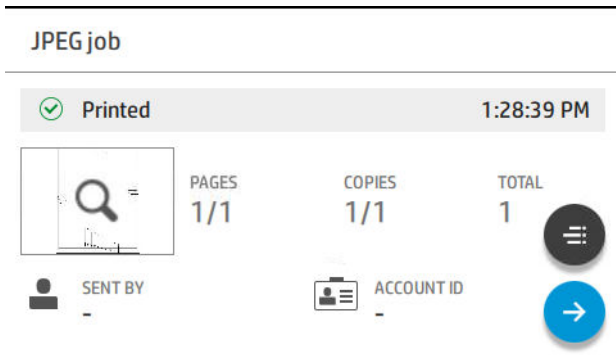

In an active queue, the job you are printing appears in the middle of the queue, with printed jobs below and jobs to be printed above. You can scroll up and down. Once scrolled, the queue remains static and does not move automatically.

Jobs in the left pane are divided into four categories (Up next, Now printing, On hold, and History) in chronological order starting from the top. On hold is shown only when there are one or more jobs on hold. Below the job name, you can see its status:

## Up next

- **Waiting to process:** The job has been received by the printer and is waiting to be rendered.
- **Processing:** The printer is parsing and rendering the job.
- **Waiting to print or Paused:** The job is processed and waiting for the print engine to be ready to proceed with printing.

## Now printing

The job is being printed.

- **Paused:** The job is paused.



**NOTE:** Sometimes, while printing, you may see a **Self-servicing** status, which means that the printer is performing some task such as paper type change or print mode change between pages of the same job.

## On hold



The job will not be printed until you take some action. You should respond in one of the following ways:

- **On hold: Private job:** Enter the PIN required to print the job. The job will be deleted from the queue after printing.
- **Oh hold: Personal job:** The job is not automatically printed: you must select it from the queue. No details can be seen.
- **On hold to preview:** The job is not automatically printed: you must select it from the queue.
- **On hold for paper mismatch:** Load the paper required by the job.
- **On hold for accounting:** Enter an account ID to be used for the job.
- **On hold: Recovered job:** After a printer recovery, some jobs that were not printed are kept on hold.

## History



- **Printed:** In chronological order, divided into today, yesterday, last week, and so on.
- **Canceled:** Canceled by the user.
- **Failed:** The job has failed for one or more reasons.

## Job queue actions

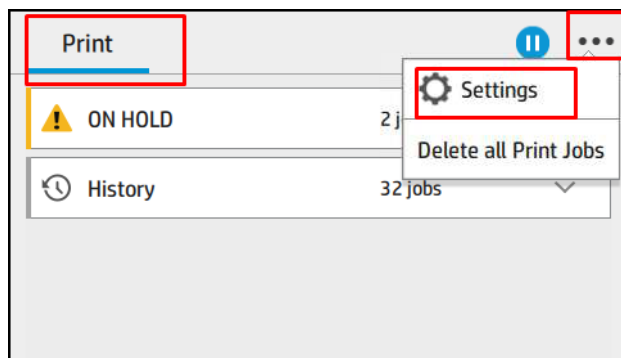
Some of the actions in the job queue are determined by the settings selected. Some default settings may be worth changing, depending on your environment. To do so, tap  in the home screen, then **Job management**. Alternatively, in the job queue app, tap  at the top right, then **Settings**.



## Pause the job queue

You can pause the job queue by tapping  and resume by tapping . The pause takes effect at the end of the page that is currently printing.



## Reprint

In the History section, tap the job you want to reprint. On the details screen, tap the **Printer** button, then , then **Reprint**. On the next screen, you can select the number of copies, the source, and the destination.

## Print next

If you want to change the position of a job in the queue to be printed immediately after the currently printing job, select the desired job and tap the **Print next** button.

## Select when to print a job

 **NOTE:** The When To Start Printing options cannot be used with PostScript jobs.

You can select at what point you want to print a job in the queue. Tap , then **Job management > When to start printing**.

There are three options you can select:

- When **After Processing** is selected, the printer waits until the whole page has been processed and then it starts to print. This is the slowest setting but ensures the best print quality in large or complex prints.
- When **Immediately** is selected, the printer prints the page as it is processed. This is the quickest setting, but the printer may stop halfway through a print to process data. This setting is not recommended for complex images with dense color.
- When **Optimized** is selected (this is the default setting), the printer calculates the best time to begin printing the page. It is usually the best compromise between the **After Processing** and **Immediately** settings.

## See job details

Tap the name of the job to show its details, including information about status, pages, copies, total, and preview. Scroll down as necessary to see all of the information.

By tapping the thumbnail, you can navigate over all pages of the job. From there you can zoom in and out (pinch and zoom) and see more information about each page: tap the  icon at the bottom of the page.

In an active queue, the job you are printing appears in the middle of the queue, with printed jobs below and jobs to be printed above.

## Roll policies

At the front panel, tap , then , then , then **Roll policies**.

Alternatively, tap , then **Job management > Roll policies**.



The following options are available:

- **Increase productivity:** To increase the productivity of the printer.
  - **Job autorotation:** The printer can rotate a job automatically in order to save paper.
- **Automatic roll selection:**

- **Roll width selection:** The printer can be more or less restrictive when selecting the roll width on which to print. You can select:
  - **Print on the same width only:** Each page prints on a roll with the same page width.
  - **Print on the same width or wider:** Each page prints on a roll with the same width or wider.
- **Use most depleted roll** (T1600dr only): When there are two or more rolls with the same paper type and width, the roll selected is the roll with less paper.
- **Paper type protection** (T1600dr only): You can avoid printing accidentally on special paper types by protecting them. Protected types are eligible for printing only when paper type or roll are specified in the job.

See also [Protect a paper type \(T1600dr only\) on page 73](#).

## Solve paper mismatch

If the paper currently loaded in the printer is not suitable for a particular job or page, the printer can automatically solve the conflict or give a number of choices depending on the printer policies. Such a conflict may be caused by a job sent to the printer with no specific roll or paper type assigned to it, or by a roll coming to its end during printing. The following options are available in the paper mismatch settings menu; you can reach this menu from the job queue by tapping **⋮**, then , then **Mismatch actions > Paper mismatch**; or by tapping , then **Job management > Mismatch actions > Paper mismatch**.

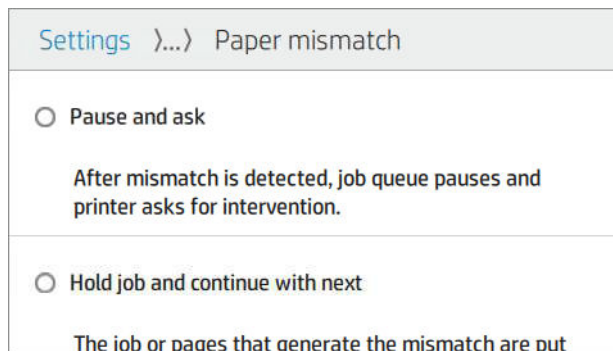

- **Pause and ask** (the most restrictive option): Printing stops until the correct paper is loaded. This option is recommended when the printer is attended. A message appears, asking what you want to do: cancel the job, print anyway, put on hold, or load paper. These options are also available in the job queue.
- **Hold job and continue with next:** Put mismatched jobs on hold until the correct paper is loaded, and continue printing the rest of the job queue. The printer sends an alert whenever a job is put on hold. This option is recommended when the printer is unattended, even though the integrity of a job may be disrupted, to avoid stopping the queue. Once the paper required for the job is loaded, the job or pages are automatically resumed.
- **Print anyway** (the least restrictive option): Print on whatever paper is loaded. The printer will choose the roll to print according to the following criteria: first where the page fits and then the same paper type. This option will never select a paper type that has been protected.

## Job queue options

To change the job queue options, tap , then **Job management > Job queue**.

You can select the maximum number of printed jobs to have in the queue, when to delete printed jobs, and whether to delete jobs on hold after a specified time.

## Default printing preferences

At the front panel, tap , then **Default Printing configuration** to define the default properties of jobs sent to your printer from remote locations.

You can define settings in the following areas: Print quality, Color, Paper, Margins, HP-GL/2, PostScript, Print retrieval.

## Job deletion

If the printer runs out of storage space for new jobs, the oldest printed jobs are automatically deleted from the queue.

You can request that printed jobs should be automatically deleted from the queue when the total number of printed jobs exceeds a specified limit (the maximum number in the history setting), or when the jobs were printed more than a specified time ago (clear history settings).

To delete jobs on hold, the setting **Delete jobs on hold** allows you to define the time after which these jobs will be removed (2–48 h).

To delete a job manually, select the job and tap **Delete** in the  menu. To delete all jobs, tap **Delete all jobs** in the  menu; the whole job queue will be deleted.

The **Delete** option deletes the job from the queue, while the **Cancel** option cancels the job but leaves it in the queue, marked as **Canceled by the user** in the history category.

To cancel a job while printing, tap **X**. To cancel a job from the Up Next category, tap the job name on the list and then tap **Cancel job** on the bottom right.

---

 **NOTE:** If you tap **X**, you cancel the currently printing job only.

---

## Job queue in the Embedded Web Server or HP DesignJet Utility

The HP DesignJet Utility provides a different way of accessing the Embedded Web Server's job management facilities, but the facilities are exactly the same whether you use the Embedded Web Server or the HP DesignJet Utility.

To see the queue in the Embedded Web Server, select **Job queue** in the **Main** menu.

## Job queue page

By default, access to the job queue is open to all users. An administrator can set a password so that users are required to enter a password to access the page.

The job queue page shows all jobs that are available in the print queue. The print queue includes jobs that are being received, parsed, rendered, printed and already printed.

The Embedded Web Server displays the following information for each print job:

- **File name:** The name of the job.
- **Status:** The current status of the job.

- **Pages:** The number of pages in the job.
- **Copies:** The number of copies printed.
- **Total:** The total number of pages (including copies).
- **Sent by:** The username.
- **Account ID:** The account ID for the job.
- **Date:** The date and time attached to the job that was received by the printer, shown in the locale of the Embedded Web Server.
- **File source:** The application from which the job was sent to print.
- **Paper destination:** The output option selected for the printed job.

Jobs in the queue can be sorted by any of the information items (except Preview) by clicking on the title of the corresponding column. You can perform the following operations on one or all jobs in the queue:

- **Cancel:** Cancels the selected jobs. You are asked to confirm before the job is canceled. The job remains stored in the printer, but will not be printed unless you click **Reprint**.
- **Hold:** Holds the select jobs until you click **Continue** to print.
- **Resume:** All selected jobs, which are on hold, continue printing.
- **Reprint:** Prints more copies of a job.
- **Next print:** Sends all selected jobs to the top of the job queue.
- **Print anyway:** The printer will try to print the job even if there is some problem with it.
- **Delete:** Deletes selected jobs from the job queue. You are asked to confirm before the job is deleted.

## Prioritize a job in the queue

You can select any job in the queue and make it the next one to be printed. After selecting the job, click **Move to front**.

If nesting is turned on, the prioritized job may still be nested with others. If you really want this job to be printed next, and not nested with others, first turn nesting off in the front panel and then move it to the front of the queue.

In the following cases, the **Next print** button is not displayed:

- The job is already at the front of the queue.
- The job is on hold—in this case the **Resume printing** button is displayed instead.
- The job has finished—in this case the **Reprint** button is displayed instead.
- The job has some error condition.

## Delete a job from the queue

Under normal circumstances, there is no need to delete a job from the queue after printing it, as it will just fall off the end of the queue as more files are sent. However, if you have sent a file in error, and want to avoid printing it, you can simply select the job and then click **Delete**.

In the same way, you can delete a job that has not been printed yet.

If the job is currently being printed (its status is **printing**), you can click **Cancel** and then **Delete**.

## Reprint a job in the queue

To reprint an already-printed job, select the job from the queue, then click **Reprint**. When reprinting a print job, you cannot change the print settings, because the job has already been rasterized.

## Job status messages

These are the possible job status messages, approximately in the order in which they may be seen:

- **Downloading:** The printer is receiving the job from the computer.
- **Processing:** The printer is parsing and rendering the job.
- **Waiting to print:** The job is waiting for the print engine to become free to proceed with printing.
- **Nested:** The printer is set up with Nesting=On and is waiting for other jobs in order to complete the nest and proceed with printing.
- **Preparing to print:** The printer is performing writing system checks before printing the job.
- **On hold for preview:** The job was sent with the **on hold for preview** option.



---

**NOTE:** If the printer hangs up while printing a job, and the queue facility is turned on, the partially printed job will appear in the queue as **on hold** when the printer is next turned on. When you resume the job, it will start printing at the page at which it was interrupted.

---

- **On hold for paper:** The job cannot be printed because the right paper is not loaded in the printer. Load the required paper, see [Paper handling on page 31](#), and click **Continue** to resume the job.
- **On hold for accounting:** The job cannot be printed because the printer requires all jobs to have an account ID: enter the account ID and then click **Continue** to resume the job.



---

**TIP:** To set an account ID, see [Require account ID on page 27](#).

---

- **Printing**
- **Drying**
- **Cutting paper**
- **Ejecting page**
- **Canceling:** The job is being canceled, but will remain in the printer job queue.
- **Deleting:** The job is being deleted from the printer.
- **Printed**
- **Canceled:** The job has been canceled by the printer.
- **Canceled by user**
- **Empty job:** The job does not contain anything to print.

## Reactivate a job on hold

When the printer puts a job on hold you receive an alert, see [Alerts on page 181](#), which explains why the job is on hold. Follow the instructions on the screen to remove the hold and continue printing.

---

# 8 Color management

- [Introduction](#)
- [How colors are represented](#)
- [A summary of the color management process](#)
- [Color calibration](#)
- [Color management from printer drivers](#)
- [Color management from the front panel](#)

## Introduction

Color management is performed using a set of software tools that allow you to reproduce a color as accurately as possible on any display or printing device.

In addition, your printer has been engineered with advanced hardware and software features to ensure predictable and dependable results.

- Color calibration for consistent colors
- The Photo Black ink provides pure blacks when printing on photo papers

## How colors are represented

Color is usually represented as an array of numbers: three numbers in the RGB color model or four in the CMYK color model. These numbers are a measure of the base colors used in a mixture to create a given color. RGB means that we are using a mixture of Red, Green, and Blue to create any specific color. In the case of CMYK, the mixture is of Cyan, Magenta, Yellow, and Key (where Key means black, for historical reasons).

Most monitors use the RGB color model, while most printers use the CMYK color model.

An image can be converted from one color model to another, but in general the conversion is not perfect. Your printer uses the RGB color model: the same color model that is used by your monitor.

This simplifies but does not completely solve the problem of matching colors. Each device represents colors a little differently from another device, even if they use the same color model. However, color management software can adjust the colors in an image according to the characteristics of the particular device, using a color profile of the device, in order to achieve correct colors.

## A summary of the color management process

To get the accurate and consistent colors that you want, you should follow these steps for each paper type that you use.

1. Color-calibrate the paper type, for consistent colors. Calibration should be repeated every now and then (see [Color calibration on page 88](#)). In addition, you may wish to calibrate immediately before a particularly important print job for which color consistency is vital.
2. When printing, select the correct paper preset for the paper type you are using. The paper preset contains the color profile\* as well as various other characteristics of the paper. See [Paper presets on page 44](#).

\*A color profile is a description of a printer, ink, and paper combination, that contains all the information required for these color conversions.



## Color calibration

Color calibration enables your printer to produce consistent colors with the particular printheads, inks and paper type that you are using, and under your particular environmental conditions. After color calibration, you can expect to get similar prints from any two different printers situated in different geographical locations.

Some paper types cannot be calibrated. For all other paper types, calibration should be done in any of the following circumstances:



- Whenever a printhead is replaced
- Whenever a new paper type is introduced that has not yet been calibrated with the current set of printheads
- Whenever the environmental conditions (temperature and humidity) change significantly

You can check the color calibration status of the currently loaded paper at any time by going to the front panel and tapping , then , then , then **Color calibration status**. The status may be one of the following:

- **Recommended:** The paper has not been calibrated.

---

 **NOTE:** Whenever you update the printer's firmware, the color calibration status of all papers is reset to **Recommended**.

---

- **Obsolete:** The paper has been calibrated, but the calibration is now out of date because a printhead has been replaced, and should be repeated.
- **Done:** The paper has been calibrated, and the calibration is up to date.
- **Disabled:** This paper cannot be calibrated.

---

 **NOTE:** Color calibration cannot be performed on plain paper, nor on any kind of transparent material.

---

You can start color calibration from the front panel: tap , then **Color calibration.**, and press **Continue**. Choose the paper and press **OK**.

The calibration process is fully automatic and can be performed unattended after you have loaded paper of the type you wish to calibrate—which should be wider than 355 mm (14 in). If you have more than one roll loaded, the printer will ask which roll you want to use for the calibration.

The process takes about 3–5 minutes and consists of the following steps:

1. A calibration chart is printed, which contains patches of each ink used in your printer.



2. The chart is allowed to dry for a period of time that depends on the paper type, so that the colors have time to stabilize.
3. The chart is scanned and measured.
4. From the measurements, the printer calculates the necessary correction factors to apply for consistent color printing on that paper type. It also calculates the maximum amount of each ink that can be applied to the paper.

# Color management from printer drivers

## Color management options

The aim of color management is to reproduce colors as accurately as possible on all devices: so that, when you print an image, you see very similar colors as when you view the same image on your monitor.

There are two basic approaches to color management for your printer:

- **Printer-Managed Colors:** In this case your application program sends your image to the printer without any color conversion, and the printer converts the colors to its own color space. The details of this process depend on the graphics language that you are using. HP recommends this setting for the best experience and results.
  - **PostScript:** The PostScript and PDF interpreter modules perform the color conversion using the profiles stored in the printer and any additional ICC color profiles sent with the PostScript job. This kind of color management is done when you are using the PostScript or PDF driver.
  - **Non-PostScript (PCL3, CALS/G4):** The color management is done using a set of stored color tables. ICC profiles are not used. This method is somewhat less versatile than the alternatives, but is a little simpler and faster, and can produce good results with standard HP paper types.



---

**NOTE:** In non-PostScript printing, the printer can convert to sRGB if you are using Windows, or to Adobe RGB if you are using Mac OS X.

---

- **Application-Managed Colors:** In this case your application program must convert the colors of your image to the color space of your printer and paper type, using the ICC profile embedded in the image and the ICC profile of your printer and paper type.



---

**IMPORTANT:** Make sure to select matching settings in the driver and in the application.

---

You are recommended to consult the HP Support Center (see [HP Support Center on page 184](#)) to see how to use the color management options of your particular application. See also [Print a document with the correct colors on page 97](#).

To choose between **Application-Managed Colors** and **Printer-Managed Colors**:

- **In the Windows driver dialog:** Select the **Color** tab.
- **In some applications:** You can make this choice in the application.

## Color options

### Printing in color

The printer prints in color by default.

You can select color printing explicitly in the following ways:

- **In your application program:** Many programs provide this option.
- **In the Windows driver dialog:** Go to the **Color** tab and look at the Output Color or Color Options section (whichever is available in your driver). Select **Print in color**.

## Printing in grayscale

You can convert all colors in your image to shades of gray in the following ways:

- **In your application program:** Many programs provide this option.
- **In the Windows driver dialog:** Go to the **Color** tab and look at the Output Color or Color Options section (whichever is available in your driver). Select **Print in grayscale**.

## Printing in pure black and white

You can convert all colors in your image to pure black and pure white in the following way:

- **In the Windows driver dialog:** Go to the **Color** tab and look at the Output Color or Color Options section (whichever is available in your driver). Select **Print in pure black and white**.

## HP Professional PANTONE Emulation

When you use a named PANTONE color in an image, your application will normally send to the printer a CMYK or RGB approximation to that color. But the application does not take the printer or the paper type into account, it merely produces a generic approximation of the PANTONE color, which will look different on different printers and on different papers.

HP Professional PANTONE Emulation can do a much better job by taking into account the characteristics of the printer and the paper type. The results look as similar to the original PANTONE colors as is possible on a given printer using a given paper type. This technology is designed to produce emulations similar to those set up manually by prepress professionals.

To use HP Professional PANTONE Emulation, all you have to do is to turn it on. In fact, it is normally on by default.

- **In the Windows PostScript/PDF driver dialog:** Go to the **Color** tab and select **HP Professional PANTONE Emulation**.
- **From the front panel:** Tap , then **Default printing configuration > Color options > HP Pantone Emulation**.
- **In the Embedded Web Server:** From the main menu, select the **Color** tab.

HP Professional PANTONE Emulation not only provides the closest match that can be achieved on your printer; it also gives clear information on how close the emulation is to the original spot color.

## Default color spaces

When a document or image does not specify the working color space in which the content is originally described, the user can choose among different standards. That is, the user can determine how data should be interpreted by the color management system during the rendering process.

You can set source profiles in the following ways:

- **In the Windows PostScript/PDF driver dialog:** Select the **Color** tab, and **Printer Managed Colors**.

The standard way of encapsulating such information is in ICC profiles. As part of the solution, we provide the most common standards for the different devices.

The options are as follows.

## Default RGB source profiles

Your printer is provided with the following color profiles:

- **None (Native):** No imitation, for use when the color conversion is done by the application or operating system, and therefore the data arrive at the printer already color-managed. Available for PostScript and PDF drivers only.
- **sRGB IEC61966-2.1** imitates the characteristics of the average PC monitor. This standard space is endorsed by many hardware and software manufacturers, and is becoming the default color space for many scanners, printers and software applications.
- **Adobe RGB (1998)** provides a fairly large gamut of RGB colors. Use this space if you need to do print production work with a broad range of colors.
- **ColorMatch RGB** imitates the native color space of Radius Pressview monitors. This space provides a smaller gamut alternative to Adobe RGB (1998) for print production work. Available for PostScript and PDF drivers only.
- **Apple RGB** imitates the characteristics of the average Apple monitor, and is used by a variety of desktop publishing applications. Use this space for files that you plan to display on Apple monitors, or for working with old desktop publishing files. Available for PostScript and PDF drivers only.

## Default CMYK source profiles

You can choose from a selection of CMYK source profiles recognized by the printer. The default CMYK profile is Coated FOGRA39 (ISO 12647 - 2:2004), available for PostScript drivers only.

## Color management from the front panel

You can color-calibrate the loaded paper type from the front panel by tapping , then **Color calibration**, then **Continue** and choose paper. See [Color calibration on page 88](#).

The other color options in the front panel can all be found by tapping , then **Default printing configuration** > **Color options** (they can also be found under **Advanced printing preferences**).

### Color/Grayscale

- **Print in color**
- **Print in grayscale**
- **Print in pure black and white**

### RGB source profile

You can choose from a selection of RGB source profiles recognized by the printer. Default: **sRGB IEC 1966-2.1**.

- **Select CMYK source profile:** You can choose from a selection of CMYK source profiles recognized by the printer. Default: **Coated FOFRA39 (ISO12647-2:2004)**.
- **Select rendering intent:** You can select the rendering intent. Default: **Perceptual**.
- **Black point compensation:** You can turn black point compensation on or off. Default: **On**.
- **HP Professional PANTONE Emulation:** You can turn HP Professional PANTONE Emulation on or off. Default: **On** (PostScript and PDF jobs only).

---

## 9 Practical printing examples

- [Print a draft for revision with the correct scale](#)
- [Print a PDF multipage job from Adobe Acrobat Reader or Adobe Acrobat Pro](#)
- [Print a document with the correct colors](#)
- [Print a project](#)
- [Print a presentation](#)
- [Print and scale from Microsoft Office](#)

# Print a draft for revision with the correct scale

This section demonstrates how to print a draft for revision with the correct scale from Adobe Acrobat.

## Using Adobe Acrobat

1. In the Acrobat window, bring the mouse cursor to the bottom left corner of the document pane to check the page size.

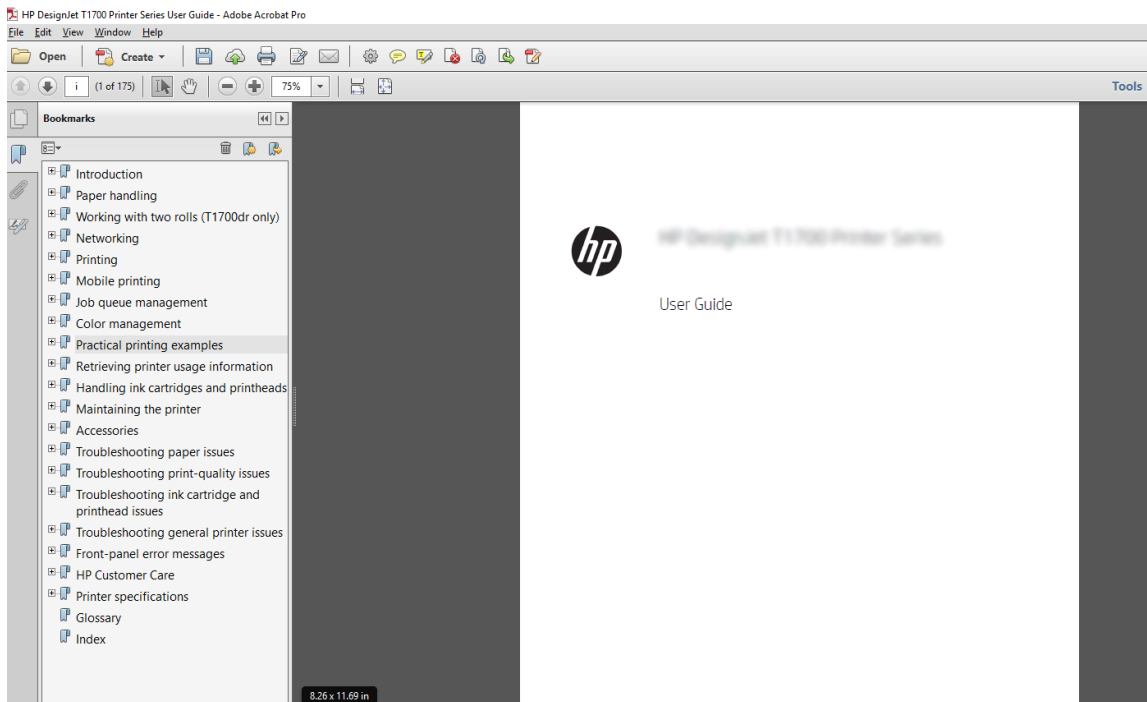

2. Select **File > Print** and ensure that **Page Sizing & Handling** is set to **Actual size**.

 **NOTE:** The page size will **not** be automatically selected according to the drawing size.

3. Click the **Properties** button and then select the **Paper/Quality** tab.
4. Choose whatever **Document Size** and **Print Quality** you want to use. If you want to define a new custom paper size, click the **Custom** button.

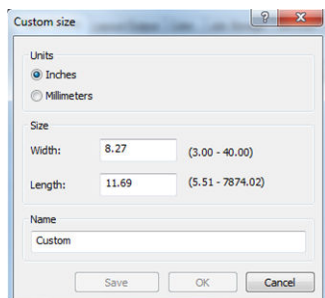

5. Select the **Features** tab, and then **Autorotate**.
6. Click **OK**, and check that the print preview in the **Print** dialog box seems correct.

# Print a PDF multipage job from Adobe Acrobat Reader or Adobe Acrobat Pro

## Using a raster driver

1. Open a multipage job in Adobe Acrobat Reader or Adobe Acrobat Pro (HP recommends always using the latest version).
2. Click **File > Print**.
3. Select the printer and driver.
4. Check the **Choose paper source by PDF page size** box.

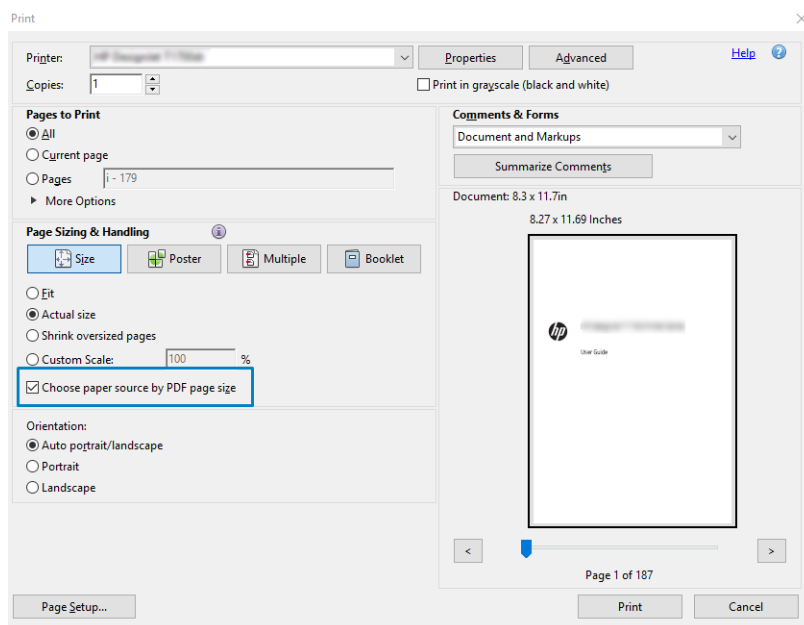

5. Adjust other properties in the driver properties window, as required.
6. Click the **Print** button.

The pages will be printed on the standard page size closest to the page size in the original document.

## Using a PostScript driver

1. Open a multipage job in Adobe Acrobat Reader or Adobe Acrobat Pro (HP recommends always using the latest version).
2. Click **File > Print**.
3. Select the printer and driver.

4. Check the **Choose paper source by PDF page size** and **Use custom paper size when needed** boxes.

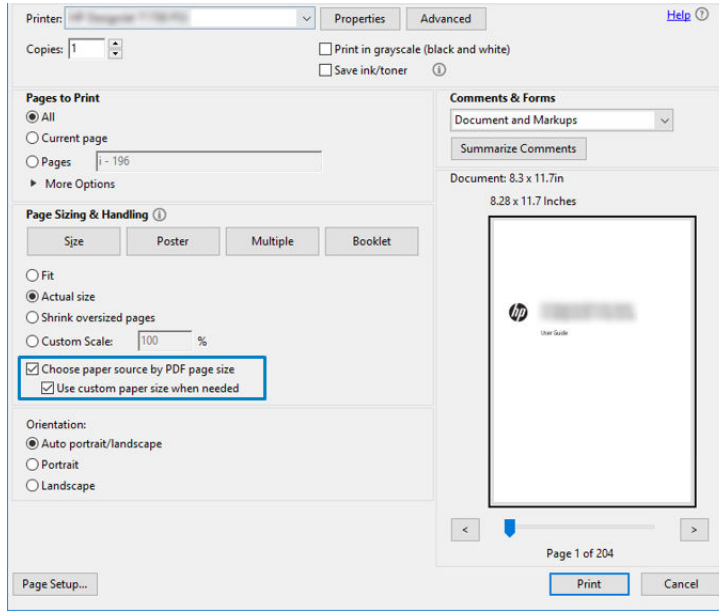

5. Adjust other properties in the driver properties window, as required.
6. Click the **Print** button.

If you checked the **Use custom paper size when needed** box, the pages will be printed on paper sizes corresponding to the page sizes in the original document.

## Using a PDF driver

With the latest versions of Adobe Acrobat Pro or Adobe Acrobat Reader, this is managed by the application, and the pages will be printed on paper sizes corresponding to the page sizes in the original document.

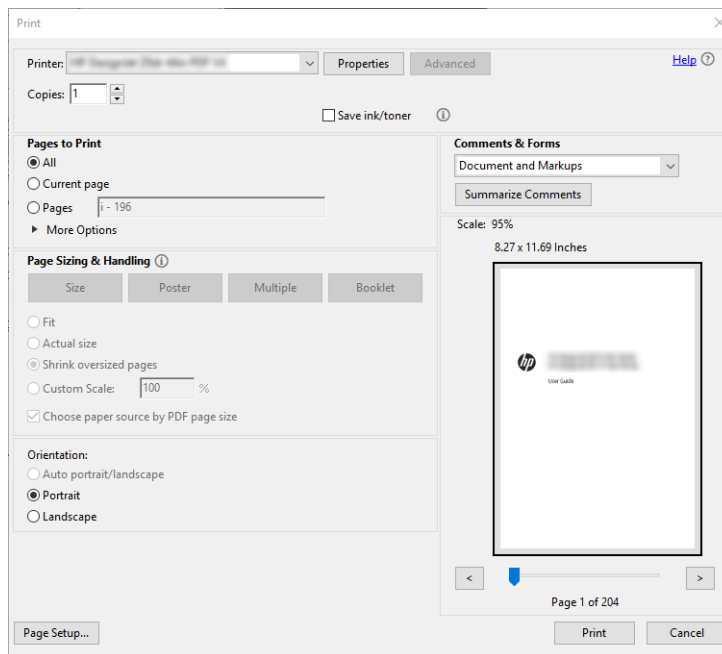



# Print a document with the correct colors

This section demonstrates how to print a document from Adobe Acrobat and Adobe Photoshop, with the emphasis on color management.

## Using Adobe Acrobat Reader

Acrobat Reader is the most basic application for PDF files; several color management tools common in more sophisticated applications are not explicitly present, and work by default with presets that cannot be changed. For example, there is no way to select a working color space; a default color space, most likely sRGB, is applied. This color space is used for screen display, for example. Also, as an alternative color profile when no other is specified by a file, as will be explained later.

The printing process is very simple.

1. Click **File > Print**.
2. Select the printer and driver from the **Printer** drop-down menu in the **Print** dialog box. Driver settings can be adjusted by clicking the **Properties** button.

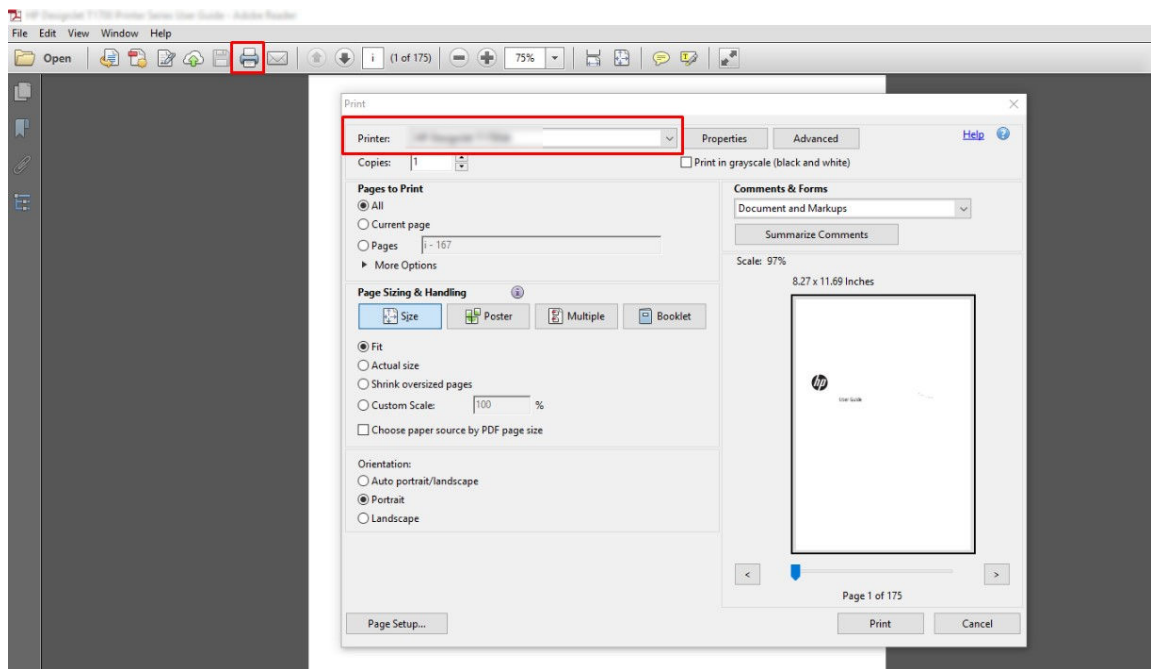

- Adjust the color settings in the driver properties window. Click the **Properties** button in the **Print** dialog and set the **Color** option in the **Color** tab. Check the box **Printer Managed Colors** and, if you have a V4 driver, select the most convenient source profile. Click **OK**.

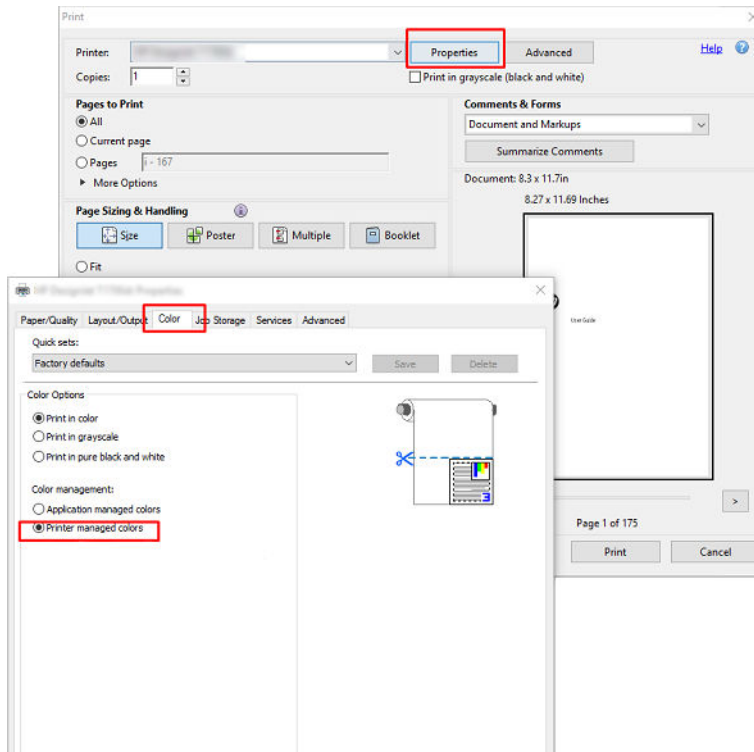

4. If you have a V3 driver, click the **Advanced** button in the Print dialog box to set color management options. Check the box **Let printer determine colors**.

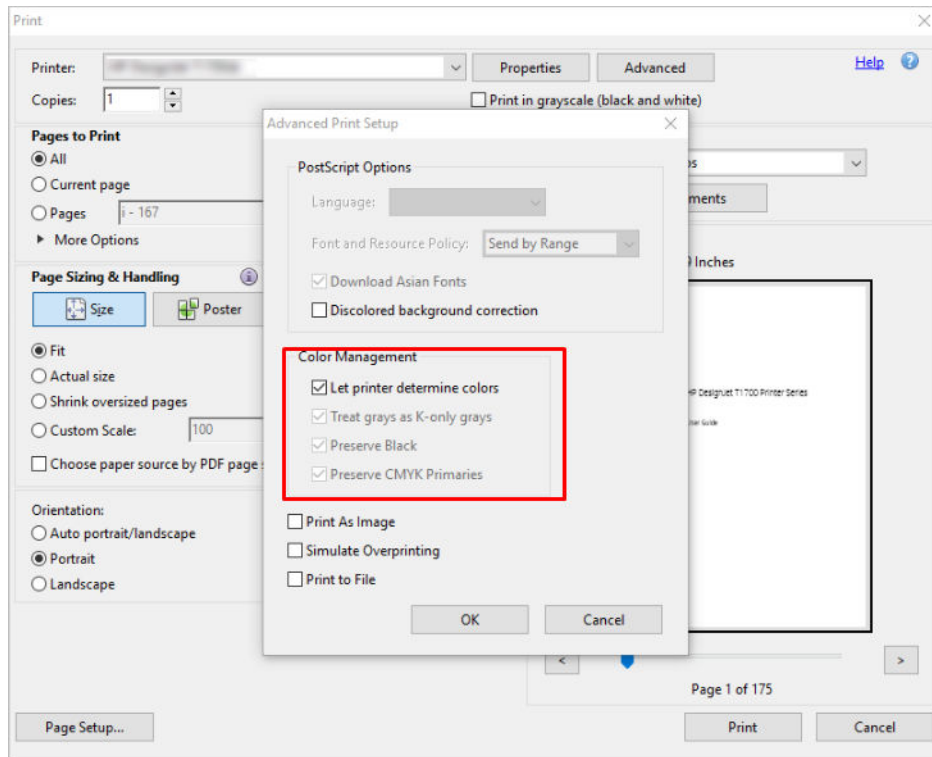

5. If the document contains several color profiles and you are not sure what the result will be, you can flatten the document first and print it as seen on the screen. To do this, check the box **Print As Image** in the Advanced Print Setup dialog box. In this case, the rasterization is performed by Acrobat Reader before calling the driver; whereas, if you do not check this box, the rasterization is performed by the driver. So checking the box may have a visible effect on the look of the printed document.

## Using Adobe Acrobat Pro

Acrobat Pro is a professional application that allows full color management. This section briefly describes the options to select a working color space, convert images to a desired color space, and print.

1. PDF files may not contain a color profile. In the absence of a color profile, Acrobat uses a working color space by default. To choose a working color space, first click **Edit > Preferences**.

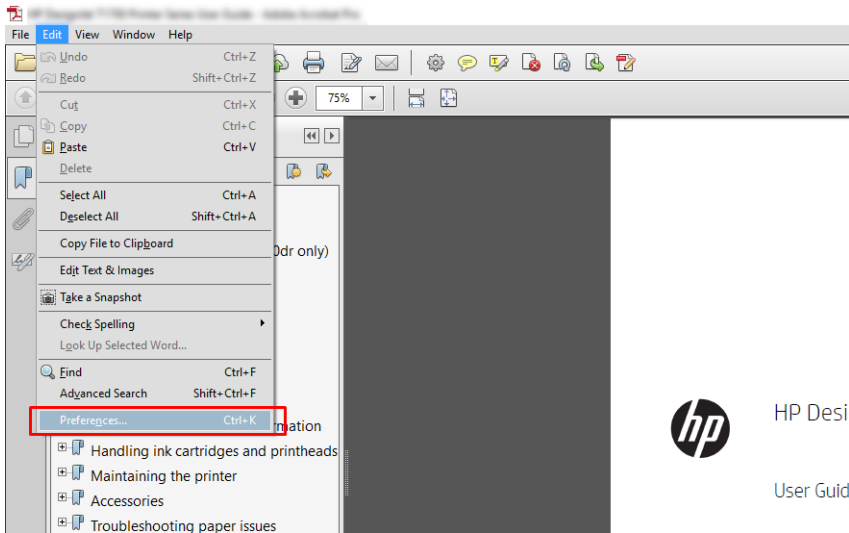

2. In the Preferences dialog box, you can choose RGB, CMYK, and grayscale working color spaces.

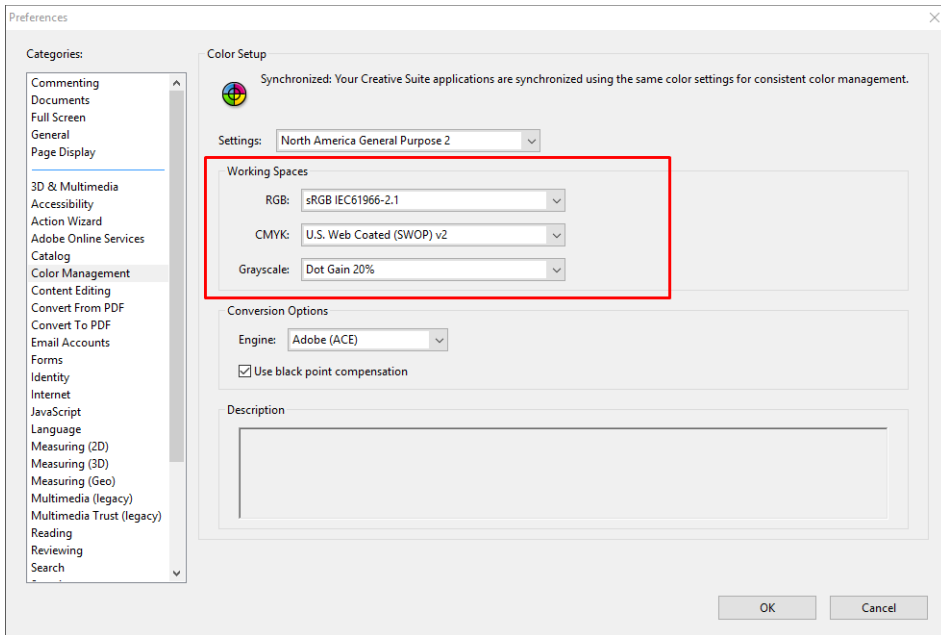

- PDF files can contain elements with different color profiles. Some may have color profiles, some may not. The working color space will affect only those without a color profile. If you want to attach a specific color profile to the document, you must convert the contents of the document as follows. First, select **Convert Colors** from **View > Tools > Print Production** or by clicking the icon in the status bar.

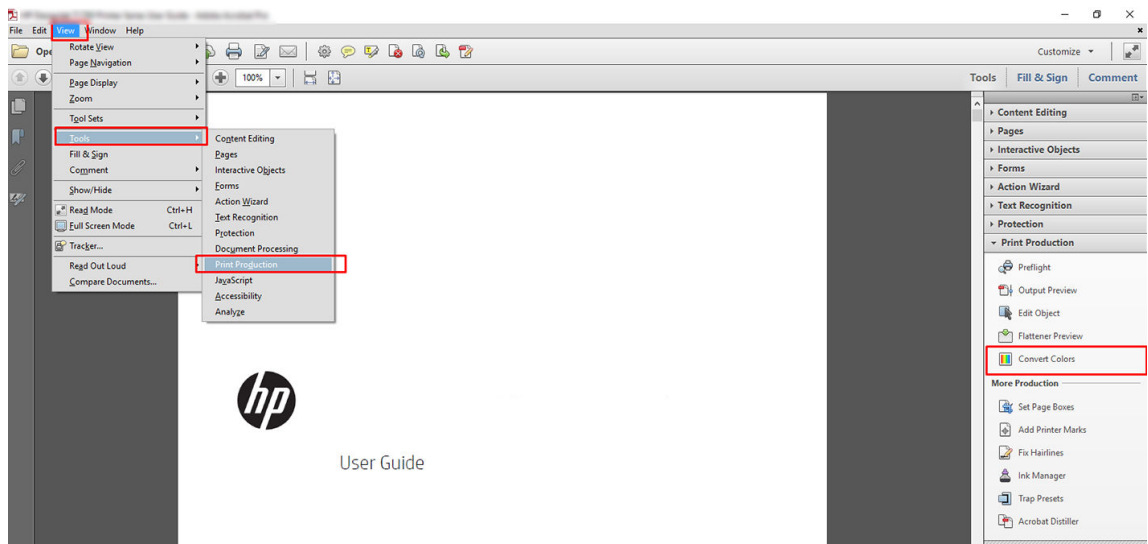

- Select the elements you want to convert by specifying matching criteria (object type and/or color type) and then the conversion attributes. If you want to change the embedded color profile, you can select **Any Object** and **Any Colorspace** in the Matching Criteria section. In the Conversion Attributes section you can choose, for example, to embed an Adobe RGB (1998) profile by selecting it as the **Conversion Profile**, checking the **Embed** box, clicking the **OK** button, and saving the file to keep the changes. The saved file will have an embedded Adobe RGB color profile.

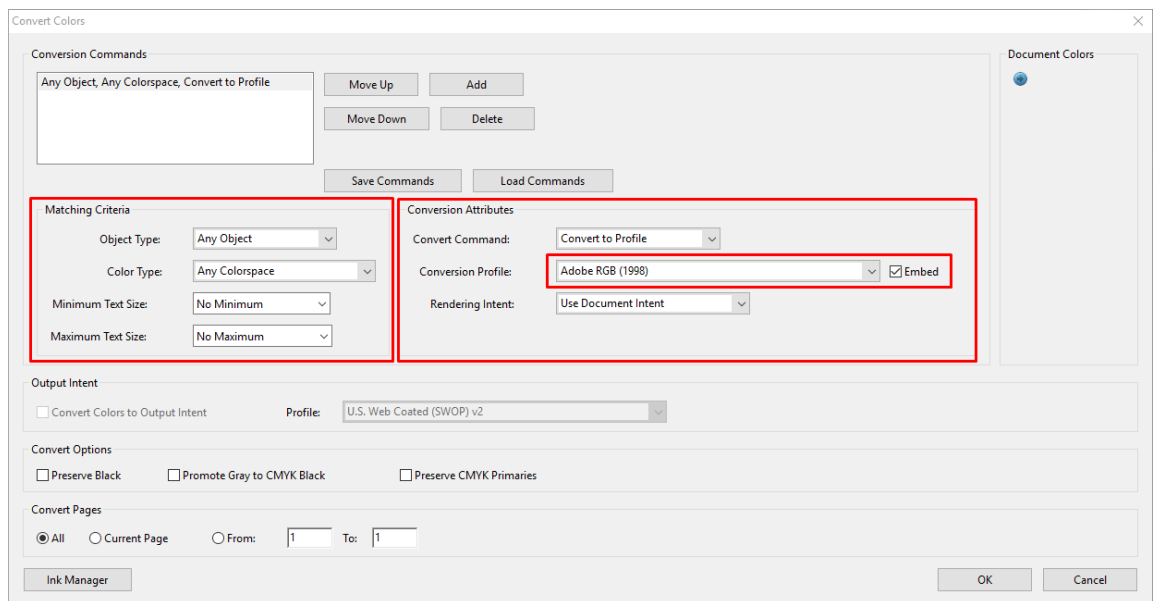

- To print the document, choose a printer from the Print dialog box, click the **Properties** button, and set the color options in the **Color** tab.

 **IMPORTANT:** Select **Print in color** and **Printer managed colors**.

If you use the V4 driver, you can also select a default color profile, which will be used for any elements that lack a color profile. HP suggests:

- sRGB or Adobe RGB (sRGB is the standard for most files)
- CMYK: Choose Coated FOGRA39 or US Web Coated (SWOP) v2.

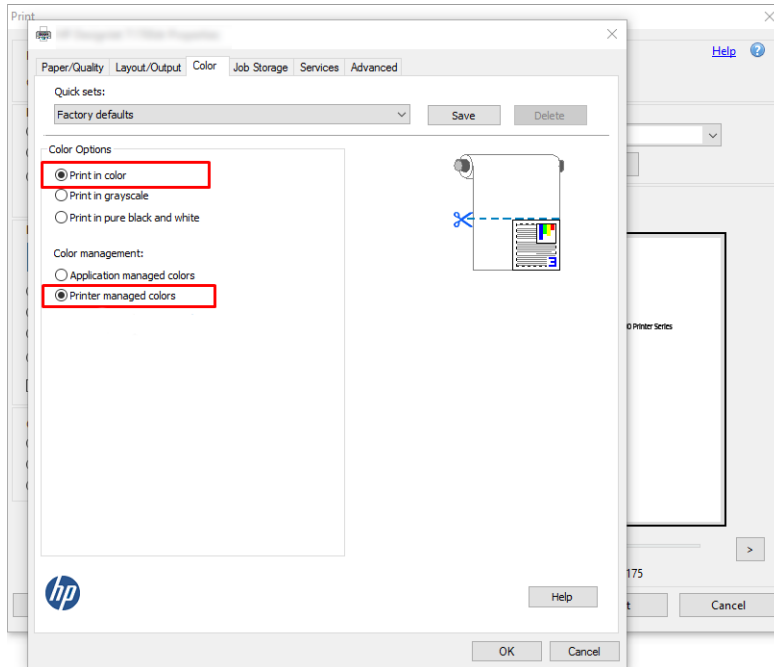

6. If you have a V3 driver, click the **Advanced** button in the Print dialog box, set **Color Handling** to **Printer Color Management**, and click **OK**.

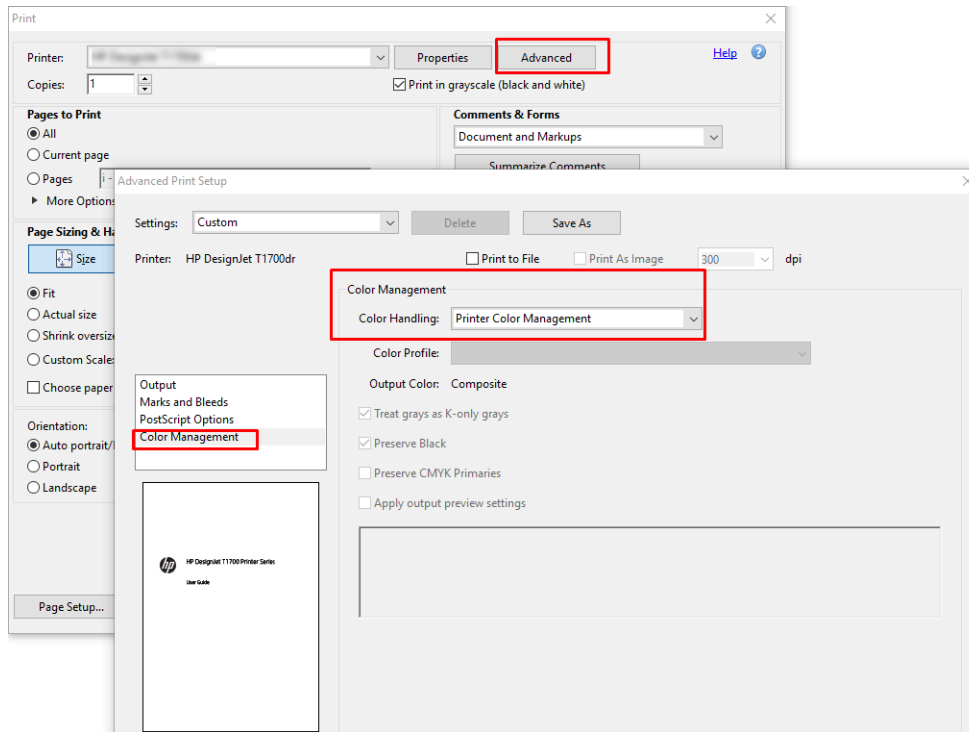

7. In the Print dialog box, click the **Print** button to print the document.

## Using Adobe Photoshop

1. In Photoshop, click **File > Print**, then select your printer.

2. In the Color Management section, set the Color Handling option to **Printer Manages Colors**.

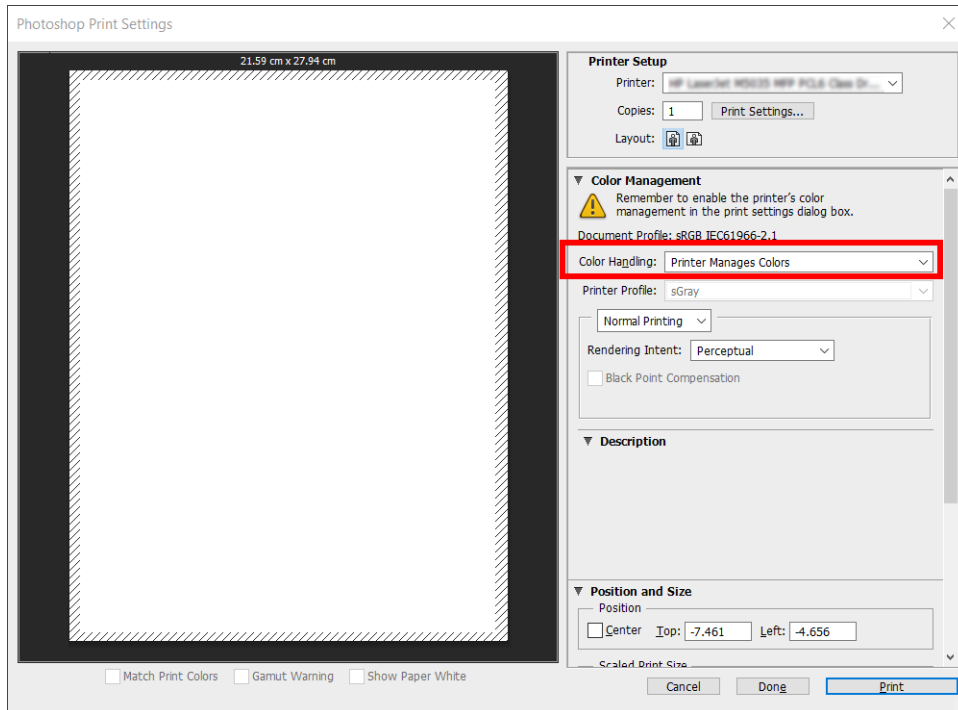

3. In the driver's **Color** tab, ensure that the color management option is **Printer managed colors**. This is the correct option because you have already selected **Printer Manages Colors** in Photoshop.

## Print a project

This section demonstrates how to print a project from AutoCAD.

### Using Autodesk AutoCAD

1. The AutoCAD window can show a model or layout. Normally a layout is printed rather than the model.



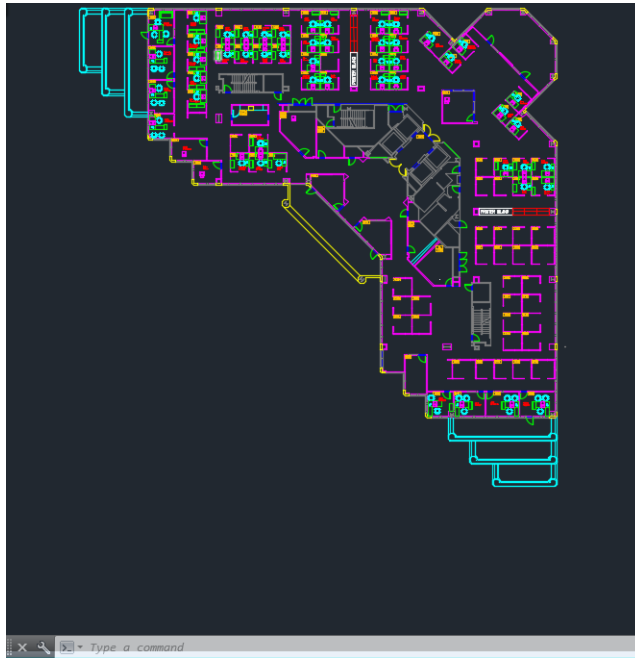

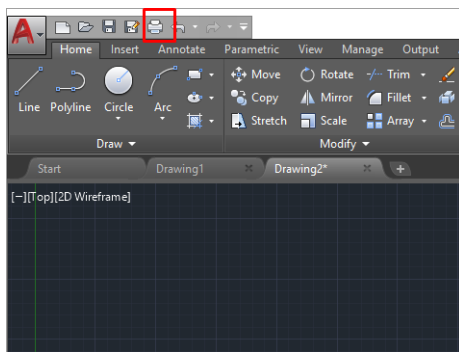

2. Click the Plot icon at the top of the window.

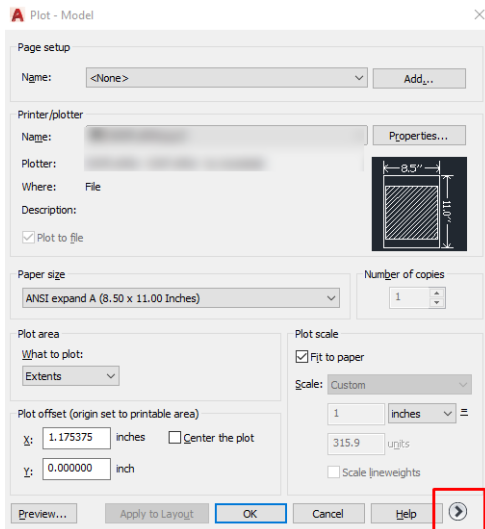

3. The **Plot** window opens.

4. You can see further options by clicking the circular button in the lower right corner of the window.



 **NOTE:** The Quality option here does not refer to the final print quality but to the quality of AutoCAD viewport objects that are sent for printing.

5. Select your printer and click the **Properties** button.
6. Select the **Device and Document Settings** tab, and click the **Custom Properties** button.

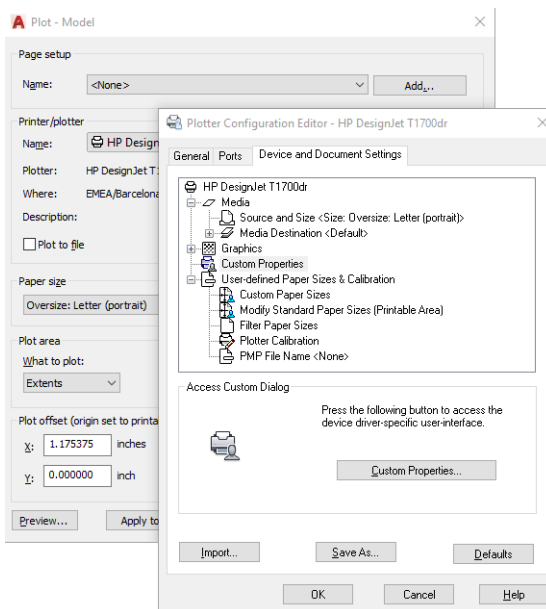

7. In the **Paper/Quality** or **Paper** tab, select the paper type that you intend to use.

 **NOTE:** If you select neither the paper source nor the paper type, the printer will not print on any protected roll (see [Protect a paper type \(T1600dr only\) on page 73](#)).

8. Select the print quality (your own choice between speed and quality of printing).
9. If you intend to print on roll paper, you must decide where the printer should cut the paper.

- With a Windows V3 driver: Click the **Paper/Quality** tab, then the Margins/Cutter **Settings** button, and select **Clip content by margins**.
- With a Windows V4 driver: Click the **Layout** tab; then, in the Layout Mode area, select **With margins** > **Clip content by margins**.

You can also adjust the crop lines, which indicated where to cut the paper after printing.

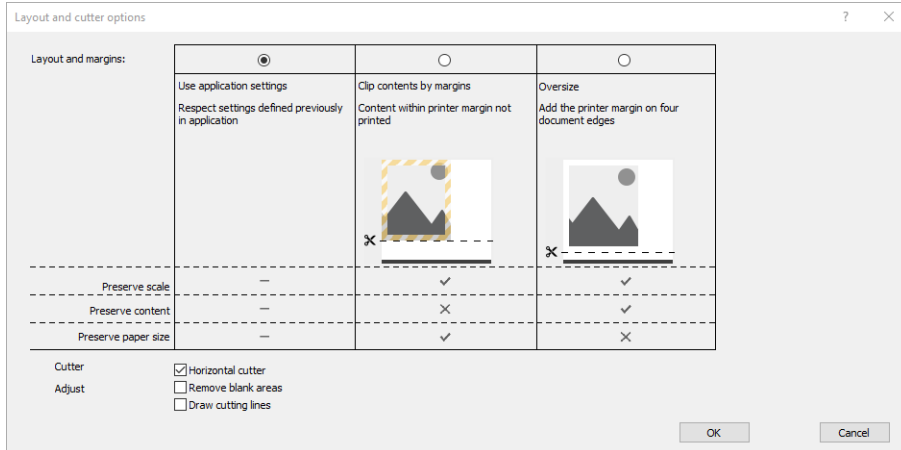

10. Select the **Layout/Output** tab, then select the **Autorotate** option. Autorotation can help to avoid wasting paper.
11. Click the **OK** button and save your configuration changes to a PC3 file.
12. When you have clicked the **OK** button in the Plot window, the printer will construct a print preview.

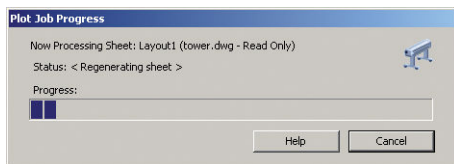

## Using clip contents by margins

You can select this margins option from **Advanced settings** > **Paper** > **Layout/Margins** > **Print with margins** > **Layout** > **Clip contents by margins**.

Use this option when the contents to be printed have white borders and a size equal to that of the paper you have selected. The printer will use the white border for its margins and you will get a page of size equal to that which is selected in the driver.

## Print a presentation

This section demonstrates how to print a presentation from AutoCAD and from Photoshop.

### Using Autodesk AutoCAD

1. Open the AutoCAD file and select a layout.

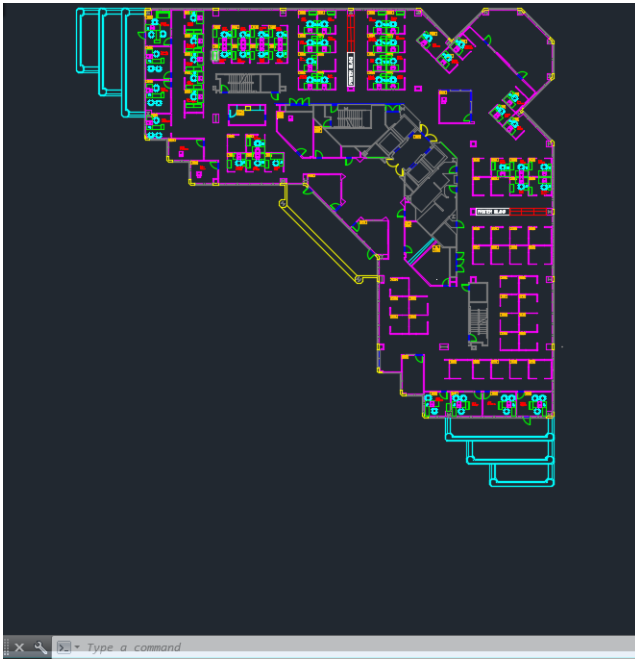

2. Click the Plot icon at the top of the window.

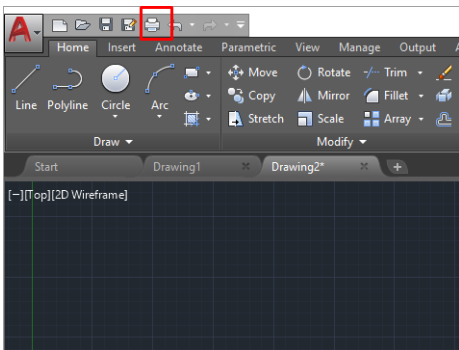

3. Ensure that the correct printer is selected, then click the **Properties** button.

4. Select the **Device and Document Settings** tab, and click the **Custom Properties** button.

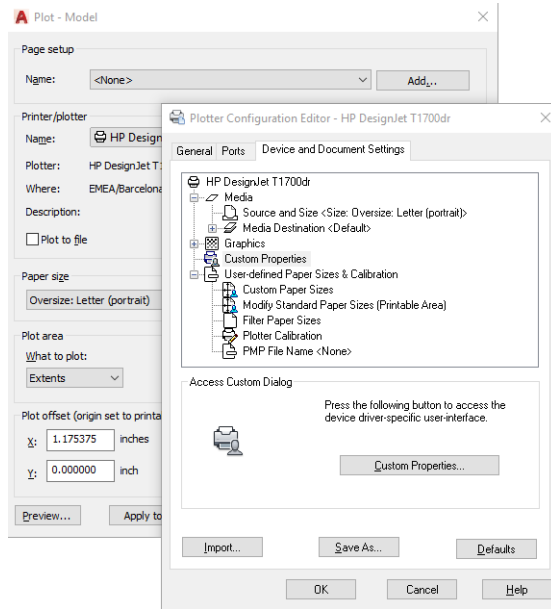

5. In the **Paper/Quality** tab, select the paper type that you intend to use.

**NOTE:** If you select neither the paper source nor the paper type, the printer will not print on any protected roll (see [Protect a paper type \(T1600dr only\) on page 73](#)).

6. Select the print quality (your own choice between speed and quality of printing).
7. If you intend to print on roll paper, you must decide where the printer should cut the paper.
  - With a Windows V3 driver: Click the **Paper/Quality** tab, then the Margins/Cutter **Settings** button, and select **Clip content by margins**.
  - With a Windows V4 driver: Click the **Layout** tab; then, in the Layout Mode area, select **With margins** > **Clip content by margins**.

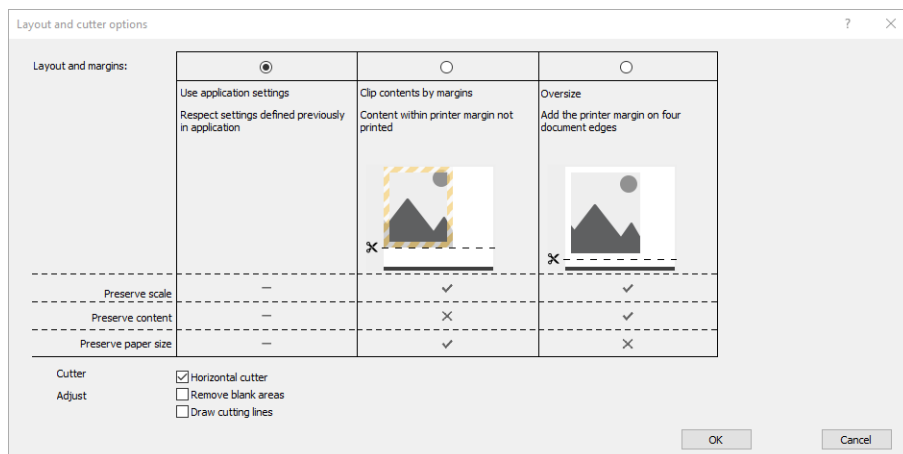

8. Select the **Layout/Output** tab, then select the **Autorotate** option. Autorotation can help to avoid wasting paper.
9. Click the **OK** button and save your configuration changes to a PC3 file.

10. When you have clicked the **OK** button in the Plot window, the printer will construct a print preview.

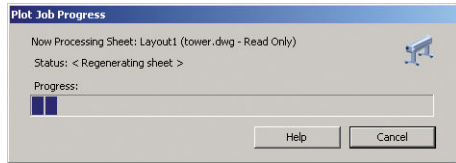

## Using Adobe Photoshop

1. In Photoshop, click **File > Print** and then select your printer.
2. Click **Print settings**, then select the **Paper/quality** tab.

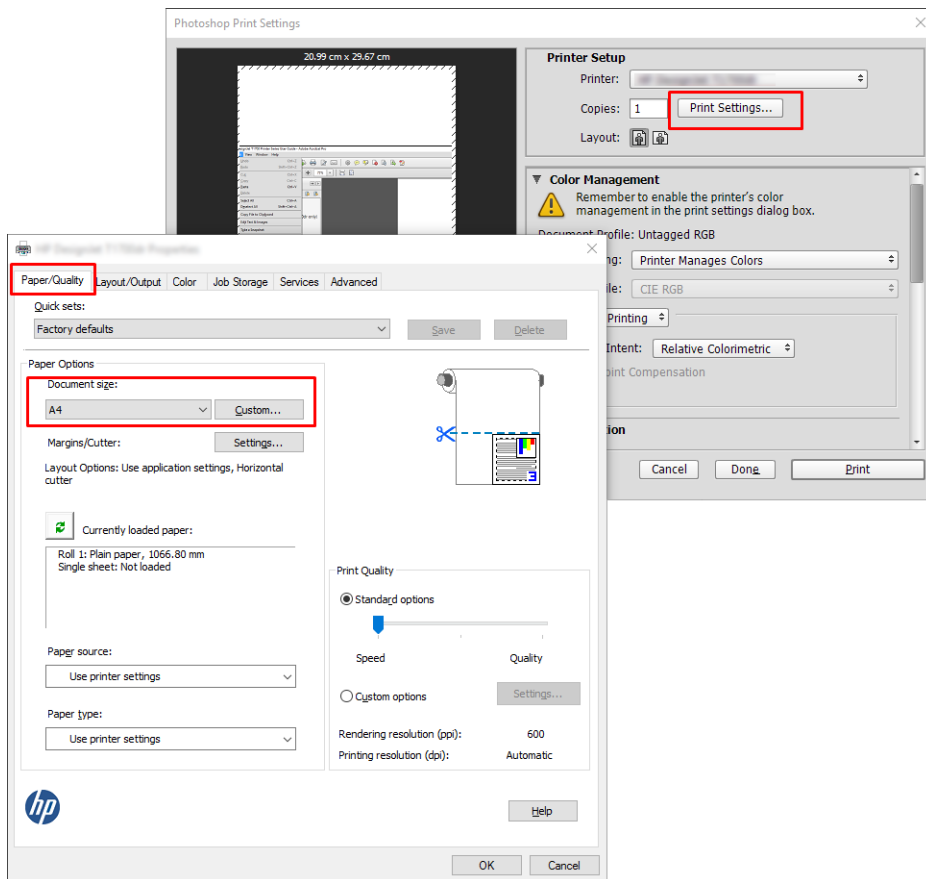

3. Choose from the available paper sizes.

If you do not find the paper size that you intend to use, click the **Custom** button. Enter the width, the length and the name of your custom paper size. Click the **Save** and **OK** buttons.

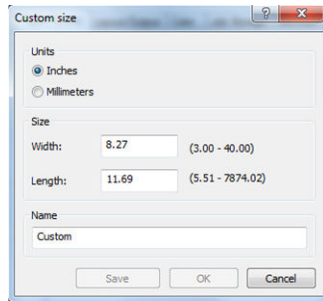

4. Select **Show preview before printing**. You may also wish to change the default paper source, paper type and print quality.
5. In the **Color** tab, the default color management option is **Printer managed colors**, and this is the correct option because you have already selected **Printer Manages Colors** in Photoshop.

## Print and scale from Microsoft Office

This section demonstrates how to print and scale from Microsoft Office 2013.

### Using Microsoft PowerPoint

1. Click **File > Print**, and select the name of your printer.

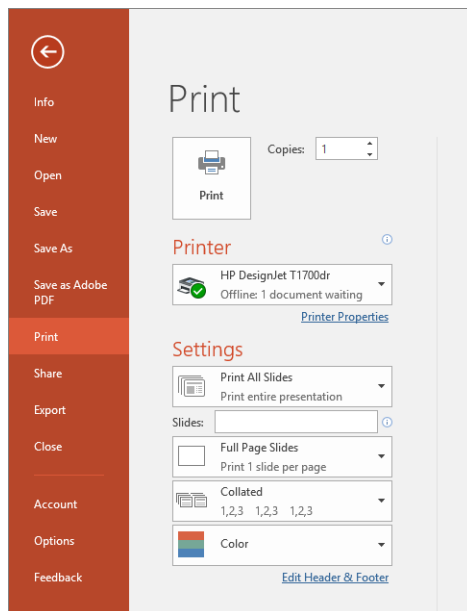

2. Click **Printer properties > Layout/Output > Resizing options** to scale the document to a particular size.
3. Select the **Paper/Quality** tab, then select **Paper Source** and **Paper Type**.
4. To clip contents by margins:

- With a Windows V3 driver: Click the **Paper/Quality** tab, then the Margins/Cutter **Settings** button, and select **Clip content by margins**.
- With a Windows V4 driver: Click the **Layout** tab; then, in the Layout Mode area, select **With margins > Clip content by margins**.

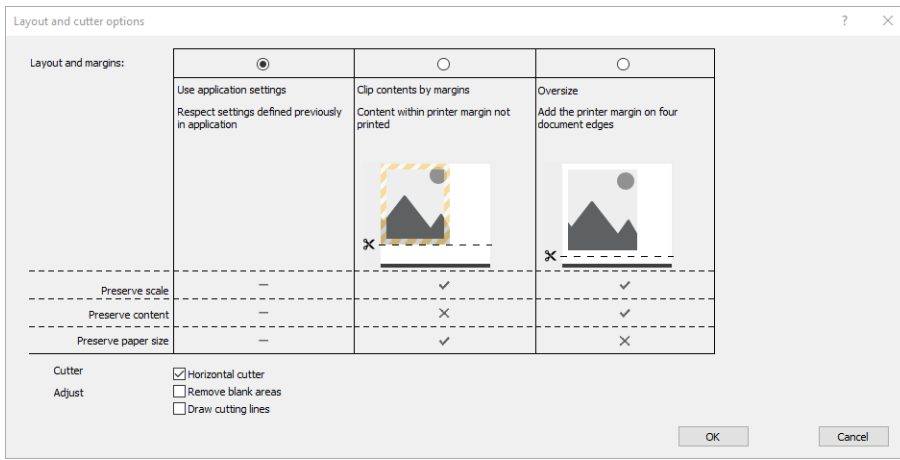

## Using Microsoft Project

1. Click **File > Print**.
2. Select your printer's name.
3. In the Settings section, you can choose the pages to print, the orientation, and the paper size.

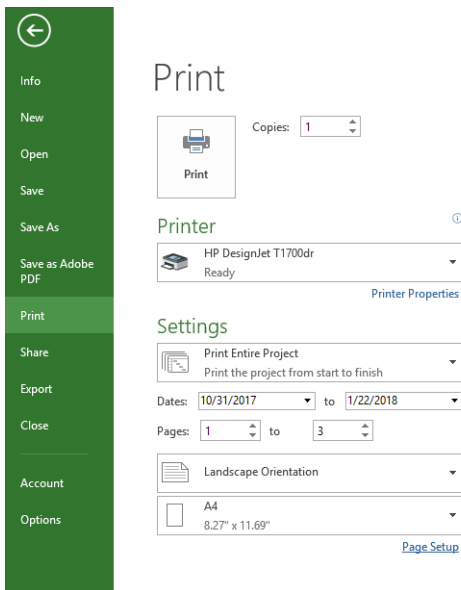



4. Click **Page Setup** to choose the **Paper Size** you want.

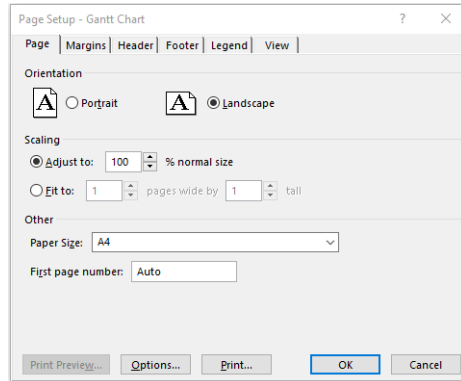

5. Select **Options** to go to the printer driver.

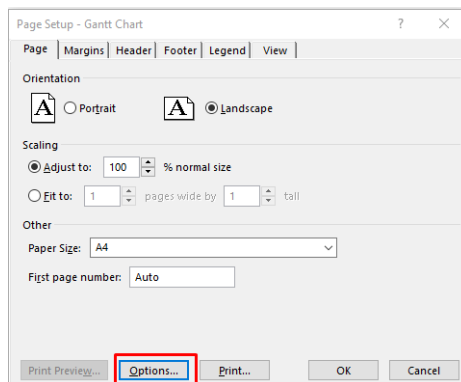

The default options in the **Paper/Quality** tab are probably suitable: **Paper source: Use printer settings** and **Paper Type: Use Printer Settings**.

6. Click **Layout/Output > Resizing options** to scale the document to a particular size. Alternatively, you can scale the document in Project.

## Using Microsoft Excel

1. Click **File > Print**. Select your printer's name, then click the back arrow to leave the **File** menu.
2. Select the **Page Layout** tab, then **Size**, and choose the paper size you want.

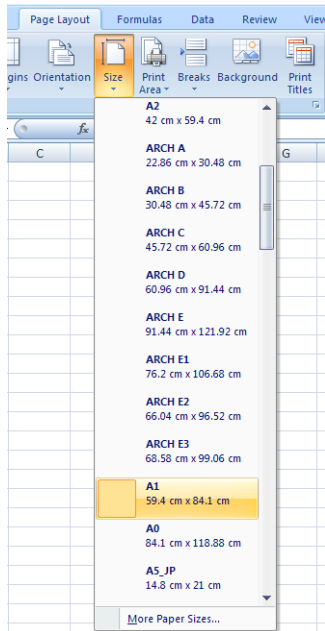

3. Click **File > Print > Printer properties** to go to the printer driver. In the **Paper/Quality** tab, select **Paper source**, **Paper Type** and **Print Quality**.
4. Click **Layout/Output > Resizing options** to scale the document to a particular size. Alternatively, you can scale the document in Excel.

# 10 Retrieving printer usage information

## Get printer accounting information

There are different ways of getting accounting information from your printer.

- View printer usage statistics for the whole lifetime of the printer, see [Check usage statistics on page 115](#).
- View ink and paper usage for each of your recent jobs, see [Check usage statistics for a job on page 117](#).
- Use a third-party application to request printer status, printer usage or job accounting data from the printer through the Internet. The printer provides data in XML to the application whenever requested. HP provides a Software Development Kit to facilitate the development of such applications.

## Check usage statistics

### Check usage from the front panel

Tap  on the front panel to display the usage information.

Print categories usage	Ink	Paper
Ink usage		↗
Paper area usage		↗
Paper length usage		↗

The following information can be retrieved:

- In the tab **Print categories usage**, you can see the ink, paper area, and paper length usage divided into categories:
  - Mono lines: Between 0% and 10% of non-white pixel coverage, printed on standard paper, with less than 1% of color pixel coverage
  - Color lines: Between 0% and 10% of non-white pixel coverage, printed on standard paper, with more than 1% of color pixel coverage
  - Low density image: Between 10% and 50% of non-white pixel coverage printed on standard paper

- High density image: Over 50% of non-white pixel coverage printed on standard paper
- Premium quality image: Any content type printed on premium paper
- Blueprint: Any content type printed on blueprint paper

- **Ink usage:** The ink consumed by each cartridge in ml, and the total amount of ink consumed.

CATEGORY	INK (ML)
Mono lines	0.92
Color lines	1.93
Low density image	0.86
High density image	431.09
Blueprint	n



- **Paper usage:** Amount of paper used and the total at the top, divided into paper categories or families.

Usage can be seen at each level.

CATEGORY	USED (M <sup>2</sup> )
Mono lines	0.22
Color lines	3.16
Low density image	0.51
High density image	17.45
Blueprint	n





When you tap , a message is displayed: **The usage report was sent to the job queue and will be printed soon.**

All the values can be displayed in English or metric units.

### Print the usage information

There are two different ways to print the usage information from the front panel's home screen:

- Tap  to launch the usage information screen, then tap the **Print usage report** button.
- Tap , then **Internal prints > User information prints > Print usage report**.

## Check usage from the Embedded Web Server

The same information can be retrieved from the Embedded Web Server as from the front panel.

1. Access the Embedded Web Server, see [Embedded Web Server on page 13](#).
2. In the menu at the side, click **Usage**.

The usage page shows all the printer usage information separated into various tables:

- **Summary:** The total ink usage and the total paper usage (in units of area and length).
- **Print categories usage:** The ink and paper usage and the number of pages printed for the different print categories (content type, such as mono lines, color lines, premium quality image, blueprint paper). This table information is shown only if the **Show application categories** printer setting is enabled. There are further conditions depending on the following settings:
  - The paper printed usage is shown if the **Paper area used and paper area printed** setting is enabled.
  - The blueprint category is shown if the **Enable the blueprint category** setting is enabled.
  - The premium quality image category is only shown if the **Enable the premium quality image category** setting is enabled.
  - If the printed-paper column information is shown, the paper area used field changes the string to "Paper area (m<sup>2</sup> used)". Otherwise, the string shown is "Paper area (m<sup>2</sup>)".
- **Ink usage:** The ink usage for the whole life of the printer (with approximate values). The ink consumption table lists the ink consumed in each color, ignoring the product number of the cartridge.
- **Paper usage:** All the papers that have been used throughout the life of the printer.

## Check usage statistics for a job



---

**NOTE:** The accuracy of the usage statistics is not guaranteed.

---

1. Access the Embedded Web Server, see [Embedded Web Server on page 13](#).
2. In the menu at the side, click **Usage > Accounting**.

The accounting page shows a table of the latest printed jobs, with the following information per job (not per page):

- **Name:** The name of the job

The job name is shown only if the **Show user name and job name in job accounting** setting is enabled for users under **Security > Security settings**.

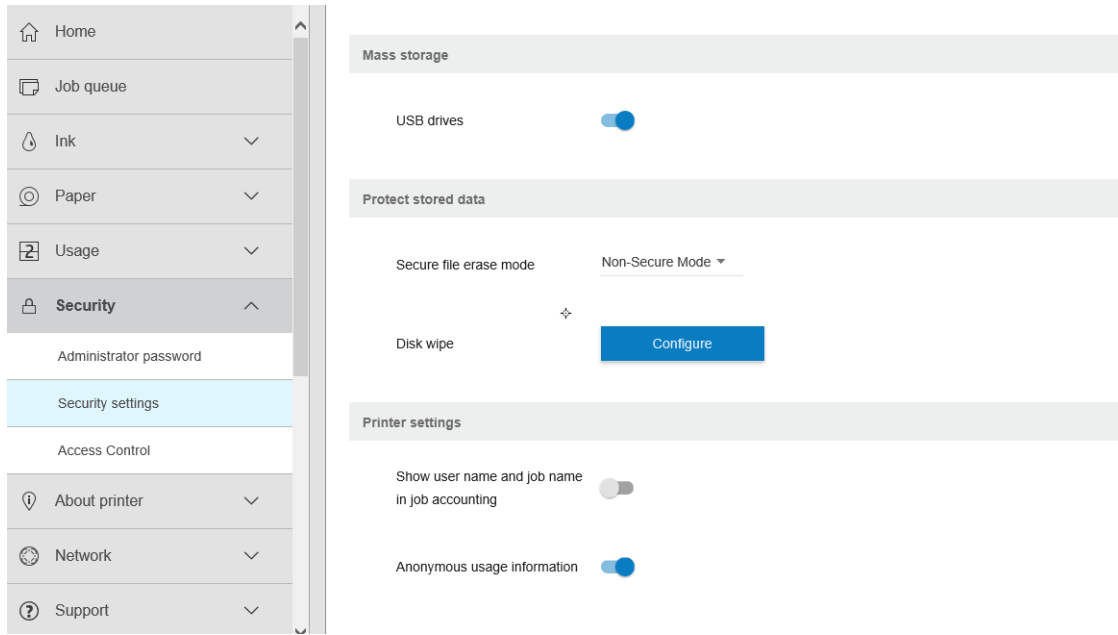

- **Number:** The number of the job
- **Time:** The date and time when the job was completed
- **User:** The name entered by the person who submitted the job (this item is present only if the corresponding security setting is enabled)

The user name is shown only if the **Show user name and job name in job accounting** setting is enabled for users under **Security > Security settings**.

- **Type:** The type of job (print)
- **Source:** The source of the job: USB, network, and so on
- **Print quality:** The print quality used to print the job
- **Copies:** The number of copies requested (cumulative after reprints)
- **Pages:** The number of pages completed
- **Status:** The status of the job: printed, canceled by user, and so on
- **Total cost:** The total cost of the job (visible if cost assignment is enabled)
- **Paper type:** The paper type used for the job
- **Paper area:** The used paper area of the job
- **Paper length:** The used paper length of the job
- **Ink used:** The volume of ink consumed by the job

A job is considered completed when all its pages have been printed, or canceled by the user, or canceled by the printer itself. An ongoing job (waiting for printing, being printed, being canceled, on hold for preview, and so on) will not appear on this list.

You can filter the jobs shown on the accounting page by using a drop-down control available on the same page. This control just changes the view, the job accounting information is not deleted in the printer. Essentially, this

page will report the last N jobs (or fewer if there are not enough completed jobs), where N is the value of this configuration parameter. By default, N is 10.

Two buttons appear in the accounting table:

- **Help:** This button opens a window displaying help information.
- **Export to CSV:** This button opens a window with a progress bar, and generates and downloads a CSV file. The downloaded file contains similar information to the accounting page, in CSV format. If the cost assignment is enabled, the CSV displays more detailed information about the cost of the job.

## Check cost assignment

---

 **NOTE:** The accuracy of the usage statistics is not guaranteed.

---

1. Access the Embedded Web Server, see [Embedded Web Server on page 13](#).
2. Go to the **Main** tab.
3. Click **Usage > Cost assignment configuration**.

The cost assignment page allows you to enable or disable the cost assignment setting, using the checkbox next to **Enable accounting assignment configuration** at the top of the page. If the setting is enabled, you can insert or modify the cost of the following sections.

---

 **NOTE:** At least one of these sections must be enabled in order to save the configuration.

---

- **Units**
  - **Currency:** Enter any three-letter currency code.
  - **Paper usage:** Select the units, English or metric.
- **Print categories cost:** Can be enabled or disabled. When enabled, you can assign a cost to each category, and select the units of the cost (per millimeter, or the option selected in the previous **Units** section). The cost is a number with two decimal digits of precision. Disabled categories are displayed grayed out.
- **Ink usage cost:** Can be enabled or disabled. Allows you to apply a cost to ink usage, and displays the available inks with a field to indicate the cost.
- **Paper usage cost:** Can be enabled or disabled. Allows you to apply a cost to the papers displayed. You can add papers from the list of supported papers. The costs can be removed or edited; they cannot be empty, but may be 0 (zero). The units selection is the same as for print categories.
- **Fixed cost:** Can be enabled or disabled. Allows you to add a fixed cost to all print, scan, and copy jobs.

Enabling the cost assignment setting causes the total cost column to appear in the accounting information, and detailed information is added to the exported CSV.

---

# 11 Handling ink cartridges and printhead

- [About the ink cartridges](#)
- [Check the ink cartridges status](#)
- [Remove an ink cartridge](#)
- [Insert an ink cartridge](#)
- [About the printhead](#)
- [Check the printhead status](#)
- [Remove the printhead](#)
- [Insert the printhead](#)
- [Storage of anonymous usage information](#)
- [Safe mode](#)



## About the ink cartridges

Ink cartridges store the ink and are connected to the printhead, which distributes the ink on the paper. To purchase additional cartridges, see [Supplies and accessories on page 137](#).

---

**⚠ CAUTION:** Observe precautions when handling ink cartridges because they are ESD-sensitive devices (see the [Glossary on page 192](#)). Avoid touching pins, leads and circuitry.

---

## Check the ink cartridges status

To view the ink levels of your ink cartridges, tap , then tap the cartridge that you want information on. There is a **Replace ink cartridges** option on the ink information page in case you want to do so (see also [Remove an ink cartridge on page 121](#)).

To get more information on your ink cartridges, you can press the color of the cartridge on which you want information.

You can also get this information from the HP Utility.

For an explanation of the ink cartridge status messages, see [ink cartridge status messages on page 174](#).

## HP Utility procedures

- In the HP DesignJet Utility for Windows, go to the **Overview** tab, each cartridge's status is under **Supplies Status > Cartridges**.

## Remove an ink cartridge

There are three occasions when you need to remove an ink cartridge.

- The ink cartridge is very low and you want to replace it with a full cartridge for unattended printing (you can use up the remaining ink in the first cartridge at a more convenient time).
- The ink cartridge is empty or faulty, and you must replace it to continue printing.
- You want to replace the printhead, and there is not enough ink left in the ink cartridge to complete the printhead replacement process. In this case, if the cartridge is not empty you can use it again later.

---

**⚠ CAUTION:** Do not try to remove an ink cartridge while printing.

**CAUTION:** Remove an ink cartridge only if you are ready to insert another one.

**CAUTION:** Make sure the printer wheels are locked (the brake lever is pressed down) to prevent the printer from moving.

**📝 NOTE:** When a cartridge runs out of ink, the current job is not automatically cancelled: unless you cancel it manually, it will resume printing when the empty cartridge has been replaced. If there is a delay in replacing the cartridge, you may see some banding on the print.

---

1. From the front panel, press , then , then **Replace**.

2. Open the ink cartridge cover on the left- or right-hand side of the printer.

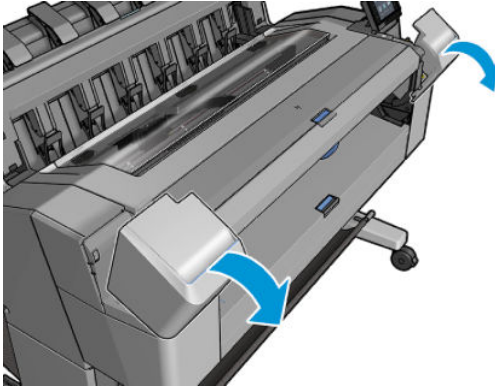

3. Grip the cartridge you wish to remove.

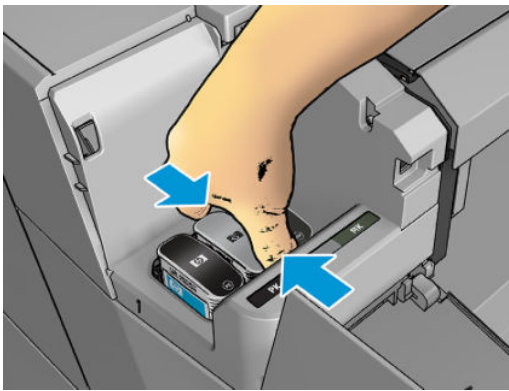

4. Pull the cartridge straight up.

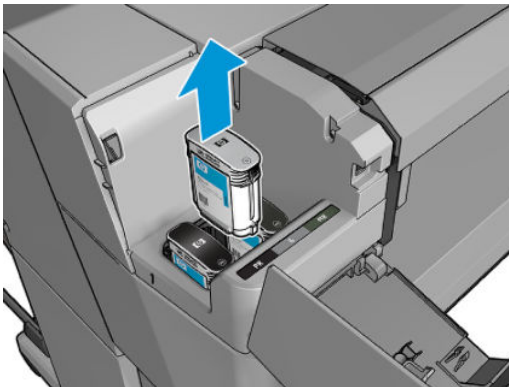

---

 **NOTE:** Avoid touching the end of the cartridge that is inserted into the printer, as there may be ink on the connection.

 **NOTE:** Avoid storing partially used ink cartridges.

---

5. The front-panel display identifies the missing ink cartridge.

## Insert an ink cartridge

1. Before removing the cartridge from its wrapping, shake it vigorously.



2. Unwrap the new ink cartridge, find the label identifying the ink color. Check that the letter or letters (in these illustrations, M for magenta) marking the empty slot, matches the letter or letters on the cartridge label.
3. Insert the ink cartridge into its slot: photo black, gray, and matte black on the left; cyan, magenta, and yellow on the right.

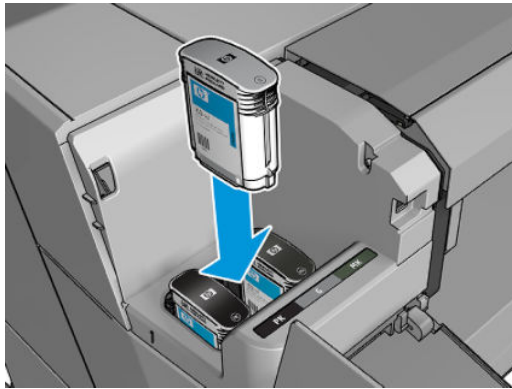

4. Push the cartridge into the slot until it snaps into position. You should hear a beep and see confirmation that the cartridge has been inserted.

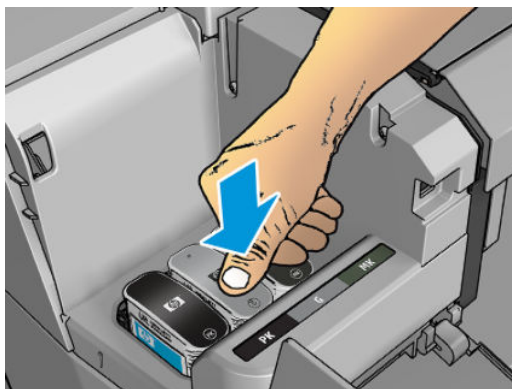

If you have difficulty, see [Cannot insert an ink cartridge on page 174](#).

5. When all cartridges have been inserted, close the cover.

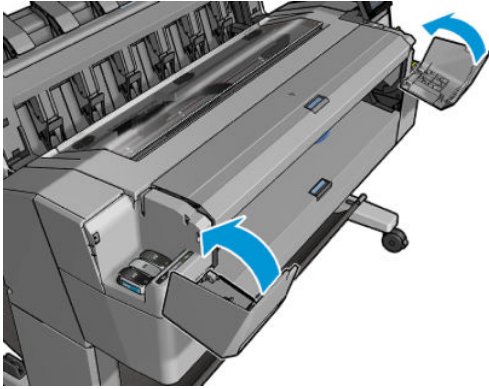

6. The front-panel display confirms that all cartridges have been correctly inserted.

Although it is possible to use non-HP ink cartridges, this choice has several serious disadvantages. It may not be possible to determine with enough accuracy the ink level or status of used, refilled, or counterfeit ink cartridges. Any service or repair required as a result is not covered under the warranty. System ink flushing, color calibration, and printhead alignment are recommended. If you experience print-quality problems, HP recommends changing to Original HP inks.

## About the printhead

The printhead is connected to the ink cartridges and jets ink onto the paper.

---

**⚠ CAUTION:** Observe precautions when handling the printhead because it is an ESD-sensitive device (see the [Glossary on page 192](#)). Avoid touching pins, leads, and circuitry.

---

## Check the printhead status

The printer automatically checks and services the printhead after each print. Follow the steps below to get more information on your printhead.

1. From the front panel, tap , then select the **Printhead** tab at the top of the window.
2. The front panel displays:
  - Product name
  - Product number
  - Serial number
  - Status, see [Front-panel error messages on page 182](#)
  - Volume of ink it has used
  - Warranty status

You can also get some of this information from the HP Utility.

For an explanation of the printhead status messages, see [Printhead status messages on page 176](#).

If the warranty status is **See warranty note**, this indicates that expired ink is being used. If the warranty status is **Out of warranty**, this indicates that non-HP ink is being used. See the limited warranty document provided with your printer for details of the warranty implications.

## Remove the printhead

**CAUTION:** Make sure the printer wheels are locked (the brake lever is pressed down) to prevent the printer from moving.

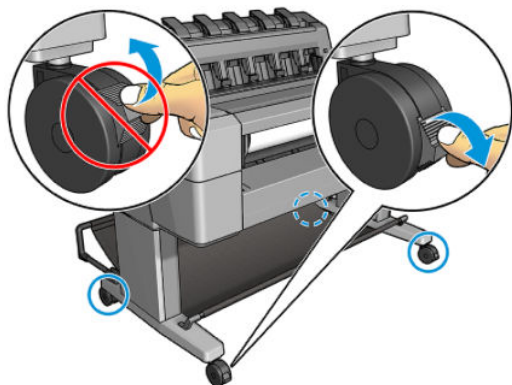

**CAUTION:** Printhead replacement must be performed with the printer powered on.

1. From the front panel, press , then select the **Printhead** tab, then **Replace**.

The front panel may ask whether the replacement printhead is new or used.

**NOTE:** You can cancel the process at any time by pressing .

2. The front panel asks you to open the window.

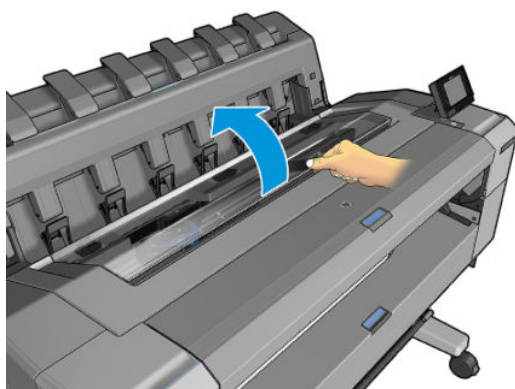

3. The carriage moves automatically to the left side of the printer.

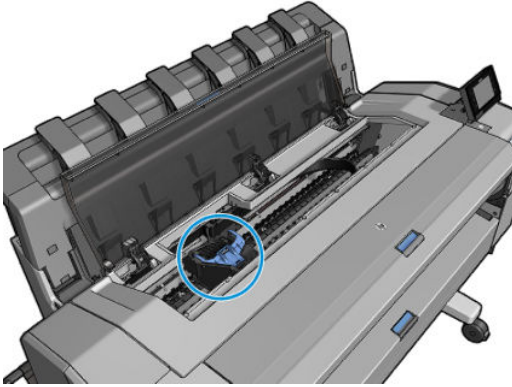

---

**⚠ CAUTION:** If the carriage is left in the removal position for more than three minutes without inserting or removing the printhead, it tries to move back to its normal position in the right-hand end.

---

4. Raise the blue printhead cover.

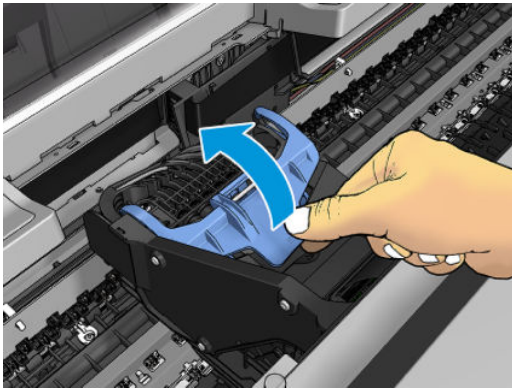

5. Pull the blue cover back towards you, raising the black piece to which it is attached.

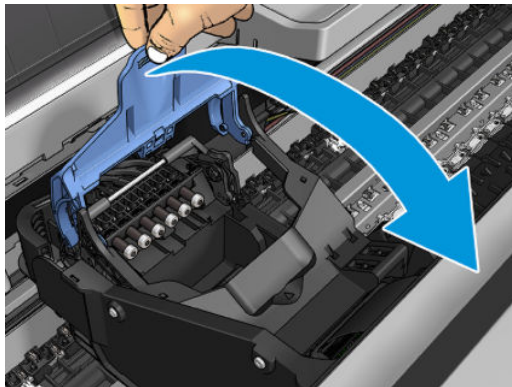
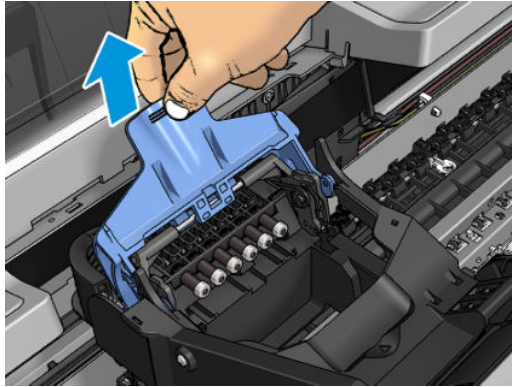

6. Leave the black piece approximately vertical.

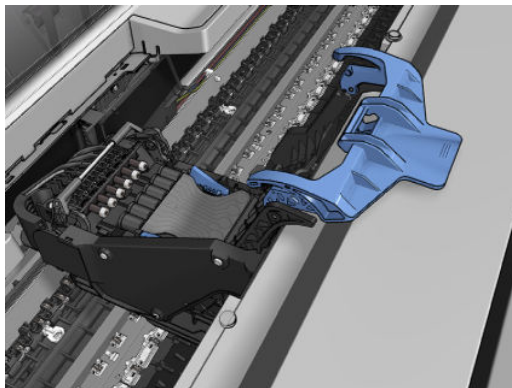

7. Grasp the printhead by the blue pieces on each side.

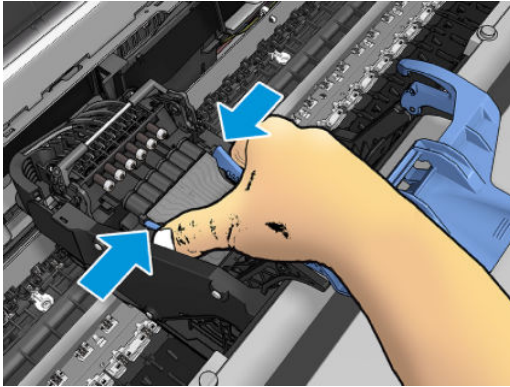

8. Lift the printhead out of the carriage.

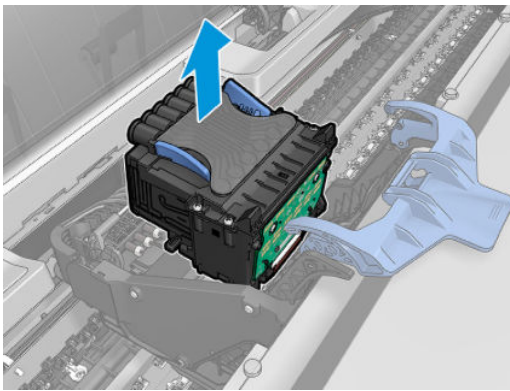

## Insert the printhead

 **NOTE:** You cannot insert a new printhead successfully if a connected ink cartridge has not enough ink to complete the printhead replacement process. In this case, you should replace the ink cartridge before inserting the new printhead. You can use the old cartridge later if it still contains some ink.

1. Remove the orange protective caps by pulling them down.



2. Insert the new printhead.

**⚠ CAUTION:** Insert the printhead slowly and vertically, straight down. It may be damaged if you insert it too fast, or at an angle, or if you rotate it as you insert it.

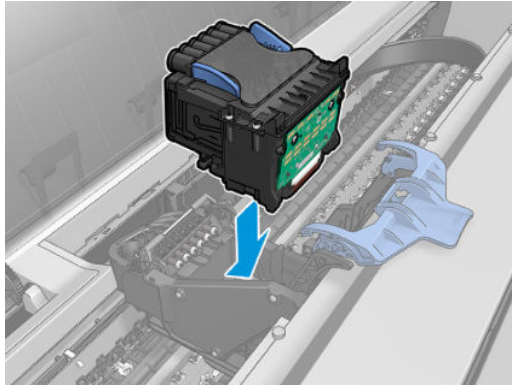

3. Check that the printhead is correctly aligned with its ink connectors.

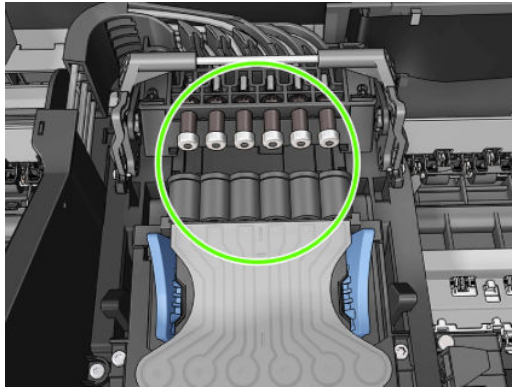

4. Lower the black piece over the printhead.

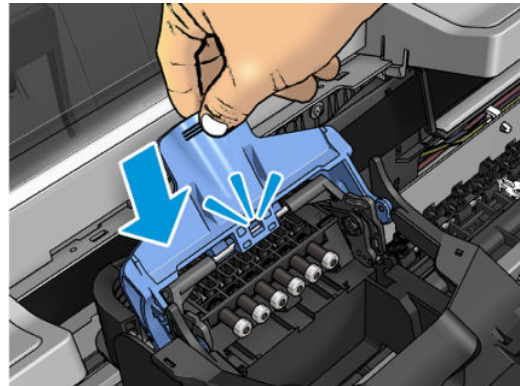
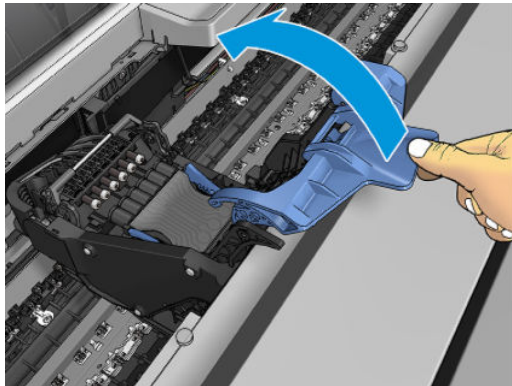

5. Close the blue cover and make sure that it is properly closed.

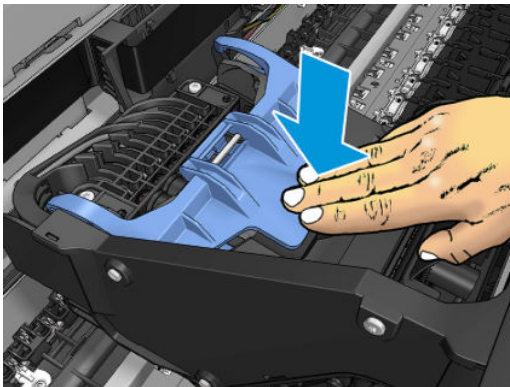
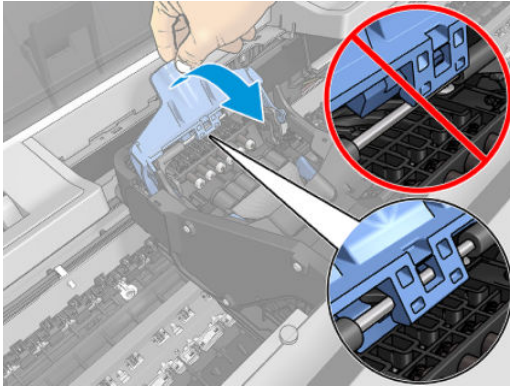

When the printhead has been inserted correctly and is accepted by the printer, the printer beeps.

---

 **NOTE:** If the printer does not beep when you insert the printhead and the **Replace** message appears on the front-panel display, the printhead may need to be reinserted.

---

6. Close the window.

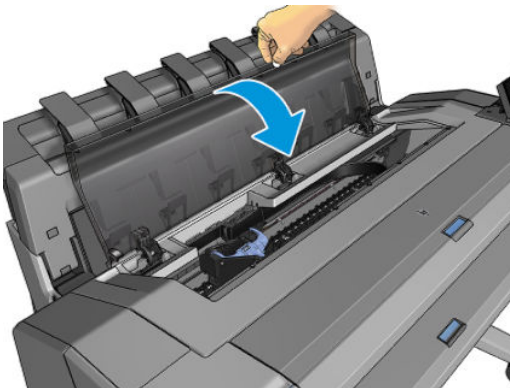

7. The front-panel display confirms that the printhead is correctly inserted. The printer starts checking and preparing the printhead. The default routine process takes 10 minutes. If the printer finds problems in preparing the printhead, it takes longer, up to 45 minutes. After the printhead is checked and prepared, the printhead realignment procedure runs automatically if paper is loaded, see [Align the printhead on page 175](#).
8. You are recommended to perform a color calibration after inserting a new printhead. See [Color calibration on page 88](#).

## Storage of anonymous usage information

Each ink cartridge contains a memory chip that assists in the operation of the printer. In addition, this memory chip stores a limited set of anonymous information about the usage of the printer, which can include the following: the date when the cartridge was first installed, the date when the cartridge was last used, the number of prints printed using the cartridge, the print coverage, the frequency of printing, the printing modes used, any printing errors that may have occurred, and the product model. This information helps HP to design future products to meet our customers' printing needs.

The information collected by the memory chip does not include information that could be used to identify a customer or user of the cartridge or printer.

HP collects a sample of the memory chips from ink cartridges returned to HP's free return and recycling program (HP Planet Partners: <http://www.hp.com/recycle>). The sampled memory chips are read and studied in order to improve future HP products.



HP partners who assist in recycling ink cartridges may also have access to the information. Any third party possessing the cartridge may be able to access the anonymous information on the memory chip.

If you are concerned about providing this anonymous information, you can tell the printer not to store the information in the memory chip. To do so, access the Embedded Web Server, and select **Security > Security Settings**, then in the **Printer Settings** section toggle to **Anonymous usage information**. This does not prevent the cartridge from working normally in other respects. However, if you change your mind later, you can restore the factory defaults to resume collecting printer usage information.

## Safe mode

Under certain conditions, including printer operation outside of environmental specifications, and when a used, refilled, or counterfeit ink cartridge has been detected, the printer will operate in safe mode. HP is unable to warrant the performance of the printing system when operated outside of environmental specifications or when a used, refilled, or counterfeit ink cartridge is installed. Safe mode is designed to protect the printer and the printheads from damage due to unexpected conditions, and is in operation when the icon is displayed on the printer's front panel and by the Embedded Web Server and HP Utility.

For optimal performance, use original HP ink cartridges. HP DesignJet printing systems, including original HP inks and printheads, are designed and engineered together to provide uncompromising print quality, consistency, performance, durability, and value—with every print.

- 
-  **NOTE:** This printer is not designed to use continuous ink systems. To resume printing, remove the continuous ink system and install genuine HP (or compatible) cartridges.
  -  **NOTE:** This printer is designed for ink cartridges to be used until they are empty. Refilling cartridges prior to depletion might cause your printer to fail. If this happens, insert a new cartridge (either genuine HP or compatible) to continue printing.
  -  **NOTE:** Dynamic security enabled printer. Only intended to be used with cartridges using an HP original chip. Cartridges using a non-HP chip may not work, and those that work today may not work in the future. More at: <http://www.hp.com/go/learnaboutesupplies>.
-

---

# 12 Maintaining the printer

- [Check printer status](#)
- [Clean the exterior of the printer](#)
- [Maintain the ink cartridges](#)
- [Move or store the printer](#)
- [Update the firmware](#)
- [Update the software](#)
- [Printer maintenance kits](#)
- [Secure File Erase](#)
- [Disk Wipe](#)

## Check printer status

You can check the current status of the printer in various ways:

- If you start the HP Utility and select your printer, you see a page of information describing the status of the printer and its paper and ink supplies.
- If you access the Embedded Web Server, you see information about the general status of the printer. The Supplies page in the **Main** tab describes the status of the paper and ink supplies.
- The front panel has 2 top-level screens that you can move between by sliding your finger across. The main screen provides direct access to the main printer functions. Swipe left to the widget page and see the status of ink and paper supplies.

If there are any current alerts, the upper row of the home screen shows the top-priority alert. Swipe down the dashboard to access the **Status Center** and take action.

## Clean the exterior of the printer

Clean the outside of the printer and all other parts of the printer that you regularly touch as part of normal operation with a damp sponge or a soft cloth and a mild household cleaner such as non-abrasive liquid soap.

---

 **WARNING!** To avoid an electric shock, make sure that the printer is turned off and unplugged before you clean it. Do not let water get inside the printer.

 **CAUTION:** Do not use abrasive cleaners on the printer.

---

## Maintain the ink cartridges

During the normal lifetime of a cartridge, no specific maintenance is required. However, in order to maintain the best print quality, replace a cartridge when it reaches its expiration date. The printer's front panel notifies you when any cartridge reaches its expiration date.

You can also check a cartridge's expiration date at any time: see [Check printer status on page 133](#).

See also [Handling ink cartridges and printhead on page 120](#).

## Move or store the printer

If you need to move or store the printer, prepare it correctly to avoid possible damage to it. To prepare the printer, follow the instructions below.

1. Do not remove the ink cartridges or printhead.
2. Make sure that no paper is loaded.
3. Make sure that the printer is idle.
4. Disconnect any cables connecting the printer to a network or a computer.
5. If the stacker seems likely to impede the movement of the printer through doorways, you can fold it out of the way by removing two screws.

If you need to leave the printer turned off for a long time, follow the additional steps below.

1. Turn off the power using the **Power** key on the front panel.
2. Disconnect the printer's power cable.

---

 **CAUTION:** If you turn the printer upside down, ink could escape into the printer and cause serious damage.

---

When reconnecting the power cable, remember to route the cable tidily along the back gutter.

When the printer is turned back on, it takes about three minutes to initialize itself and to check and prepare the printhead. Preparing the printhead normally takes just over a minute. However, if the printer has been off for a six weeks or more, preparing the printhead could take up to 45 minutes.

---

 **CAUTION:** If the printer remains off for a long period of time, the printhead may become unusable. In this case, you need to replace the printhead.

 **TIP:** Because preparing and purging the printhead uses both time and ink, you are strongly recommended to leave the printer always on or in sleep mode, whenever possible, to maintain the health of the printhead. In both cases, the printer wakes up from time to time to maintain the printhead. Thus, you can avoid going through lengthy preparation processes before using your printer.

---

## Update the firmware

The printer's various functions are controlled by firmware that resides in the printer.

From time to time firmware updates will be available from HP. These updates increase the printer's functionality, enhance its features, and may correct minor problems.

---

 **IMPORTANT:** You are strongly recommended to update the firmware periodically in order to take advantage of the latest developments.

---

There are various ways of downloading and installing firmware updates; you can choose whichever you find most convenient. They can be divided into two categories: automatic and manual updates.

### Automatic firmware updates

Automatic firmware updates are a convenience that is possible with Web-connected printers. Your printer can automatically download the latest firmware release and install it for you.

#### Important notes

- Your printer must be connected to the Internet; see [Set up printer services on page 15](#).
- To configure automatic firmware updates, you can use the front panel or the Embedded Web Server; see [Set up printer services on page 15](#).
- If an administrator password has been set, it will be required to change these settings.
- A firmware update package can be large; you may want to consider whether there are any implications for your network or Internet connection.
- A firmware update is downloaded in the background: the printer can be printing at the same time. However, it cannot be installed in the background: printing must stop.

### Manual firmware updates

Manual firmware updates can be performed in the following ways:

- Using the Embedded Web Server, select the **About Printer** tab and then **Manual Firmware Update**. If new firmware is available, some information about the new firmware is displayed, and you are given the opportunity to download and install it.
- Using the HP DesignJet Utility under Windows, select the **Admin** tab and then **Launch Firmware Update**.
- Using HP Web Jetadmin, with which you can make manual firmware updates or request automatic updates.
- Using a USB flash drive. Download the firmware file from <http://www.hp.com/go/DesignJetT1600/firmware> into the USB flash drive and insert it into the Hi-Speed USB host port in the front panel. A firmware update assistant will appear on the front panel to guide you through the update process.

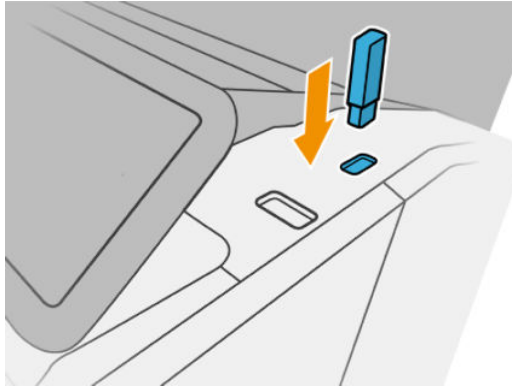

## Update the software

To update printer drivers and other software for your printer, go to <http://www.hp.com/go/DesignJetT1600/drivers>.

- Under Windows, HP Software Update regularly offers to update your software automatically, and the HP DesignJet Utility may offer you automatic updates when restarted.
- Under Mac OS X, Apple SW Update offers you software updates when available.

## Printer maintenance kits

Three maintenance kits are available for your printer, containing components that may need to be replaced after long use. When one of them is needed, a message is displayed on the front panel and by the HP Utility.

When you see the message, you should contact HP Support (see [Contact HP Support on page 185](#)) and request the maintenance kit. The kits are installed by service engineers only.

## Secure File Erase

The printer's hard disk is used as a temporary storage area for print jobs. Secure File Erase can erase your temporary files from the hard disk to protect them from unauthorized access. It begins to do so as soon as you turn it on, but old temporary files that were already on the hard disk are not erased retroactively. If you want to erase the old files too, see [Disk Wipe on page 136](#).

Secure File Erase provides three different levels of security:

- **Non-Secure:** all pointers to the information are erased. The information itself remains on the hard disk until the disk space it occupies is needed for other purposes, and it is then overwritten. While it remains on the

disk, it is difficult for most people to access, but may be accessed using software designed for the purpose. This is the normal method in which files are erased on most computer systems; it is the fastest method but the least secure.

- **Secure Fast Erase (1 pass):** all pointers to the information are erased, and the information itself is also overwritten with a fixed character pattern. This method is slower than Non-Secure, but more secure. It may still be possible to access fragments of the erased information by using special tools to detect residual magnetic traces.
- **Secure Sanitizing Erase (5 passes):** all pointers to the information are erased, and the information itself is repetitively overwritten using an algorithm designed to eliminate any residual traces. This is the slowest method, but the most secure. Secure Sanitizing Erase meets the US Department of Defense 5220-22.m requirements for clearing and sanitization of disk media. This is the default security level when using Secure File Erase.

While files are being erased, the printer's performance may be affected.

Secure File Erase is one of the facilities provided by Web JetAdmin, which is HP's free Web-based print management software: see <http://www.hp.com/go/webjetadmin>.

If you have difficulty in using Secure File Erase from Web JetAdmin, please contact HP Support: see [Contact HP Support on page 185](#).

The Secure File Erase configuration can be changed from Web JetAdmin or the Embedded Web Server (**Setup > Security settings**).

## Disk Wipe

Disk Wipe is the same as Secure File Erase (see [Secure File Erase on page 135](#)), except that it erases all temporary files, including old ones.

The Disk Wipe configuration can be changed from Web JetAdmin or the Embedded Web Server (**Setup > Security settings**).



---

**NOTE:** If you choose to erase the whole hard disk, you may be asked to restart the printer several times during the process, which will take about 6 hours with Secure Fast Erase or 24 hours with Secure Sanitizing Erase.

---



---

# 13 Supplies and accessories

- [How to order supplies and accessories](#)
- [Introduction to the accessories](#)

## How to order supplies and accessories

There are two alternative ways to order supplies or accessories:

- Visit <http://www.hp.com>, select your printer and click on the accessories button.
- Contact HP Support (see [Contact HP Support on page 185](#)), and check that what you want is available in your area.

The rest of this chapter lists the available supplies and accessories, and their part numbers, at the time of writing.

### Order ink supplies

The following ink supplies can be ordered for your printer.

#### Ink cartridges

Cartridge	Part number
HP 730 130-ml Cyan DesignJet Ink Cartridge	P2V62A
HP 730 130-ml Magenta DesignJet Ink Cartridge	P2V63A
HP 730 130-ml Yellow DesignJet Ink Cartridge	P2V64A
HP 730 130-ml Matte Black DesignJet Ink Cartridge	P2V65A
HP 730 130-ml Gray DesignJet Ink Cartridge	P2V66A
HP 730 130-ml Photo Black DesignJet Ink Cartridge	P2V67A
HP 730 300-ml Cyan DesignJet Ink Cartridge	P2V68A
HP 730 300-ml Magenta DesignJet Ink Cartridge	P2V69A
HP 730 300-ml Yellow DesignJet Ink Cartridge	P2V70A
HP 730 300-ml Matte Black DesignJet Ink Cartridge	P2V71A
HP 730 300-ml Gray DesignJet Ink Cartridge	P2V72A
HP 730 300-ml Photo Black DesignJet Ink Cartridge	P2V73A

#### Printhead

Printhead	Part number
HP 732 Printhead	B3P06A

### Order paper

The following paper types are currently provided for use with your printer.



**NOTE:** This list is likely to change over the course of time. For the latest information, see <http://www.hp.com>.



**NOTE:** Paper types that HP does not support may nevertheless be compatible with your printer.

Key to availability:

- (A) indicates papers available in Asia (excluding Japan)
- (C) indicates papers available in China
- (E) indicates papers available in Europe, the Middle East and Africa
- (J) indicates papers available in Japan
- (L) indicates papers available in Latin America
- (N) indicates papers available in North America

If the part number is not followed by parentheses, the paper is available in all regions.

### Roll paper

Paper type	g/m <sup>2</sup>	Length	Width	Product number
<b>HP Bond and Coated Paper</b>				
HP Super Heavyweight Plus Matte Paper	210	30.4 m (100 ft)	610 mm (24 in)	Q6626B (ELN)
			914 mm (36 in)	Q6627B (AELN)
HP Universal Bond Paper	80	45.7 m (150 ft)	594 mm (23.39 in) (A1)	Q8003A (AJ)
			610 mm (24 in)	Q1396A
				SA025A (2 Pack) (J)
			914 mm (36 in)	Q1397A
		91.4 m (300 ft)	594 mm (23.39 in) (A1)	Q8004A (EAJ)
			840 mm (33.11 in) (A0)	Q8005A (EAJ)
			914 mm (36 in)	C6810A
HP Bright White Inkjet Paper	90	45.7 m (150 ft)	419 mm (16.5 in)	Q1446A (EJ)
			594 mm (23.4 in) (A1)	Q1445A (EJ)
			610 mm (24 in)	C1860A (LN)
			610 mm (24 in)	C6035A (EAJ)
			840 mm (33.11 in) (A0)	Q1444A (EAJ)
			914 mm (36 in)	C6036A (EAJ)
		914 mm (36 in)	C1861A (LN)	
91.4 m (300 ft)	914 mm (36 in)	C6810A		
HP Heavyweight Coated Paper	130	30.4 m (100 ft)	610 mm (24 in)	C6029C
			914 mm (36 in)	C6030C
HP Coated Paper	90	45.7 m (150 ft)	594 mm (23.4 in) (A1)	Q1442A (AEJ)
			610 mm (24 in)	C6019B
			840 mm (33.11 in) (A0)	Q1441A (EJ)
			914 mm (36 in)	C6020B

Roll paper (continued)

Paper type	g/m <sup>2</sup>	Length	Width	Product number
		91.4 m (300 ft)	914 mm (36 in)	C6980A
HP Universal Coated Paper	90	45.7 m (150 ft)	610 mm (24 in)	Q1404B
			914 mm (36 in)	Q1405B
HP Universal Heavyweight Coated Paper	131	30.4 m (100 ft)	610 mm (24 in)	Q1412B
			914 mm (36 in)	Q1413B
<b>HP Technical Paper</b>				
HP Translucent Bond Paper	63	45.7 m (150 ft)	610 mm (24 in)	C3860A (LN)
			914 mm (36 in)	C3859A (AJLN)
HP Natural Tracing Paper	90	45.7 m (150 ft)	594 mm (23.4 in) (A1)	Q1439A (J)
			610 mm (24 in)	C3869A
			914 mm (36 in)	C3868A
<b>HP Film (Technical and Graphic)</b>				
HP Clear Film	174	22.8 m (75 ft)	610 mm (24 in)	C3876A
			914 mm (36 in)	C3875A
HP Matte Film	160	38.1 m (125 ft)	610 mm (24 in)	51642A
			914 mm (36 in)	51642B
HP Special Inkjet Paper	131	45.7 m (150 ft)	610 mm (24 in)	51631D (ELN)
			914 mm (36 in)	51631E
<b>HP Photographic Paper</b>				
HP Universal Gloss Photo Paper	200	30.4 m (100 ft)	610 mm (24 in)	Q1426B
			914 mm (36 in)	Q1247B
HP Universal Satin Photo Paper	200	30.4 m (100 ft)	610 mm (24 in)	Q1420B
			914 mm (36 in)	Q1421B
HP Universal Instant-dry Gloss Photo Paper	200	30.4 m (100 ft)	610 mm (24 in)	Q6574A
			914 mm (36 in)	Q6575A
HP Premium Instant-dry Gloss Photo Paper	235	30.5 m (100 ft)	610 mm (24 in)	Q7991A (AELN)
			914 mm (36 in)	Q7993A (AELN)
HP Universal Instant-dry Satin Photo Paper	200	30.4 m (100 ft)	610 mm (24 in)	Q6579A
			914 mm (36 in)	Q6580A
			60.9 m (200 ft)	Q8755A (AELN)
HP Premium Instant-dry Satin Photo Paper	235	30.5 m (100 ft)	610 mm (24 in)	Q7992A (AELN)
			914 mm (36 in)	Q7994A (AELN)
HP Premium Matte Photo Paper	210	30.4 m (100 ft)	610 mm (24 in)	CG459B

## Roll paper (continued)

Paper type	g/m <sup>2</sup>	Length	Width	Product number
			914 mm (36 in)	CG460B
<b>HP Self-Adhesive Material</b>				
HP Everyday Adhesive Matte Polypropylene	120	22.8 m (75 ft)	610 mm (24 in)	COF18A (AELN)
	168 with liner		914 mm (36 in)	COF19A (AELN)
HP Everyday Adhesive Matte Polypropylene, 3-in Core	120	30.5 m (100 ft)	914 mm (36 in)	D9R24A (ELN)
HP Everyday Adhesive Gloss Polypropylene	140	22.8 m (75 ft)	914 mm (36 in)	COF28A (AELN)
	190 with liner			
HP Universal Adhesive Vinyl	160	20 m (66 ft)	914 mm (36 in)	C2T51B (2 Pack) (ELN)
	300 with liner			
<b>HP Banner and Sign Material</b>				
HP Everyday Matte Polypropylene	120	30.4 m (100 ft)	610 mm (24 in)	CH022A
			914 mm (36 in)	CH023A (AELN)
			60.9 m (200 ft)	914 mm (36 in)
Media name: HP Everyday Matte Polypropylene, 3-in Core	120	61 m (200 ft)	914 mm (36 in)	D9R28A (ELN)
HP Premium Matte Polypropylene	140	22.9 m (75 ft)	914 mm (36 in)	C2T53A (ELN)
HP Durable Synthetic Banner	133	22.9 m (75 ft)	914 mm (36 in)	COF12A (LN)
HP Durable Synthetic Banner, 3-in Core	133	30.5 m (100 ft)	914 mm (36 in)	1AF09A (LN)
HP Opaque Scrim	495	30.5 m (100 ft)	610 mm (24 in)	Q8675C (LN)
			914 mm (36 in)	Q1898C (AELN)
HP Everyday Blockout Display Film	220	30.5 m (100 ft)	914 mm (36 in)	Y3Z17A (ELN)

## Order accessories

The following accessories can be ordered for your printer.

Name	Product number
HP USB 3.0 to Gigabit LAN Adapter	N7P47AA
HP DesignJet PostScript®/Pdf Upgrade Kit	CO666C
HP DesignJet 3-in Spindle Adaptor Kit	CN538A
HP DesignJet 36-in Spindle	L4R66A
HP HD Pro 42-in scanner	G6H51B
HP SD Pro 44-in scanner	G6H50B

# Introduction to the accessories

## PostScript Upgrade

The PostScript Upgrade enables a T1600 to print the same file types that a T1600 PS can print, including PDF and PostScript files. The PostScript upgrade can be plugged into the printer's USB host. It is not necessary to leave it permanently connected: just plug it in once, and the printer is upgraded forever.

## Spindle

With extra spindles, you can change rapidly from one paper type to another.

## 3-in Spindle Adaptor Kit

With this adaptor you can use paper rolls with 3-inch cores, provided that the diameter of the roll is within printer specifications.

---

# 14 Troubleshooting paper issues

- [Paper cannot be loaded successfully](#)
- [Paper type is not in the driver](#)
- [Printer printed on the wrong paper type](#)
- [Automatic cut not available](#)
- [On hold for paper](#)
- [The paper has jammed in the print platen](#)
- [The paper has jammed in the stacker](#)
- [The printer reports unexpectedly that the stacker is full](#)
- [A strip stays on the output tray and generates jams](#)
- [Printer displays out of paper when paper is available](#)
- [Prints do not fall neatly into the basket](#)
- [Sheet stays in the printer when the print has been completed](#)
- [Paper is cut when the print has been completed](#)
- [Cutter does not cut well](#)
- [Roll is loose on the spindle](#)
- [Recalibrate the paper advance](#)

## Paper cannot be loaded successfully

- Ensure that no paper is already loaded.
- Ensure that the paper is far enough inside the printer: you should feel the printer grab the paper.
- Do not attempt to straighten the paper during the aligning process, unless instructed to do so by the front-panel display. The printer automatically attempts to straighten the paper.
- The paper may be crumpled, or warped, or may have irregular edges.
- It can be difficult to insert a particularly stiff paper from the upper roll. Try moving it to the lower roll.

## Unsuccessful roll load issues

- If the paper does not load, the leading edge of the paper may not be straight or clean and needs to be trimmed. Remove the initial 2 cm (1 in) from the roll and try again. This may be necessary even with a new roll of paper.
- Ensure the roll ends are tight against the spindle ends.
- Check that the spindle is correctly inserted.
- Check that the paper is correctly loaded on the spindle. See [Load a roll onto the spindle on page 33](#).
- Check that all roll end plugs have been removed.
- Check that the paper is wound tightly on the roll.
- Do not touch the roll or paper at during the alignment process.
- When loading a roll, the roll cover must remain open until the front panel prompts you to close it.

If the paper has not been inserted straight, the printer attempts to straighten the roll.

If you would like to start the load process again, cancel the process on the front panel and rewind the roll from the end of the spindle until the edge is removed from the printer.



---

**NOTE:** If the roll has become loose around the core, the printer cannot load the paper.

---

## Unsuccessful sheet load

- Guide the sheet, especially thick papers, when the printer initially feeds the sheet.
- Ensure that the sheet is aligned with the reference line on the roll cover.
- Do not attempt to straighten the sheet during the loading process, unless instructed to by the front-panel display.
- Do not use hand-cut sheets, which may be of irregular shapes. Use only purchased sheets.
- Ensure the single sheet is not skewed.

In case of any problem, follow the instructions given on the front-panel display.

If you would like to start the load process again, cancel the process on the front panel; the printer ejects the sheet.



## Paper loading error messages

Here is a list of front-panel messages related to paper loading, with the suggested corrective action.

Front-panel message	Suggested action
Paper incorrectly loaded	The paper has not been loaded correctly. Remove the paper.
Paper loaded with too much skew	During the paper load process the printer detected that the paper had too much skew. Follow the instructions on the front-panel display.
Paper loose around core	The end of the roll has become loose around the core. Tighten the paper to the core or insert a new roll.
Paper not detected	During the paper load process the printer did not detect any paper. Ensure the paper is inserted fully and is not transparent.
Roll cover closed during paper load process	Do not close the roll cover until you are prompted to do so by the front panel.
Sheet too big	During the load process the printer has detected that the sheet of paper is either too wide or too long to be loaded correctly. Follow the instructions on the front-panel display.
Sheet too small	During the load process the printer detected that the sheet of paper is too narrow or too short to be loaded in the printer. Follow the instructions on the front-panel display.
Upper roll load and paper is inserted through the single sheet path	Avoid inserting roll paper into the cut sheet slot.

## Paper type is not in the driver

To work with a paper not in the driver, you can use your paper as one of the presets already in the driver, however, you must identify whether your paper is transparent or translucent, glossy or matte.



**NOTE:** For glossy paper, it is important to use a glossy paper type, as matte black ink does not print well on glossy paper.

### Glossy paper

If your paper is a photo paper, use the **Photo Paper** category.

### Matte paper

If your paper is a matte paper, use any of the papers in the **Bond and Coated Paper** category. If your paper is classified as photo matte, its category depends on whether it can hold matte black ink. In this case, try both with **Heavyweight Coated Paper** and with **Photo Semi Gloss/Satin Paper**, and choose the best result.

### General-purpose paper

- For natural tracing papers, select paper type **Natural Tracing Paper < 65 g/m<sup>2</sup>** or **Natural Tracing Paper > 65 g/m<sup>2</sup>**, depending on the weight of the paper.
- For thin papers (< 90 g/m<sup>2</sup>) uncoated papers (for example plain paper or bright white paper) select paper type **Bond and Coated Paper > Plain Paper**.
- For light coated papers (< 110 g/m<sup>2</sup>), select paper type **Bond and Coated Paper > HP Coated Paper**.

- For heavyweight coated papers (< 200 g/m<sup>2</sup>), select paper type **Bond and Coated Paper > Heavyweight Coated Paper**.
- For cockle-free very thick coated papers (> 200 g/m<sup>2</sup>), select paper type **Bond and Coated Paper > Super Heavyweight Coated Paper**.

## Black ink is easily removed when touched

This happens when your paper is incompatible with matte black ink. To use non-matte black ink, select any of the papers in the **Photo Paper** category.

## After printing, the paper has wrinkles or there is too much ink

This happens when too much ink is used. To use less ink, select a thinner category. Matte paper categories from thinnest to thickest are:

- Plain Paper
- Coated Paper
- Heavyweight Coated Paper
- Super Heavyweight Coated Paper

For other image quality problems, see [Troubleshooting print-quality issues on page 156](#).

## Printer printed on the wrong paper type

If the printer prints your job before you were able to load your desired paper, you may have **Use Printer Settings** selected for the Paper Type in the printer driver. When either of these is selected, the printer will print immediately on whichever paper is loaded. Load your desired paper, see [Paper handling on page 31](#), and select your paper type specifically in the driver.

- **In the Windows driver dialog:** select the **Paper/Quality** or **Paper** tab (depending on the driver version), then select your paper type from the Paper Type list.



---

**NOTE:** **Use Printer Settings** (Windows) is the driver default.

---

## Automatic cut not available

Some paper types cannot be cut by the automatic cutter. When such a paper type is loaded and active, the printer cannot switch automatically to the other roll: the active roll must first be unloaded manually.

## On hold for paper

Based on a set of conditions that you can set when sending a job (see [Solve paper mismatch on page 82](#)), the printer will decide which of the loaded rolls of paper is more suitable to print the job. If there is no roll of paper available that meets all the conditions, the printer will put the job on hold for paper. You can manually resume the job, forcing it to print on a paper other than the one originally specified, otherwise it will stay on hold.



---

**NOTE:** When an uncuttable roll is active, every job sent to any other paper source is put on hold until you manually unload the uncuttable roll.

---

## Which criteria are used to decide on which roll a job will be printed?

When a user sends a job, the desired paper type can be set in the driver. The printer will print the job on a roll of paper of the chosen paper type that is large enough to print the drawing without clipping. If there is more than one roll on which the job could be printed meeting all the criteria, the roll will be chosen according to your preferences. These can be set from the front panel: see [Roll policies on page 81](#).

## When is a job put on hold for paper?

If the paper mismatch action is set to **Pause and ask** (see [Solve paper mismatch on page 82](#)), a job is put on hold for paper in the following cases:

- The paper type that has been selected by the user is not currently loaded on the specified roll—or on either of the rolls, if no roll has been specified.
- The paper type that has been selected by the user is loaded on the specified roll, but the drawing is too large to fit on the roll—or on either of the rolls, if no roll has been specified.

## If I load a new roll of paper, will jobs that were on hold for paper be automatically printed?

Yes. Every time a new roll of paper is loaded, the printer will check if there are any jobs on hold for paper that could be printed on the loaded roll.

## I don't like jobs being put on hold for paper. Can I prevent it?

Yes, this can be done from the front panel: see [Solve paper mismatch on page 82](#).

## My job is exactly as wide as the roll of paper that is loaded on the printer, but is put on hold for paper

Margins are managed in different ways depending on the file type:

- For HP-GL/2 and HP RTL files, by default, margins are included inside the drawing, so a 914 mm (36 in) HP-GL/2 and HP RTL file can be printed on a 914 mm (36 in) roll of paper and will not be put on hold for paper.
- For other file formats, such as PostScript, PDF, TIFF, or JPEG, the printer assumes that margins need to be added outside the drawing (as, in many cases, these formats are used for photographs and other images that do not include margins). This means that, to print a 914 mm (36 in) TIFF, the printer needs to add margins, and the drawing needs 925 mm (36.4 in) of paper to be printed; this would cause the job to be put on hold if the paper that is loaded on the printer is only 914 mm (36 in) wide.

If you wish to print these file formats without adding extra margins outside of the drawing, the **Clip contents by margins** option can be used. This option will force the margins to be set inside of the drawing, so a 914 mm (36 in) TIFF can be printed on a 914 mm (36 in) roll of paper without being put on hold. However, if there is no white space already included in the drawing's borders, some contents could be clipped because of the margins.

## The paper has jammed in the print platen

When a paper jam occurs, you normally see the **Possible paper jam** message in the front-panel display. The front panel starts the paper jam wizard which displays where the jam has occurred and how to fix it. Clear the paper jam as instructed on each wizard screen.

1. Lift the window.

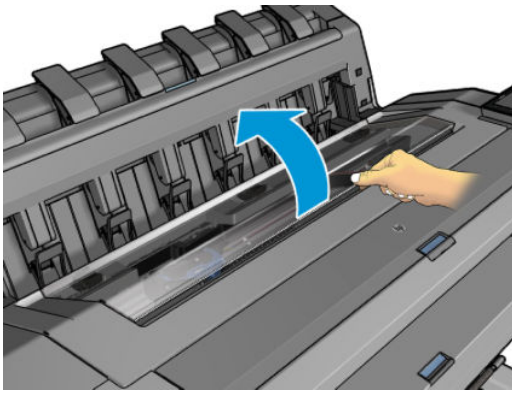

2. Move the carriage manually to the left side of the printer, if feasible.

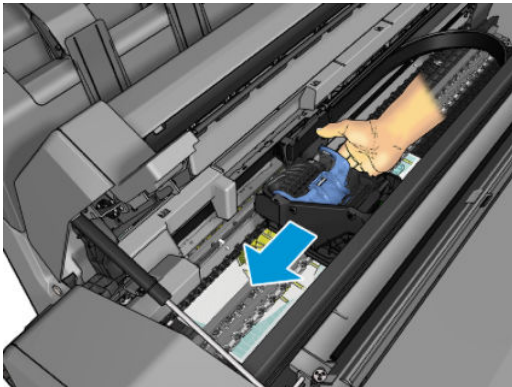

3. Go to the paper path.

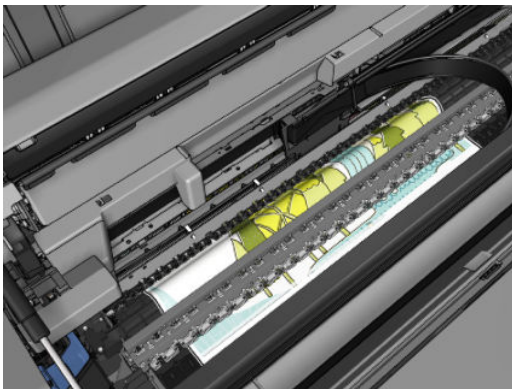

4. Cut the paper with a pair of scissors.

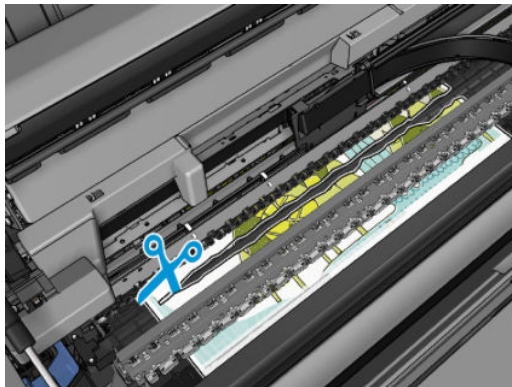
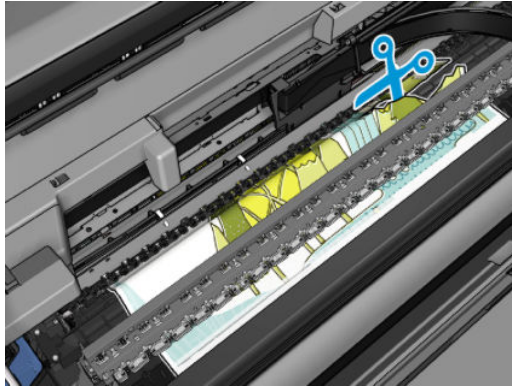

5. Open the roll cover.

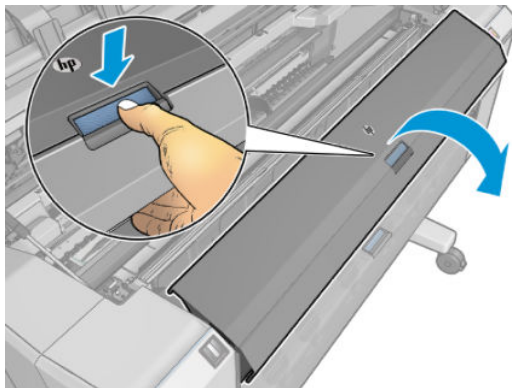

6. Manually rewind paper onto the roll.

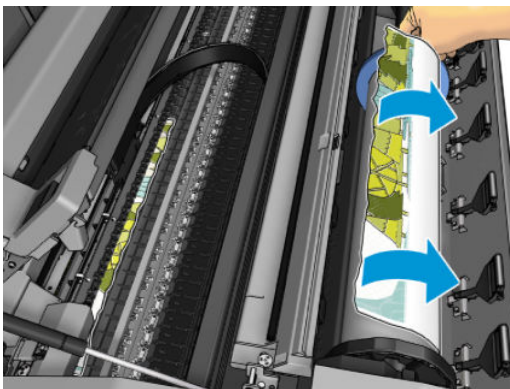
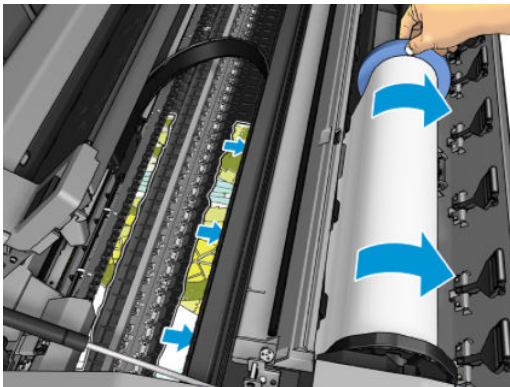
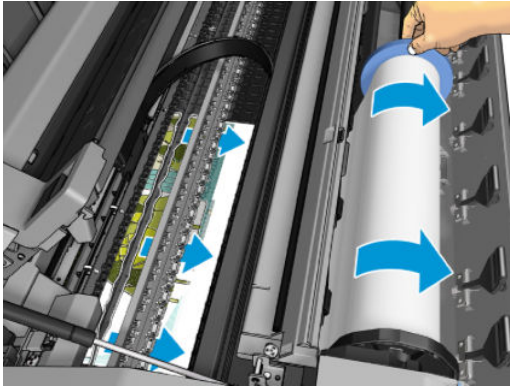

7. If the leading edge of the paper is ragged, trim it carefully with scissors.

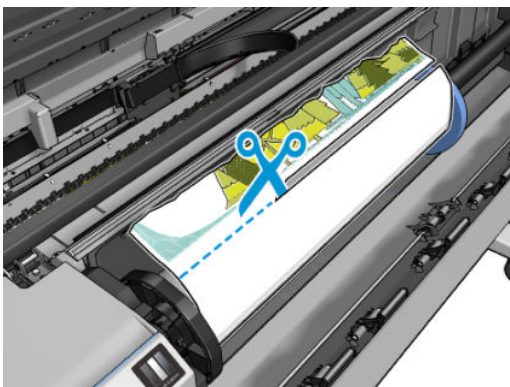

8. Remove the paper left in the printer.

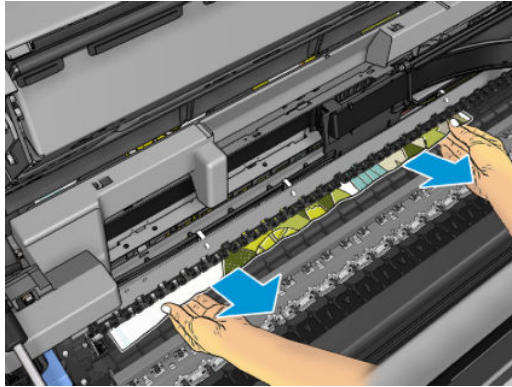

9. Make sure you have removed every fragment of paper.

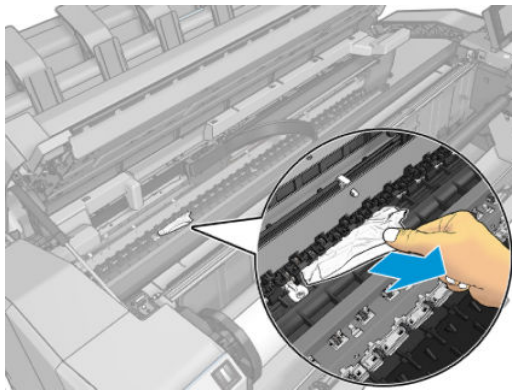

10. Lower the window and close the roll cover.

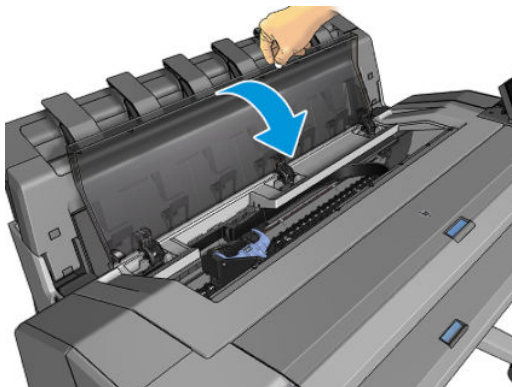

11. Restart the printer by holding down the power button for a few seconds, or by turning the power switch at the rear off and then on.
12. Reload the roll, or load a new sheet see [Paper handling on page 31](#).

---

 **NOTE:** If you find that there is still some paper causing an obstruction within the printer, restart the procedure and carefully remove all pieces of paper.

---

## The paper has jammed in the stacker

When a paper jam is detected in the stacker, printing is paused, and the front panel asks you to open the stacker cover and clear the jam by pulling out the paper.

When the stacker cover is closed and the printer detects no jammed paper, the front panel requests confirmation to continue printing.

## The printer reports unexpectedly that the stacker is full

The printer may report that the stacker is full in the following circumstances:

- When there is a paper jam in the stacker
- When you are using very thin or very stiff paper, such as heavyweight coated paper
- When you are sending small paper sizes to the stacker, such as A3 portrait or A2 landscape



## A strip stays on the output tray and generates jams

If a small piece of paper (200 mm or smaller) has been cut, such as before (if new roll) and after a full-bleed print or after the front-panel option **Move and cut** has been used, the cut strip remains in the output tray. Only when the printer is not printing, reach into the tray and remove the strip.

## Printer displays out of paper when paper is available

If the roll has become loose from its core, it will not feed correctly and the printer will not load the paper. If possible, tighten the paper to its core or load a new roll.

## Prints do not fall neatly into the basket

- Ensure that the basket is correctly installed.
- Ensure that the basket is open.
- Ensure that the basket is not full.
- Paper often tends to curl near the end of a roll, which can cause output problems. Load a new roll, or remove prints manually as they are completed.

## Sheet stays in the printer when the print has been completed

The printer holds the paper to allow the print to dry after printing, see [Change the drying time on page 46](#). If the paper is only partially ejected after the drying time, gently pull the sheet out of the printer. If the automatic cutter is disabled, use the **Move and cut** option in the front panel, see [Clean cut on page 47](#).

## Paper is cut when the print has been completed

By default the printer cuts the paper after the drying time has been completed, see [Change the drying time on page 46](#). You can disable the cutter, see [Turn the automatic cutter on and off on page 47](#).

## Cutter does not cut well

By default, the printer is set to cut the paper automatically after the drying time has been completed. If the cutter is turned on but not cutting correctly, check that the cutter rail is clean and clear of any obstacles.

If the cutter is turned off, **Move and cut** only advances the paper. Use it to move the print far enough out of the front of the printer, until it is convenient to cut manually with a straight edge or scissors.

## Roll is loose on the spindle



The roll may need to be replaced or reloaded.

Ensure that you are using the right core, and use the HP DesignJet 3-in Core Adapter when needed.

## Recalibrate the paper advance

Accurate paper advance is important to print quality because it is part of controlling the proper placement of dots on the paper. If the paper is not advanced the proper distance between printhead passes, light or dark bands appear in the print and image grain may increase.

The printer is calibrated to advance correctly with all the papers appearing in the front panel. When you select the type of loaded paper, the printer adjusts the rate at which to advance the paper while printing. However, if you are not satisfied with the default calibration of your paper, you may need to recalibrate the rate at which the paper advances. See [Troubleshooting print-quality issues on page 156](#) for steps to determine if paper advance calibration will solve your issue.

You can check the paper advance calibration status of the currently loaded paper from the front panel at any time by tapping , then , then , then **Calibration status**. The status may be one of the following:

- **DEFAULT:** This status appears when loading any paper that has not been calibrated. HP papers in the Front Panel have been optimized by default and unless you experience image quality problems in your printed image such as banding or graininess it is not recommended to recalibrate the paper advance.
- **OK:** This status indicates that the loaded paper has been calibrated before. However you may need to repeat the calibration if you experience print-quality problems such as banding or graininess in your printed image.

---

 **NOTE:** Whenever you update the printer's firmware, the paper advance calibration values are reset to factory default, see [Update the firmware on page 134](#).

---

## Recalibrating the paper advance procedure

---

 **CAUTION:** If you are using a transparent paper or film, go directly to step 3 of this procedure.

---

1. From the front panel, tap , then **Paper advance calibration > Continue**. The printer automatically recalibrates the paper advance and prints a paper advance calibration image.
2. Wait until the front panel displays the status page, and reprint your print.

---

 **NOTE:** The recalibration procedure takes approximately three minutes. Do not worry about the paper advance calibration image. The front-panel display shows any errors in the process.

---

If you are satisfied with your print continue using this calibration for your paper type. If you see improvement in your print, continue with step three. If you are dissatisfied with the recalibration, return to the default calibration, see [Return to default calibration on page 155](#).

3. If you would like to fine-tune the calibration or are using a transparent paper, tap , then **Paper advance calibration > Adjust paper advance**.

4. Select the percentage of change from -100% to +100%. To correct light banding, decrease the percentage.

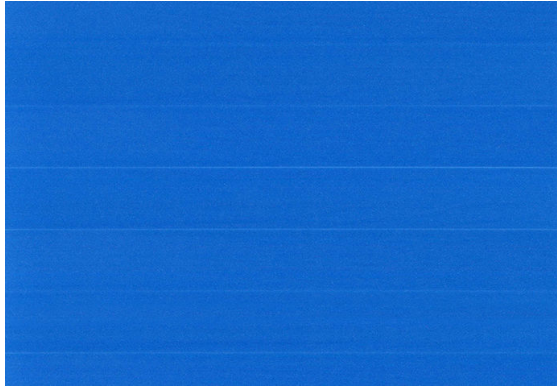

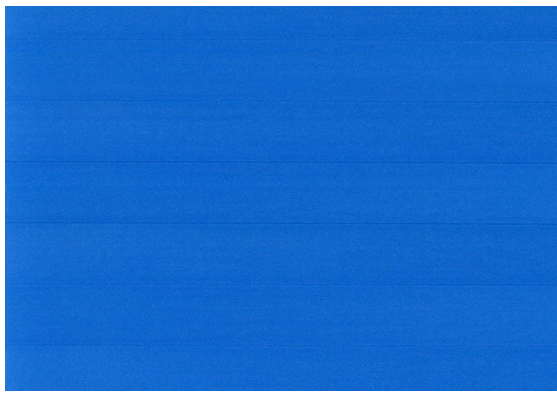

To correct dark banding, increase the percentage.



5. Tap  on the front panel to return to the all-apps page.

## Return to default calibration

Returning to the default calibration sets all the corrections made by the paper advance calibration to zero. To return to the default paper advance calibration value, you must reset the calibration.

1. From the front panel, tap , then , then , then **Reset calibration**.
2. Wait until the front panel displays the operation has completed successfully.

---

# 15 Troubleshooting print-quality issues

- [General advice](#)
- [Horizontal lines across the image \(banding\)](#)
- [Whole image is blurry or grainy](#)
- [Paper is not flat](#)
- [Print is scuffed or scratched](#)
- [Ink marks on the paper](#)
- [Black horizontal lines on yellow background](#)
- [Black ink comes off when you touch the print](#)
- [Edges of objects are stepped or not sharp](#)
- [Edges of objects are darker than expected](#)
- [Horizontal lines at the end of a cut sheet print](#)
- [Vertical lines of different colors](#)
- [White spots on the print](#)
- [Colors are inaccurate](#)
- [Colors are fading](#)
- [Image is incomplete \(clipped at the bottom\)](#)
- [Image is clipped](#)
- [Some objects are missing from the printed image](#)
- [Lines are too thick, too thin or missing](#)
- [Lines appear stepped or jagged](#)
- [Lines print double or in the wrong colors](#)
- [Lines are discontinuous](#)
- [Lines are blurred](#)
- [Line lengths are inaccurate](#)

- [Image Diagnostics Print](#)
- [If you still have a problem](#)

## General advice

When you have any print-quality problem:

- To achieve the best performance from your printer, use only genuine manufacturer's supplies and accessories, whose reliability and performance have been thoroughly tested to give trouble-free performance and best-quality prints. For details of recommended papers, see [Order paper on page 138](#).
- Make sure that the paper type selected in the front panel is the same as the paper type loaded into the printer (see [View information about the paper on page 44](#)). At the same time, check that the paper type has been calibrated. Also make sure that the paper type selected in your software is the same as the paper type loaded into the printer.

---

**⚠ CAUTION:** If you have the wrong paper type selected, you could experience poor print quality and incorrect colors, and perhaps even damage to the printheads.

---

- Check that you are using the most appropriate print-quality settings for your purposes (see [Printing on page 60](#)). You are likely to see lower print quality if you have moved the print-quality slider to the 'Speed' end of the scale, or set the custom quality level to **Fast**.
- Check that your environmental conditions (temperature, humidity) are in the recommended range. See [Environmental specifications on page 191](#).
- Check that your ink cartridges and printheads have not passed their expiration dates: see [Maintain the ink cartridges on page 133](#).

## Horizontal lines across the image (banding)

If your printed image suffers from added horizontal lines as shown (the color may vary):



1. Check that the paper type you have loaded corresponds to the paper type selected in the front panel and in your software. See [View information about the paper on page 44](#).
2. Check that you are using appropriate print-quality settings for your purposes (see [Printing on page 60](#)). In some cases, you can overcome a print-quality problem merely by selecting a higher print-quality level. For instance, if you have set the Print Quality slider to **Speed**, try setting it to **Quality**. If you change the print-quality settings, you may wish to reprint your job at this point in case the problem has been solved.

3. Print the Image Diagnostics Print and follow the instructions in [Image Diagnostics Print on page 169](#), including printhead cleaning if recommended.
4. If the printheads are working correctly, go to the front panel and tap , then **Paper advance calibration**. Choose the paper source and then **Paper advance calibration**. See [Recalibrate the paper advance on page 154](#).

If the problem persists despite all the above actions, contact your customer service representative for further support.

## Whole image is blurry or grainy



1. Check that the paper type you have loaded corresponds to the paper type selected in the front panel and in your software. See [View information about the paper on page 44](#).
2. Check that you are printing on the correct side of the paper.
3. Check that you are using appropriate print-quality settings (see [Printing on page 60](#)). In some cases, you can overcome a print-quality problem merely by selecting a higher print-quality level. For instance, if you have set the Print Quality slider to **Speed**, try setting it to **Quality**. If you change the print-quality settings, you may wish to reprint your job at this point in case the problem has been solved.
4. Realign the printheads. See [Align the printhead on page 175](#). After alignment, you may wish to reprint your job in case the problem has been solved.
5. Clean the printhead drop detector.
6. Go to the front panel and tap , then **Paper advance calibration**. Choose the paper source. See [Recalibrate the paper advance on page 154](#).

If the problem persists despite all the above actions, contact your customer service representative for further support.

## Paper is not flat

If the paper does not lie flat when it comes out of the printer, but has shallow waves in it, you are likely to see defects in the printed image, such as vertical stripes. This can happen when you use thin paper that becomes saturated with ink.



1. Check that the paper type you have loaded corresponds to the paper type selected in the front panel and in your software. See [View information about the paper on page 44](#).
2. Try changing to a thicker paper type, such as HP Heavyweight Coated Paper or HP Super Heavyweight Plus Matte Paper.
3. Select a paper type that is slightly thinner than the paper you have loaded; this will cause the printer to use less ink. Here are some example paper types in ascending order of thickness: Plain Paper, Coated Paper, Heavyweight Coated Paper, Super Heavyweight Plus Matte Paper.

## Print is scuffed or scratched

The black ink pigment can be scuffed or scratched when touched by a finger, a pen or some other object. This is particularly noticeable on coated paper.

Glossy paper may be extremely sensitive to the basket or to anything else that it contacts soon after printing, depending on the amount of ink used and the environmental conditions at the time of printing.

To reduce the risk of scuffs and scratches:

- Handle prints carefully.
- Avoid stacking prints on top of each other.
- Catch your prints as they are cut from the roll and do not let them fall into the basket. Alternatively, leave a sheet of paper in the basket so that freshly printed sheets do not make direct contact with the basket.
- Try loading the paper in sensitive-paper mode.





## Ink marks on the paper

This problem can occur for several different reasons.

### Horizontal smears on the front of coated paper

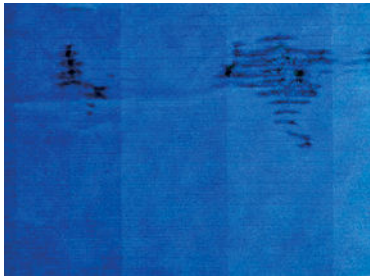
If a lot of ink is used on plain or coated paper, the paper absorbs the ink quickly and expands. As the printheads move over the paper, the printheads may come into contact with the paper and smear the printed image. This problem is normally seen only on cut sheets of paper (not on roll paper).



Whenever you notice this problem, cancel the printing job immediately. Tap  and also cancel the job from your computer application. Soaked paper can damage the printheads.

Try the following suggestions to avoid this problem:

1. Check that the paper type you have loaded corresponds to the paper type selected in the front panel and in your software. See [View information about the paper on page 44](#).
2. Use a recommended paper type (see [Order paper on page 138](#)) and the correct print settings.
3. If using sheet paper, try rotating the sheet 90 degrees. The orientation of the paper fibers may affect performance.
4. Try changing to a thicker paper type, such as HP Heavyweight Coated Paper and HP Super Heavyweight Plus Matte Paper.
5. Select a paper type that is slightly thinner than the paper you have loaded; this will cause the printer to use less ink. Here are some example paper types in ascending order of thickness: Plain Paper, Coated Paper, Heavyweight Coated Paper, Super Heavyweight Plus Matte Paper.
6. Try to increase the margins by relocating the image to the center of the page using your software application.

### Ink marks on the back of the paper

Clean the platen with a soft cloth. Clean each rib separately without touching the foam between the ribs.

## Black horizontal lines on yellow background

This problem may be caused by storing the printer in a cold environment.

Go to the front panel and tap , then **Clean printheads**.

## Black ink comes off when you touch the print

This problem may be caused by printing with matte black ink on glossy paper. The printer will not use matte black ink if it knows that the paper will not retain it. To be sure of avoiding matte black ink, you can select any paper type from the Photo Paper category.

## Edges of objects are stepped or not sharp

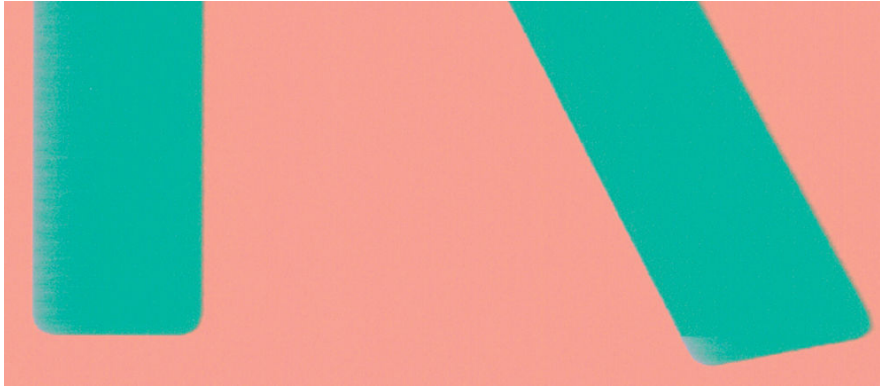

1. If edges of objects or lines appear to be poorly defined or lighter in density, and you have already set the print-quality slider to **Quality** in the print dialog box, select the custom print-quality options, and try setting the quality level to **Normal**. See [Printing on page 60](#).
2. The issue may be related to orientation. Try rotating the image: you may find that the result looks better.

## Edges of objects are darker than expected



1. If edges of objects seem darker than expected, and you have already set the print-quality slider to **Quality** in the driver dialog, select the custom print-quality options, and try setting the quality level to **Normal**. See [Printing on page 60](#).
2. The issue may be related to orientation. Try rotating the image: you may find that the result looks better.

## Horizontal lines at the end of a cut sheet print

This type of defect affects only the end of a print, within approximately 30 mm of the trailing edge of the paper. You may see some very thin horizontal lines across the print.

To avoid this problem:

1. Consider using larger margins around your image.
2. Print the Image Diagnostics Print. See [Image Diagnostics Print on page 169](#).
3. Consider printing with roll paper.

## Vertical lines of different colors

If your print has vertical bands of different colors along it:

1. Try using thicker paper, choosing from the recommended paper types such as HP Heavyweight Coated Paper and HP Super Heavyweight Paper. See [Order paper on page 138](#).
2. Try using higher print-quality settings (see [Printing on page 60](#)). For instance, if you have set the Print Quality slider to **Speed**, try setting it to **Quality**.

## White spots on the print



You may notice white spots on the print. This is probably due to paper fibers, dust, or loose coating material. To avoid this problem:

1. Try cleaning the paper manually with a brush before printing, to remove any loose fibers or particles.
2. Always keep the cover of your printer closed, and avoid actions that may introduce dust into the printer, such as handling or cutting paper on the printer cover.
3. Protect your paper rolls and sheets by storing them in bags or boxes.

## Colors are inaccurate



If the colors of your print do not match your expectations, try the following:

1. Check that the paper type you have loaded corresponds to the paper type selected in the front panel and in your software. See [View information about the paper on page 44](#).
2. Tap , then , then **Calibration Status** to check the color calibration status. If the status is PENDING or OBSOLETE, you should perform color calibration: see [Color calibration on page 88](#). If you have made any changes, you may wish to reprint your job in case the problem has been solved.
3. Check that you are printing on the correct side of the paper.

4. Check that you are using appropriate print-quality settings (see [Printing on page 60](#)). If you have selected the **Speed** or **Fast** options, you may not get the most accurate colors. If you change the print-quality settings, you may wish to reprint your job at this point in case the problem has been solved.
5. If you are using Application Color Management, check that the color profile you are using corresponds to the selected paper type and print-quality settings. If you have doubts about which color settings to use, see [Color management on page 87](#).
6. If a grayscale image shows a color cast in some of the gray shadows, click **Color > Grayscale** in the driver.
7. If the problem consists of color differences between your print and your monitor, try calibrating your monitor. At this point, you may wish to reprint your job in case the problem has been solved.
8. Print the Image Diagnostics Print. See [Image Diagnostics Print on page 169](#).

If the problem persists despite all the above actions, contact your customer service representative for further support.



## Colors are fading

If you print on instant-dry photo paper, your prints will fade rapidly. If you plan to display the prints for more than two weeks, you should laminate them to achieve longer life.

Alternatively, prints on swellable coated papers such as HP Universal Gloss Photo Paper or HP Universal Satin Photo Paper will fade much less rapidly.

Lamination can increase the life of prints on all paper types, depending on the type of lamination. For more information, consult your laminate provider.

## Image is incomplete (clipped at the bottom)

- Did you tap  before all the data were received by the printer? If so, you have ended the data transmission and will have to print the page again.
- The **I/O timeout** setting may be too short. This setting determines how long the printer waits for the computer to send more data, before deciding that the job is finished. From the front panel, increase the **I/O timeout** setting to a longer period and then send the print again. Tap , then **Connectivity > Network > I/O timeout**.
- There may be a communications problem between your computer and the printer. Check your USB or network cable.
- Check to make sure that your software settings are correct for your current page size (for example, long-axis prints).
- If you are using network software, make sure it has not timed out.

## Image is clipped

Clipping normally indicates a discrepancy between the actual printable area on the loaded paper and the printable area as understood by your software. You can often identify this kind of problem before printing by previewing your print (see [Preview a print on page 69](#)).

- Check the actual printable area for the paper size you have loaded.

printable area = paper size – margins

- Check what your software understands to be the printable area (which it may call "printing area" or "imageable area"). For example, some software applications assume standard printable areas that are larger than those used in this printer.
- If you have defined a custom page size with very narrow margins, the printer may impose its own minimal margins, clipping your image slightly. You may want to consider using a larger paper size.
- If your image contains its own margins, you may be able to print it successfully by using the **Clip Contents by Margins** option (see [Select margin options on page 67](#)).
- If you are trying to print a very long image on a roll, check that your software is capable of printing an image of that size.
- If you try to print an image larger than your software can handle, the bottom of the image may be clipped. To print the whole image, try these suggestions:
  - Save the file in another format, such as TIFF or EPS, and open it with another application.
  - Use a RIP to print the file.
- You may have asked to rotate the page from portrait to landscape on a paper size that is not wide enough.
- If necessary, reduce the size of the image or document in your software application, so it fits between the margins.

## Some objects are missing from the printed image

Large quantities of data may be necessary to print a high-quality large-format print job, and in some specific workflows there may be issues that can lead to some objects missing from the output. Here are some suggestions to help you to avoid this problem:

- Select a smaller page size and scale to the desired final page size in the driver or in the front panel.
- Save the file in another format, such as TIFF or EPS, and open it with another application.
- Use HP Click software to print the file.
- Use a RIP to print the file.
- Try printing from a USB flash drive.
- Reduce the resolution of bitmap images in your application software.
- Select a lower print quality in order to reduce the resolution of the printed image.





---

**NOTE:** If you are working under Mac OS X, not all of these options are available.

These options are suggested for troubleshooting purposes and may adversely affect the final output quality or the time necessary to generate the print job. Therefore, they should be canceled if they do not help to solve the problem.

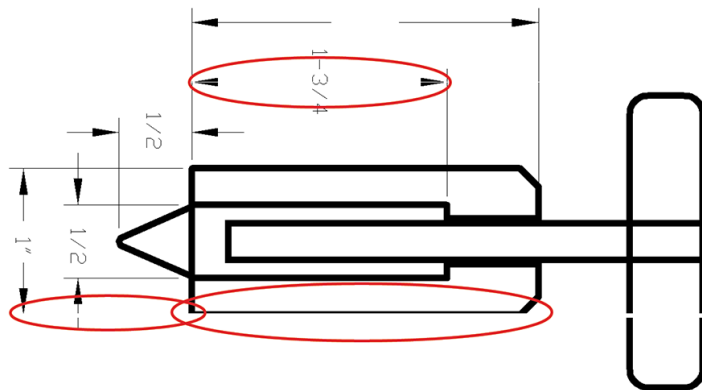
## Lines are too thick, too thin or missing



1. Check that the paper type you have loaded corresponds to the paper type selected in the front panel and in your software. See [View information about the paper on page 44](#).
2. Check that you are using appropriate print-quality settings for your purposes (see [Printing on page 60](#)). Select the custom print-quality options in the driver dialog, and try turning on the **Maximum detail** option (if available). You may wish to reprint your job at this point in case the problem has been solved.
3. If the resolution of your image is greater than the printing resolution, you may notice a loss of line quality.
4. If lines are too thin or missing, print the Image Diagnostics Print. See [Image Diagnostics Print on page 169](#).
5. If the problem remains, go to the front panel and tap , then **Printhead alignment** to align the printheads. See [Align the printhead on page 175](#). After alignment, you may wish to reprint your job in case the problem has been solved.
6. Go to the front panel and tap , then perform paper advance calibration: see [Recalibrate the paper advance on page 154](#).

If the problem persists despite all the above actions, contact your customer service representative for further support.

## Lines appear stepped or jagged

If lines in your image appear stepped or jagged when printed:



1. The problem may be inherent in the image. Try to improve the image with the application you are using to edit it.
2. Check that you are using appropriate print-quality settings. See [Printing on page 60](#).
3. Select the custom print-quality options in the driver dialog, and turn on the **Maximum detail** option (if available).

## Lines print double or in the wrong colors

This problem can have various visible symptoms:

- Colored lines are printed double, in different colors.

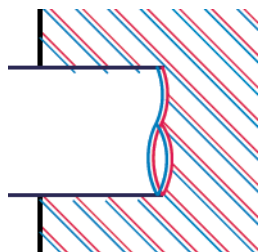

- The borders of colored blocks are wrongly colored.



To correct this kind of problem:

1. Reseat the printheads by removing them and then reinserting them. See [Remove the printhead on page 125](#) and [Insert the printhead on page 128](#).
2. Align the printheads. See [Align the printhead on page 175](#).

## Lines are discontinuous

If your lines are broken in the following way:



1. Check that you are using appropriate print-quality settings. See [Printing on page 60](#).
2. Reseat the printheads by removing them and then reinserting them. See [Remove the printhead on page 125](#) and [Insert the printhead on page 128](#).
3. Align the printheads on the paper that you have the issue with. See [Align the printhead on page 175](#).

## Lines are blurred



Humidity can cause ink to soak into the paper, making the lines blurred and fuzzy. Try the following:

1. Check that your environmental conditions (temperature, humidity) are suitable for high-quality printing. See [Environmental specifications on page 191](#).
2. Check that the paper type selected in the front panel is the same as the paper type you are using. See [View information about the paper on page 44](#).
3. Select the custom print-quality options, then select **Best** and **Maximum detail** (if available). See [High-quality printing on page 70](#).
4. Try changing to a heavier paper type, such as HP Heavyweight Coated Paper or HP Super Heavyweight Plus Matte Paper.
5. Select a paper type that is slightly thinner than the paper you have loaded; this will cause the printer to use less ink. Here are some example paper types in ascending order of thickness: Plain Paper, Coated Paper, Heavyweight Coated Paper, Super Heavyweight Plus Matte Paper.
6. If you are using glossy paper, try changing to a different type of glossy paper.
7. Align the printheads. See [Align the printhead on page 175](#).

## Line lengths are inaccurate

If you have measured your printed lines and find that the lengths are not sufficiently accurate for your purposes, you can try to improve line length accuracy in the following ways:



1. Print on HP Matte Film, for which your printer's line length accuracy is specified. See [Functional specifications on page 188](#).  
  
Polyester film is about ten times more dimensionally stable than paper. However, using film that is thinner or thicker than HP Matte Film will reduce line length accuracy.
2. Set the Print Quality slider to **Quality**.
3. Maintain the room at a steady temperature between 10 and 30°C (50 and 86°F).
4. Load the roll of film and let it rest for five minutes before printing.
5. If you are still not satisfied, try recalibrating the paper advance. See [Recalibrate the paper advance on page 154](#).



# Image Diagnostics Print

The Image Diagnostics Print consists of patterns designed to highlight printhead reliability problems. It helps you to check the performance of the printheads that are currently installed in your printer, and whether any printhead suffers from clogging or other problems.

To print the Image Diagnostics Print:

1. Use the same paper type that you were using when you detected a problem.
2. Check that the selected paper type is the same as the paper type loaded into the printer. See [View information about the paper on page 44](#).
3. At the printer's front panel, tap , then , then , then **Print diagnostic image**.

It takes about two minutes to print the Image Diagnostics Print.

The print is divided into two parts, both of which test printhead performance:

- Part 1 (top) consists of rectangles of pure colors, one for each printhead. This part represents the print quality that you will get from each color.
- Part 2 (bottom) consists of small dashes, one for each nozzle on each printhead. This part complements the first, and aims more specifically to detect how many faulty nozzles each printhead has.

Look carefully at the print. The names of the colors are shown above the rectangles and in the center of the patterns of dashes.

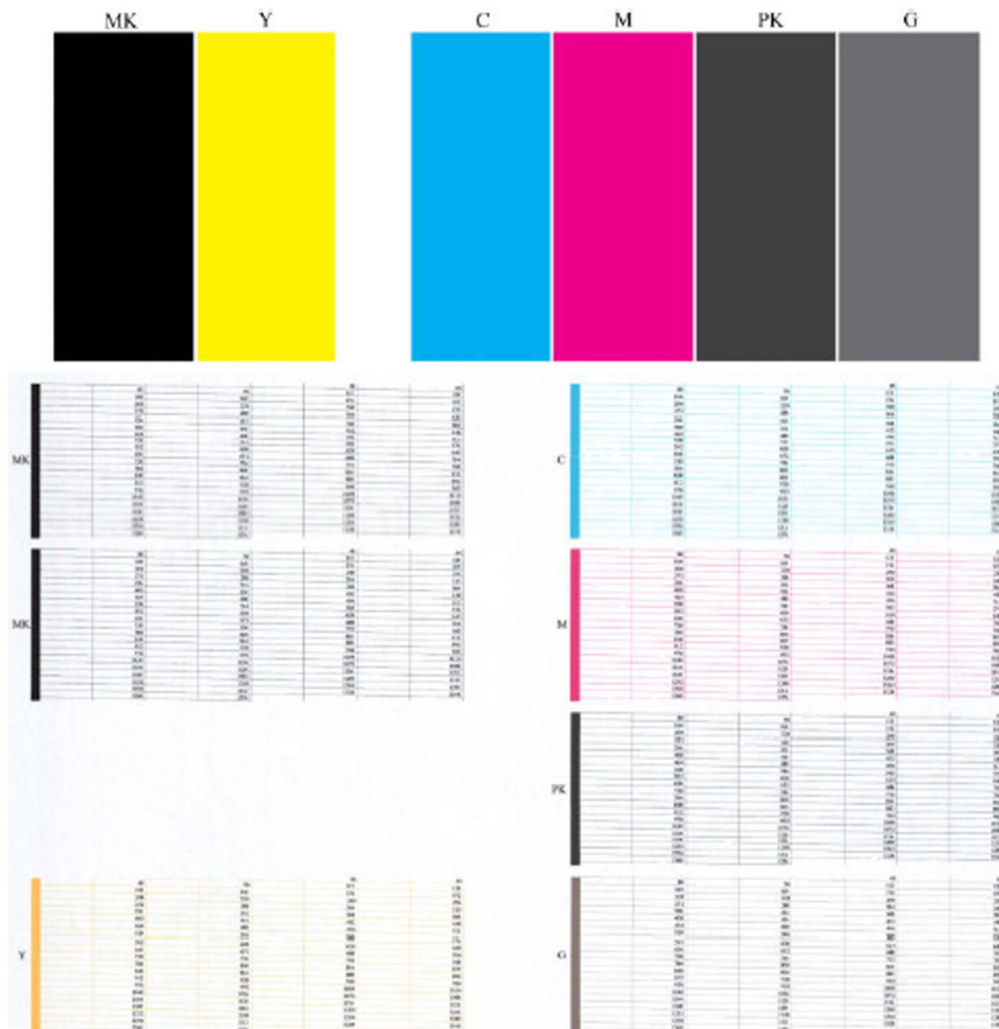

First look at the upper part of the print (part 1). Each colored rectangle should be a uniform color without any horizontal lines across it.

Then look at the bottom part of the print (part 2). For each individual colored pattern, check that most of the dashes are present.

If you see horizontal lines in part 1 and also missing dashes in part 2 for the same color, the printhead responsible needs cleaning. However, if the rectangles look solid, do not worry about just a few missing dashes in part 2; these are acceptable because the printer can compensate for a few clogged nozzles.

Here is an example of a gray printhead in a good state:

G

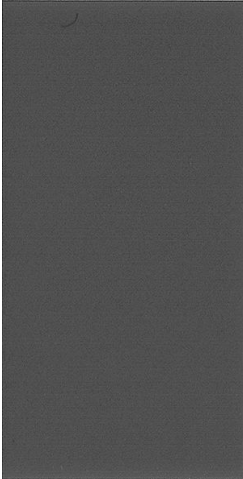

And here is an example of the same printhead in a bad state:

G

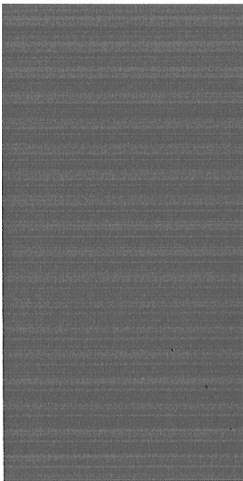

## Corrective action

1. Clean any faulty printheads (see [Clean the printhead on page 175](#)). Then reprint the Image Diagnostics Print to see whether the problem has been solved.
2. If the problem remains, clean the printheads again, and reprint the Image Diagnostics Print to see whether the problem has been solved.
3. If the problem remains, consider cleaning your printheads manually (see [Clean the printhead on page 175](#)). You could also try reprinting your current print job, in case it now prints satisfactorily.
4. If the problem remains, try cleaning the printhead drop detector. The printer normally notifies you when this is necessary, but it may be worth trying even if the printer has not suggested it.
5. If the problem still remains, replace any persistently faulty printheads (see [Handling ink cartridges and printhead on page 120](#)), or contact HP Support (see [Contact HP Support on page 185](#)).

## If you still have a problem

If you still experience print-quality problems after applying the advice in this chapter, here are some further things that you can do:

- Try using a higher print-quality option. See [Printing on page 60](#).
- Check the driver you are using to print with. If it is a non-HP driver, consult the driver vendor about the problem. You could also try using the correct HP driver, if feasible. The latest HP drivers can be downloaded from <http://www.hp.com/go/DesignJetT1600/drivers>.
- If you are using a non-HP RIP, its settings may be incorrect. See the documentation that came with the RIP.
- Check that your printer's firmware is up to date. See [Update the firmware on page 134](#).
- Check that you have the right settings in your software application.

---

# 16 Troubleshooting ink cartridge and printhead issues

- [Cannot insert an ink cartridge](#)
- [Ink cartridge status messages](#)
- [Cannot insert the printhead](#)
- [The front-panel display recommends reseating or replacing the printhead](#)
- [Clean the printhead](#)
- [Align the printhead](#)
- [Printhead status messages](#)

## Cannot insert an ink cartridge

1. Check that you have the correct type of cartridge (model number).
2. Check that the colored label on the cartridge is the same color as the label on the slot.
3. Check that the cartridge is correctly oriented, with the letter or letters marking the cartridge label right-side up and readable.

---

 **CAUTION:** Never clean inside the ink cartridge slots.

---

## Ink cartridge status messages

These are the possible ink cartridge status messages:

- **OK:** The cartridge is working normally, with no known problems.
- **Missing:** There is no cartridge present, or it is not correctly connected to the printer.
- **Low:** The ink level is low.
- **Very low:** The ink level is very low.
- **Empty:** The cartridge is empty.
- **Reseat:** You are recommended to remove the cartridge and then reinsert it.
- **Replace:** You are recommended to replace the cartridge with a new cartridge.
- **Expired:** It is past the cartridge's expiration date.
- **Incorrect:** The cartridge is not compatible with this printer. The message includes a list of compatible cartridges.
- **Non-HP:** The cartridge is used, refilled, or counterfeit.

## Cannot insert the printhead

1. Check that you have the correct type of printhead (model number).
2. Check that you have removed the seven orange protective caps from the printhead.
3. Check that the printhead is correctly oriented.
4. Check that you have correctly closed and latched the printhead cover, see [Insert the printhead on page 128](#).

## The front-panel display recommends reseating or replacing the printhead

1. Remove the printhead, see [Remove the printhead on page 125](#).

2. Clean the electrical connections on the backside of the printhead with a lint-free cloth. You can carefully use a mild rubbing alcohol if moisture is needed to remove residue. Do not use water.

---

**⚠ CAUTION:** This is a delicate process and may damage the printhead. Do not touch the nozzles on the bottom side of the printhead, especially not with any alcohol.

---



3. Reinsert the printhead, see [Insert the printhead on page 128](#).
4. Check the front-panel display message. If the problem remains, try a new printhead.

## Clean the printhead

As long as the printer is kept turned on, automatic cleaning is performed periodically. This ensures there is fresh ink in the nozzles and prevents nozzle clogs, thus preserving print quality. If you have print quality problems, please see [Image Diagnostics Print on page 169](#) before proceeding.

To clean the printhead, go to the front panel and tap , then **Printheads**, and select the color group including the color that needs cleaning (**Clean all**, **Clean MK-Y**, **Clean C-M-PK-G**).

## Align the printhead

Precise printhead alignment is essential for accurate colors, smooth color transitions, and sharp edges in graphical elements. Your printer has an automatic printhead alignment process which runs whenever the printhead has been accessed or replaced.

You may need to align the printhead after a paper jam or if you are experiencing print-quality problems.

1. Load the paper you wish to use, see [Paper handling on page 31](#). You can use a roll or a cut sheet.

---

**⚠ CAUTION:** Do not use transparent or semi-transparent paper to align the printhead. HP recommends plain or bond paper.

---

2. Ensure that the window is closed, as a strong light source near the printer during printhead realignment can affect alignment.
3. From the front panel, tap , then **Align printheads**.

---

**📝 NOTE:** Printhead alignment can also be started from the Embedded Web Server (**Support > Print Quality Troubleshooting**), or from the HP Utility (Windows: **Support > Print Quality Troubleshooting**; Mac OS X: **Information and Print Quality > Align**).

---

4. If the loaded paper is satisfactory, the printer runs the realignment and prints a realignment pattern.
5. The process takes about five minutes. Wait until the front-panel display shows the process complete before using the printer.

If the printer cannot complete the printhead alignment successfully, you may be asked to clean the printhead and try again.

## Printhead status messages

These are the possible printhead status messages:

- **OK:** The printhead is working normally, with no known problems
- **Missing:** There is no printhead present, or it is not correctly installed in the printer.
- **Reseat:** You are recommended to remove the printhead and then reinsert it. If that fails, clean the electrical connections, see [The front-panel display recommends reseating or replacing the printhead on page 174](#). If that fails, replace the printhead with a new printhead, see [Remove the printhead on page 125](#) and [Insert the printhead on page 128](#).
- **Replace:** The printhead is failing. Replace the printhead with a working printhead, see [Remove the printhead on page 125](#) and [Insert the printhead on page 128](#).
- **Replacement incomplete:** The printhead replacement process has not completed successfully; re-launch the replacement process and let it finish completely.
- **Remove:** The printhead is not a suitable type for use in printing.
- **Non-HP ink:** Ink from a used, refilled, or counterfeit ink cartridge has passed through the printhead. See the limited warranty document provided with your printer for details of the warranty implications.



---

# 17 Troubleshooting general printer issues

- [Printer does not print](#)
- [Front panel fails to initialize](#)
- [Printer seems slow](#)
- [Communication failures between computer and printer](#)
- [Cannot access the Embedded Web Server](#)
- [Cannot access the network folder](#)
- [Cannot connect to the Internet](#)
- [Web Services issues](#)
- [Automatic file system check](#)
- [Alerts](#)

## Printer does not print

If all is in order (paper loaded, all ink components installed and no file errors), there are still reasons why a file you have sent from your computer may not start printing when expected:

- You may have an electrical power problem. If there is no activity at all from the printer, and the front panel does not respond, check that the power cable is connected correctly and that there is power available at the socket. Press the power key for 5 seconds to reset the printer.
- You may be experiencing unusual electromagnetic phenomena, such as strong electromagnetic fields or severe electrical disturbances, which can cause the printer to behave strangely or even stop working. In this case, turn off the printer using the power key on the front panel and unplug the power cord, wait until the electromagnetic environment has returned to normal, then turn it on again. If you still experience problems, contact your support representative.
- Nesting may be on, and the printer is waiting for the specified nest wait time before calculating the appropriate nests. In this case, the front panel shows the remaining time needed for nesting.
- You may have the wrong graphic language setting, see [Change the graphic language setting on page 28](#).
- You may not have installed in your computer the correct driver for your printer, see the *Assembly instructions*.
- If you are printing on a sheet, you must specify **Single sheet** as the paper source in your printer driver.
- The printer may be holding the job for suitable paper (see [On hold for paper on page 146](#)) or accounting ID information (see [Require account ID on page 27](#)).
- You may have requested a print preview from your printer driver. This is a function you can use to check that the image is the one you want. In this case, the preview is displayed on your screen, and you must click the **Print** button to start printing.

## Front panel fails to initialize

If the printer will not start (the front panel is blank or the diagnostic LEDs are all off), you are recommended to replace the firmware, in the following way:

1. Go to the HP Support Center (see [HP Support Center on page 184](#)) and download the firmware.
2. Save the firmware on a USB flash drive. Ideally, the USB flash drive should be empty and formatted with the FAT filesystem.
3. Ensure that the printer is turned off. Connect the USB flash drive to the Hi-Speed USB host port beside the front panel, then turn the printer on.
4. The printer takes about a minute to read the firmware file, then asks you to remove the USB flash drive.
5. The printer automatically installs the new firmware and restarts.

## Printer seems slow

Here are some possible explanations:

- Did you set the print quality to **Best** or **Maximum detail**? Best-quality and maximum detail prints take longer.
- Did you specify the correct paper type when loading the paper? Some paper types require more time for printing; for example, photo and coated papers require more drying time between passes. To find out the printer's current paper type setting, see [View information about the paper on page 44](#).
- If your printer is connected by network, check that all components used in the network interface (wired or wireless), such as hubs, routers, switches, and cables, are capable of high-speed operation. Is there a lot of traffic from other devices on the network?
- Did you specify **Extended** drying time in the front panel? Try changing the drying time to **Optimal**.

## Communication failures between computer and printer

Some symptoms are:

- The front-panel display does not show the **Receiving** message when you have sent an image to the printer.
- Your computer displays an error message when you are trying to print.
- Your computer or printer hangs (stays idle), while communication is taking place.
- Your printed output shows random or inexplicable errors (misplaced lines, partial graphics etc.)

To solve a communication problem:

- Ensure that you have selected the correct printer in your application, see [Printing on page 60](#).
- Ensure that the printer works correctly when printing from other applications.
- Remember that very large prints may take some time to receive, process and print.
- If your printer is connected to your computer through any other intermediate devices, such as switch boxes, buffer boxes, cable adapters, cable converters, and so on, try using it when connected directly to your computer.
- Try another interface cable.
- Try wired a connection if you're using wireless.
- Ensure that the graphic language setting is correct, see [Change the graphic language setting on page 28](#).
- If the printer is connected by network, check that your printer has a static IP address. If it is using DHCP, the IP address may change every time it is turned on, in which case the driver may not be able to find it.

## Cannot access the Embedded Web Server

If you have not done so already, read [Embedded Web Server on page 13](#).

From the front panel, tap , then **Security > Embedded Web Server**.

If you are using a proxy server, try bypassing the server and accessing the Web server directly:

- In Internet Explorer 6 for Windows, go to **Tools > Internet Options > Connections > LAN Settings**, and check the **Bypass proxy server for local addresses** box. Alternatively, for more precise control, click the **Advanced** button and add the printer's IP address to the list of exceptions, for which the proxy server is not used.
- In Safari for Mac OS X, go to **Safari > Preferences > Advanced** and click the **Proxies: Change Settings** button. Add the printer's IP address or its domain name to the list of exceptions, for which the proxy server is not used, in the **Bypass proxy settings for these Hosts & Domains** field.

If you still cannot connect, turn the printer off and back on with the power key on the front panel.

## Cannot access the network folder

If you have set up a network folder, but the printer cannot access it, try the following suggestions:

- Check that you have filled in each field correctly. See [Configure a network folder on page 19](#).
- Check that the printer is connected to the network.
- Check that the remote computer is switched on, working normally and connected to the network.
- Check that the folder is shared and that you have the correct permissions and functionality use of it.
- Check that you can put/read files (depending of the functionality use), to the same folder from a different computer on the network, using the printer's logon credentials.
- Check that the printer and the remote computer are in the same network subnet; if they are not, check that the network routers are configured to forward the CIFS protocol traffic (also known as Samba).

## Cannot connect to the Internet

If your printer has difficulty in connecting to the Internet, it may start the Connectivity Wizard automatically.

The Connectivity Wizard performs a series of tests automatically.

If any test fails, the printer describes the problem and recommends how to solve it. You can modify settings and rerun the test, unless the settings are protected.

## Web Services issues

For any issues with HP ePrint, see HP Connected: <http://www.hpconnected.com>.

## Automatic file system check

When you turn on the printer, you will occasionally see a front panel message: **File system check**.

A file system check is taking place; it can take up to 40 minutes. Please wait until it finishes.

---

 **CAUTION:** If you turn the printer off before the file system check has finished, the file system could be seriously damaged, making the printer's hard disk unusable. In any case, the file system check will restart from the beginning whenever you turn the printer on again.

---

A file system check is scheduled every 90 days, in order to maintain the hard disk's file system integrity.



---

**NOTE:** When the printer is powered back on, it takes about three minutes to initialize and check and prepare the printheads. However, it can take up to 40 under some conditions, for example, when the printer has not been used for a long period of time and requires more time to prepare the printheads.

---

## Alerts

Your printer can communicate two types of alerts:

- **Errors:** Mainly alerting you to the fact that the printer is unable to work normally. However, in the printer driver, errors can also alert you to conditions that could ruin the print, such as clipping, even if the printer is able to print.
- **Warnings:** Alert you when the printer needs attention either for an adjustment, such as a calibration or for a possible unprintable situation, such as a preventive maintenance or low ink.

There are four different alerts communicators within your printer's system:

- **Front-panel display:** The front panel shows only the most relevant alert at a time. In the case of a warning, it disappears after a timeout. There are permanent alerts, such as "ink cartridge low on ink", that reappear when the printer becomes idle and there is not another more severe alert.



---

**TIP:** From the front panel display you can configure paper mismatch alerts, see [Solve paper mismatch on page 82](#).

---

- **Embedded Web Server:** The upper-right corner of the Embedded Web Server window shows the printer status. If there is an alert in the printer, the status shows the alert text.
- **Driver:** The driver warns about job configuration settings that may produce a problem in the final output. If the printer is not ready to print, it displays a warning.
- **HP DesignJet Utility:** To see alerts, go to the **Overview** tab and review the **Items needing attention** list on the right-hand side.

By default, alerts are displayed only when you are printing. If alerts are enabled and there is a problem that prevents a job from completing, you see a pop-up window, which explains the reason for the problem. Follow the instructions to achieve your required result.

---

# 18 Front-panel error messages

The printer may occasionally display a system error, consisting of a numerical code of 12 digits followed by the recommended action that you should take.

In most cases you will be asked to restart the printer, because when the printer starts it can diagnose the issue better and may be able to fix it automatically. If the problem persists after restarting, you should contact your support representative and be ready to give the numerical code from the error message.

If the error message contains some other recommended action, follow the printer's instructions.

## System error log

The printer saves a log of system errors that you can access in the following way.

### Using a USB flash drive

1. Take a standard USB flash drive, formatted as FAT32.
2. Create an empty file in the USB flash drive (right-click, **New > Text Document**), and name it `pdipu_enable.log`.
3. When an error message is displayed on the front panel, insert the USB flash drive into the Hi-Speed USB host port at the front of the printer. The log is automatically copied into the drive. You can remove the USB flash drive when prompted by the front panel.
4. Contact your support representative (see [Contact HP Support on page 185](#)) to share the file created in the USB flash drive.

### Using the Embedded Web Server

1. In your Web browser, go to **`https://printer IP address/hp/device/support/serviceSupport`**.
2. Click the **Download** button to get the Diagnostic package.
3. Save the package in your computer and contact your support representative (see [Contact HP Support on page 185](#)).

---

# 19 HP Customer Care

- [Introduction](#)
- [HP Professional Services](#)
- [Customer Self Repair](#)
- [Contact HP Support](#)

## Introduction

HP Customer Care offers award-winning support to ensure you get the most from your HP DesignJet, providing comprehensive, proven support expertise and new technologies to give you unique end-to-end support. Services include setup and installation, troubleshooting tools, warranty upgrades, repair and exchange services, phone and Web support, software updates and self-maintenance services. To find out more about HP Customer Care, see [Contact HP Support on page 185](#).

To register your warranty, visit <http://register.hp.com/>.

## HP Professional Services

### HP Support Center

Enjoy a world of dedicated services and resources to ensure you always get the best performance from your HP DesignJet printers and solutions.

Join the HP community at the HP Support Center, your large-format printing community, for 24×7 access to:

- Multimedia tutorials
- Step-by-step how-to guides
- Downloads: the latest printer firmware, drivers, software, paper presets, etc.
- Technical support: online troubleshooting, customer care contacts and more
- Workflows and detailed advice for completing various printing tasks from particular software applications
- Forums for direct contact with the experts, both HP and your colleagues
- Warranty tracking online, for your peace of mind
- Latest product information: printers, supplies, accessories, software, etc.
- Supplies Center for all you need to know about ink and paper

The HP Support Center can be found at [www.hp.com/go/DesignJetT1600/support](http://www.hp.com/go/DesignJetT1600/support).

By customizing your registration for the products you have purchased and your type of business, and by setting your communication preferences, you decide the information you need.

### Download printer software

Install the printer software from <http://www.hp.com/go/DesignJetT1600/drivers>. Be sure to follow the software installation instructions.

### HP Care Packs and Warranty Extensions

HP Care Packs and Warranty Extensions allow you to extend your printer's warranty beyond the standard period.

They include remote support. On-site service is also provided if necessary, with two alternative response-time options:

- Next business day
- Same business day, within four hours (may not be available in all countries)



There is an HP Installation service that unpacks, sets up, and connects the printer for you.

For more information on HP Care Packs, see <http://cpc.ext.hp.com/portal/site/cpc>.

## Customer Self Repair

HP's Customer Self Repair program offers our customers the fastest service under either warranty or contract. It enables HP to ship replacement parts directly to you (the end user) so that you can replace them. Using this program, you can replace parts at your own convenience.

### Convenient, easy to use

- An HP Support Specialist will diagnose and assess whether a replacement part is required to address a defective hardware component.
- Replacement parts are express-shipped; most in-stock parts are shipped the very same day you contact HP.
- Available for most HP products currently under warranty or contract.
- Available in most countries.

For more information about Customer Self Repair, see <http://www.hp.com/go/selfrepair>.

## Contact HP Support

HP Support is available to you by telephone. What to do before you call:

- Review the troubleshooting suggestions in this document.
- Review the relevant driver documentation.
- If you have installed third-party software drivers and RIPs, see their documentation.
- If you call your support representative, please have the following information available to help us answer your questions more quickly:
  - The product you are using (the product number and the serial number, found on the label at the back of the product).
  - If there is an error code on the front panel, note it down; see [Front-panel error messages on page 182](#).
  - The computer you are using.
  - Any special equipment or software you are using (for example, spoolers, networks, switch-boxes, modems or special software drivers).
  - The type of interface used on your product (USB or network).
  - The software and driver name and version number that you are currently using.
  - The Printer Service information, which you can get from the Embedded Web Server. In a Web browser, enter the IP address of your printer to access the Embedded Web Server. Then click **Support > Service support > Service information > Display**. If you need to send the information by email, you can download it as a file from your browser, and later send the file.

---

 **NOTE:** After you click **Display**, your browser may prevent the pop-up window from opening. In this case, you have to find the browser option that allows the window to open.

---

Alternatively, from your browser you can send the page directly: click **File** > **Send** > **Page by email**.

## Telephone number

Your HP Support telephone number is available on the Web: see [http://welcome.hp.com/country/us/en/wwcontact\\_us.html](http://welcome.hp.com/country/us/en/wwcontact_us.html).

---

## 20 Printer specifications

- [Functional specifications](#)
- [Mobile printing specifications](#)
- [Physical specifications](#)
- [Memory specifications](#)
- [Power specifications](#)
- [Environmental specifications](#)
- [Acoustic specifications](#)

# Functional specifications

## HP ink supplies

Printhead	One printhead, with doubled nozzles for matte black
Ink cartridges	Cartridges containing 130 ml of ink: gray, photo black, matte black, yellow, magenta, and cyan  Cartridges containing 300 ml of ink: gray, photo black, matte black, yellow, magenta, and cyan

## Paper sizes

	Minimum	Maximum
Roll width	279 mm (11 in)	914 mm (36 in)
Roll length		91 m (300 ft)
Roll diameter		140 mm (5.51 in)**
Roll weight		11.9 kg (26.3 lb)
Sheet width	210 mm (8.26 in)	914 mm (36 in)
Sheet length	279 mm (11 in)	1676 mm (66 in)
Roll paper thickness		0.5 mm (19.7 mil)*
Sheet paper thickness		0.5 mm (19.7 mil)*
Paper weight	60 g/m <sup>2</sup>	328 g/m <sup>2</sup>

\* up to 0.6 mm (23.6 mil) printed to the output stacking tray with manual mode.

\*\* Roll core diameter of 51 mm (2 in). Paper with roll core diameter of 76 mm (3 in) can be used with the HP DesignJet 3-in Spindle Adaptor Kit (see [3-in Spindle Adaptor Kit on page 142](#)).

## Printing resolutions

Print quality	Maximum detail	Graphic language	Rendering resolution (ppi)	Printing resolution (dpi)
Best (photo paper*)	On	HP PLC3GUI PostScript/PDF	600 × 600	2400 × 1200
	Off	any	600 × 600	1200 × 1200
Best (other papers)	Off	any	600 × 600	1200 × 1200
Normal	Off	HP PCL3GUI, PostScript/PDF	600 × 600**	1200 × 1200
Fast (heavyweight coated, photo)	Off	HP PCL3GUI, PostScript/PDF	600 × 600**	1200 × 1200

### Printing resolutions (continued)

Print quality	Maximum detail	Graphic language	Rendering resolution (ppi)	Printing resolution (dpi)
Fast (plain, coated, natural tracing paper)	Off	HP PCL3GUI, PostScript/PDF	600 × 600**	600 × 1200
Economode	Off	any	300 × 300	600 × 1200

\* For a list of supported papers, see [Order paper on page 138](#).

\*\* Except Backlit papers ( 300 x 300 ppi).

### Margins

Top, right and left margins	5 mm (0.2 in) (default) / 3 mm (0.1 in) (optional)
Bottom margin (trailing edge)	5 mm (0.2 in) (roll) (default) / 3 mm (0.1 in) (optional) 22 mm (0.87 in) (sheet)

### Mechanical accuracy

±0.1% of the specified vector length or ±0.2 mm (whichever is greater) at 23°C (73°F), 50-60% relative humidity, on E/A0 printing material in Best or Normal mode with HP Matte Film roll feed.

### Graphic languages supported

HP DesignJet	Languages
T1600	HP PCL3GUI, HP-GL/2 and HP RTL, CALS G4, TIFF, JPEG, URF
T1600 PS	HP PCL3GUI, HP-GL/2 and HP RTL, CALS G4, TIFF, JPEG, URF, Adobe PDF 1.7, Adobe PostScript 3

## Mobile printing specifications

### Mobile printing

Mobile printing	Yes, directly from Android with HP Print Service Plugin
Mobile devices supported by HP Mobile printing	Smartphones and tablets
Supported operating systems	iOS, Android, Windows
OS Versions	iOS from 7.0 and Android from 4.4, Windows any
Connectivity requirements	Printer and mobile device must use the same network
Supported file formats	PDF, JPEG

### Email printing

Mobile devices supported	Smartphones, tablets, PC
Supported operating systems	Any, as long as it has email
Connectivity requirements	Cloud connection
Cloud features	Remote printing through email
Supported file formats	PDF, JPEG, TIFF
Max file size	10 MB

## Physical specifications

### Printer physical specifications

	HP DesignJet T1600	HP DesignJet T1600 dr
Weight	81 kg (179 lb)	85 kg (187 lb)
Width	1390 mm (54.7 in)	1390 mm (54.7 in)
Depth	920 mm (36.2 in) (stacker and basket open) 760 mm (29.9 in) (stacker and basket closed)	920 mm (36.2 in) (stacker and basket open) 760 mm (29.9 in) (stacker and basket closed)
Height	1080 mm (42.5 in) (stacker and front panel deployed) 950 mm (37.4 in) (stacker and front panel folded)	1080 mm (42.5 in) (stacker and front panel deployed) 950 mm (37.4 in) (stacker and front panel folded)

## Memory specifications

### Memory specifications

HP DesignJet	Physical DRAM	Dedicated file-processing memory	Hard disk
T1600 Printer Series	4 GB	128 GB	500 GB encrypted

## Power specifications

### Printer power specifications

Input voltage	100–240 V ac $\pm$ 10%, auto-ranging
Frequency	50/60 Hz
Maximum current	< 2 A
Power	< 100 W

## Environmental specifications

### Printer environmental specifications

Operating temperature	5 to 35°C (41 to 95°F)
Recommended operating temperature	15 to 35°C (59 to 95°F), depending on paper type
Storage temperature	–25 to 55°C (–13 to 131°F)
Recommended operating humidity	20 to 80% RH, depending on paper type
Storage humidity	0 to 95% RH

## Acoustic specifications

Declared noise emission levels for the HP DesignJet T1600 Printer Series. Sound pressure levels at bystander positions and sound power levels measured per ISO 7779.

### Printer acoustic specifications

Operating sound pressure	42 dB(A) (plain paper, line drawing, normal mode)
Operating sound power	$\leq$ 5.9 B(A) (plain paper, line drawing, normal mode)
Idle sound pressure	32 dB(A) <17 dB(A) (sleep)
Idle sound power	$\leq$ 4.9 B(A) <3.5 B(A) (sleep)

---

# Glossary

**AppleTalk**

A suite of protocols that Apple Computer developed in 1984 for computer networking. Apple now recommends TCP/IP and Bonjour networking instead. HP DesignJet products no longer support AppleTalk.

**Bonjour**

Apple Computer's trade name for its implementation of the IETF Zeroconf specification framework, a computer network technology used in Apple's Mac OS X from version 10.2 onwards. It is used to discover services available on a local area network. It was originally known as Rendezvous.

**Color accuracy**

The ability to print colors that match the original image as closely as possible, bearing in mind that all devices have a limited color gamut and may not be physically capable of matching certain colors precisely.

**Color consistency**

The ability to print the same colors from a particular print job from print to print and from printer to printer.

**Color model**

A system of representing colors by numbers, such as RGB or CMYK.

**Color space**

A color model in which each color is represented by a specific set of numbers. Many different color spaces can use the same color model: for instance, monitors generally use the RGB color model, but they have different color spaces, because a particular set of RGB numbers results in different colors on different monitors.

**Cutter**

A printer component that slides back and forth across the platen to cut the paper.

**ESD**

ElectroStatic Discharge. Static electricity is common in daily life. It is the spark when touching the car door, or the cling of clothing. Although controlled static electricity has some useful applications, uncontrolled electrostatic discharges are one of the main hazards to electronic products. Therefore, to prevent damage some precautions are needed when setting up the printer, or handling ESD sensitive devices. This type of damage may reduce the life expectancy of the device. One way to minimize uncontrolled ESDs, and therefore reduce this type of damage is by touching any exposed grounded part of the printer (mainly metal parts) before handling ESD sensitive devices (such as the printheads or ink cartridges). Additionally, to reduce the generation of electrostatic charge in your body try to avoid working in a carpeted area, and keep your body movements to a minimum when handling ESD sensitive devices. Also, avoid working in low humidity environments.

**Ethernet**

A popular computer networking technology for local area networks.

**Firmware**

Software that controls your printer's functionality and is stored semi-permanently in the printer (it can be updated).

**Gamut**

The range of colors and density values reproducible on an output device, such as a printer or monitor.



**Gigabit Ethernet**

An Ethernet network capable of transferring data at up to 1,000,000,000 bits/second. Gigabit Ethernet interfaces are capable of negotiating slower speeds when required for compatibility with older Ethernet devices.

**HP-GL/2**

HP Graphics Language 2: a language defined by HP to describe vector graphics.

**HP RTL**

HP Raster Transfer Language: a language defined by HP to describe raster (bitmap) graphics.

**I/O**

Input/Output: this term describes the passing of data between one device and another.

**ICC**

The International Color Consortium, a group of companies that have agreed on a common standard for color profiles.

**Ink cartridge**

A removable printer component that stores ink of a particular color and provides it to the printhead.

**IP address**

May mean an IPv4 address (most likely) or an IPv6 address.

**IPSec**

A sophisticated mechanism for providing network security by authenticating and encrypting IP packets sent between nodes on a network. Each network node (computer or device) has an IPSec configuration. Applications are usually unaware whether IPSec is being used or not.

**IPv4 address**

A unique identifier that identifies a particular node on an IPv4 network. An IPv4 address consists of four integers separated by full stops. Most networks in the world use IPv4 addresses.

**IPv6 address**

A unique identifier that identifies a particular node on an IPv6 network. An IPv6 address consists of up to 8 groups of hexadecimal digits separated by colons. Each group contains up to 4 hexadecimal digits. Only a few new networks in the world use IPv6 addresses.

**Jetdirect**

HP's brand name for its series of print servers that allow a printer to be connected directly to a local area network.

**LED**

Light-Emitting Diode: a semiconductor device that emits light when electrically stimulated.

**MAC address**

Media Access Control address: a unique identifier used to identify a particular device on a network. It is a lower-level identifier than the IP address. Thus, a device may have both a MAC address and an IP address.

**Network**

A network is a set of connections that pass data between computers and devices. Every device is able to communicate with every other device in the same network. This allows data to be moved between computers and devices, and allows devices such as printers to be shared between many computers.

**Nozzle**

One of many tiny holes in a printhead through which ink is deposited onto the paper.

**Paper**

A thin, flat material made to be written or printed on; most commonly made from fibers of some kind which are pulped, dried and pressed.

**Platen**

The flat surface within the printer over which the paper passes while it is being printed on.

**Printer driver**

Software that converts a print job in a generalized format into data suitable for a particular printer.

**Printhead**

A removable printer component that takes ink of one or more colors from the corresponding ink cartridge(s) and deposits it on the paper, through a cluster of nozzles. In your printer, each printhead prints two different colors.

**Spindle**

A rod that supports a roll of paper while it is being used for printing.

**TCP/IP**

Transmission Control Protocol/Internet Protocol: the communications protocols on which the Internet is based.

**USB**

Universal Serial Bus: a standard serial bus designed to connect devices to computers.

**USB host port**

A rectangular USB socket such as those on found on computers. A printer can control USB devices that are connected to such a port. Your printer has two USB host ports, which it uses to control accessories and USB flash drives.

# Index

## A

- access control 25
- accessories
  - order 141
- account ID
  - requiring 27
- accounting 115
- acoustic specifications 191
- Acrobat Pro, print 99
- Acrobat Reader, print 97
- Acrobat, print 94
- Acrobat, print multipage 95
- alerts
  - errors 181
  - warnings 181
- AutoCAD, print presentation 107
- AutoCAD, print project 104

## B

- banding problems 154
- basket 44
  - output problems 153
- black and white 91
- blurred lines 168

## C

- calibration
  - color 88
- cannot load paper 144
- caution 5
- clean the platen 161
- clean the printer 133
- clipped at bottom 164
- clipped image 164
- color
  - advantages 88
  - calibration 88
  - CMYK 88
  - inaccurate 163

- profile 88
- RGB 88
- spaces 91
- color management
  - from front panel 92
  - from printer drivers 90
  - options 90
  - process 88
- components of printer 6
- computer communication
  - printer/computer communications issues 58, 179
- configure
  - HP ePrint connectivity 17
- connect the printer
  - general 14
- cost assignment 119
- crop lines 70
- Customer Care 184
- Customer Self Repair 185
- cutter
  - on/off 47

## D

- delayed printing 59
- demo prints 13
- DHCP settings 53
- dim mode 10
- disk wipe 136
- DNS settings 53
- draft printing 69
- driver preferences 28
- drivers 27
- drying time
  - change 46

## E

- economize
  - on ink 73
  - on paper 70
- Email printing 190
- email printing
  - enable hp eprint 16
  - HP ePrint job policies 17
- Embedded Web Server 13
  - accessibility 29
  - cannot access 58, 179
  - cost assignment 119
  - job queue 83
  - usage per job 117
  - usage statistics 115
- environmental specifications 191
- erase files securely 135
- error messages
  - front panel 182
  - log 182

## F

- file erase, secure 135
- file system check 180
- firewall status 55
- firmware update 134
  - manual setup 17
- front panel 9
  - accessibility 29
  - job queue 79
  - language 11
- front panel option
  - align printheads 175
  - auto-off due to inactivity 11
  - clean printhead 175
  - display brightness 11
  - drying time 46
  - Embedded Web Server 58
  - enable 46

- form feed and cut 47
  - horizontal cutter 47
  - language 11
  - move paper 46
  - printer sleep 11
  - printhead information 124
  - printing & management 58
  - replace 121, 125
  - speaker volume 11
  - unit selection 11
  - unload paper 39
  - front panel will not start 178
  - front view 6
  - front-panel option
    - account ID required 27
    - adjust paper advance 154
    - black point compensation 92
    - calibrate paper advance 154
    - CMYK source profile 92
    - color calibration 89
    - Embedded Web Server 179
    - enable crop lines 70
    - enable economode 69
    - enable maximum detail 70
    - I/O timeout 164
    - margins layout 67
    - merge 68
    - nest options 73
    - PANTONE emulation 92
    - paper size 65
    - print diagnostic image 169
    - print in color 92
    - print in grayscale 92
    - print quality 65
    - protected paper types 73
    - pure black and white 92
    - rendering intent 92
    - reset calibration 155
    - resize 68
    - RGB source profile 92
    - select graphics language 28
    - select paper type 145, 146
  - front-panel options
    - date and time options 11
    - firmware update 11
    - language 11
    - restore factory settings 11
  - functional specifications 188
- G**
- graininess 159
  - graphic languages 189
  - gray shades 91
- H**
- hard disk specification 190
  - HP Care Packs 184
  - HP Customer Care 184
  - HP DesignJet Utility
    - access 12
  - hp eprint
    - enable 16
  - HP ePrint connectivity
    - configure 17
  - HP ePrint policies
    - printing 17
  - HP Print Preview 12
  - HP Support 185
  - HP Support Center 184
  - HP Utility
    - access 12
    - cannot access 58
- I**
- image diagnostics print 169
  - image problems
    - clipped at bottom 164
    - clipped image 164
    - missing objects 165
  - import paper preset 45
  - ink
    - economical use of 73
    - usage 117
  - ink cartridge
    - about 121
    - cannot insert 174
    - insert 122
    - maintenance 133
    - order 138
    - remove 121
    - specification 188
    - status 121
    - status messages 174
  - Internet connection
    - troubleshooting 180
  - IP address 53
  - IPSEC status 55
  - IPv6 settings 54
- J**
- job deletion 83
  - job details 81
  - job queue
    - Embedded Web Server 83
    - front panel 79
  - job queue actions 80
  - job queue options 82
  - job, when to print 81
- L**
- labels, warning 5
  - language 11
  - line length accuracy 168
  - line thickness 166
  - link speed 55
  - load paper
    - cannot load 144
    - general advice 32
    - paper not in driver 145
    - roll cannot load 144
    - roll into printer 35
    - roll onto spindle 33
    - sheet 39
    - sheet cannot load 144
  - loading paper problems 144
- M**
- maintenance kits 135
  - margins 67
    - specification 189
  - mechanical accuracy 189
  - memory specifications 190
  - Microsoft Office, print 111
  - misaligned colors 167
  - Mobile printing 190
    - print 75
  - mobile printing specifications 190
  - Mobile specifications 77
  - move the printer 133
  - multiroll printer 48
- N**
- nesting 71
    - turn on and off 72
  - network
    - connect mac 15
  - network folder
    - cannot access 180
  - network troubleshooting 56
  - networking 51

- networks
  - link speed 55
  - protocols 53
  - security settings 54

## O

- on hold for paper 146
  - enable/disable 147
- order
  - accessories 141
  - ink cartridges 138
  - paper 138
  - printhead 138
- overlapping lines 68
- overnight printing 73

## P

- page size 65
- PANTONE emulation 91
- paper
  - advance 47
  - calibrate the paper advance 154
  - cannot load 144
  - clean cut 47
  - cut after printing 153
  - displaying information 45
  - download presets 44, 45
  - economical use of 70
  - incorrect out of paper 153
  - jam due to cut strip 153
  - jam in platen 147
  - jam in stacker 152
  - loading error messages 145
  - maintenance 46
  - movement 46
  - not cut well 153
  - not flat 160
  - output problems in basket 153
  - paper not in driver 145
  - presets 44
  - print on loaded paper 68, 146
  - printed on wrong paper 146
  - retained by printer 153
  - roll loose on spindle 153
  - select type 68
  - size 65
  - sizes (max and min) 188
  - stacker unexpectedly full 152
  - usage 117
  - view information 44

- paper mismatch 82
- paper not in driver 145
- paper types 138
- pause the queue 80
- Photoshop, print 103
- Photoshop, print presentation 110
- physical specifications 190
- platen cleaning 161
- PostScript upgrade 142
- power
  - on/off 7
- power specifications 191
- preferences, Windows driver 28
- preview a print 69
- print from
  - printer driver 63
  - USB flash drive 61
- print from mobile 75
- print job
  - nesting 71
- print next 81
- print preview 69
- print quality
  - select 64
- print-quality problems
  - banding 158
  - black ink comes off 162
  - black lines on yellow 161
  - blurred lines 168
  - bottom of print 162
  - discontinuous lines 167
  - edges darker than expected 162
  - edges stepped or not sharp 162
  - general 158
  - graininess 159
  - horizontal lines 158
  - inaccurate line lengths 168
  - ink marks 161
  - line thickness 166
  - misaligned colors 167
  - paper not flat 160
  - scratching 160
  - scuffing 160
  - stepped lines 166
  - vertical lines of different colors 163
  - white spots 163
- printer
  - can't access network folder 180
- printer characteristics 2

- printer does not print 178
- printer models 2
- printer services
  - configure 15
- printer software
  - Windows installation 15
  - Windows uninstallation 15
- printer software, download 184
- printer status 133
- printer will not start 178
- printer's main components 6
- printhead
  - about 124
  - align 175
  - cannot insert 174
  - clean; purge 175
  - insert 128
  - order 138
  - remove 125
  - replace, reseal 174
  - specification 188
  - status 124
  - status messages 176
- printhead cleaner
  - specification 188
- printing 60
- printing preferences
  - default 83
- printing resolutions 188
- protect a paper type T1600dr only 73
- protocols, network 53
- Proxy Server settings 54

## Q

- quality, high 70

## R

- rear view 7
- reprint job 81
- rescale a print 68
- roll paper
  - load 35
  - spindle load 33
  - unload 38
- roll policies 81

## S

- safe mode 131
- safety labels 5
- safety precautions 3

- scale a print 68
- scratched prints 160
- scuffed prints 160
- secure file erase 135
- security 25
  - network settings 54
- sheet paper
  - load 39
- sleep mode 11
- slow printing 179
- software update 135
- software, download 184
- specifications
  - acoustic 191
  - email printing 190
  - environmental 191
  - functional 188
  - graphic languages 189
  - hard disk 190
  - ink supplies 188
  - margins 189
  - mechanical accuracy 189
  - memory 190
  - mobile 190
  - mobile printing 190
  - paper size 188
  - physical 190
  - power 191
  - printing resolutions 188
- spindle 142
  - roll load 33
- spindle adaptor kit 142
- stacker 42
- statistics
  - cost assignment 119
  - ink cartridge 121
  - usage 115
  - usage per job 117
- stepped lines 166
- store the printer 133
- support services
  - HP Care Packs 184
  - HP Customer Care 184
  - HP Support 185
  - HP Support Center 184
  - printer software 184
  - warranty extensions 184

- telephone number 186
- two rolls 48

## U

- unattended printing 73
- unload paper
  - roll 38

## W

- warning 5
- warning labels 5
- warranty extensions 184
- Web Services
  - troubleshooting 180

## T

- TCP/IP settings 53