

## Digital Still Camera

## Instruction Manual

## Cyber-shot

DSC-WX350

©2014 Sony Corporation Printed in China



4 4 7 4 0 3 5 1 1 0

## English

## Learning more about the camera ("Help Guide")



"Help Guide" is an on-line manual. Refer to it for in-depth instructions on the many functions of the camera.

- Access the Sony support page.  
<http://www.sony.net/SonyInfo/Support/>
- Select your country or region.
- Search for the model name of your camera within the support page.
  - Check the model name on the bottom of your camera.

## Checking the supplied items

The number in parentheses indicates the number of pieces.

- Camera (1)
  - Rechargeable battery pack NP-BX1 (1)
  - Micro USB cable (1)
  - AC Adaptor AC-UB10C/UB10D (1)
  - Power cord (mains lead) (not supplied in the USA, Canada and China) (1)
  - Wrist strap (1)
  - Instruction Manual (this manual) (1)
  - Wi-Fi Connection/One-touch (NFC) Guide (1)
- This Guide describes the function using Wi-Fi.

## How to use

## Inserting the battery pack

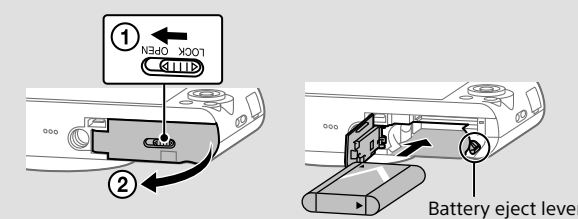

- Open the cover.
- Insert the battery pack.

## Charging the battery pack

Turn off the camera while charging the battery.

For customers in the USA, Canada and China

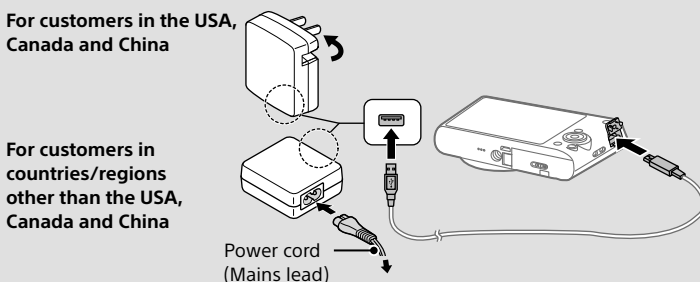

For customers in countries/regions other than the USA, Canada and China

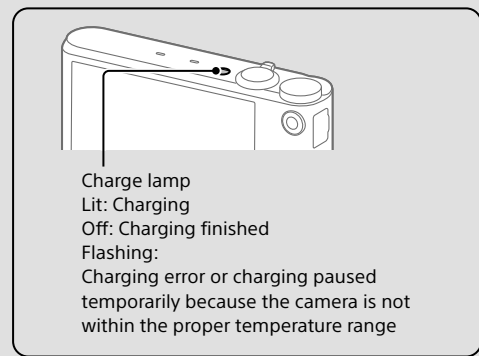

- Connect the camera to the AC Adaptor (supplied), using the micro USB cable (supplied).

- Connect the AC Adaptor to the wall outlet (wall socket).

- Be sure to use only genuine Sony brand battery packs, micro USB cable (supplied) and AC Adaptor (supplied).

## Charging time (Full charge)

The charging time is approximately 230 min. using the AC Adaptor (supplied).

## To charge by connecting to a computer

The battery pack can be charged by connecting the camera to a computer using a micro USB cable.

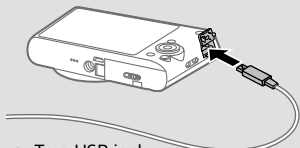

←To a USB jack

## Battery life and number of images that can be recorded and played back

	Total usage time	Number of images
Shooting (still images)	Approx. 235 min.	Approx. 470 images
Actual shooting (movies)	Approx. 70 min.	—
Continuous shooting (movies)	Approx. 100 min.	—
Viewing (still images)	Approx. 330 min.	Approx. 6600 images

\*The number is based on the CIPA standard.  
(CIPA: Camera & Imaging Products Association)

## Inserting a memory card (sold separately)

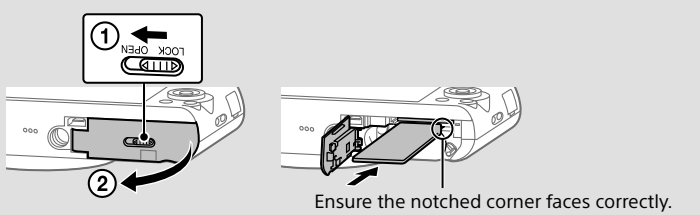

- Open the cover.
- Insert the memory card (sold separately).

## To remove the memory card/battery pack

Memory card: Push the memory card in once to eject the memory card.  
Battery pack: Slide the battery eject lever. Be sure not to drop the battery pack.

## Setting the clock

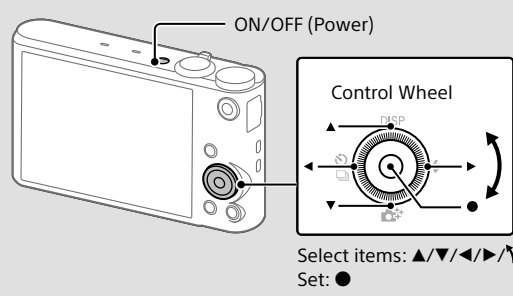

- Press the ON/OFF (Power) button.
- Check that [Enter] is selected on the screen, then press ● on the control wheel.
- Select a desired geographic location by following the on-screen instructions, then press ●.
- Set [Daylight Savings], [Date/Time] and [Date Format], then press ●.
- Check that [Enter] is selected, then press ●.

## To set the date and time again

Select MENU → (Setup) 4 → [Date/Time Setup] to open the date & time setting display.

## Shooting still images/movies

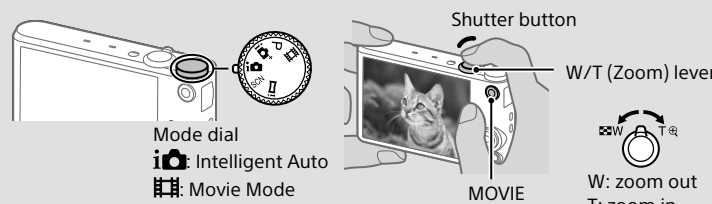

## Shooting still images

- Press the shutter button halfway down to focus.
- Press the shutter button fully down to shoot an image.

## Shooting movies

- Press the MOVIE (Movie) button to start recording.
- Press the MOVIE (Movie) button again to stop recording.

## Viewing images

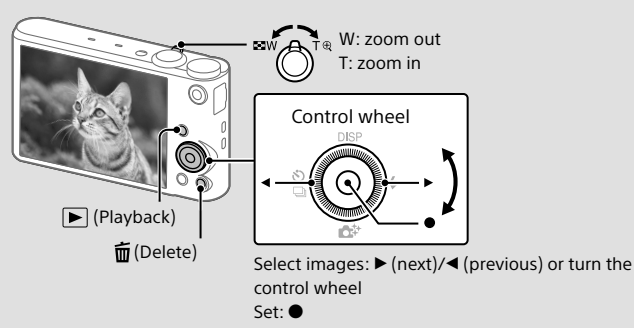

- Press (Playback) button.

## To select next/previous image

Select an image by pressing ▶ (next)/◀ (previous) on the control wheel or by turning the control wheel.  
Press ● on the control wheel to view movies.

## To delete an image

- Press (Delete) button.
- Select [Delete] with ▲ on the control wheel, then press ●.

## Features of PlayMemories Home™

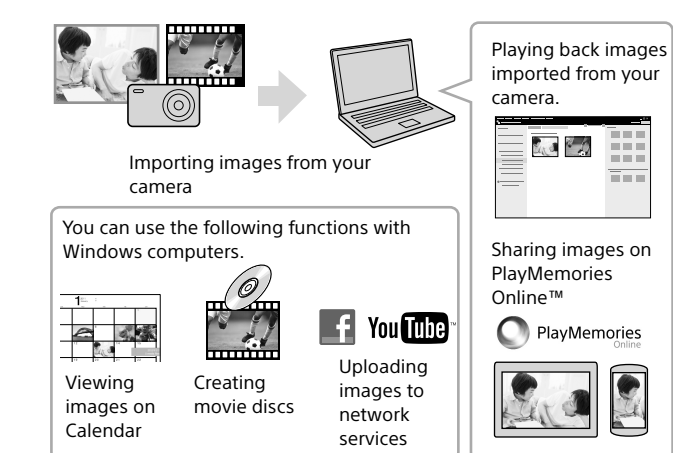

## Downloading PlayMemories Home

You can download PlayMemories Home from the following URL:  
[www.sony.net/pm/](http://www.sony.net/pm/)

- For details on applications for Mac computers, visit the following URL:  
<http://www.sony.co.jp/imsoft/Mac/>

## Recommended computer environment

You can check the system requirements for software at the following URL:  
[www.sony.net/pcenv/](http://www.sony.net/pcenv/)



## Notes on using the camera

## On use and care

Avoid rough handling, disassembling, modifying, physical shock, or impact such as hammering, dropping, or stepping on the product. Be particularly careful of the lens.

## On database files

When you insert a memory card without a database file into the camera and turn on the power, part of the memory card capacity is used to automatically create a database file. It may take some time until you can perform the next operation. If a database file error occurs, import all the images to a computer using PlayMemories Home, then format the memory card.

## Notes on recording/playback

- To ensure stable operation of the memory card, we recommend that you use this camera to format any memory card being used with this camera for the first time. Note that formatting will erase all data recorded on the memory card. This data cannot be restored. Be sure to back up any important data to a computer or other storage location.
- Before you start recording, make a trial recording to make sure that the camera is working correctly.
- The camera is neither dust-proof, nor splash-proof, nor water-proof.
- Avoid exposing the camera to water. If water enters inside the camera, a malfunction may occur. In some cases, the camera cannot be repaired.
- Do not aim the camera at the sun or other bright light. It may cause the malfunction of the camera.
- Do not use the camera near a location that generates strong radio waves or emits radiation. Otherwise, the camera may not properly record or play back images.
- Using the camera in sandy or dusty locations may cause malfunctions.
- Do not shake or strike the camera. It may cause a malfunction and you may not be able to record images. Furthermore, the recording media may become unusable or image data may be damaged.
- Clean the flash surface before use. The heat of the flash emission may cause dirt on the flash surface to start smoking or burning. Wipe the flash surface with a soft cloth to remove dirt or dust, etc.

## On camera's temperature

Your camera and battery may get hot due to continuous use, but it is not a malfunction.

## On the overheat protection

Depending on the camera and battery temperature, you may be unable to record movies or the power may turn off automatically to protect the camera. A message will be displayed on the screen before the power turns off or you can no longer record movies. In this case, leave the power off and wait until the camera and battery temperature goes down. If you turn on the power without letting the camera and battery cool enough, the power may turn off again or you may be unable to record movies.

## Note on wireless LAN

We assume no responsibility whatsoever for any damage caused by unauthorized access to, or unauthorized use of, destinations loaded on the camera, resulting from the copyright laws.

## Warning on copyright

Television programs, films, videotapes, and other materials may be copyrighted. Unauthorized recording of such materials may be contrary to the provisions of the copyright laws.

## No compensation for damaged content or recording failure

Sony cannot compensate for failure to record or loss or damage of recorded content due to a malfunction of the camera or recording media, etc.

## On moisture condensation

If the camera is brought directly from a cold to a warm location, moisture may condense inside or outside the camera. This moisture condensation may cause a malfunction of the camera.

## If moisture condensation occurs

Turn off the camera and wait about an hour for the moisture to evaporate. Note that if you attempt to shoot with moisture remaining inside the lens, you will be unable to record clear images.

## How to store the battery pack

To prevent staining the terminal, short-circuiting, etc., be sure to use a plastic bag, etc. to keep away from metal materials when carrying or storing.

## Specifications

## Camera

## [System]

Image device: 7.82 mm (1/2.3 type) Exmor R™ CMOS sensor  
Total pixel number of camera: Approx. 21.1 Megapixels  
Effective pixel number of camera: Approx. 18.2 Megapixels  
Lens: Sony G 20× zoom lens

f = 4.3 mm – 86 mm (25 mm – 500 mm (35 mm film equivalent))  
F3.5 (W) – F6.5 (T)  
While shooting movies (16:9): 27 mm – 540 mm\*  
While shooting movies (4:3): 33 mm – 660 mm\*  
\* When SteadyShot is set to [Standard]

SteadyShot: Optical  
File format:

Still images: JPEG (DCF, Exif, MPF Baseline) compliant, DPOF compatible  
Movies (AVCHD format):  
AVCHD format Ver. 2.0 compatible  
Video: MPEG-4 AVC/H.264  
Audio: Dolby Digital 2ch, equipped with Dolby Digital Stereo Creator  
• Manufactured under license from Dolby Laboratories.  
Movies (MP4 format):  
Video: MPEG-4 AVC/H.264  
Audio: MPEG-4 AAC-LC 2ch

Recording media: Memory Stick PRO Duo™ media, Memory Stick Micro™ media, SD cards, microSD memory cards

Flash: Flash range (ISO sensitivity (Recommended Exposure Index) set to Auto):  
Approx. 0.2 m to 4.3 m (7 7/8 in to 14 ft 1 3/8 in) (W)  
Approx. 2.0 m to 2.4 m (6 ft 6 3/4 in to 7 ft 10 1/2 in) (T)

## [Input and Output connectors]

HDMI connector: HDMI micro jack  
Multi/Micro USB Terminal\*: USB communication  
USB communication: Hi-Speed USB (USB 2.0)  
\* Supports Micro USB compatible device.

## [Screen]

LCD screen: 7.5 cm (3.0 type) TFT drive  
Total number of dots: 460 800 dots

## [Power, general]

Power: Rechargeable battery pack NP-BX1, 3.6 V  
AC Adaptor AC-UB10C/UB10D, 5 V  
Power consumption (during shooting): Approx. 1.0 W  
Operating temperature: 0 °C to 40 °C (32 °F to 104 °F)  
Storage temperature: –20 °C to +60 °C (–4 °F to +140 °F)  
Dimensions (CIPA compliant):  
96 mm × 54.9 mm × 25.7 mm (3 7/8 in × 2 1/4 in × 1 1/16 in) (W/H/D)

Mass (CIPA compliant) (including NP-BX1 battery pack, Memory Stick PRO Duo media):  
Approx. 164 g (5.8 oz)  
Microphone: Stereo  
Speaker: Monaural  
Exif Print: Compatible  
PRINT Image Matching III: Compatible

## [Wireless LAN]

Supported standard: IEEE 802.11 b/g/n  
Frequency: 2.4GHz

Supported security protocols: WEP / WPA-PSK/WPA2-PSK

Configuration method: WPS (Wi-Fi Protected Setup) / manual

Access method: Infrastructure Mode  
NFC: NFC Forum Type 3 Tag compliant

## AC Adaptor AC-UB10C/UB10D

Power requirements: AC 100 V to 240 V, 50 Hz/60 Hz, 70 mA  
Output voltage: DC 5 V, 0.5 A  
Operating temperature: 0 °C to 40 °C (32 °F to 104 °F)  
Storage temperature: –20 °C to +60 °C (–4 °F to +140 °F)  
Dimensions:  
Approx. 50 mm × 22 mm × 54 mm (2 in × 7/8 in × 2 1/4 in) (W/H/D)

## Rechargeable battery pack NP-BX1

Battery type: Lithium-ion battery  
Maximum voltage: DC 4.2 V  
Nominal voltage: DC 3.6 V  
Maximum charge voltage: DC 4.2 V  
Maximum charge current: 1.89 A  
Capacity: 4.5 Wh (1 240 mAh)

Design and specifications are subject to change without notice.

## Trademarks

- Memory Stick and are trademarks or registered trademarks of Sony Corporation.
- "AVCHD Progressive" and "AVCHD Progressive" logotype are trademarks of Panasonic Corporation and Sony Corporation.
- Dolby and the double-D symbol are trademarks of Dolby Laboratories.
- The terms HDMI and HDMI High-Definition Multimedia Interface, and the HDMI Logo are trademarks or registered trademarks of HDMI Licensing LLC in the United States and other countries.
- Microsoft, Windows and Windows Vista are either registered trademarks or trademarks of Microsoft Corporation in the United States and/or other countries.
- Mac is a registered trademark of Apple Inc. in the United States and other countries.
- iOS is a registered trademark or trademark of Cisco Systems, Inc.
- Android, Google Play are trademarks of Google Inc.
- Wi-Fi, the Wi-Fi logo, Wi-Fi PROTECTED SET-UP are registered trademarks of the Wi-Fi Alliance.
- iPhone and iPad are trademarks of Apple Inc., registered in the U.S. and other countries.
- The N Mark is a trademark or registered trademark of NFC Forum, Inc. in the United States and in other countries.
- DLNA and DLNA CERTIFIED are trademarks of Digital Living Network Alliance.
- SDXC logo is a trademark of SD-3C, LLC.
- Facebook and the "f" logo are trademarks or registered trademarks of Facebook, Inc.
- YouTube and the YouTube logo are trademarks or registered trademarks of Google Inc.
- In addition, system and product names used in this manual are, in general, trademarks or registered trademarks of their respective developers or manufacturers. However, the ™ or ® marks may not be described in this manual.

Additional information on this product and answers to frequently asked questions can be found at our Customer Support Website.

<http://www.sony.net/>

## Owner's Record

The model and serial numbers are located on the bottom. Record the serial number in the space provided below. Refer to these numbers whenever you call your Sony dealer regarding this product.

Model No. DSC-WX350

Serial No. \_\_\_\_\_

Model No. AC-UB10C/AC-UB10D

Serial No. \_\_\_\_\_

## WARNING

To reduce fire or shock hazard, do not expose the unit to rain or moisture.

## IMPORTANT SAFETY INSTRUCTIONS

## -SAVE THESE INSTRUCTIONS

## DANGER

## TO REDUCE THE RISK OF FIRE OR ELECTRIC SHOCK, CAREFULLY FOLLOW THESE INSTRUCTIONS

If the shape of the plug does not fit the power outlet, use an attachment plug adaptor of the proper configuration for the power outlet.

## CAUTION

## Battery pack

If the battery pack is mishandled, the battery pack can burst, cause a fire or even chemical burns.

Observe the following cautions.

- Do not disassemble.
- Do not crush and do not expose the battery pack to any shock or force such as hammering, dropping or stepping on it.
- Do not short circuit and do not allow metal objects to come into contact with the battery terminals.
- Do not expose to high temperature above 60°C (140°F) such as in direct sunlight or in a car parked in the sun.
- Do not incinerate or dispose of in fire.
- Do not handle damaged or leaking lithium ion batteries.
- Be sure to charge the battery pack using a genuine Sony battery charger or a device that can charge the battery pack.
- Keep the battery pack out of the reach of small children.
- Keep the battery pack dry.
- Replace only with the same or equivalent type recommended by Sony.
- Dispose of used battery packs promptly as described in the instructions.

## AC Adaptor

Use the nearby wall outlet (wall socket) when using the AC Adaptor. Disconnect the AC Adaptor from the wall outlet (wall socket) immediately if any malfunction occurs while using the apparatus.

The power cord (mains lead), if supplied, is designed specifically for use with this camera only, and should not be used with other electrical equipment.

## For Customers in Europe

## Notice for the customers in the countries applying EU Directives

Manufacturer: Sony Corporation, 1-7-1 Konan Minato-ku Tokyo, 108-0075 Japan  
For EU product compliance: Sony Deutschland GmbH, Hedelfinger Strasse 61, 70327 Stuttgart, Germany



Hereby, Sony Corporation, declares that this equipment is in compliance with the essential requirements and other relevant provisions of Directive 1999/5/EC. For details, please access the following URL:  
<http://www.compliance.sony.de/>

## Notice

If static electricity or electromagnetism causes data transfer to discontinue midway (fail), restart the application or disconnect and connect the communication cable (USB, etc.) again.

This product has been tested and found compliant with the limits set out in the EMC regulation for using connection cables shorter than 3 meters (9.8 feet).

The electromagnetic fields at the specific frequencies may influence the picture and sound of this unit.

## Disposal of waste batteries and electrical and electronic equipment

(applicable in the European Union and other European countries with separate collection systems)



This symbol on the product, the battery or on the packaging indicates that the product and the battery shall not be treated as household waste. On certain batteries this symbol might be used in combination with a chemical symbol. The chemical symbols for mercury (Hg) or lead (Pb) are added if the battery contains more than 0.0005% mercury or 0.004% lead. By ensuring these products and batteries are disposed of correctly, you will help prevent potentially negative consequences for the environment and human health which could otherwise be caused by inappropriate waste handling. The recycling of the materials will help to conserve natural resources.

In case of products that for safety, performance or data integrity reasons require a permanent connection with an incorporated battery, this battery should be replaced by qualified service staff only. To ensure that the battery and the electrical and electronic equipment will be treated properly, hand over these products at end-of-life to the applicable collection point for the recycling of electrical and electronic equipment. For all other batteries, please view the section on how to remove the battery from the product safely. Hand the battery over to the applicable collection point for the recycling of waste batteries. For more detailed information about recycling of this product or battery, please contact your local Civic Office, your household waste disposal service or the shop where you purchased the product or battery.

## For Customers in Singapore

Complies with  
IDA Standards  
DB00353

## For customers who purchased their camera from a store in Japan that caters to tourists

## Note

Some certification marks for standards supported by the camera can be confirmed on the screen of the camera.  
Select MENU → (Setup) 6 → [Certification Logo].  
If display is not possible due to problems such as camera failure, contact your Sony dealer or local authorized Sony service facility.