



# **iP110 series**

# **Online Manual**

Read Me First  
Useful Functions Available on the Machine  
Overview of the Printer  
Printing  
Troubleshooting

# Contents

Read Me First. . . . .	11
Symbols Used in This Document. . . . .	12
Trademarks and Licenses. . . . .	13
Search Tips. . . . .	17
Notes on Operation Explanations. . . . .	19
Useful Functions Available on the Machine. . . . .	20
Connect Wirelessly with Ease in "Access Point Mode". . . . .	21
Print Photos Easily Using My Image Garden. . . . .	22
Connection Methods Available on the Printer. . . . .	24
Connection without Using an Access Point (Windows XP). . . . .	26
Restrictions. . . . .	28
Notice for Web Service Printing. . . . .	30
Use PIXMA Cloud Link. . . . .	32
Using PIXMA Cloud Link from Your Smartphone, Tablet, or Computer. . . . .	33
Before Using Canon Inkjet Cloud Printing Center. . . . .	34
Requirements for Canon Inkjet Cloud Printing Center operation. . . . .	35
Preparations Before Using Canon Inkjet Cloud Printing Center. . . . .	37
Canon Inkjet Cloud Printing Center window. . . . .	43
Using Canon Inkjet Cloud Printing Center. . . . .	59
Adding a Printer. . . . .	63
Troubleshooting Canon Inkjet Cloud Printing Center. . . . .	64
Printing with Google Cloud Print. . . . .	66
Preparations for Printing with Google Cloud Print. . . . .	67
Printing from Computer or Smartphone with Google Cloud Print. . . . .	69
Printing from AirPrint Compliant Device. . . . .	71
Android Print. . . . .	76
Checking Printer Information. . . . .	77
Print Easily from a Smartphone or Tablet with PIXMA Printing Solutions. . . . .	79
Printing with Windows RT. . . . .	80
Overview of the Printer. . . . .	81
Safety Guide. . . . .	82

Safety Precautions. . . . .	83
Regulatory and Safety Information. . . . .	85
<b>Main Components and Basic Operations. . . . .</b>	<b>89</b>
Main Components. . . . .	90
Front View. . . . .	91
Rear View. . . . .	93
Side View. . . . .	94
Inside View. . . . .	95
About the Power Supply of the Printer. . . . .	97
Confirming that the Power Is On. . . . .	98
Turning the Printer On and Off. . . . .	99
Notice for the Power Plug/Power Cord. . . . .	101
Notice for Unplugging the Power Cord. . . . .	102
<b>Loading Paper. . . . .</b>	<b>103</b>
Loading Paper. . . . .	104
Loading Plain Paper / Photo Paper. . . . .	105
Loading Envelopes. . . . .	108
Media Types You Can Use. . . . .	111
Paper Load Limit. . . . .	113
Media Types You Cannot Use. . . . .	114
Printing Area. . . . .	115
Printing Area. . . . .	116
Other Sizes than Letter, Legal, Envelopes. . . . .	117
Letter, Legal. . . . .	118
Envelopes. . . . .	119
<b>Replacing an Ink Tank. . . . .</b>	<b>120</b>
Replacing an Ink Tank. . . . .	121
Checking the Ink Status from Your Computer. . . . .	126
Checking the Ink Status. . . . .	127
Checking the Ink Status with the Ink Lamps. . . . .	128
<b>Maintenance. . . . .</b>	<b>129</b>
When Printing Becomes Faint or Colors Are Incorrect. . . . .	130
Maintenance Procedure. . . . .	131
Printing the Nozzle Check Pattern. . . . .	133
Examining the Nozzle Check Pattern. . . . .	134
Cleaning the Print Head. . . . .	135

Aligning the Print Head. . . . .	136
Performing Maintenance from a Computer. . . . .	137
Cleaning the Print Heads from Your Computer. . . . .	138
Cleaning Inside the Printer. . . . .	140
Cleaning the Paper Feed Rollers from Your Computer. . . . .	141
Use Your Computer to Print a Nozzle Check Pattern. . . . .	142
Aligning the Print Head. . . . .	143
Aligning the Print Head Position from Your Computer. . . . .	144
Aligning the Print Head Position Manually from Your Computer. . . . .	145
Checking the Current Battery Level. . . . .	149
Cleaning the Printer. . . . .	150
Cleaning the Exterior of the Printer. . . . .	151
Cleaning the Paper Feed Roller. . . . .	152
Cleaning the Inside of the Printer (Bottom Plate Cleaning). . . . .	153
<b>Changing the Printer Settings. . . . .</b>	<b>155</b>
Changing Printer Settings from Your Computer. . . . .	156
Checking the Ink Status from Your Computer. . . . .	126
Registering a Changed Printing Profile. . . . .	158
Setting the Ink Usage Control. . . . .	160
Managing the Printer Power. . . . .	161
Reducing the Printer Noise. . . . .	163
Changing the Printer Operation Mode. . . . .	165
Changing the Machine Settings Using the Operation Panel. . . . .	167
Using the Printer with the Access Point Mode. . . . .	168
Initializing the Printer Settings. . . . .	171
Disabling the Wireless LAN Function of the Printer. . . . .	172
Setting the Ink Usage Control. . . . .	173
<b>Information about Network Connection. . . . .</b>	<b>175</b>
Useful Information about Network Connection. . . . .	176
Default Values Set at Factory (Network). . . . .	177
Connecting the Printer to the Computer Using a USB Cable. . . . .	178
When Detecting the Printers Have the Same Name. . . . .	179
Connecting to Other Computer with LAN/Changing the Connection Method from USB to LAN. . . . .	180
Printing Out Network Setting Information. . . . .	181
<b>About Network Communication. . . . .</b>	<b>183</b>
Changing and Confirming Network Settings. . . . .	184

IJ Network Tool. . . . .	185
Canon IJ Network Tool Screen. . . . .	186
Canon IJ Network Tool Menus. . . . .	188
Changing the Settings in the Wireless LAN Sheet. . . . .	190
Changing the WEP Detailed Settings. . . . .	194
Changing the WPA/WPA2 Detailed Settings. . . . .	196
Changing the Settings in the Wired LAN Sheet. . . . .	198
Changing the Settings in the Admin Password Sheet. . . . .	199
Monitoring Wireless Network Status. . . . .	201
Initializing the Network Settings of the Machine. . . . .	203
Viewing the Modified Settings. . . . .	204
Appendix for Network Communication. . . . .	205
Using the Card Slot over a Network. . . . .	206
About Technical Terms. . . . .	208
Restrictions. . . . .	215
Tips for Ensuring Optimal Printing Quality. . . . .	216
Useful Information about Ink. . . . .	217
Key Points to Successful Printing. . . . .	218
Be Sure to Make Paper Settings after Loading Paper. . . . .	219
Canceling a Print Job. . . . .	220
Printer Handling Precautions. . . . .	221
Key to Enjoying Consistent Printing Quality. . . . .	222
Precautions for Safe Transport of the Printer. . . . .	223
Legal Limitations on Use of Your Product and Use of Images. . . . .	224
Carrying the Printer. . . . .	225
Traveling Abroad with the Printer. . . . .	226
Accessories. . . . .	227
Specifications. . . . .	228
About the Administrator Password. . . . .	231
Printing. . . . .	232
Printing from a Computer. . . . .	233
Printing with Application Software that You are Using (Printer Driver). . . . .	234
Printing with Easy Setup. . . . .	235
Paper Settings on the Printer Driver. . . . .	239
Various Printing Methods. . . . .	240
Setting the Number of Copies and Printing Order. . . . .	241

Setting the Stapling Margin. . . . .	243
Execute Borderless Printing. . . . .	244
Scaling the Printing to Fit the Paper Size. . . . .	247
Scaled Printing. . . . .	249
Page Layout Printing. . . . .	250
Printing on Postcards. . . . .	252
Displaying the Print Results before Printing. . . . .	253
Setting Paper Dimensions (Custom Size). . . . .	254
Changing the Print Quality and Correcting Image Data. . . . .	255
Setting the Print Quality Level (Custom). . . . .	256
Printing a Color Document in Monochrome. . . . .	257
Specifying Color Correction. . . . .	258
Optimal Photo Printing of Image Data. . . . .	260
Adjusting Colors with the Printer Driver. . . . .	261
Printing with ICC Profiles (Specifying an ICC Profile from the Application Software). . . . .	262
Printing with ICC Profiles (Specifying an ICC Profile from the Printer Driver). . . . .	264
Adjusting Color Balance. . . . .	265
Adjusting Brightness. . . . .	267
Adjusting Intensity. . . . .	269
Adjusting Contrast. . . . .	271
Overview of the Printer Driver. . . . .	273
Canon IJ Printer Driver. . . . .	274
How to Open the Printer Driver Setup Window. . . . .	275
Page Setup Dialog. . . . .	276
Print Dialog. . . . .	277
Quality & Media. . . . .	279
Color Options. . . . .	281
Borderless Printing. . . . .	283
Margin. . . . .	284
Canon IJ Printer Utility. . . . .	285
Opening the Canon IJ Printer Utility. . . . .	287
Maintenance of this Printer. . . . .	288
Display the Printing Status Screen. . . . .	289
Deleting the Undesired Print Job. . . . .	291
Instructions for Use (Printer Driver). . . . .	292
Updating the Printer Driver. . . . .	293
Obtaining the Latest Printer Driver. . . . .	294
Delete the Unnecessary Canon IJ Printer from the Printer List. . . . .	295
Before Installing the Printer Driver. . . . .	296

Installing the Printer Driver. . . . .	297
Printing from a Digital Camera. . . . .	298
Printing Photographs Directly from a PictBridge (Wireless LAN) Compliant Device. . . . .	299
About PictBridge (Wireless LAN) Print Settings. . . . .	301
<b>Troubleshooting. . . . .</b>	<b>303</b>
<b>Problems with Network Communication. . . . .</b>	<b>304</b>
Problems with the Printer While Using with Network. . . . .	305
The Printer Stopped Working Suddenly. . . . .	306
Printing Speed Is Slow. . . . .	309
Cannot Use the Printer on Replacing an Access Point or Changing Its settings. . . . .	310
Cannot Detect a Printer on a Network. . . . .	311
Cannot Detect the Printer When Setting up Network Communication. . . . .	312
Cannot Detect the Printer during Wireless LAN Setup: Check 1. . . . .	313
Cannot Detect the Printer during Wireless LAN Setup: Check 2. . . . .	314
Cannot Detect the Printer during Wireless LAN Setup: Check 3. . . . .	315
The Printer Cannot Be Detected in the Wireless LAN. . . . .	316
Other Problems with Network. . . . .	318
Forgot an Access Point Name, SSID, or a Network Key. . . . .	319
The Message Is Displayed on the Computer Screen During Setup. . . . .	321
The Administrator Password Set to the Printer Was Forgotten. . . . .	322
Checking Information about the Network. . . . .	323
How to Restore the Printer's Network Settings to Factory Default. . . . .	325
<b>Problems with Printing. . . . .</b>	<b>326</b>
Printing Does Not Start. . . . .	327
Paper Jams. . . . .	328
Paper Does Not Feed Properly/"No Paper" Error Occurs. . . . .	329
Printing Stops Before It Is Completed. . . . .	331
<b>Problems with Printing Quality. . . . .</b>	<b>332</b>
Print Results Not Satisfactory. . . . .	333
Cannot Print to End of Job. . . . .	334
No Printing Results/Printing Is Blurred/Colors Are Wrong/White Streaks. . . . .	335
Lines Are Misaligned. . . . .	337
Printed Paper Curls or Has Ink Blots. . . . .	338
Paper Is Smudged/Printed Surface Is Scratched. . . . .	339
Back of the Paper Is Smudged. . . . .	342
Colors Are Uneven or Streaked. . . . .	343

Ink Is Not Ejected. . . . .	345
<b>Problems with the Printer. . . . .</b>	<b>346</b>
The Printer Cannot Be Powered On. . . . .	347
The Printer Turns Off Unintentionally. . . . .	348
Cannot Connect to Computer with a USB Cable Properly. . . . .	349
Cannot Communicate with the Printer with USB Connection. . . . .	350
Print Head Holder Does Not Move to the Position for Replacing. . . . .	351
<b>Problems with Installation/Downloading. . . . .</b>	<b>352</b>
Cannot Install the Printer Driver. . . . .	353
Uninstalling IJ Network Tool. . . . .	354
<b>About Errors/Messages Displayed. . . . .</b>	<b>355</b>
If an Error Occurs. . . . .	356
A Message Is Displayed. . . . .	359
Error Message Appears on a PictBridge (Wireless LAN) Compliant Device. . . . .	361
<b>If You Cannot Resolve the Problem. . . . .</b>	<b>363</b>
<b>Support Code List. . . . .</b>	<b>364</b>
<b>Support Code List (When Paper Is Jammed). . . . .</b>	<b>365</b>
1300. . . . .	366
Paper Is Jammed inside the Printer. . . . .	368
In Other Cases. . . . .	371
1000. . . . .	372
1200. . . . .	373
1401. . . . .	374
1403. . . . .	375
1405. . . . .	376
1410. . . . .	377
1411. . . . .	378
1600. . . . .	379
1660. . . . .	380
1681. . . . .	381
1687. . . . .	382
1688. . . . .	383
1689. . . . .	384
1700. . . . .	385



1701.....	386
1810.....	387
2100.....	388
2101.....	389
2103.....	390
2500.....	391
4103.....	392
5100.....	393
5200.....	394
5400.....	395
5700.....	396
5B00.....	397
5B01.....	398
5C00.....	399
6000.....	400
6500.....	401
6800.....	402
6801.....	403
6900.....	404
6901.....	405
6902.....	406
6910.....	407
6911.....	408
6930.....	409
6931.....	410
6932.....	411
6933.....	412
6940.....	413
6941.....	414
6942.....	415
6943.....	416
6944.....	417
6945.....	418
6946.....	419

6A00.....	420
A000.....	421
A100.....	422
B201.....	423
B202.....	424
B203.....	425
B204.....	426

# Read Me First

■ [Notes on Online Manual Usage](#)

■ [How to Print](#)

## Notes on Online Manual Usage

- Reproduction, diversion or copying of any text, photo or image published in the *Online Manual* (hereinafter referred to as "this guide"), in whole or in part, is prohibited.
- In principle, Canon shall change or delete the contents of this guide without prior notice to customers. In addition, Canon may suspend or stop the disclosure of this guide due to unavoidable reasons. Canon shall not be liable for any damage suffered by customers as a result of changes in or deletion of information in this guide, or suspension/stoppage of disclosure of this guide.
- Although the contents of this guide have been prepared with utmost care, please contact the service center if you find any incorrect or missing information.
- In principle, the descriptions in this guide are based on the product at the time of its initial sale.
- This guide does not disclose the manuals of all the products sold by Canon. See the manual supplied with the product when using a product that is not described in this guide.

## How to Print

Use the print function of your Web browser to print this guide.

To print background colors and images, follow the steps below to display the Print dialog options, then select the **Print backgrounds** checkbox.

1. Click **Print...** from the **File** menu.
2. Click **Show Details** or  (Down Arrow).
3. Select **Safari** from the pop-up menu.

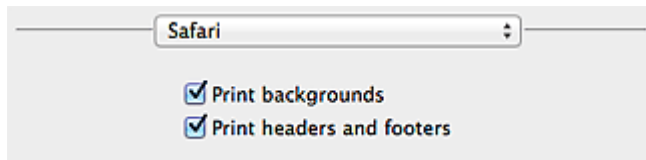

## Symbols Used in This Document

### **Warning**

Instructions that, if ignored, could result in death or serious personal injury caused by incorrect operation of the equipment. These must be observed for safe operation.

### **Caution**

Instructions that, if ignored, could result in personal injury or material damage caused by incorrect operation of the equipment. These must be observed for safe operation.

### **Important**

Instructions including important information. To avoid damage and injury or improper use of the product, be sure to read these indications.

### **Note**

Instructions including notes for operation and additional explanations.

### **Basic**

Instructions explaining basic operations of your product.

### **Note**

- Icons may vary depending on your product.

## Trademarks and Licenses

- Microsoft is a registered trademark of Microsoft Corporation.
- Windows is a trademark or registered trademark of Microsoft Corporation in the U.S. and/or other countries.
- Windows Vista is a trademark or registered trademark of Microsoft Corporation in the U.S. and/or other countries.
- Internet Explorer is a trademark or registered trademark of Microsoft Corporation in the U.S. and/or other countries.
- Mac, Mac OS, AirPort, Safari, Bonjour, iPad, iPhone and iPod touch are trademarks of Apple Inc., registered in the U.S. and other countries. AirPrint and the AirPrint logo are trademarks of Apple Inc.
- IOS is a trademark or registered trademark of Cisco in the U.S. and other countries and is used under license.
- Google Cloud Print, Google Chrome, Android, Google Play and Picasa are either registered trademarks or trademarks of Google Inc.
- Adobe, Photoshop, Photoshop Elements, Lightroom, Adobe RGB and Adobe RGB (1998) are either registered trademarks or trademarks of Adobe Systems Incorporated in the United States and/or other countries.
- Photo Rag is a trademark of Hahnemühle FineArt GmbH.
- Bluetooth is a trademark of Bluetooth SIG, Inc., U.S.A. and licensed to Canon Inc.

### Note

- The formal name of Windows Vista is Microsoft Windows Vista operating system.

Copyright (c) 2003-2004, Apple Computer, Inc. All rights reserved.

Redistribution and use in source and binary forms, with or without modification, are permitted provided that the following conditions are met:

1. Redistributions of source code must retain the above copyright notice, this list of conditions and the following disclaimer.
2. Redistributions in binary form must reproduce the above copyright notice, this list of conditions and the following disclaimer in the documentation and/or other materials provided with the distribution.
3. Neither the name of Apple Computer, Inc. ("Apple") nor the names of its contributors may be used to endorse or promote products derived from this software without specific prior written permission.

THIS SOFTWARE IS PROVIDED BY APPLE AND ITS CONTRIBUTORS "AS IS" AND ANY EXPRESS OR IMPLIED WARRANTIES, INCLUDING, BUT NOT LIMITED TO, THE IMPLIED WARRANTIES OF MERCHANTABILITY AND FITNESS FOR A PARTICULAR PURPOSE ARE DISCLAIMED. IN NO EVENT SHALL APPLE OR ITS CONTRIBUTORS BE LIABLE FOR ANY DIRECT, INDIRECT, INCIDENTAL, SPECIAL, EXEMPLARY, OR CONSEQUENTIAL DAMAGES (INCLUDING, BUT NOT LIMITED TO, PROCUREMENT OF SUBSTITUTE GOODS OR SERVICES; LOSS OF USE, DATA, OR PROFITS; OR BUSINESS INTERRUPTION) HOWEVER CAUSED AND ON ANY THEORY OF LIABILITY, WHETHER IN CONTRACT, STRICT LIABILITY, OR TORT INCLUDING NEGLIGENCE OR OTHERWISE) ARISING IN ANY WAY OUT OF THE USE OF THIS SOFTWARE, EVEN IF ADVISED OF THE POSSIBILITY OF SUCH DAMAGE.

Apache License

Version 2.0, January 2004

<http://www.apache.org/licenses/>

TERMS AND CONDITIONS FOR USE, REPRODUCTION, AND DISTRIBUTION

1. Definitions.

"License" shall mean the terms and conditions for use, reproduction, and distribution as defined by Sections 1 through 9 of this document.

"Licensor" shall mean the copyright owner or entity authorized by the copyright owner that is granting the License.

"Legal Entity" shall mean the union of the acting entity and all other entities that control, are controlled by, or are under common control with that entity. For the purposes of this definition, "control" means (i) the power, direct or indirect, to cause the direction or management of such entity, whether by contract or otherwise, or (ii) ownership of fifty percent (50%) or more of the outstanding shares, or (iii) beneficial ownership of such entity.

"You" (or "Your") shall mean an individual or Legal Entity exercising permissions granted by this License.

"Source" form shall mean the preferred form for making modifications, including but not limited to software source code, documentation source, and configuration files.

"Object" form shall mean any form resulting from mechanical transformation or translation of a Source form, including but not limited to compiled object code, generated documentation, and conversions to other media types.

"Work" shall mean the work of authorship, whether in Source or Object form, made available under the License, as indicated by a copyright notice that is included in or attached to the work (an example is provided in the Appendix below).

"Derivative Works" shall mean any work, whether in Source or Object form, that is based on (or derived from) the Work and for which the editorial revisions, annotations, elaborations, or other modifications represent, as a whole, an original work of authorship. For the purposes of this License, Derivative Works shall not include works that remain separable from, or merely link (or bind by name) to the interfaces of, the Work and Derivative Works thereof.

"Contribution" shall mean any work of authorship, including the original version of the Work and any modifications or additions to that Work or Derivative Works thereof, that is intentionally submitted to Licensor for inclusion in the Work by the copyright owner or by an individual or Legal Entity authorized to submit on behalf of the copyright owner. For the purposes of this definition, "submitted" means any form of electronic, verbal, or written communication sent to the Licensor or its representatives, including but not limited to communication on electronic mailing lists, source code control systems, and issue tracking systems that are managed by, or on behalf of, the Licensor for the purpose of discussing and improving the Work, but excluding communication that is conspicuously marked or otherwise designated in writing by the copyright owner as "Not a Contribution."

"Contributor" shall mean Licensor and any individual or Legal Entity on behalf of whom a Contribution has been received by Licensor and subsequently incorporated within the Work.

2. Grant of Copyright License. Subject to the terms and conditions of this License, each Contributor hereby grants to You a perpetual, worldwide, non-exclusive, no-charge, royalty-free, irrevocable copyright license to reproduce, prepare Derivative Works of, publicly display, publicly perform, sublicense, and distribute the Work and such Derivative Works in Source or Object form.
3. Grant of Patent License. Subject to the terms and conditions of this License, each Contributor hereby grants to You a perpetual, worldwide, non-exclusive, no-charge, royalty-free, irrevocable (except as stated in this section) patent license to make, have made, use, offer to sell, sell, import, and otherwise transfer the Work, where such license applies only to those patent claims licensable by such Contributor that are necessarily infringed by their Contribution(s) alone or by combination of

their Contribution(s) with the Work to which such Contribution(s) was submitted. If You institute patent litigation against any entity (including a cross-claim or counterclaim in a lawsuit) alleging that the Work or a Contribution incorporated within the Work constitutes direct or contributory patent infringement, then any patent licenses granted to You under this License for that Work shall terminate as of the date such litigation is filed.

4. Redistribution. You may reproduce and distribute copies of the Work or Derivative Works thereof in any medium, with or without modifications, and in Source or Object form, provided that You meet the following conditions:
  1. You must give any other recipients of the Work or Derivative Works a copy of this License; and
  2. You must cause any modified files to carry prominent notices stating that You changed the files; and
  3. You must retain, in the Source form of any Derivative Works that You distribute, all copyright, patent, trademark, and attribution notices from the Source form of the Work, excluding those notices that do not pertain to any part of the Derivative Works; and
  4. If the Work includes a "NOTICE" text file as part of its distribution, then any Derivative Works that You distribute must include a readable copy of the attribution notices contained within such NOTICE file, excluding those notices that do not pertain to any part of the Derivative Works, in at least one of the following places: within a NOTICE text file distributed as part of the Derivative Works; within the Source form or documentation, if provided along with the Derivative Works; or, within a display generated by the Derivative Works, if and wherever such third-party notices normally appear. The contents of the NOTICE file are for informational purposes only and do not modify the License. You may add Your own attribution notices within Derivative Works that You distribute, alongside or as an addendum to the NOTICE text from the Work, provided that such additional attribution notices cannot be construed as modifying the License.

You may add Your own copyright statement to Your modifications and may provide additional or different license terms and conditions for use, reproduction, or distribution of Your modifications, or for any such Derivative Works as a whole, provided Your use, reproduction, and distribution of the Work otherwise complies with the conditions stated in this License.

5. Submission of Contributions. Unless You explicitly state otherwise, any Contribution intentionally submitted for inclusion in the Work by You to the Licensor shall be under the terms and conditions of this License, without any additional terms or conditions. Notwithstanding the above, nothing herein shall supersede or modify the terms of any separate license agreement you may have executed with Licensor regarding such Contributions.
6. Trademarks. This License does not grant permission to use the trade names, trademarks, service marks, or product names of the Licensor, except as required for reasonable and customary use in describing the origin of the Work and reproducing the content of the NOTICE file.
7. Disclaimer of Warranty. Unless required by applicable law or agreed to in writing, Licensor provides the Work (and each Contributor provides its Contributions) on an "AS IS" BASIS, WITHOUT WARRANTIES OR CONDITIONS OF ANY KIND, either express or implied, including, without limitation, any warranties or conditions of TITLE, NON-INFRINGEMENT, MERCHANTABILITY, or FITNESS FOR A PARTICULAR PURPOSE. You are solely responsible for determining the appropriateness of using or redistributing the Work and assume any risks associated with Your exercise of permissions under this License.
8. Limitation of Liability. In no event and under no legal theory, whether in tort (including negligence), contract, or otherwise, unless required by applicable law (such as deliberate and grossly negligent acts) or agreed to in writing, shall any Contributor be liable to You for damages, including any direct, indirect, special, incidental, or consequential damages of any character arising as a result of this License or out of the use or inability to use the Work (including but not limited to damages for loss of

goodwill, work stoppage, computer failure or malfunction, or any and all other commercial damages or losses), even if such Contributor has been advised of the possibility of such damages.

9. **Accepting Warranty or Additional Liability.** While redistributing the Work or Derivative Works thereof, You may choose to offer, and charge a fee for, acceptance of support, warranty, indemnity, or other liability obligations and/or rights consistent with this License. However, in accepting such obligations, You may act only on Your own behalf and on Your sole responsibility, not on behalf of any other Contributor, and only if You agree to indemnify, defend, and hold each Contributor harmless for any liability incurred by, or claims asserted against, such Contributor by reason of your accepting any such warranty or additional liability.

END OF TERMS AND CONDITIONS



Enter keywords in the search window and click  (Search).

You can search for target pages in this guide.

## Search Tips

You can search for target pages by entering keywords in the search window.

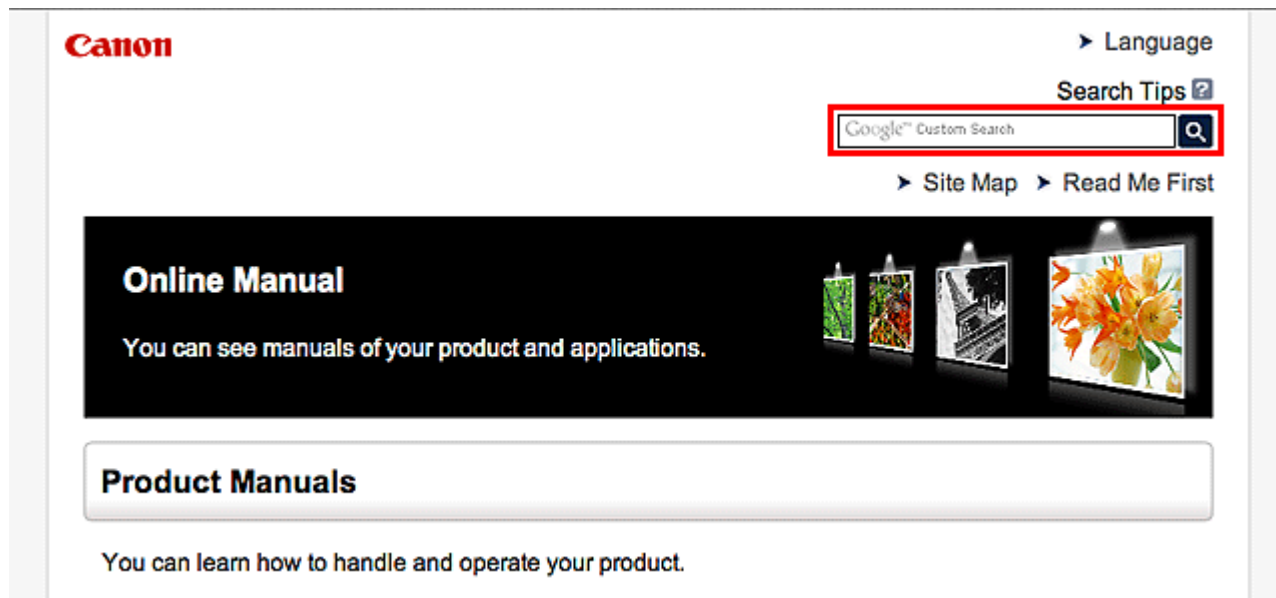

### ►► Note

- The displayed screen may vary.
- When searching from this page or the "Home" page without entering your product's model name or your application's name, all products supported by this guide will be considered for the search. If you want to narrow down the search results, add your product's model name or your application's name to the keywords.

#### • **Searching for Functions**

Enter your product's model name and a keyword for the function you want to learn about

Example: When you want to learn how to load paper

Enter "(your product's model name) load paper" in the search window and perform a search

#### • **Troubleshooting Errors**

Enter your product's model name and a support code

Example: When the following error screen appears

Enter "(your product's model name) 1000" in the search window and perform a search

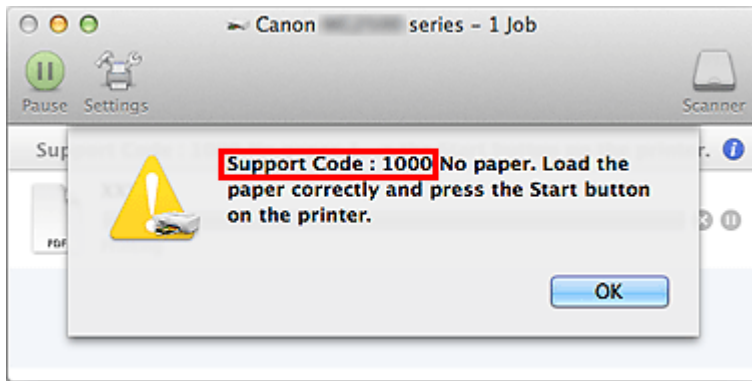

## ►►► Note

- The displayed screen varies depending on your product.

### • **Searching for Application Functions**

Enter your application's name and a keyword for the function you want to learn about

Example: When you want to learn how to print collages with My Image Garden

Enter "My Image Garden collage" in the search window and perform a search

### • **Searching for Reference Pages**

Enter your model name and a reference page title\*

\* You can find reference pages more easily by entering the function name as well.

Example: When you want to browse the page referred to by the following sentence on a scanning procedure page

Refer to "Color Settings Tab" for your model from Home of the *Online Manual* for details.

Enter "(your product's model name) scan Color Settings Tab" in the search window and perform a search

## Notes on Operation Explanations

In this guide, most of the operations are described based on the windows displayed when OS X Mavericks v10.9 is used.

## **Useful Functions Available on the Machine**

- **Connect Wirelessly with Ease in "Access Point Mode"**
- **Print Photos Easily Using My Image Garden**
- **Connection Methods Available on the Printer**
- **Notice for Web Service Printing**
- **Use PIXMA Cloud Link**
- **Printing with Google Cloud Print**
- **Printing from AirPrint Compliant Device**
- **Android Print**
- **Checking Printer Information**
- **Print Easily from a Smartphone or Tablet with PIXMA Printing Solutions**
- **Printing with Windows RT**

## Connect Wirelessly with Ease in "Access Point Mode"

The printer supports "access point mode" in which you can connect to the printer wirelessly from a computer or smartphone even in an environment without an access point or wireless LAN router.

Switch to "access point mode" with simple steps to enjoy printing wirelessly.

When you use the printer with the access point mode, be sure to specify the access point name of the printer and the security setting in advance.

### ■ [Using the Printer with the Access Point Mode](#)



# Print Photos Easily Using My Image Garden

## Organize Images Easily

In My Image Garden, you can register the names of people and events to photos. You can organize photos easily as you can display them not only by folder but also by calendar, event, and person. This also allows you to find the target photos easily when you search for them later on.

<Calendar View>



<People View>

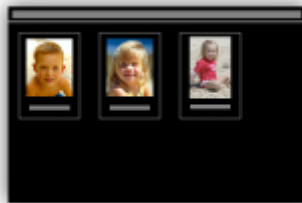

## Display Recommended Items in Slide Shows

Based on the information registered to photos, Quick Menu automatically selects the photos on your computer and creates recommended items such as collages and cards. The created items appear in slide shows.



If there is an item you like, you can easily print it in just two steps.

1. In Image Display of Quick Menu, select the item you want to print.
2. Print the item with My Image Garden.



## Place Photos Automatically

Delightful items are created easily as the selected photos are placed automatically according to the theme.



## Other Various Functions

My Image Garden has many other useful functions.

Refer to "What You Can Do with My Image Garden" for details.

# Connection Methods Available on the Printer

The following connection methods are available on the printer.

## Wireless Connection

### With an access point



### Without an access point



## USB Connection



## Wireless Connection

There are two methods for connecting the printer to your device (such as a smartphone). One method is to connect using an access point, and the other method is to connect without using an access point. The two connection methods cannot be used at the same time.

If you have an access point (or wireless network router), it is recommended that you use the method described in Connection Using an Access Point.

When connecting another device while a device is already connected to the printer, connect it using the same connection method as the connected device.

If you connect using a different connection method, the connection to the device in use will be disabled.

## Connection Using an Access Point



- Connect the printer and a device using an access point.
- Connection methods vary depending on the access point type.
- You can change network settings such as the SSID and security protocol on the printer.
- When the connection between a device and an access point is completed and  (Wi-Fi icon) is displayed in the device's screen, you can connect the device to the printer using the access point.



## Connection without Using an Access Point



- Connect the printer and a device without using an access point. Connect a device and the printer directly using the printer's access point mode function.
- When establishing a connection in access point mode, Internet connection may become unavailable. In that case, web services for the printer cannot be used.
- If you connect a device connected to the Internet via an access point to the printer that is in access point mode, the connection between the device and access point will be disabled. In that case, the connection of the device may switch to a mobile data connection automatically depending on your device. Transmission fees for connecting to the Internet using a mobile data connection apply.
- In access point mode, you can connect up to five devices at the same time. If you try to connect a sixth device while five devices are already connected, an error will appear. If an error appears, disconnect a device that does not use the printer, then configure settings again.
- Network settings such as the SSID and security protocol can be changed on the printer.

When Using Windows XP:

Connection without Using an Access Point (Windows XP)

Restrictions

(Appears in a new window)

## USB Connection

Connect the printer and a computer with a USB cable. Prepare a USB cable.

## Connection without Using an Access Point (Windows XP)

### Restrictions

(Appears in a new window)

1. Hold down the **Wi-Fi** button (A) on the printer until the **POWER** lamp (B) flashes 3 times, then release the **Wi-Fi** button after the third flash.

The printer's access point mode will be enabled.

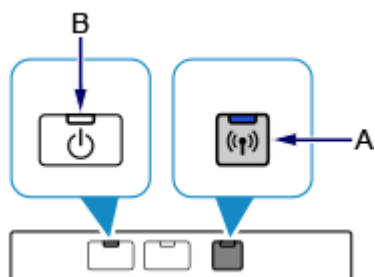

2. Check the SSID and network key of your printer.

Print the LAN setting information and check the SSID and password (network key) fields.

- **How to print the LAN setting information**

Hold down the **RESUME/CANCEL** button on the printer until the **POWER** lamp flashes 6 times, then release the **RESUME/CANCEL** button after the sixth flash.

The LAN setting information will be printed.

3. Right-click the **Wireless Network Connection** icon in the notification area of the taskbar on the computer, then select **View Available Wireless Networks**.



4. Select the network name (SSID) you want to use, then click **Connect**.

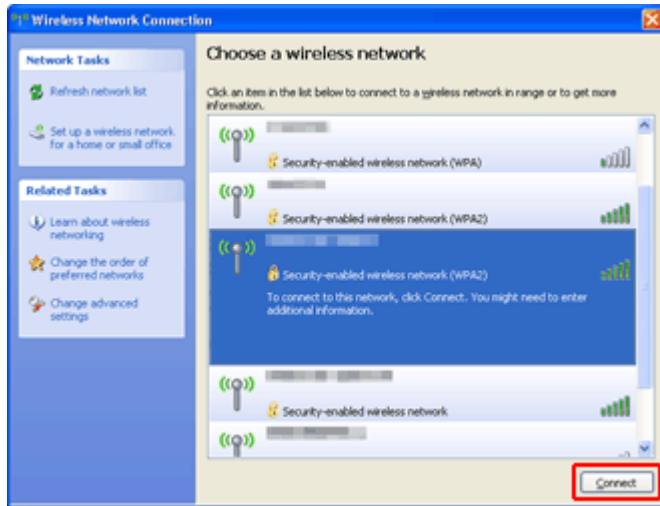

5. Enter the network key, then click **Connect**.

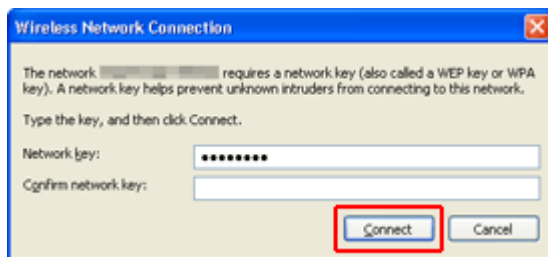

6. When connection is complete, click **Back** until the screen below appears. Proceed with the setup.

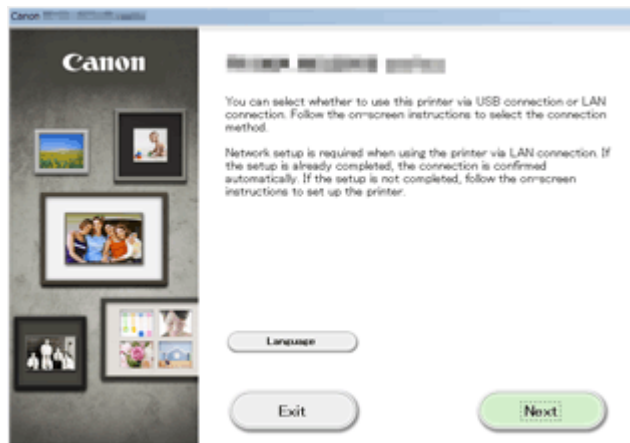

## Restrictions

When connecting another device while a device (such as a smartphone) is already connected to the printer, connect it using the same connection method as the connected device.

If you connect using a different connection method, the connection to the device in use will be disabled.

Connection Using a Wired Network cannot be performed on printers that do not support a wired connection.

## Connection Using an Access Point

- Make sure that a device and an access point (or wireless network router) are connected. For details on how to check the settings, refer to the manual supplied with the access point or contact its manufacturer.

As for a device already connected to the printer without using an access point, reconnect it via an access point.

- The configuration, router functions, setup procedures and security settings of the network device vary depending on your system environment. For details, refer to the manual of your network device or contact its manufacturer.
- Check if your device supports IEEE802.11n (2.4 GHz), IEEE802.11g or IEEE802.11b.
- If your device is set to the "IEEE802.11n only" mode, WEP or TKIP cannot be used as a security protocol. Change the security protocol for your device to something other than WEP and TKIP or change the setting to something other than "IEEE802.11n only."

The connection between your device and the access point will be temporarily disabled while changing the setting. Do not operate the screen of this guide until the setup is complete.

- For office use, consult your network administrator.
- Take added care when connecting to a network that is not protected with security measures, as there is a risk of disclosing data such as your personal information to a third party.

## Connection without Using an Access Point

### ▶▶▶ Important

- If you connect a device connected to the Internet via an access point to the printer that is in access point mode, the connection between the device and access point will be disabled. In that case, the connection of the device may switch to a mobile data connection automatically depending on your device. When you connect to the Internet using a mobile data connection, charges may apply depending on your contract.
  - When you connect a device and the printer in access point mode, the connection information will be saved to Wi-Fi settings. The device may be connected to the printer automatically even after disconnecting it or connecting it to another access point.
  - You cannot connect to an access point and the printer that is in access point mode at the same time. If you have an access point, it is recommended that you use the access point to connect to the printer.
  - To prevent automatic connection to the printer that is in access point mode, change the connection mode after using the printer, or set not to connect automatically in the Wi-Fi settings of the device.

For details on how to change the settings of a device, refer to the manual supplied with the device or contact its manufacturer.

- When connecting a device and the printer in access point mode, Internet connection may become unavailable. In that case, web services for the printer cannot be used.
- In access point mode, you can connect up to five devices at the same time. If you try to connect a sixth device while five devices are already connected, an error will appear.  
If an error appears, disconnect a device that does not use the printer, then configure settings again.
- Devices connected to the printer in access point mode cannot communicate with each other.
- Firmware updates for the printer are not available while using the access point mode.
- When a device has been connected to the printer without using an access point and you want to set it up again using the same connection method, disconnect it first. Disable the connection between the device and printer in the Wi-Fi setting screen.

## **Connection Using a Wired Network**

- This printer cannot be used over wireless and wired connections at the same time.
- When using a router, connect the printer and a device to the LAN side (same network segment).

# Notice for Web Service Printing

## When Using Web Service

- Canon does not guarantee the continuity and reliability of the web services provided, the availability of site access, or permission to download the materials.
- Canon may at any time update, change, or delete the information provided through the web service, or may suspend or discontinue the service without prior notice. Canon shall not be held responsible for any damages resulting from such actions.
- In no event shall Canon be liable for any damages whatsoever resulting from the use of the web services.
- User registration is necessary before using the photo sharing site.  
When you use the photo sharing site, observe the conditions of use of the site and use the service within your own responsibility.
- All or part of the web service may not be available depending on the country or region you live in.
- Depending on your network environment, some functions on web service are not available. Even if they are available, it may take a while to print or display the contents, or communication may be interrupted while operation is in progress.
- When you use web service, your machine's name, information of your region or country, your selected language, and what kind of service you use (e.g. photo sharing site) are sent to and saved in our server. Canon is unable to identify specific customers using this information.
- Your login name and password for the photo sharing site are saved in the machine's memory (not encrypted).  
If you hand over the machine to anyone or dispose of it, delete your login name and password from the machine's memory in advance.
- The account information will be sent to Canon Inc. server (located in Japan), then forwarded to the service provider's server.
- Canon handles your account information as follows:
  - Your account information will be used in personal identification process of the selected service.
  - Canon will not provide your account information to any third party without your consent, except for sending to the service provider or providing based on laws and regulations.
  - After the conclusion of non-disclosure agreement, Canon may deposit your account information to the contractor to achieve the purpose of use.
  - Canon endeavors to secure the safety of your account information.
  - It is at your option to enter and send your account information. However, the service that requires to enter your account information is not available unless you enter and send it.
  - Your account information does not remain in Canon Inc. server. At the latest, it will be deleted when you have disconnected your printer from LAN.
  - For details, contact a Canon-authorized sales representative in the country or region you live in.

## Copyrights and Rights of Publicity

### When printing from the photo sharing site:

- Observe the conditions of use of the photo sharing site when you use photos on the site.
- It is unlawful to reproduce or edit the copyrighted work of another person without permission from the copyright holder, except for personal use, use within the home, or other use within the limited scope as defined by the copyright. Additionally, reproducing or editing photographs of people may infringe on Rights of Publicity.

**When printing downloaded template forms:**

1. The copyright of each material (photos, illustrations, logos, or documents: hereinafter referred to as "the materials") provided on the web template printing service belongs to their respective owners. Issues pertaining to Rights of Publicity may arise regarding the use of any of people or characters displayed on the web template printing service.

Except as otherwise permitted (please see "2" below), copying, modifying or distributing all or a portion of any of the materials contained on the web template printing service without prior consent of the respective rights (Rights of Publicity and Copyright) holder is strictly prohibited.

2. All of the materials provided on the web template printing service can be freely used for personal and non-commercial purposes.

## Use PIXMA Cloud Link

By using PIXMA Cloud Link, you can connect your printer to a cloud service, such as CANON iIMAGE GATEWAY, Evernote, or Twitter, and use the following functions from your printer or from the web browser on your smartphone, tablet, or computer.

- Print images from a photo-sharing service
- Print documents from a data management service
- Use Twitter to report the printer status, such as no paper or low ink levels.

In addition, you can use various functions by adding and registering apps that are linked with various cloud services.

### ■ [Using PIXMA Cloud Link from Your Smartphone, Tablet, or Computer](#)



### ▶▶▶ Important

- In certain countries, PIXMA Cloud Link may not be available or the available apps may be different.
- Some apps require that you have an account before you use those apps. For such apps, please set up an account beforehand.
- To find out which models support PIXMA Cloud Link check the Canon homepage.
- The screen display may change without prior notice.



## **Using PIXMA Cloud Link from Your Smartphone, Tablet, or Computer**

- ▶ **Before Using Canon Inkjet Cloud Printing Center**
- ▶ **Preparations Before Using Canon Inkjet Cloud Printing Center**
- ▶ **Using Canon Inkjet Cloud Printing Center**
- ▶ **Adding a Printer**
- ▶ **Troubleshooting Canon Inkjet Cloud Printing Center**

## Before Using Canon Inkjet Cloud Printing Center

Canon Inkjet Cloud Printing Center is a service that links with the cloud function of the printer and allows you to perform operations such as registering and managing apps from your smartphone or tablet device, and checking the print status, print error, and ink status of the printer. You can also print app photos and documents from your smartphone or tablet.

First, check the following content:

- **Precautions**

If you plan to use the web service to print documents, be sure to check these [precautions](#) beforehand.

- **Printer specification**

Check that Canon Inkjet Cloud Printing Center supports the printer.

- **Network environment**

The printer must be connected to a LAN and to the Internet.

### ▶▶▶ Important

- The user will bear the cost of Internet access.

- **Operating requirements**

For computers, smartphones, and tablet devices, see "[Requirements for Canon Inkjet Cloud Printing Center operation](#)".

### ▶▶▶ Important

- This service may not be available in certain countries or regions. Also even if the service is available, there are apps that cannot be used in certain regions.

#### ■ [Preparations Before Using Canon Inkjet Cloud Printing Center](#)

# Requirements for Canon Inkjet Cloud Printing Center operation

## Computer

<b>CPU</b>	x86 or x64 1.6 GHz or higher
<b>RAM</b>	2 GB or higher
<b>Monitor display</b>	Resolution 1024 x 768 pixels or higher Number of display colors 24 bits (true-color) or higher

<b>OS</b>	<b>Browser</b>
Windows XP SP3 or later	Internet Explorer 8* Mozilla Firefox Google Chrome
Windows Vista SP1 or later	Internet Explorer 8*, 9 Mozilla Firefox Google Chrome
Windows 7	Internet Explorer 8*, 9, 10 Mozilla Firefox Google Chrome
Windows 8	Internet Explorer 10 Mozilla Firefox Google Chrome
Windows 8.1	Internet Explorer 11 Mozilla Firefox Google Chrome
Mac OS X v10.6-OS X Mavericks v10.9	Safari 5.1, 6, 7

\* When you use Internet Explorer 8, the web pages may not display correctly. Canon recommends that you upgrade to Internet Explorer 9 or later, or use another browser.

## Smartphone or tablet

<b>OS</b>	<b>Browser</b>	<b>Resolution</b>
iOS 5.1 or later	OS standard browser	320 x 480 (HVGA) or higher
Android 2.3.3 or later		480 x 800 (HVGA) or higher

\*Android3.x is not supported.

## Important

- On the browser you are using, enable JavaScript and cookies.
- If you use the zoom function or change the font size on your browser, the web pages may not display correctly.
- If you use the translation function of Google Chrome, the web pages may not display correctly.
- If you use a proxy server outside of your country, the service may not be able to determine the correct region.

- In an in-house network environment, the 5222 port must be released. For confirmation instructions, contact the network administrator.

# Preparations Before Using Canon Inkjet Cloud Printing Center

To use the Canon Inkjet Cloud Printing Center, you need to follow the steps described below and register the user information.



1. Check that the printer is connected to the Internet

## »» Important

- To use this function, you must connect this printer to the Internet.

2. [Remote UI startup](#)
3. Select **IJ Cloud Printing Center setup** -> **Register with this service**
4. Follow the instructions displayed in the window, and run the authentication
5. When the printer registration screen is displayed, select **Create new account**



6. Enter the **E-mail address** of the printer's owner, and then select **OK**

The registration page URL is sent to the e-mail address entered.

**Preparation**

To create an account, enter your e-mail address.

An e-mail from "noreply@mail.cs.c-ij.com" will be sent to the specified e-mail address. If you use e-mail filters, be sure to allow e-mail from this address.

An e-mail address that is already registered cannot be used.

E-mail address:

### »» Important

- There are character restrictions for the e-mail address, as shown below.
  - You can use up to 255 alphanumeric characters consisting of single-byte characters and symbols (!#\$%&'\*+/?^\_{}|~.-@).
  - Multibyte characters cannot be used.

You will get an error if the e-mail address you enter contains a character that cannot be used.
- If you registered a different e-mail address by mistake, you can cancel the registration by [starting the remote UI](#) and selecting **IJ Cloud Printing Center setup -> Delete from this service**.
- You may not be able to receive the notification if you are using a spam filter. If you have a setting to receive only the e-mails from certain domains, be sure to change the setting to allow receiving e-mails from "noreply@mail.cs.c-ij.com".  
There will be no error display even if you could not receive the e-mail because of the spam filter setting or if you entered an incorrect e-mail address.

7. When an e-mail with the subject "Information on Canon Inkjet Cloud Printing Center" is sent to the e-mail address that you entered, select the URL
8. In the **License agreement** and **Privacy statement** windows of Canon Inkjet Cloud Printing Center, read the statements, and select **Agree** if you agree

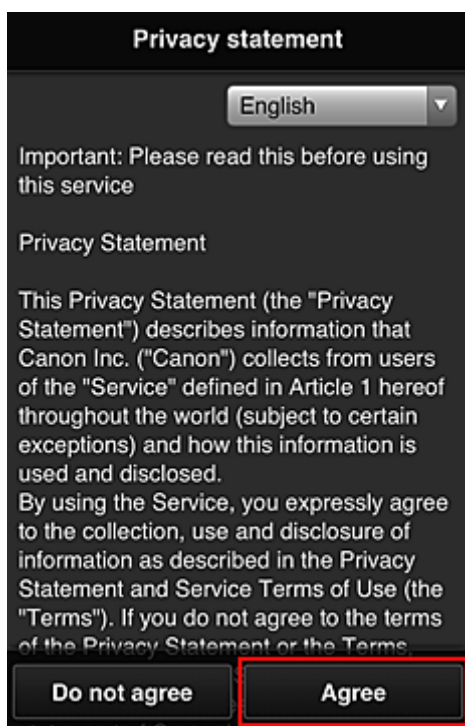
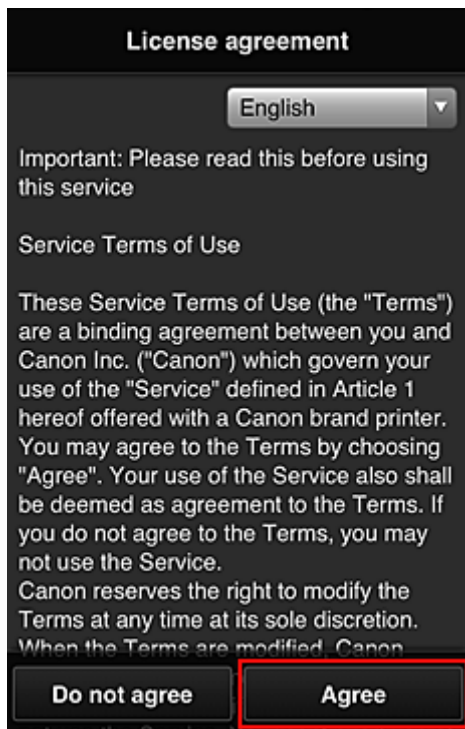

9. In the user information entry screen, enter your **Password**, and select **Next**

Enter your password for logging in to the Canon Inkjet Cloud Printing Center.

**Register user info**

Set a password for logging into this service.

Password:

Password (Confirmation):

8 to 32 characters

Cancel Next

### »»» Important

- There are character restrictions for the **Password**, as shown below.
- The password needs to be between 8 and 32 characters long, using single-byte alphanumeric characters and symbols (!"#\$%&'()\*+,-./:;<=>?@[^\_`{|}~). (Alphabets are case-sensitive)

## 10. Enter the **User name**

Enter the name that identifies the user.

**Register user info**

User Name:

1 to 20 characters

Time zone:

(UTC) Coordinated Universal Time ▾

Back Next

### »»» Important

- The **User name** entry field has the following character restrictions:
- The password needs to be between 1 and 20 characters long, using single-byte alphanumeric characters and symbols (!"#\$%&'()\*+,-./:;<=>?@[^\_`{|}~). (Alphabets are case-sensitive)



11. Specify the **Time zone** setting, and select **Next**

Select your region on the list. If you cannot find your region on the list, select the one closest to your region.

**Apply daylight saving time**

This appears only when there is a daylight saving time in the **Time zone** that you selected.  
Select whether or not to apply the daylight saving time.

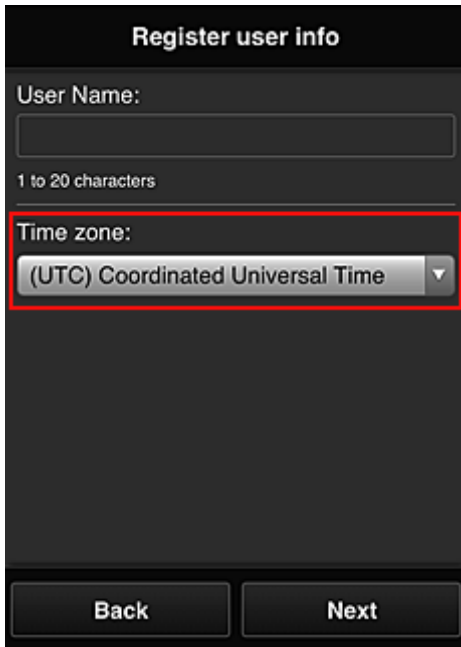

The screenshot shows a dark-themed mobile application screen titled "Register user info". At the top, there is a "User Name:" label followed by an empty text input field. Below the input field, the text "1 to 20 characters" is displayed. The "Time zone:" label is followed by a dropdown menu currently showing "(UTC) Coordinated Universal Time". A red rectangular box highlights the "Time zone:" label and the dropdown menu. At the bottom of the screen, there are two buttons: "Back" on the left and "Next" on the right.

12. Enter the **Security code** and select **Done**

Enter the code for authenticating the user.

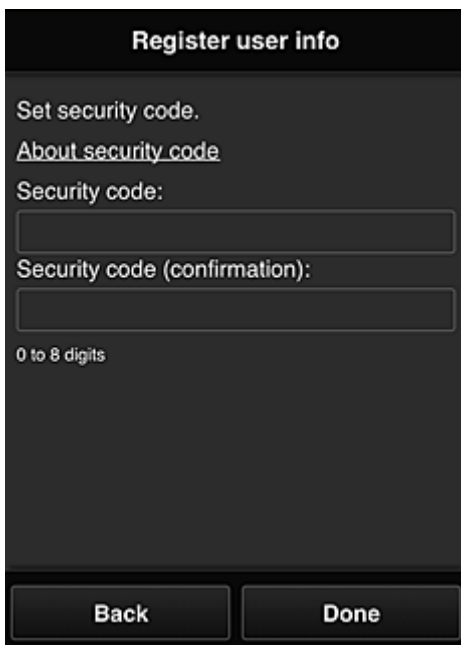

The screenshot shows a dark-themed mobile application screen titled "Register user info". The screen displays the instruction "Set security code." followed by a link "[About security code](#)". Below this, there is a "Security code:" label followed by an empty text input field. Underneath that is a "Security code (confirmation):" label followed by another empty text input field. At the bottom of the screen, there are two buttons: "Back" on the left and "Done" on the right. The text "0 to 8 digits" is visible at the bottom left of the input area.

**»»» Important**

- The **Security code** entry field has the following character restrictions:
  - Single-byte numbers

The registration is complete. A registration completion message is displayed.  
When you select the **OK** button in the message, the login screen is displayed.

Enter the registered e-mail address and password, and [log in](#) to the Canon Inkjet Cloud Printing Center.

■ [Using Canon Inkjet Cloud Printing Center](#)

# Canon Inkjet Cloud Printing Center window

This section describes the Canon Inkjet Cloud Printing Center screens that are displayed on your smartphone, tablet device, or computer.

■ [Description of the Login screen](#)

■ [Description of the Main screen](#)

## Description of the Login screen

This section provides the description of the Login screen of Canon Inkjet Cloud Printing Center.

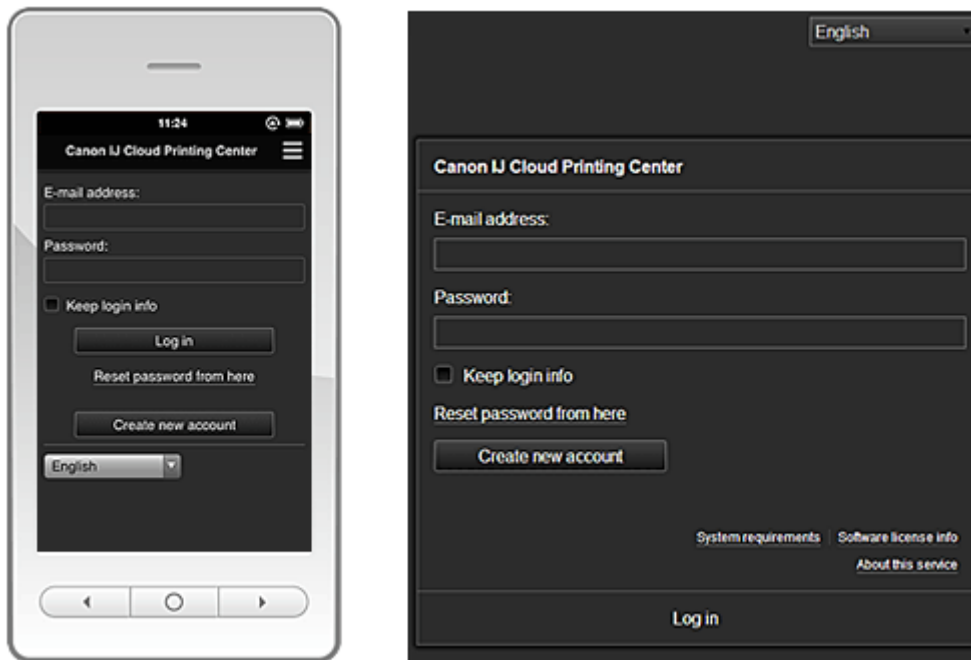

### ►► Important

- You have 5 tries to enter your password. If you fail, you will not be able to log in for about the next hour.
- You remain logged in for an hour after the last access.

### Language

Select the language you will be using.

### E-mail address

Enter the e-mail address that you entered in the user registration.

### ►► Important

- The e-mail address is case-sensitive. Make sure the case is correct.

### Password

Enter the password that you entered in the user registration.

### Keep login info

When you select the check box, the login screen is skipped for 14 days since the last day that the service screen was accessed.

### Reset password from here

Select this if you forgot the password.

Reset your password by following the instructions on the screen.

## Create new account

A new registration will be added to the Canon Inkjet Cloud Printing Center.

## System requirements

This displays the system requirements for the Canon Inkjet Cloud Printing Center.

## Help/legal notices (smartphone and tablet devices only)

The description of the Canon Inkjet Cloud Printing Center screen and various reminders are displayed.

## Software license info

The licensing information of Canon Inkjet Cloud Printing Center is displayed.

## About this service

This displays the descriptions of this service.

## Description of the Main screen

When you log in to the Canon Inkjet Cloud Printing Center, the Main screen appears.

With this service, the functions available to **Standard user** of the printer are different from those available to the printer **Administrator**.

**Standard user** can only use the functions marked by an asterisk (\*).

You can use areas shown below to start\*, add, and manage apps.

If you are using a smartphone or a tablet, you can also print photos and documents.

- [If you are using a smartphone or tablet](#)
- [If you are using a PC](#)

## If you are using a smartphone or tablet

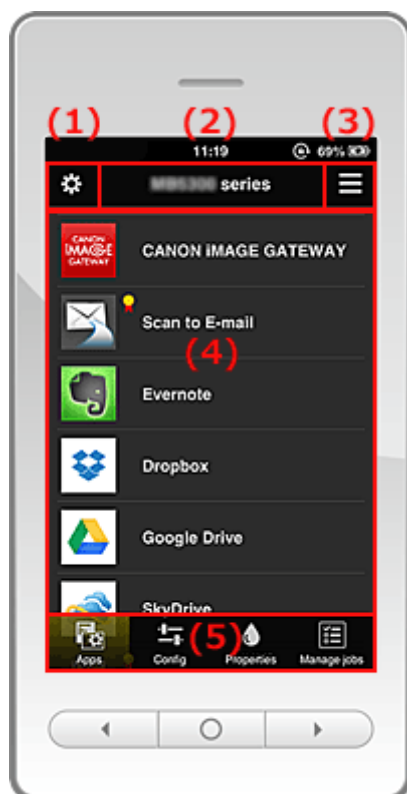

- (1) [Left context menu](#)
- (2) [Printer name area](#)

- (3) [Right context menu](#)
- (4) [Display area](#)
- (5) [Menu area](#)

**(1) Left context menu**

When you select , the **Mng. printer** screen of the **Manage users** screen appears. For general users, the **Select printer** screen appears.

**Mng. printer screen (Select printer screen)**

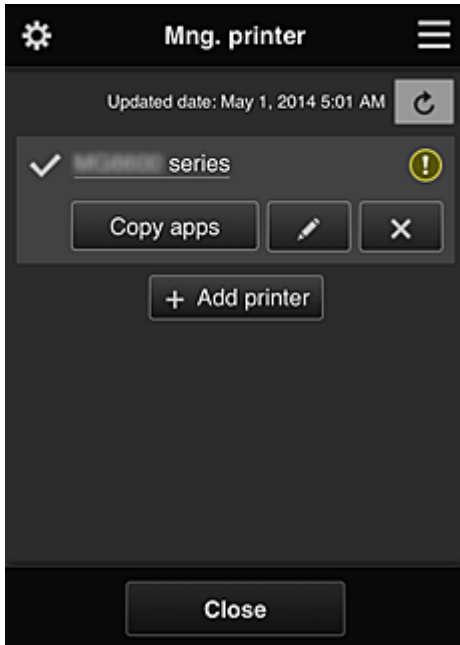

From the **Mng. printer** screen (**Select printer** screen), you can [check\\*](#) and [update\\*](#) printer information registered to the Canon Inkjet Cloud Printing Center, [change printer names](#), [delete printers](#), [add printers](#), and [copy apps](#).

• **Check the printer information\***

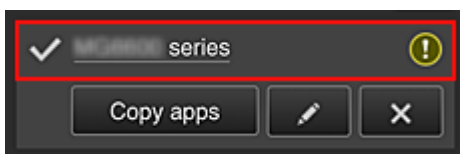

The registered printer name is displayed.

 indicates the currently selected printer.

 indicates that an error occurred on the printer.

• **Display update date/time of the printer information\***

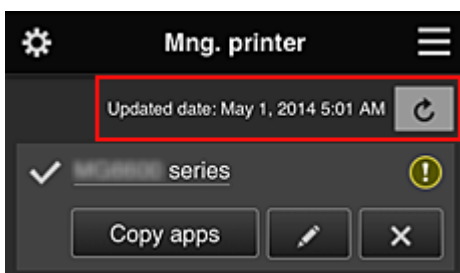

This displays the date and time the printer information was last updated.

 refreshes the information.

- **Copy apps**

Select this to copy apps added in the selected printer to another printer.

When you select , the screen shown below appears.

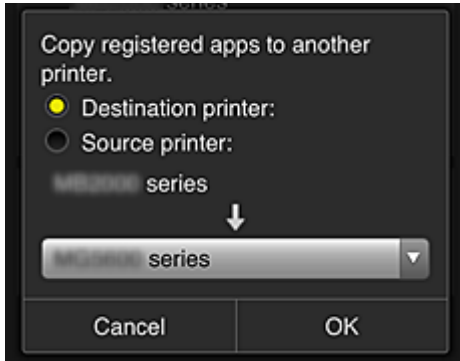

Set the **Destination printer** and the **Source printer**. Then select **OK**.

- **Change the printer name**

When you select , a screen to change the printer name appears. Follow the instructions on the screen to change the name.

▶▶▶ **Note**

- The printer name entry has the following character limitation:
  - Up to 128 characters

- **Delete printers**

When you select , the printer is deleted from the Canon Inkjet Cloud Printing Center.

When transferring the ownership of the printer, select **Clear the information saved on the printer**.

- **Add printers**

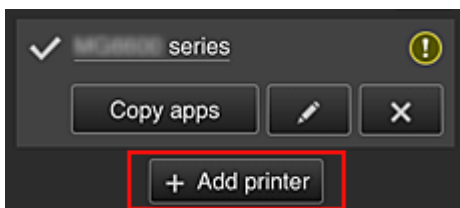

Select this to add printers to be used in the Canon Inkjet Cloud Printing Center.

▶▶▶ **Note**

- Up to 16 printers are guaranteed to operate for each e-mail address.

## Manage users screen

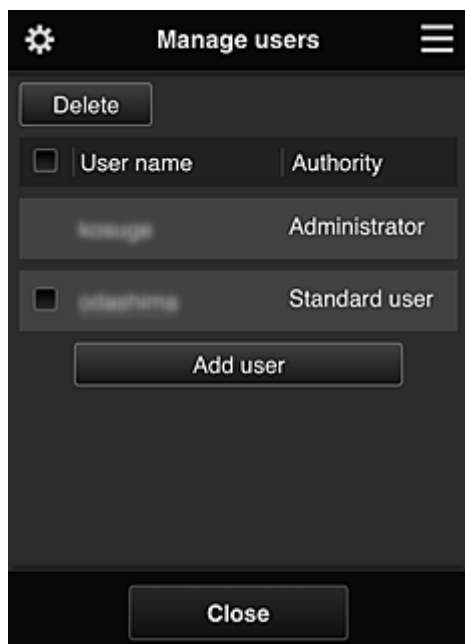

From the **Manage users** screen, you can [check user information](#) registered to the Canon Inkjet Cloud Printing Center, [delete users](#), [add users](#), and [change the Administrator and Standard user settings](#).

- **User deletion**

Select the check box of the user to be deleted, and select **Delete**.

However, you cannot delete yourself. To delete yourself, cancel your membership from the [user information](#) screen.

- **Adding a user**

Select **Add user**. The user registration screen appears.

- **Changing Administrator and Standard user settings**

You can change the privileges of the **Administrator** and **Standard users**.

## (2) Printer name area

The registered name of the printer selected is displayed.

The **Administrator** can [change the printer name](#).

## (3) Right context menu

When you select , the context menu appears.

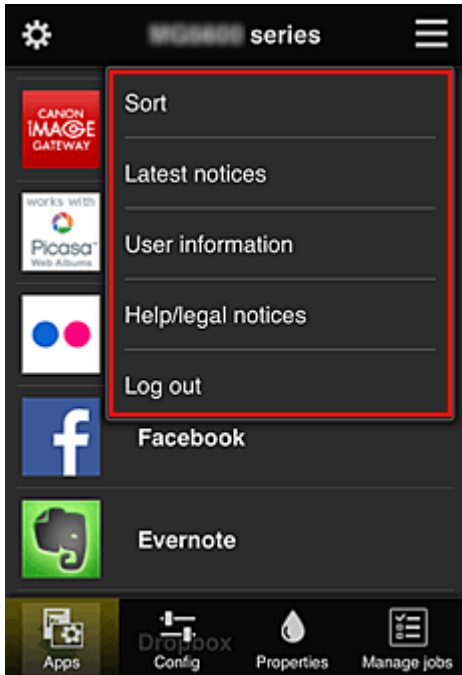

The information displayed depends on the menu currently selected in the menu area.

The  symbol indicates that there is a new unread notice.



- **Sort** **Sort**

This displays the screen to sort registered apps.

You can use the   buttons to change the display order of apps. When you finish sorting, press the **Done** button to confirm the order.

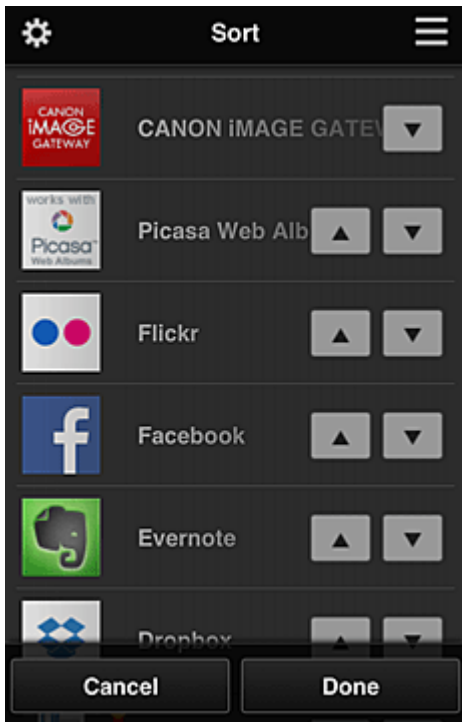

- **Latest notices** **Latest notices\***

This displays the latest notices. The  symbol indicates that there is a new unread notice.

- **User information** **User information\***

This displays the User information screen.

You can change the registered e-mail address, password, language, time zone, and other settings.



- **Help/legal notices** **Help/legal notices\***

The description of the Canon Inkjet Cloud Printing Center screen and various reminders are displayed.

- **Log out** **Log out\***

This opens the Log out screen of the Canon Inkjet Cloud Printing Center.

#### (4) Display area

The display changes based on the menu you select.

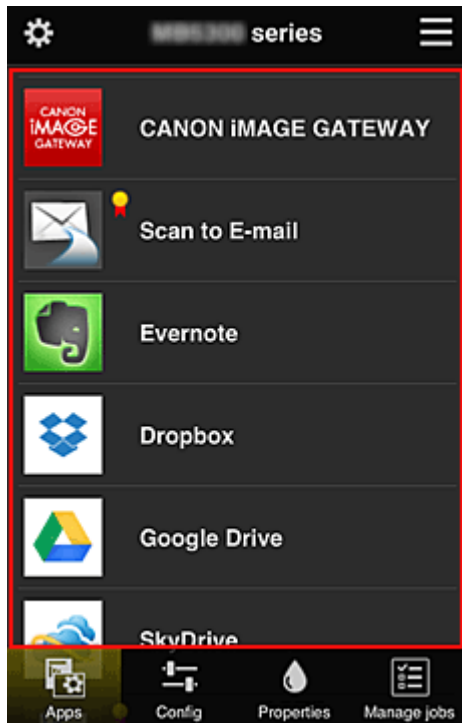

#### (5) Menu area

The following 4 menu buttons are displayed:

-  **Apps\***

This displays the list of registered apps in the [Display area](#).

-  **Config**

This displays the Register apps screen in the [Display area](#).

The display can be toggled between **Registered** and **Search apps**.

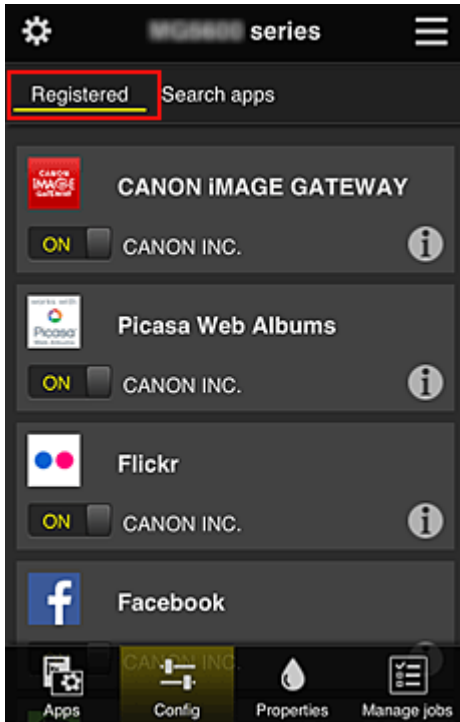

The **Registered** screen lists registered apps.

You can check the information of these apps or deregister them.

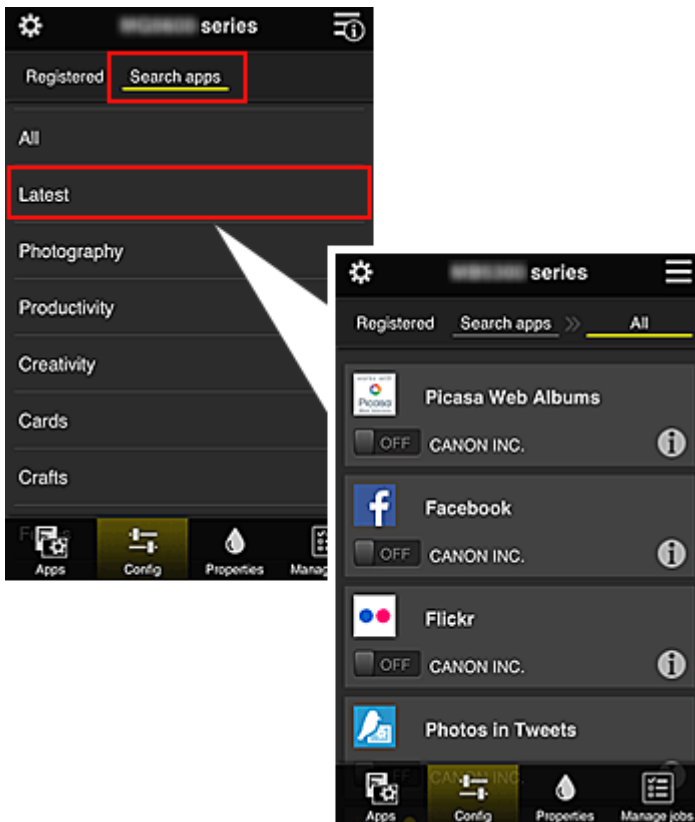

On the **Search apps** screen, the apps that you can register by using the Canon Inkjet Cloud Printing Center are displayed by category.



- When you select , the details of the app are displayed.
- When you select , you can choose to register or unregister the app.

### ▶▶▶ Note

- Description of displayed icons

 : Cannot be used because it is not yet released, not available in your region, or does

not support your model.



: Can be used with genuine Canon ink.



- **Properties\* Properties\***

This screen displays the status of the printer that is currently selected.

You can check how much ink is remaining or details about an error that occurred. You can also access the ink purchasing site and the *Online Manual*.

### »»» Important

- The Properties displayed may differ from the actual status at the display time, depending on the printer status.



- **Manage jobs\* Manage jobs\***

This screen displays the print status and the print history.

You can check the print status by looking at **Status list**, and the print history by looking at **History**.

You can also cancel print jobs and delete history information.

To cancel or delete a job, select that job and then select **Cancel** or **Delete**.

## If you are using a PC

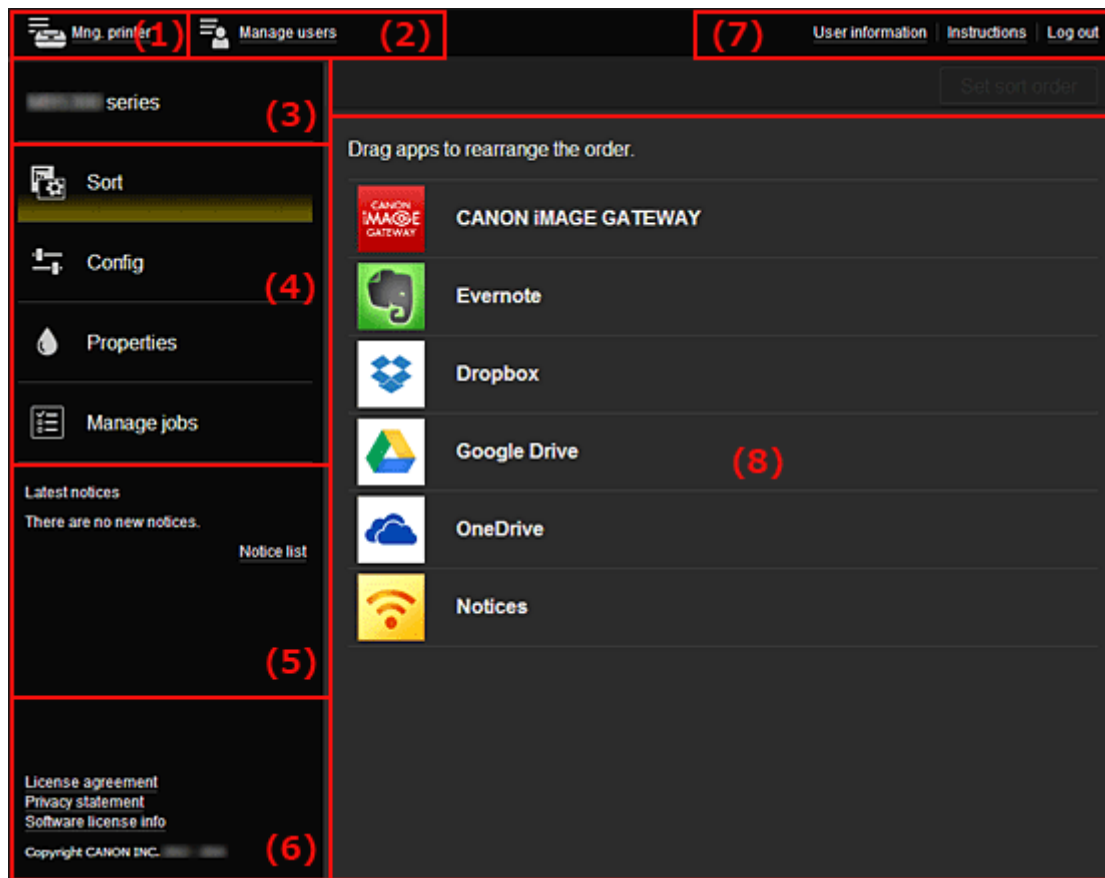

(1) [Mng. printer \(Select printer\) button](#)

(2) [Manage users button](#)

(3) [Printer name area](#)

(4) [Menu area](#)

- (5) [Notices area](#)
- (6) [Information area](#)
- (7) [Global navigation area](#)
- (8) [Display area](#)

### (1) Mng. printer (Select printer) button

When you select the **Mng. printer (Select printer)** button, the **Mng. printer (Select printer)** screen appears.

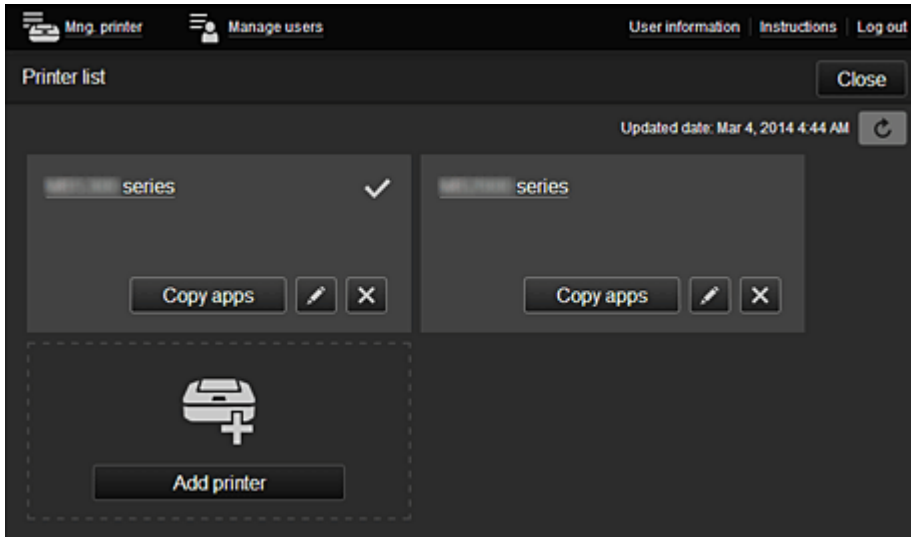

From the **Mng. printer** screen (**Select printer** screen), you can [check\\*](#) and [update\\*](#) printer information registered to the Canon Inkjet Cloud Printing Center, [change printer names](#), [delete printers](#), [add printers](#), and [copy apps](#).

- **Check the printer information\***

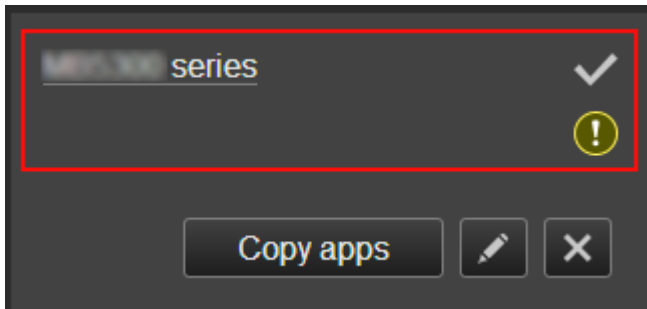

The registered printer name is displayed.

- ✓ indicates the currently selected printer.
- ⚠ indicates that an error occurred on the printer.

- **Display update date/time of the printer information\***

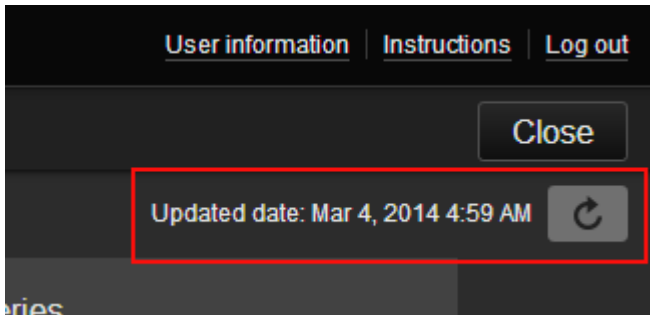

This displays the date and time the printer information was last updated.  
 refreshes the information.

- **Change the printer name**

When you select , a screen to change the printer name appears. Follow the instructions on the screen to change the name.

#### ▶▶▶ Note

- The printer name entry has the following character limitation:
  - Up to 128 characters

- **Delete printers**

When you select , the printer is deleted from the Canon Inkjet Cloud Printing Center. When transferring the ownership of the printer, select **Clear the information saved on the printer**.

- **Add printers**

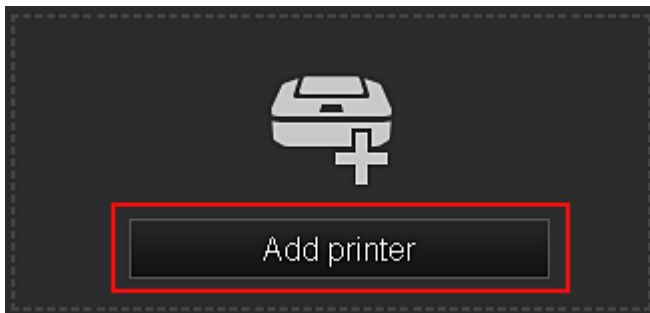

Select this to add printers to be used in the Canon Inkjet Cloud Printing Center.

#### ▶▶▶ Note

- Up to 16 printers are guaranteed to operate for each e-mail address.

- **Copy apps**

Select this to copy apps added in the selected printer to another printer.

When you select , the screen shown below appears.

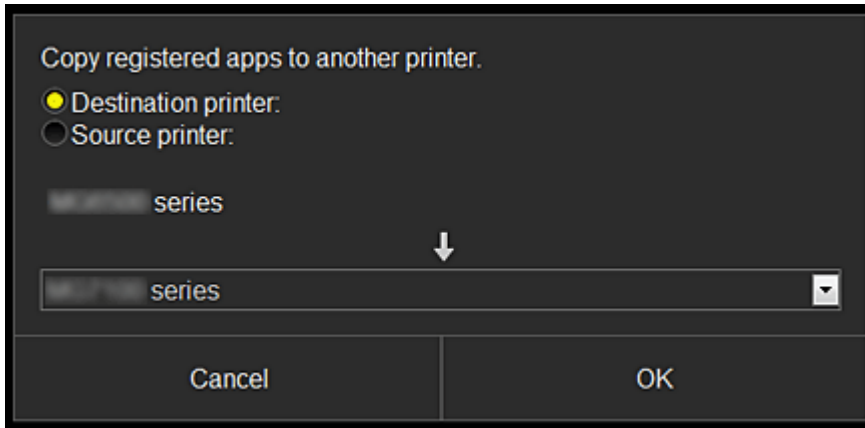

Set the **Destination printer** and the **Source printer**. Then select **OK**.

## (2) Manage users button

When you select the **Manage users** button, the Manage users screen appears.

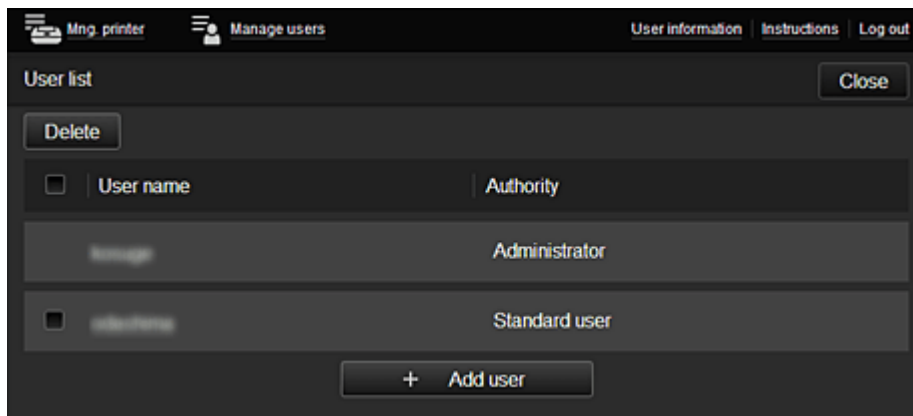

From the **Manage users** screen, you can [check user information](#) registered to the Canon Inkjet Cloud Printing Center, [delete users](#), [add users](#), and [change the Administrator and Standard user settings](#).

- **User deletion**

Select the check box of the user to be deleted, and select **Delete**.

However, you cannot delete yourself. To delete yourself, cancel your membership from the [user information](#) screen.

- **Adding a user**

Select **Add user**. The user registration screen appears.

- **Changing Administrator and Standard user settings**

You can change the privileges of the **Administrator** and **Standard users**.

## (3) Printer name area

The registered name of the printer selected is displayed.

The **Administrator** can use the **Mng. printer** functions to [change the printer name](#).

## (4) Menu area

The following 4 menu buttons are displayed:

-  **Sort (Apps)**

This displays the list of registered apps in the [Display area](#).  
Drag the app to change the order.

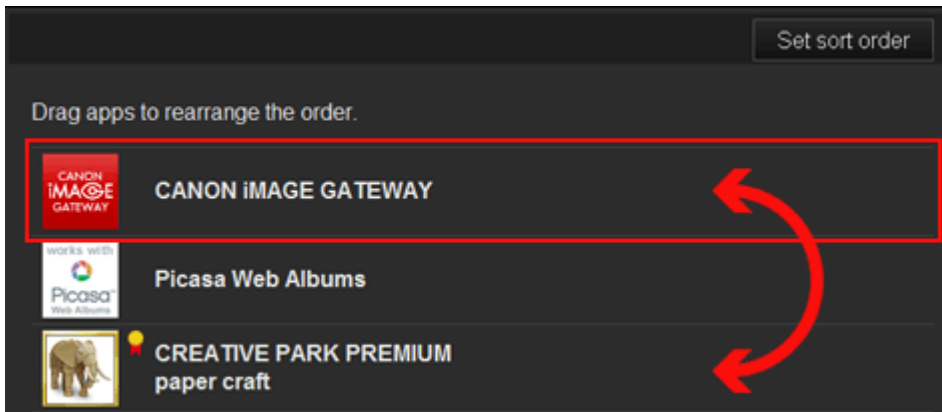

When you finish sorting, press the **Set sort order** button and confirm the order.

-  **Config**

This displays the Register apps screen in the [Display area](#).  
The display can be toggled between **Registered** and **Search apps**.

The **Registered** screen lists registered apps.  
You can check the information of these apps or deregister them.

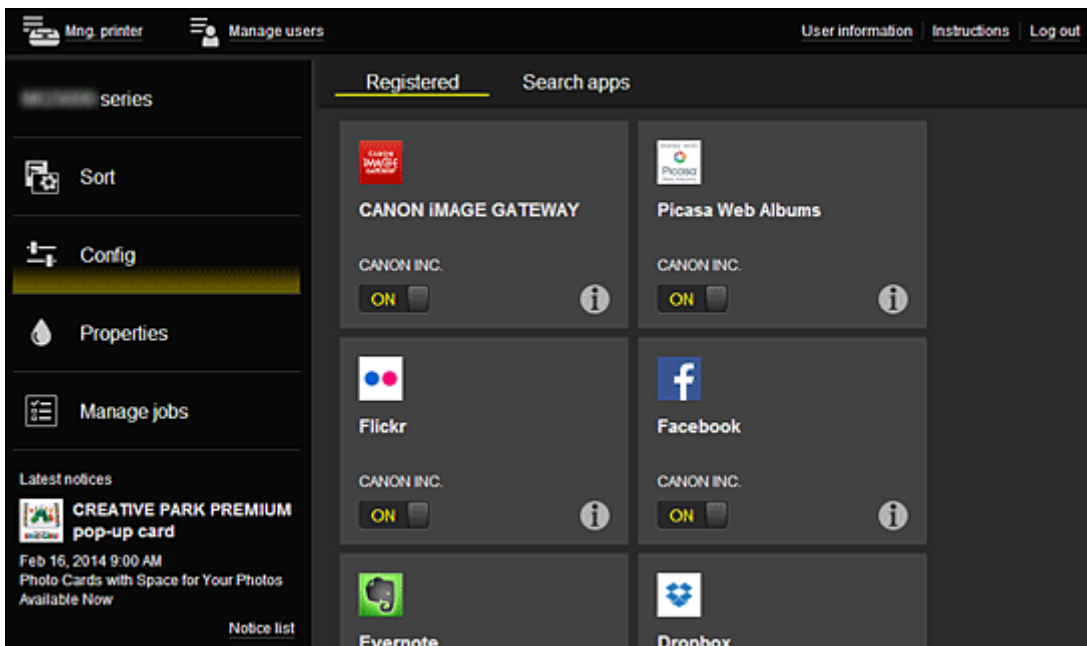

On the **Search apps** screen, the apps that you can register by using the Canon Inkjet Cloud Printing Center are displayed by category.

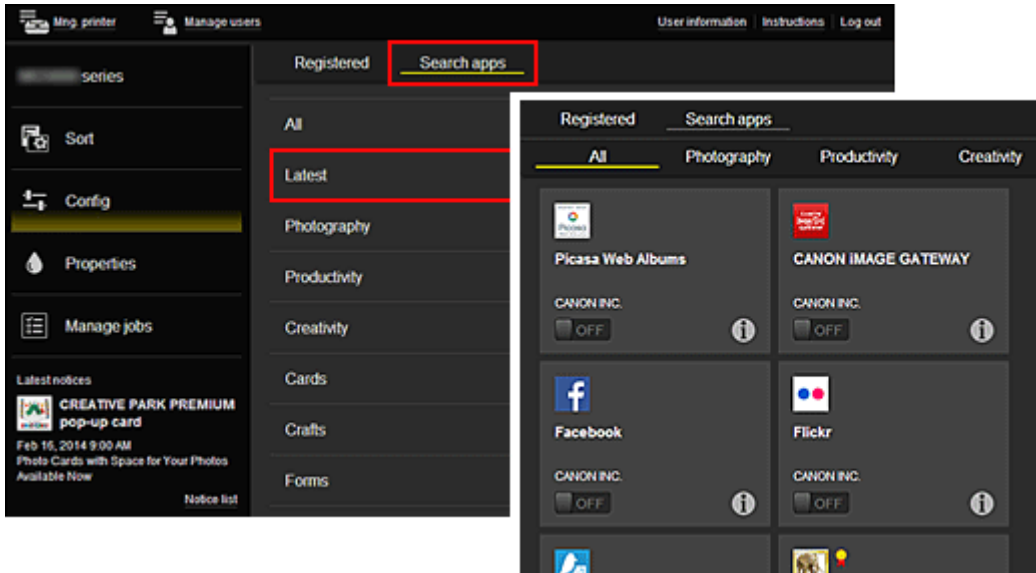

- When you select , the details of the app are displayed.
- When you select / , you can choose to register or unregister the app.

### »»» Note

- Description of displayed icons
  - : Cannot be used because it is not yet released, not available in your region, or does not support your model.
  - : Can be used with genuine Canon ink.



### • Properties\*

This screen displays the status of the printer that is currently selected. You can check how much ink is remaining or details about an error that occurred. You can also access the ink purchasing site and the *Online Manual*.

### »»» Important

- The Properties displayed may differ from the actual status at the display time, depending on the printer status.

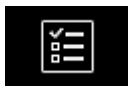

### • Manage jobs\*

This screen displays the print status and the print history. You can check the print status by looking at **Status list**, and the print history by looking at **History**. You can also cancel print jobs and delete history information. To cancel or delete a job, select that job and then select **Cancel** or **Delete**.



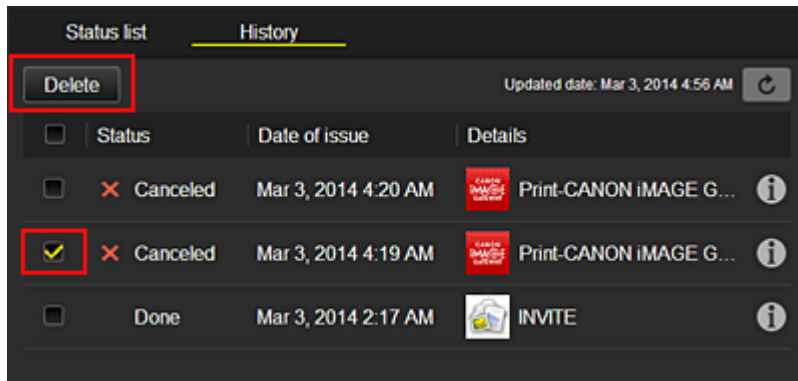

### (5) Notices area

This displays the latest notice. Nothing is displayed in this area if there is no notice. When you select **Notice list**, you can display up to 40 items.

### (6) Information area

This display other information, including the privacy statement and other companies' licensing information.

### (7) Global navigation area

The **User information\***, **Instructions\***, and **Log out\*** buttons are displayed. Press the **User information** to change the settings.

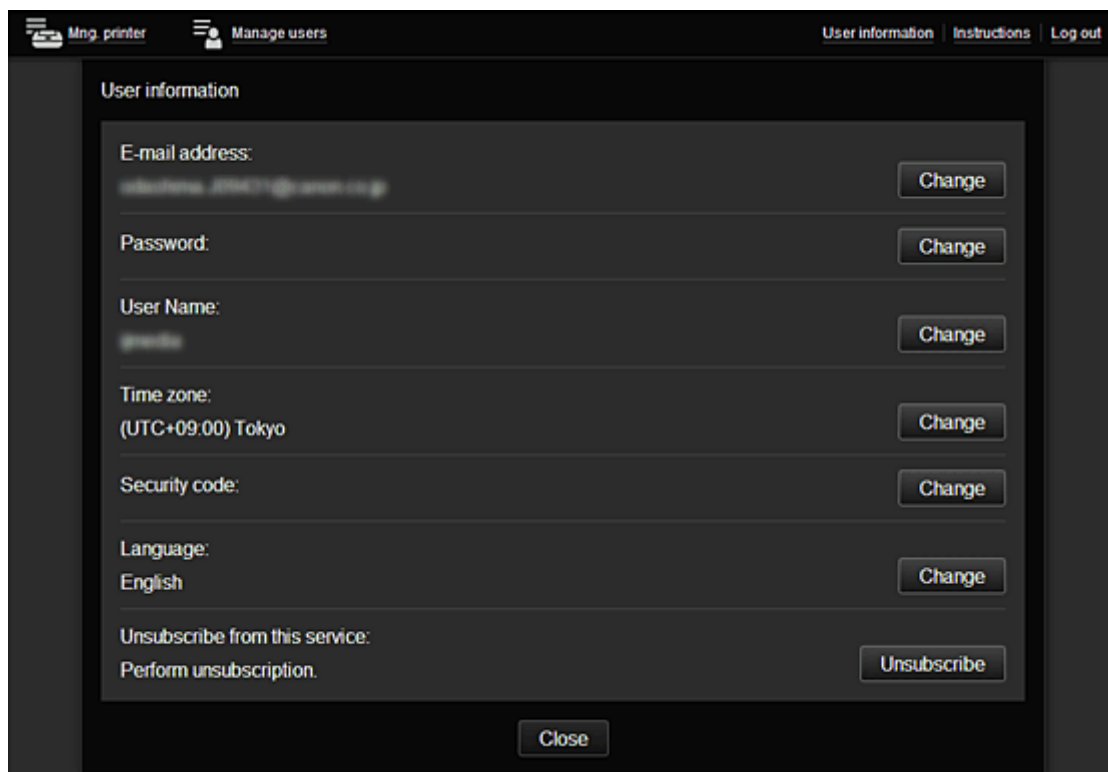

### (8) Display area

The display changes based on the menu you select.

Mng. printer    Manage users    User information    Instructions    Log out

series

Sort

Config

Properties

Manage jobs

Latest notices  
There are no new notices.  
Notice list

License agreement  
Privacy statement  
Software license info  
Copyright CANON INC.

Set sort order

Drag apps to rearrange the order.

- CANON IMAGE GATEWAY
- Evernote
- Dropbox
- Google Drive
- OneDrive
- Notices

# Using Canon Inkjet Cloud Printing Center

When the user registration is completed, you can log in to the Canon Inkjet Cloud Printing Center and use the service.

1. From your PC, smartphone, or tablet, access the service login URL (<http://cs.c-ij.com/>)
2. On the Login screen, enter the **E-mail address** and **Password**, and then select **Log in**

## ▶▶▶ Important

- The e-mail address and password are case-sensitive. Make sure the case is correct.

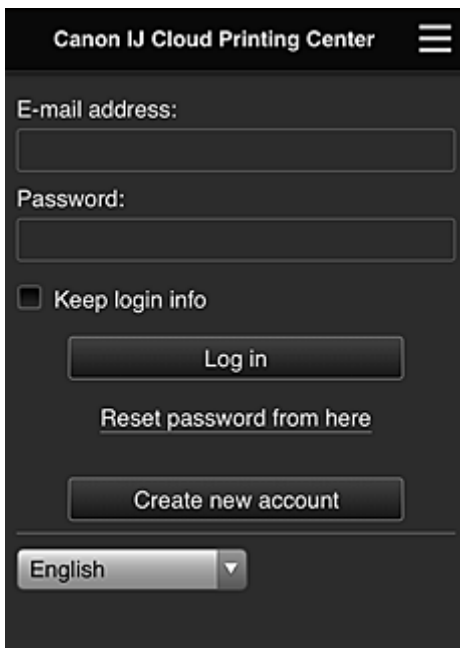

### E-mail address

Enter the e-mail address that you entered in the user registration.

### Password

Enter the password that you entered in the user registration.

### Keep login info

When you select the check box, the login screen is skipped for 14 days since the last day that the service screen was accessed.

## ▶▶▶ Important

- If you fail to log in five straight times, you will not be able to login again for an hour.
- You remain logged in for an hour after the last access.
- The service may not function properly if you log in from multiple devices at the same time.

After logging in, you can use useful services such as adding/managing apps that work in conjunction with this product's cloud functionality and checking the ink status.

For screen descriptions and operation instructions, see "[Canon Inkjet Cloud Printing Center window](#)".

## Printing procedure

This section introduces the photo printing procedure by using CANON IMAGE GATEWAY as an example.

## ▶▶▶ Important

- The available functions differ depending on the app.
- The printing procedure differs depending on the app.
- You need to get the account and register photo and other data beforehand.
- The following file formats can be printed: jpg, jpeg, pdf, docx, doc, xlsx, xls, pptx, ppt, and rtf.  
The file formats that can be printed differ depending on the app.
- Before you print, check that printer is on and is connected to the network. Then start.
- This is available if you are using a smartphone or tablet.

## ▶▶▶ Note

- You can use CANON IMAGE GATEWAY to print jpg and jpeg file formats.

1. On the Main screen, select the app to be used
2. Enter the information according to the instructions on the authentication screen, and then select **Log in**

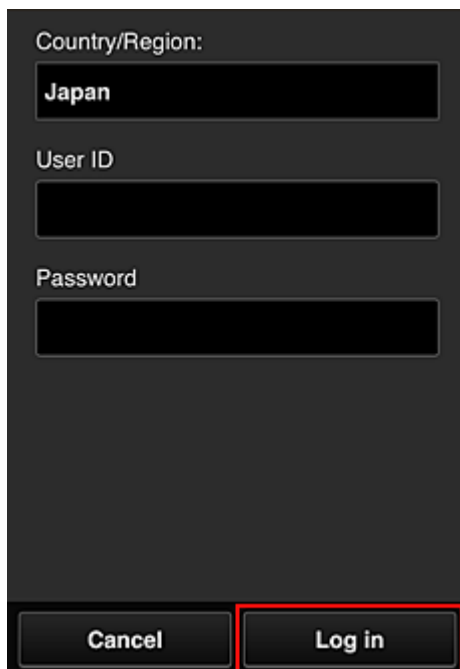

The image shows a dark-themed authentication screen. At the top, it says "Country/Region:" followed by a dropdown menu showing "Japan". Below that is a "User ID" field, which is currently empty. Underneath is a "Password" field, also empty. At the bottom of the screen, there are two buttons: "Cancel" on the left and "Log in" on the right. The "Log in" button is highlighted with a red rectangular border.

3. In the displayed album list, select the album of your choice

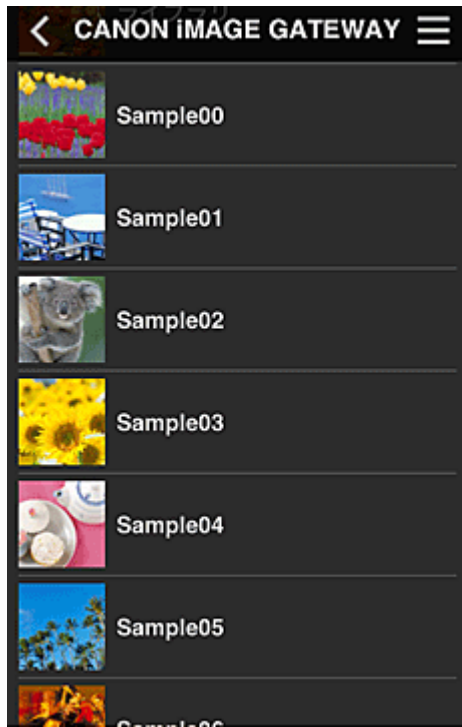

4. In the displayed image list, select the image that you want to print, and then select **Next**



5. Make the necessary print settings, and then select **Print**

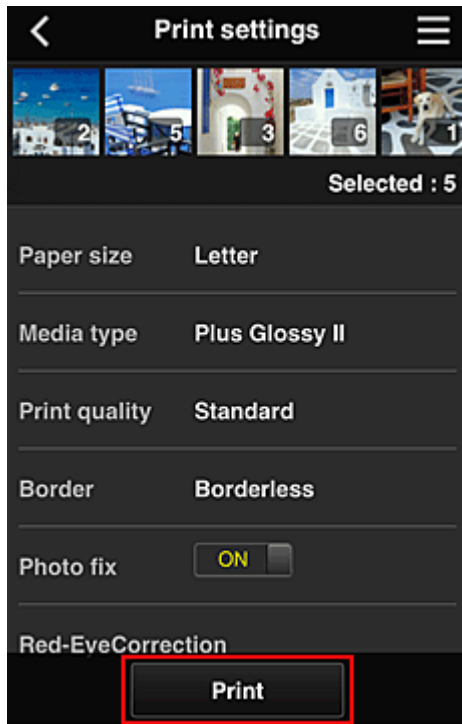

6. A print job completion message appears, and printing starts

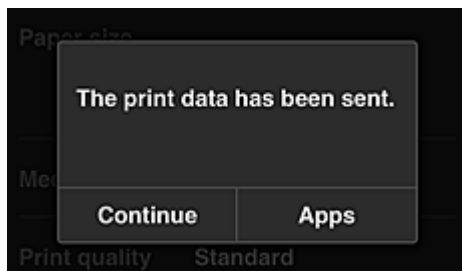

To continue printing, select **Continue**, and perform the operation from Step 3.  
To end the printing, select **Apps**. The screen returns to the apps list screen.

### »» Important

- If a print job is not printed within 24 hours after the print job is issued, the print job will expire and cannot be printed.
- With premium apps that limit the number of print jobs, print jobs that expire and cannot be printed are also included in the print count.

#### ■ [Adding a Printer](#)

## Adding a Printer

With one account, you can use the Canon Inkjet Cloud Printing Center services on multiple printers.

The procedure for adding a printer is as follows:

1. Check that the printer is connected to the Internet

### ▶▶▶ Important

- To use this function, you must connect this printer to the Internet.

2. [Remote UI startup](#)
3. Select **IJ Cloud Printing Center setup** -> **Register with this service**
4. Follow the instructions displayed in the window, and run the authentication
5. When the printer registration screen is displayed, select **Add printer**

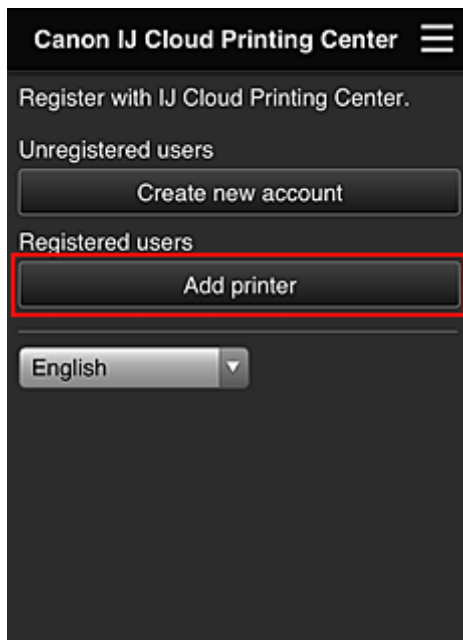

6. Enter the information according to the instructions on the authentication screen, and then select **Log in**

7. When the confirmation message is displayed, select **OK**

Printer addition is completed.

### ■ [Troubleshooting Canon Inkjet Cloud Printing Center](#)

# Troubleshooting Canon Inkjet Cloud Printing Center

- [If an app cannot be installed](#)
- [If the registered app is not in the Apps list](#)
- [If the information is not updated when you press the \*\*Update\*\* button](#)
- [If you do not receive the registration e-mail](#)
- [Printing starts on its own even if you do not do anything](#)
- [If you are unable to log in correctly even after entering the correct password in iOS or Mac](#)

## If an app cannot be installed

Check the country or region where the printer was purchased.

If you take the printer outside the country or region where you purchased it, you may not be able to install certain apps.

You can continue to use apps that are already installed, as long as the apps support the country or region you are moving to.

## If the registered app is not in the Apps list

Check the display language of Canon Inkjet Cloud Printing Center.

If the display language is switched to a language that does not support an app, the app will not be displayed in the apps list but will continue to be registered.

If you switch back to the target language of the app, it will be displayed in the apps list and you will be able to start, register, or unregister the app.

## If the information is not updated when you press the Update button

Because the Properties screen requires network connection with this product, the information may not be reflected immediately. Please wait awhile, and then try updating the information again.

If the information is still not updated, then check that the product is connected to the Internet.

## If you do not receive the registration e-mail

You may have entered a different e-mail address during the user registration of Canon Inkjet Cloud Printing Center.

[Remote UI startup](#) -> **IJ Cloud Printing Center setup** -> **Delete from this service** to delete the service registration.

After resetting the printer, repeat the user registration of Canon Inkjet Cloud Printing Center from the beginning.

## Printing starts on its own even if you do not do anything

A third party may be able to illegally use the Canon Inkjet Cloud Printing Center services.

[Remote UI startup](#) -> **IJ Cloud Printing Center setup** -> **Delete from this service** to delete the service registration.

After resetting the printer, repeat the user registration of Canon Inkjet Cloud Printing Center from the beginning.



## **If you are unable to log in correctly even after entering the correct password in iOS or Mac**

If you are using iOS or Mac, and the password contains the ¥ symbol, enter a backslash instead. For instructions on entering a backslash, see the OS help.

# Printing with Google Cloud Print

The printer is compatible with Google Cloud Print™ (Google Cloud Print is a service provided by Google Inc.).

By using Google Cloud Print, you can print from anywhere with applications or services supporting Google Cloud Print.

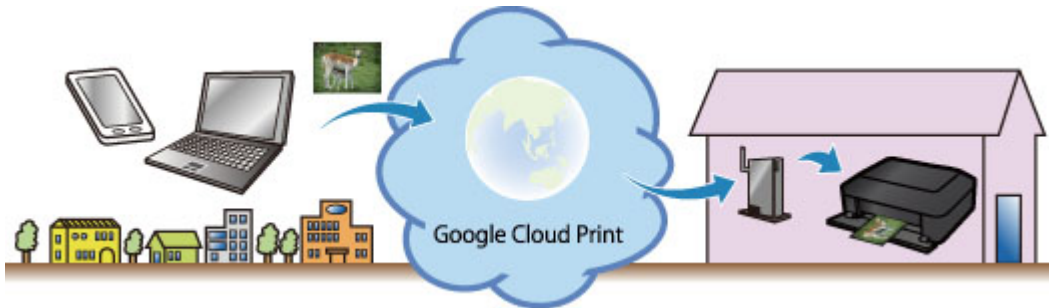

1. [Preparations for Printing with Google Cloud Print](#)
2. [Printing from Computer or Smartphone with Google Cloud Print](#)

## ▶▶▶ Important

- LAN connection with the printer and Internet connection are required to register the printer and to print with Google Cloud Print. Internet connection fees apply.
- This function may not be available depending on the country or region you live in.

# Preparations for Printing with Google Cloud Print

To print with Google Cloud Print, you need to get Google account and register the printer with Google Cloud Print in advance.

## ■ [Getting Google Account](#)

If you already have Google account, register the printer.

## ■ [Registering the Printer with Google Cloud Print](#)

### Getting Google Account

First, get your Google account in order to register the printer with Google Cloud Print.

Access to Google Cloud Print with the web browser on the computer or the mobile device, then register the required information.

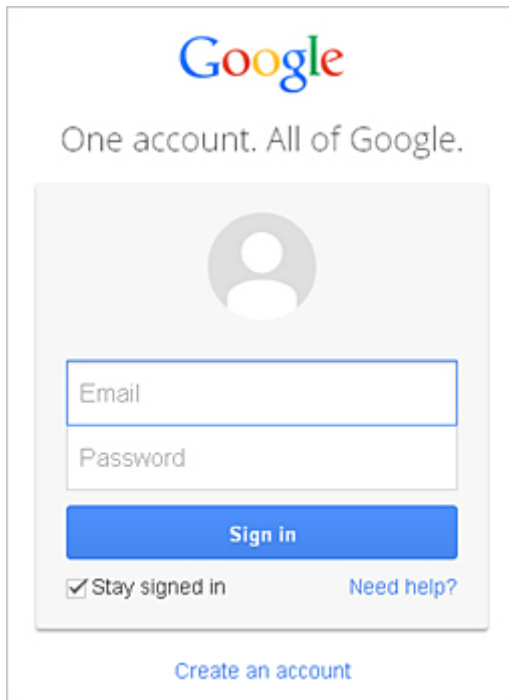

\* The screen above may change without prior notice.

### Registering the Printer with Google Cloud Print

Register the printer with Google Cloud Print.

The authentication procedure using the web browser on the computer or the mobile device is required in the process of registering.

#### ➤➤➤ Important

- LAN connection with the printer and Internet connection are required to register the printer and to print with Google Cloud Print. Internet connection fees apply.
- If the printer's owner changes, [delete the printer from Google Cloud Print](#).

1. Make sure that the printer is turned on
2. [Remote UI startup](#)

3. Select **Google Cloud Print setup -> Register with Google Cloud Print**

**»» Note**

- If you have already registered the printer with Google Cloud Print, the confirmation message to re-register the printer is displayed.

4. When the confirmation screen to register the printer is displayed, select **Yes**
5. In the print setup for Google Cloud Print, select the display language, and then select **Authentication**.
6. When the registration completion message appears, select OK.

### **Deleting the Printer from Google Cloud Print**

If the printer's owner changes or if you want to re-register the printer, delete the printer from Google Cloud Print by following the steps below.

1. Make sure that the printer is turned on
2. [Remote UI startup](#)
3. Select **Google Cloud Print setup -> Delete from Google Cloud Print**.
4. When the confirmation screen to delete the printer is displayed, select **Yes**.

# Printing from Computer or Smartphone with Google Cloud Print

When you send print data with Google Cloud Print, the printer receives the print data and prints it automatically if the printer is turned on.

When printing from a smartphone, tablet, computer, or other external device by using Google Cloud Print, load paper into the printer in advance.

1. Make sure that the printer is turned on

## ▶▶▶ Note

- If you want to send the print data from an outside location, turn on the printer in advance.

2. Send print data from your smartphone, tablet, or computer

The figure below is an example of when printing from the web browser corresponding with Google Cloud Print. The screen differs depending on the applications or services supporting Google Cloud Print.

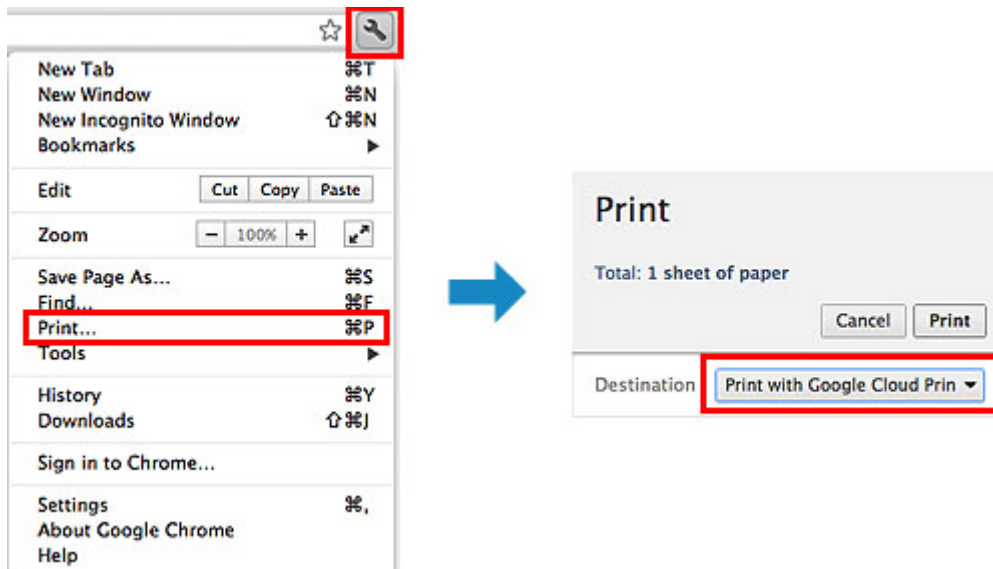

When the preparation for printing with Google Cloud Print is complete and when the printer is turned on, the printer receives the print data and prints it automatically.

## ▶▶▶ Note

- Depending on the communication status, it may take a while to print the print data or the printer may not receive the print data.
- While printing with Google Cloud Print, the printing may be canceled depending on the printer's status, such as when the printer is being operated or an error has occurred. To resume printing, check the printer's status, then print with Google Cloud Print again.
- For print settings:
  - If you select the media type other than plain paper or if you select the paper size other than A4/ Letter/B5/A5-size, the print data is printed in single-sided even when you select the duplex print setting. (\* The paper size differs depending on the model of your printer. For information about the supported paper sizes, go to the *Online Manual* home page, and refer to the "Cannot Print Properly with Automatic Duplex Printing" for your model.)
  - If you select plain paper as media type or if you select B5/A5-size as paper size, the print data is printed with border even when you select the borderless print setting.
  - The print results may differ from the print image depending on the print data.

- Depending on the device sending the print data, you may not select the print settings when sending the print data with Google Cloud Print.
-

## Printing from AirPrint Compliant Device

This document explains how to use AirPrint to print wirelessly from your iPad, iPhone and iPod touch to a Canon printer.

AirPrint enables you to print photos, email, Web pages and documents from your Apple device directly to your printer without installing a driver.



### Checking Your Environment

First, check your environment.

- **AirPrint Operation Environment**

To use AirPrint, you will need one of the following Apple devices running the latest version of iOS:

- iPad (all models)
- iPhone (3GS or later)
- iPod touch (3rd generation or later)

- **Network Environment**

The Apple device (iPad, iPhone, or iPod touch) and this printer must be connected to the same Wi-Fi network or connected in AP mode.

#### ►► Note

- If your iPad, iPhone or iPod touch is running the latest version of iOS, you do not need to download and install any drivers or additional software.

### Printing with AirPrint

1. Check that this printer is turned on and the Apple device and this printer is connected to the LAN or connected in AP mode.
2. From the app of your Apple device, tap the operation icon to display the menu options.

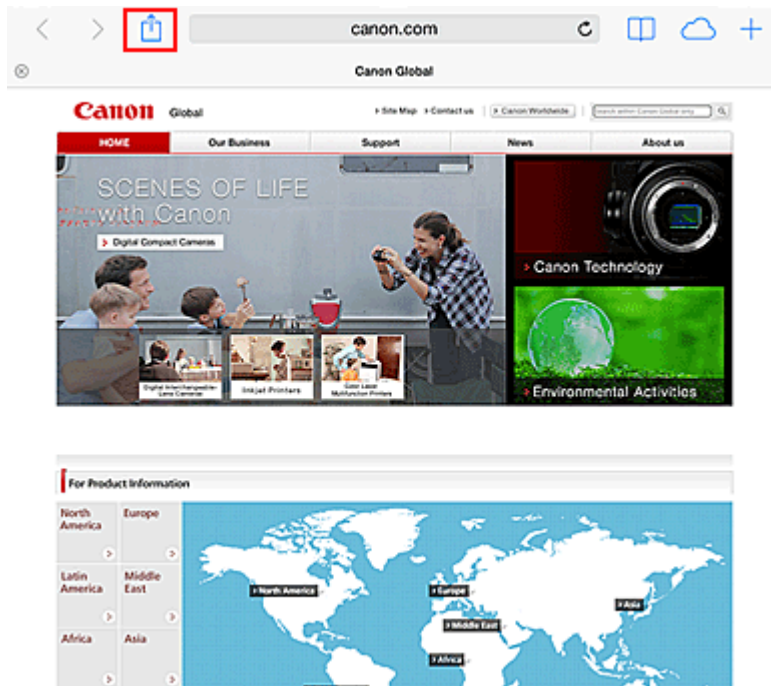

3. From the menu options, tap **Print**.

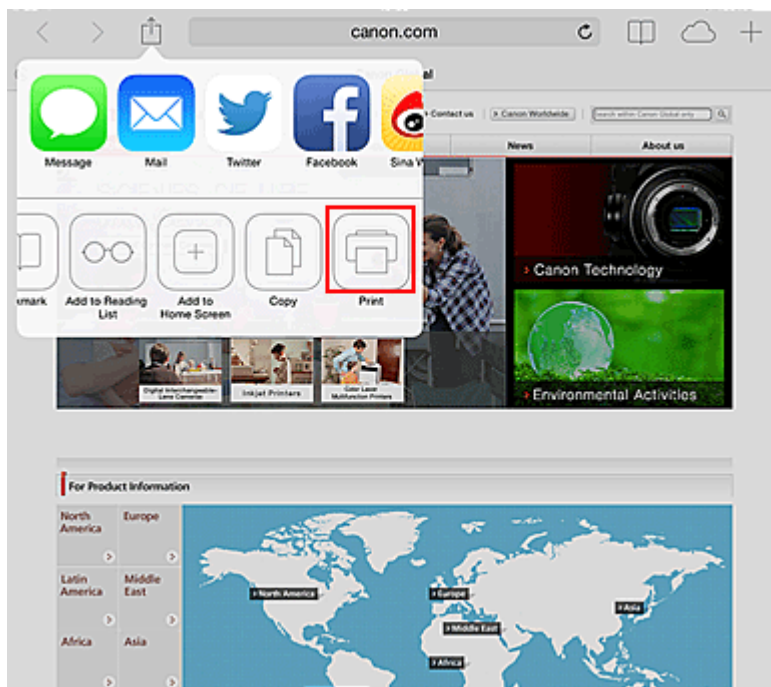

4. From **Printer Options**, select the model that you are using.

### »»» Important

- Because some app does not support AirPrint, **Printer Options** may not be displayed. If an app does not let you use printer options, you cannot print from that app.

### »»» Note

- The **Printer Options** differ depending on the app and model you are using.



5. When printing a file type that has multiple pages, such as a PDF file, click **Range** and then click **All Pages** or select the range of pages to be printed.
6. For **1 Copy**, click **+** or **-** to set the number of required copies.
7. For **Duplex Printing**, click **On** to enable duplex printing or click **Off** to disable the function.
8. Tap the **Print**.

When you execute printing, the printer prints according to the specified settings.

## Paper Size

With AirPrint, the paper size is selected automatically according to the app being used on the Apple device and the region in which AirPrint is used.

When Apple's photo app is used, the default paper size is L size in Japan, and 4"x6" or KG in other countries and regions.

When documents are printed from Apple's Safari app, the default paper size is letter size in the U.S. region, and A4 in Japan and Europe.

### ▶▶ Important

- Your app may support different paper sizes.

## Checking the Print Status

During printing, a **Print Center** icon is displayed in the list of recently used apps, and you can use it to check the print progress.

Press the Home button on the Apple device twice to set the **Multitasking** mode. Then swipe to the right to display the **Print Center** icon and a **Print Summary**.

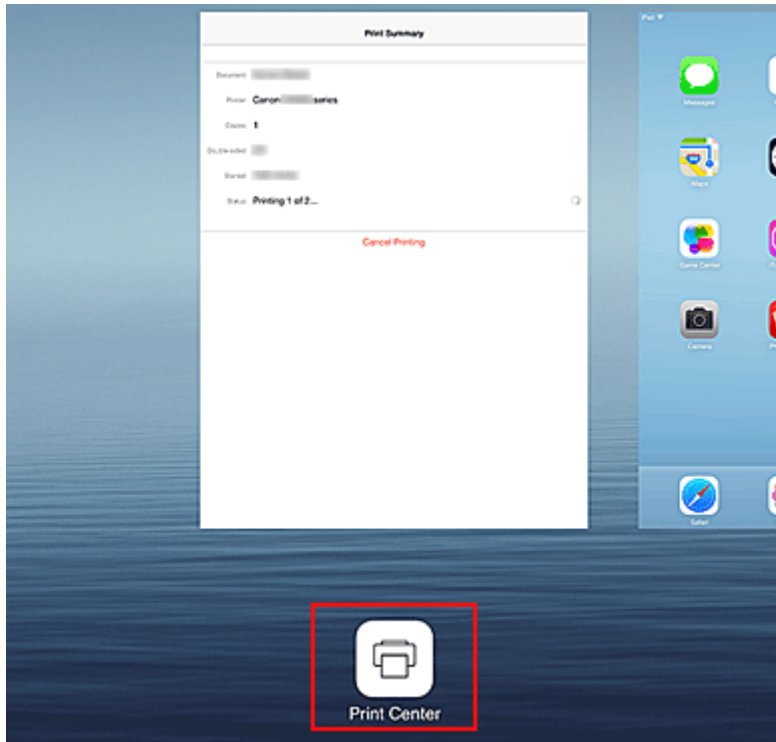

## Deleting a Print Job

To delete a print job with AirPrint, use one of the following two methods:

- From the printer: If your printer has a LCD monitor, use the operation panel to cancel the print job. If your printer does not have a LCD monitor, press the **Stop** button on the printer to cancel the print job.
- From an Apple device: Press the Home button on the Apple device twice to set the **Multitasking** mode, and then swipe to the right. Tap the **Print Center** icon to display a **Print Summary**. Tap the print job to be canceled, and then tap **Cancel Printing**.

## AirPrint Troubleshooting

If the document does not print, check the following:

1. Check that the printer power is on. If the printer power is on, turn it off and then back on again, and check whether the issue is resolved.
2. Check that the printer is connected by LAN to the same network subnet as the device on which iOS is installed.
3. Check that the printer has enough paper and ink.
4. If your printer has a LCD monitor, check that no error message is displayed on the LCD monitor.

If the problem persists, use the printer driver on your computer to execute printing and check whether the document can be printed normally on the printer.

If the document cannot be printed, refer to the *Online Manual* for your model.

**»» Note**

- After you turn on the printer, it may take few minutes before the printer can communicate through a wireless LAN connection. Confirm that the printer is connected to the wireless LAN, and then try printing.
- If Bonjour on the printer is disabled, AirPrint cannot be used. Check the LAN settings on the printer, and enable Bonjour.

**»» Note**

- The windows used in the explanations may differ from those displayed by your Apple product or app.

## **Android Print**

### **Use the Canon printing plugin**

Canon Print Service is a printing plug-in for Android 4.4 available for free on Google Play. Installing and activating the plug-in enables your Android smartphone or tablet to print wirelessly to a Canon printer.

### **Printing via Mopria**

You can print wirelessly to a Canon printer from a Mopria compatible Android smartphone or tablet.

See the Mopria homepage (<http://www.mopria.org>) for details including supported devices.

# Checking Printer Information

You can use your smartphone, tablet, or computer to check the **Printer status** and execute utility functions from apps such as Canon Inkjet Print Utility and PIXMA Printing Solutions.

You can also use the convenient web services presented by Canon.

## 1. Selecting Printer Information in an Apps Screen

### ▶▶▶ Note

- You can also enter IPv4 address directly in the web browser to display printer information.
  1. Check that the printer has been turned on
  2. Load one sheet of A4 size or Letter size plain paper
  3. Hold down the **RESUME** button until the **POWER** lamp flashes 6 times
  4. Release the button  
Printing of the network setup information starts.
  5. From your computer, smartphone, or tablet device, open the Web browser, and enter the following URL:  
`http:// <Printer IP address>`  
For <Printer IP address>, enter the IP address that you checked in the previous procedure.

## 2. Entering **Username** and Administrator's Password

From the authentication screen, enter the **Username** and **Password**.

**Username:** ADMIN

**Password:** See "[About the Administrator Password.](#)"

### ▶▶▶ Note

- The **Username** display may differ depending on your browser.

## 3. Displaying Printer Information

The top screen for printer information is displayed.

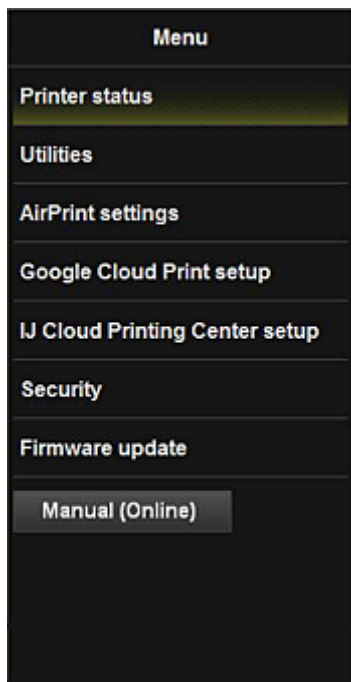

### Printer status

This function displays printer information such as the remaining ink amount, the status, and detailed error information.

You can also connect to the ink purchase site or support page, and use Web Services.

### Utilities

This function allows you to set and execute the printer utility functions such as cleaning.

### AirPrint settings

This function allows you to specify the Apple AirPrint settings, such as position information.

### Google Cloud Print setup

This function allows you to register this printer to Google Cloud Print or delete the printer.

### IJ Cloud Printing Center setup

Allows you to register to IJ Cloud Printing Center or to delete a registration.

### Security

Allows you to set the **Administrator's** password and **Operation restrictions** for the machine.

#### ▶▶▶ Important

- For the initial **Password**, see "[About the Administrator Password.](#)"  
For Security reasons, we recommend that you change the **Password** to an individual password.
- The following character restrictions apply to the password that you enter:
  - Set the password by using 0 to 32 characters.
  - The allowed characters are single-byte alphanumeric characters.

### Firmware update

This function allows you to update the firmware and check version information.

### Manual (Online)

This function displays the *Online Manual*.

## Print Easily from a Smartphone or Tablet with PIXMA Printing Solutions

Use PIXMA Printing Solutions to easily print photos saved on a smartphone or tablet wirelessly.

PIXMA Printing Solutions can be downloaded from App Store and Google Play.



## Printing with Windows RT

When you use Windows RT, printing is easy because you simply connect this printer to the network.

For information about connecting to the network, see the setup URL (<http://www.canon.com/ijsetup>) for using this product from your computer, smartphone, or tablet device.

When the connection is complete, the Canon Inkjet Print Utility software, which allows you to specify detailed print settings, is downloaded automatically.

By using Canon Inkjet Print Utility, you can check the **Printer status** and specify detailed print settings. (The available functions will differ depending on your usage environment and connection method.)



# Overview of the Printer

- ▶ **Safety Guide**
  - Safety Precautions
  - Regulatory and Safety Information
- ▶ **Main Components and Basic Operations**
  - Main Components
  - About the Power Supply of the Printer
- ▶ **Loading Paper**
  - Loading Paper
- ▶ **Replacing an Ink Tank**
  - Replacing an Ink Tank
  - Checking the Ink Status from Your Computer
  - Checking the Ink Status
- ▶ **Maintenance**
  - When Printing Becomes Faint or Colors Are Incorrect
  - Performing Maintenance from a Computer
  - Cleaning the Printer
- ▶ **Changing the Printer Settings**
  - Changing Printer Settings from Your Computer
  - Changing the Machine Settings Using the Operation Panel
  - Initializing the Printer Settings
  - Disabling the Wireless LAN Function of the Printer
  - Setting the Ink Usage Control
- ▶ **Information about Network Connection**
  - Useful Information about Network Connection
- ▶ **About Network Communication**
  - Changing and Confirming Network Settings
  - Appendix for Network Communication
- ▶ **Tips for Ensuring Optimal Printing Quality**
  - Useful Information about Ink
  - Key Points to Successful Printing
  - Be Sure to Make Paper Settings after Loading Paper
  - Canceling a Print Job
  - Printer Handling Precautions
  - Key to Enjoying Consistent Printing Quality
  - Precautions for Safe Transport of the Printer
- ▶ **Legal Limitations on Use of Your Product and Use of Images**
- ▶ **Carrying the Printer**
- ▶ **Traveling Abroad with the Printer**
- ▶ **Accessories**
- ▶ **Specifications**

## **Safety Guide**

- ▶ **Safety Precautions**
- ▶ **Regulatory and Safety Information**

# Safety Precautions

## Choosing a location

- Do not install the machine in a location that is unstable or subject to excessive vibration.
- Do not install the machine in locations that are very humid or dusty, in direct sunlight, outdoors, or close to a heating source.  
To avoid the risk of fire or electric shocks, use the machine under the operating environment specified in the On-screen Manual.
- Do not place the machine on a thick rug or carpet.

## Power supply

- Ensure that the area around the power outlet is kept clear at all times so you can easily unplug the power cord if necessary.
- Never remove the plug by pulling on the cord.  
Pulling the cord may damage the power cord, leading to possible fire or electrical shock.
- Do not use an extension lead/cord.

## Working around the machine

- Never put your hands or fingers in the machine while it is printing.
- When moving the machine, carry the machine at both ends. In case the machine weighs more than 14 kg, it is recommended to have two people lifting the machine. Accidental dropping of the machine causes injury. For the machine's weight, refer to the On-screen Manual.
- Do not carry or store the printer with the front of printer (the Paper Output Slot Cover side) down. A failure can result.
- Do not place any object on the machine. Especially do not place metal objects (paper clips, staples, etc.) or containers of flammable solvents (alcohol, thinners, etc.) on top of the machine.

## Working around the machine (For the multifunction printer)

- When loading a thick book on the Platen Glass, do not press hard on the Document Cover. The Platen Glass may break and cause injury.

## Print Heads/ink tanks and FINE Cartridges

- Keep ink tanks out of the reach of children. In case ink\* is accidentally licked or swallowed, rinse out mouth or give one or two glasses of water to drink. If irritation or discomfort occurs, obtain medical advice immediately.  
\* Clear Ink contains nitrate salts (For models containing Clear Ink).
- In case ink gets in contact with eyes, rinse with water immediately. In case ink gets in contact with skin, wash with soap and water immediately. If irritation to eyes or skin persists, obtain medical advice immediately.
- Never touch the electrical contacts on a Print Head or FINE Cartridges after printing.  
The metal parts may be very hot and could cause burns.
- Do not throw ink tanks and FINE Cartridges into fire.
- Do not attempt to disassemble or modify the Print Head, ink tanks, and FINE Cartridges.

## **Universal AC Adapter**

- When you pack the universal AC adapter for travel or storage, never wrap the cord around the body of the AC adapter to prevent the cord from splitting or separating from the body of the AC adapter and causing a short circuit.

# Regulatory and Safety Information

## For models containing lithium battery

- Dispose of used batteries according to the local regulations.
- Risk of explosion if battery is replaced by an incorrect type.

## Users in the U.S.A.

FCC Notice (U.S.A. Only)

For 120V, 60Hz model

Model Number: K10404 (Contains FCC ID: AZDK30357)

This device complies with Part 15 of the FCC Rules. Operation is subject to the following two conditions: (1) This device may not cause harmful interference, and (2) this device must accept any interference received, including interference that may cause undesired operation.

Note: This equipment has been tested and found to comply with the limits for a Class B digital device, pursuant to Part 15 of the FCC Rules. These limits are designed to provide reasonable protection against harmful interference in a residential installation. This equipment generates, uses and can radiate radio frequency energy and, if not installed and used in accordance with the instructions, may cause harmful interference to radio communications.

However, there is no guarantee that interference will not occur in a particular installation. If this equipment does cause harmful interference to radio or television reception, which can be determined by turning the equipment off and on, the user is encouraged to try to correct the interference by one or more of the following measures:

- Reorient or relocate the receiving antenna.
- Increase the separation between the equipment and receiver.
- Connect the equipment into an outlet on a circuit different from that to which the receiver is connected.
- Consult the dealer or an experienced radio/TV technician for help.

Use of a shielded cable is required to comply with Class B limits in Subpart B of Part 15 of the FCC Rules.

Do not make any changes or modifications to the equipment unless otherwise specified in the manual. If such changes or modifications should be made, you could be required to stop operation of the equipment.

FCC ID:AZDK30357

Changes or modifications not expressly approved by the party responsible for compliance could void the user's authority to operate equipment.

This transmitter must not be co-located or operating in conjunction with any other antenna or transmitter.

The equipment complies with FCC radiation exposure limits for uncontrolled equipment. This equipment should be installed and operated with minimum distance at least 20cm between the radiator and persons body (excluding extremities: hands, wrists, feet and ankles) and must not be colocated or operated with any other antenna or transmitter.

Canon U.S.A., Inc.

One Canon Park

Melville, New York 11747

1-800-652-2666

## Users in Canada

This device complies with Industry Canada license-exempt RSS standard(s). Operation is subject to the following two conditions:

(1) this device may not cause interference, and (2) this device must accept any interference, including interference that may cause undesired operation of the device.

This equipment complies with IC radiation exposure limits set forth for an uncontrolled environment and meets RSS-102 of the IC radio frequency (RF) Exposure rules. This equipment should be installed and operated keeping the radiator at least 20cm or more away from person's body (excluding extremities: hands, wrists, feet and ankles).

## Pour les usagers résidant au Canada

Le présent appareil est conforme aux CNR d'Industrie Canada applicables aux appareils radio exempts de licence. L'exploitation est autorisée aux deux conditions suivantes :

(1) l'appareil ne doit pas produire de brouillage, et (2) l'utilisateur de l'appareil doit accepter tout brouillage radioélectrique subi, même si le brouillage est susceptible d'en compromettre le fonctionnement.

Cet équipement est conforme aux limites d'exposition aux rayonnements énoncées pour un environnement non contrôlé et respecte les règles d'exposition aux fréquences radioélectriques (RF) CNR-102 de l'IC. Cet équipement doit être installé et utilisé en gardant une distance de 20 cm ou plus entre le dispositif rayonnant et le corps (à l'exception des extrémités : mains, poignets, pieds et chevilles).

## Users in Jordan

This printer contains WLAN Module approved by TRC/LPD/2013/130

Name of WLAN Module : K30357

## Only for European Union and EEA (Norway, Iceland and Liechtenstein)



These symbols indicate that this product is not to be disposed of with your household waste, according to the WEEE Directive (2012/19/EU), the Battery Directive (2006/66/EC) and/or national legislation implementing those Directives. If a chemical symbol is printed beneath the symbol shown above, in accordance with the Battery Directive, this indicates that a heavy metal (Hg = Mercury, Cd = Cadmium, Pb = Lead) is present in this battery or accumulator at a concentration above an applicable threshold specified in the Battery Directive. This product should be handed over to a designated collection point, e.g., on an authorized one-for-one basis when you buy a new similar product or to an authorized collection site for recycling waste electrical and electronic equipment (EEE) and batteries and accumulators. Improper handling of this type of waste could have a possible impact on the environment and human health due to potentially hazardous substances that are generally associated with EEE. Your cooperation in the correct disposal of this product will contribute to the effective usage of natural resources. For more information about the recycling of this product, please contact your local city office, waste authority, approved scheme or your household waste disposal service or visit [www.canon-europe.com/weee](http://www.canon-europe.com/weee), or [www.canon-europe.com/battery](http://www.canon-europe.com/battery).

## Korisnici u Srbiji

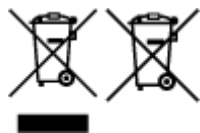

Ovaj simbol označava da ovaj proizvod ne sme da se odlaže sa ostalim kućnim otpadom, u skladu sa WEEE Direktivom (2012/19/EU), Direktivom o baterijama (2006/66/EC) i nacionalnim zakonima. Ukoliko je ispod gore navedenog simbola odštampan hemijski simbol, u skladu sa Direktivom o baterijama, ovaj simbol označava da su u ovoj bateriji ili akumulatoru prisutni teški metali (Hg – živa, Cd – kadmijum, Pb - olovo) u koncentracijama koje premašuju prihvatljivi prag naveden u Direktivi o baterijama. Ovaj proizvod treba predati određenom centru za prikupljanje, npr. po principu „jedan-za-jedan“ kada kupujete sličan novi proizvod, ili ovlašćenom centru za prikupljanje za reciklažu istrošene električne i elektronske opreme (EEE), baterija i akumulatora. Nepravilno rukovanje ovom vrstom otpada može imati negativne posledice po životnu sredinu i ljudsko zdravlje usled potencijalno opasnih materijala koji se uglavnom vezuju za EEE. Vaša saradnja na ispravnom odlaganju ovog proizvoda će doprineti efikasnom korišćenju prirodnih resursa. Više informacija o tome kako možete da reciklirate ovaj proizvod potražite od lokalnih gradskih vlasti, komunalne službe, odobrenog plana reciklaže ili servisa za odlaganje kućnog otpada, ili posetite stranicu [www.canon-europe.com/weee](http://www.canon-europe.com/weee), ili [www.canon-europe.com/battery](http://www.canon-europe.com/battery).

## India only.



This product is not to be disposed of with your household waste, according to the e-waste (Management and Handling) Rules, 2011.

This product should be handed over to a designated collection point, e.g., to an authorized collection site for recycling waste electrical and electronic equipment (EEE). Improper handling of this type of waste could have a possible negative impact on the environment and human health due to potentially hazardous substances that are generally associated with EEE. At the same time, your cooperation in the correct disposal of this product will contribute to the effective usage of natural resources. For more information regarding return and recycling of WEEE products, please visit <http://www.canon.co.in/environment/>.

Also, this product complies with the "India E-waste Rule 2011" and prohibits use of lead, mercury, hexavalent chromium, polybrominated biphenyls or polybrominated diphenyl ethers in concentrations exceeding 0.1 % by weight and 0.01 % by weight for Cadmium, except for the exemptions set in Schedule II of the Rule.

## Environmental Information

Reducing your environmental impact while saving money

### Power Consumption and Activation Time

The amount of electricity a device consumes depends on the way the device is used. This product is designed and set in a way to allow you to reduce your electricity costs. After the last print it switches to Ready Mode. In this mode it can print again immediately if required. If the product is not used for a time, the device switches to its Power Save Mode. The devices consume less power (Watt) in these modes. If you wish to set a longer Activation Time or would like to completely deactivate the Power Save Mode, please consider that this device may then only switch to a lower energy level after a longer period of

time or not at all.

Canon does not recommend extending the Activation Times from the optimum ones set as default.

## **Energy Star®**

The Energy Star® programme is a voluntary scheme to promote the development and purchase of energy efficient models, which help to minimise environmental impact.

Products which meet the stringent requirements of the Energy Star® programme for both environmental benefits and the amount of energy consumption will carry the Energy Star® logo accordingly.

## **Paper types**

This product can be used to print on both recycled and virgin paper (certified to an environmental stewardship scheme), which complies with EN12281 or a similar quality standard. In addition it can support printing on media down to a weight of 64g/m<sup>2</sup>, lighter paper means less resources used and a lower environmental footprint for your printing needs.

Regulatory Model Code (RMC) is for identification and proof that the product complies with the regulations. Please note that RMC is different from the marketing model number of the product.





## **Main Components and Basic Operations**

- **Main Components**
- **About the Power Supply of the Printer**

## **Main Components**

- ▶ **Front View**
- ▶ **Rear View**
- ▶ **Side View**
- ▶ **Inside View**

## Front View

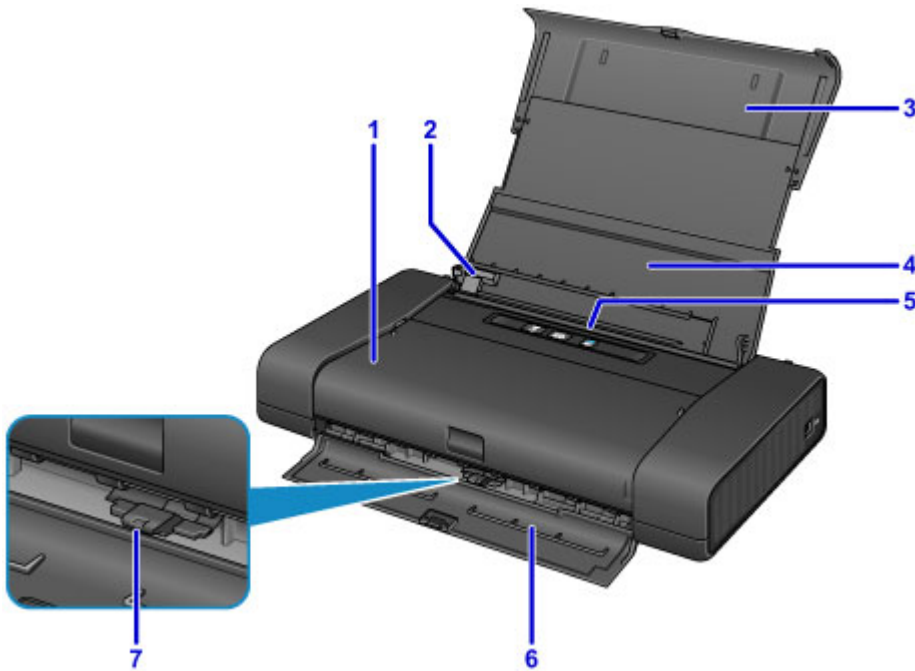

**(1) print head cover**

Open to replace an ink tank or remove jammed paper inside the printer.

**(2) paper guide**

Align with the left side of the paper stack.

**(3) paper support**

Pull out fully to support paper loaded on the rear tray.

**(4) rear tray cover**

Open to load paper in the rear tray.

**(5) rear tray**

Load paper here. Two or more sheets of the same size and type of paper can be loaded at the same time, and fed automatically one sheet at a time.

■ [Loading Plain Paper / Photo Paper](#)

■ [Loading Envelopes](#)

**(6) paper output slot cover**

Printed paper is ejected.

**(7) paper thickness lever**

Switches the clearance between the print head and the loaded paper to match the media type.

Set to the left when printing on envelopes.

Set to the right when printing on paper other than envelopes.

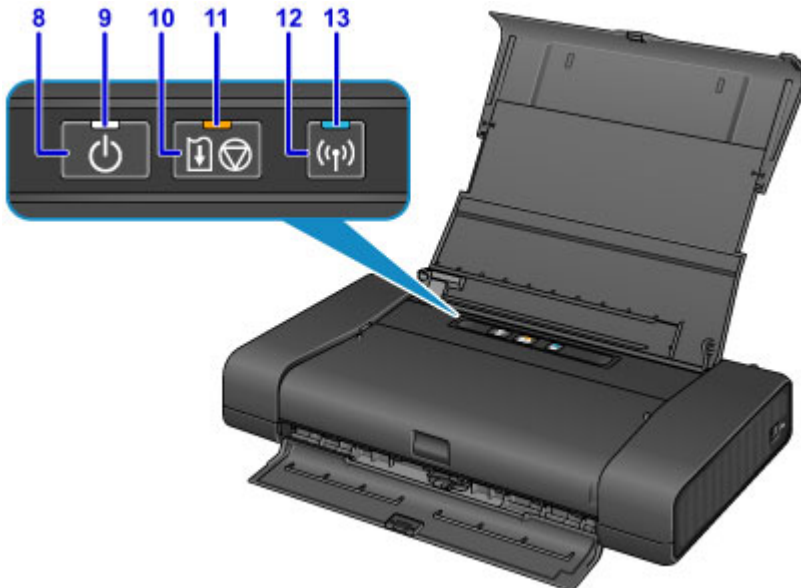

\* All lamps are shown lit in the above figure for explanatory purposes.

#### (8) ON button

Turns the power on or off.

■ [Turning the Printer On and Off](#)

#### (9) POWER lamp

Lights after flashing when the power is turned on.

### ▶▶▶ Note

- You can check the status of the printer by the **POWER** and **Alarm** lamps.
  - **POWER** lamp is off: The power is off.
  - **POWER** lamp lights: The printer is ready to print.
  - **POWER** lamp flashes: The printer is getting ready to print, or printing is in progress.
  - **Alarm** lamp flashes: An error has occurred and the printer is not ready to print.
  - **POWER** lamp flashes and **Alarm** lamp flashes alternately: An error that requires contacting the service center may have occurred.

■ [If an Error Occurs](#)

#### (10) RESUME/CANCEL button

Cancels a print job in progress. Holding this button down lets you select maintenance options or printer settings.

#### (11) Alarm lamp

Lights or flashes when an error occurs. When performing printer maintenance or printer settings, options can be selected according to the number of flashes.

#### (12) Wi-Fi button

Hold down to automatically set up the wireless LAN connection.

#### (13) Wi-Fi lamp

Lights or flashes to indicate the wireless LAN status.

##### Lights:

Wireless LAN connection is enabled.

##### Flashes:

Printing over wireless LAN. Also flashes while configuring the wireless LAN connection.

## Rear View

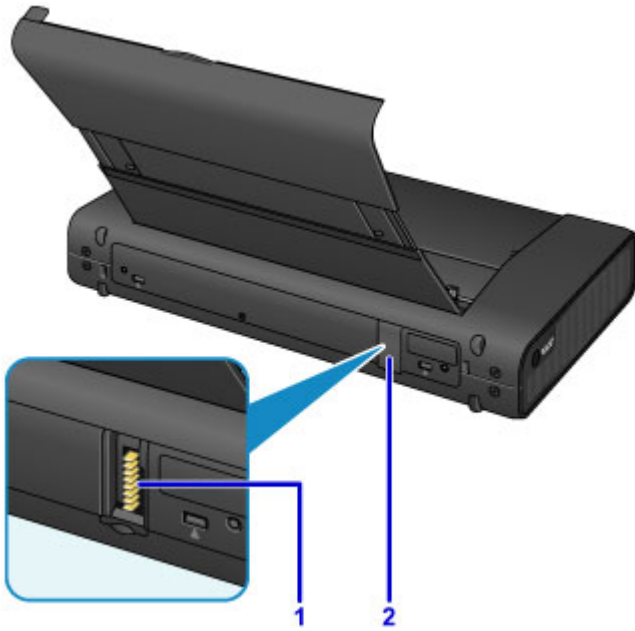

**(1) battery connector**

Connects the battery.

For how to connect and use the battery, refer to the battery's instruction manual.

**(2) battery connector cover**

Covers the battery connector. When the battery is unplugged from the connector, use this cover to protect the battery connector.

## Side View



### (1) AC adapter connector

Plug in the supplied universal AC adapter plug here.

### (2) USB port

Plug in the USB cable to connect the printer with a computer.

### ▶▶▶ Important

- Do not touch the metal casing.
- Do not plug in or unplug the USB cable while printing.

## Inside View

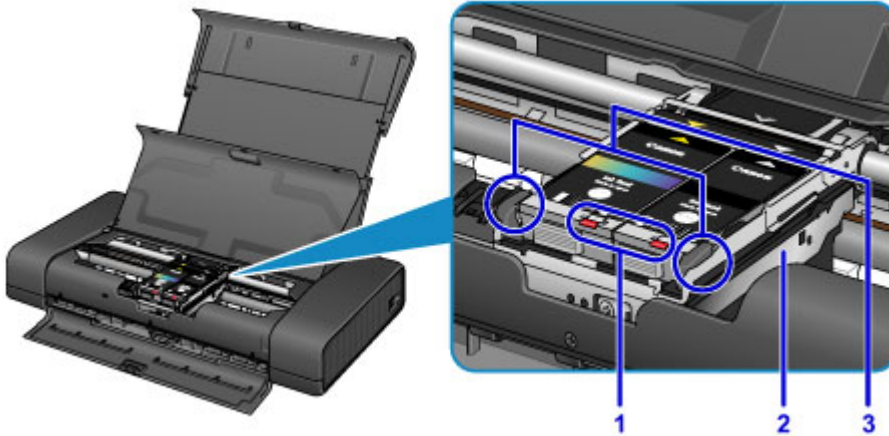

### (1) ink lamps

Lights or flashes to indicate the ink tank status.

■ [Checking the Ink Status with the Ink Lamps](#)

### (2) print head holder

Install the print head here.

### (3) print head lock lever

Locks the print head into place.

## ▶▶▶ Important

- Do not pull up this lever after installing the print head.
- If you pull up the print head lock lever after installing the print head, push both tabs in left to right order until each clicks into place.

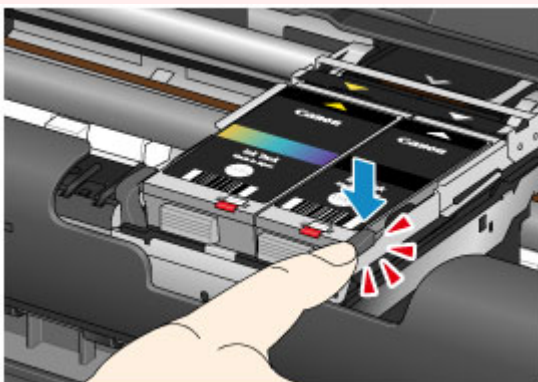
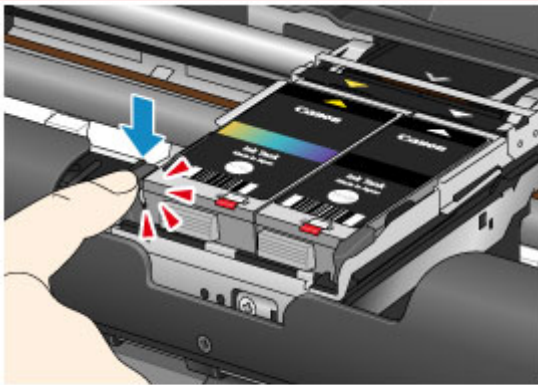

**»» Note**

- For details on replacing an ink tank, see [Replacing an Ink Tank](#).



## **About the Power Supply of the Printer**

- **Confirming that the Power Is On**
- **Turning the Printer On and Off**
- **Notice for the Power Plug/Power Cord**
- **Notice for Unplugging the Power Cord**

## Confirming that the Power Is On

The **POWER** lamp is lit when the printer is turned on.

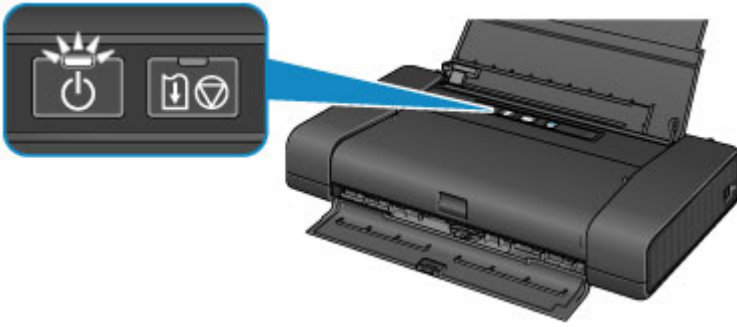

### ►► Note

- It may take a while for the printer to start printing immediately after you turn on the printer.

# Turning the Printer On and Off

## Turning on the printer

1. Open the rear tray cover.

The paper output slot cover opens automatically.

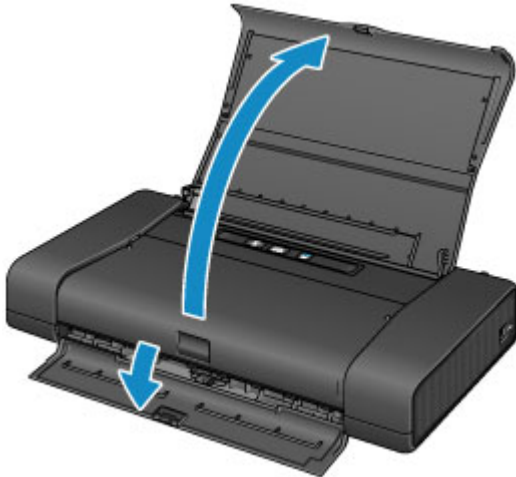

2. Press the **ON** button to turn on the printer.

The **POWER** lamp flashes and then remains lit.

### ■ [Confirming that the Power Is On](#)

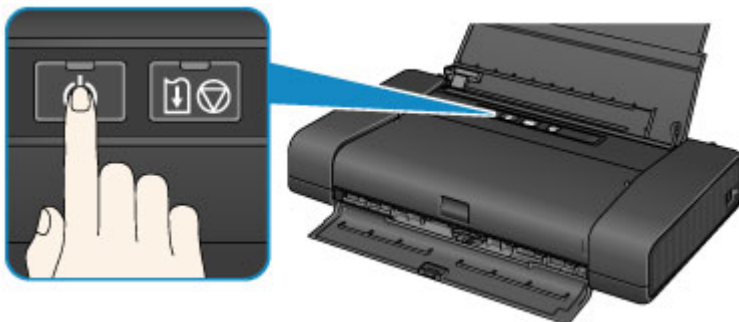

### ▶▶▶ **Note**

- It may take a while for the printer to start printing immediately after you turn on the printer.
- If the **Alarm** lamp flashes, see [If an Error Occurs](#).
- If you use the battery, make sure that it is charged. For details on how to check it, refer to the battery's instruction manual.

## Turning off the printer

1. Press the **ON** button to turn off the printer.

When the **POWER** lamp stops flashing, the printer is turned off.

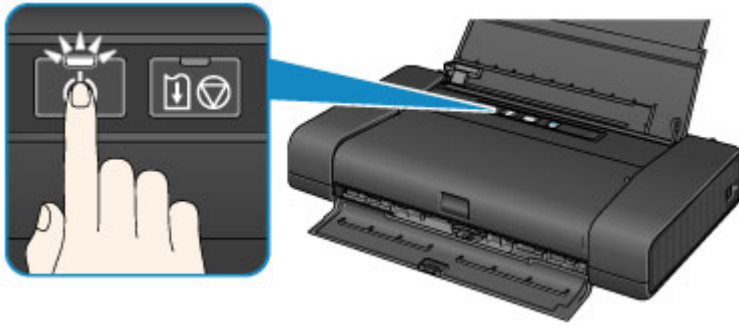

### ▶▶▶ Important

- When you [unplug the power cord](#) after turning off the printer, be sure to confirm that the **POWER** lamp is off.
- If you stand the printer up or carry the printer before the **POWER** lamp goes off, this may cause the ink to leak or the printer to break.

### ▶▶▶ Note

- It may take up to 40 seconds until the power is turned off.
- You can set the printer to automatically turn off when no print jobs are sent to the printer for a certain interval. This is the default setting.

■ [Managing the Printer Power](#)

## Notice for the Power Plug/Power Cord

Unplug the power cord once a month to confirm that the power plug/power cord does not have anything unusual described below.

- The power plug/power cord is hot.
- The power plug/power cord is rusty.
- The power plug/power cord is bent.
- The power plug/power cord is worn.
- The power plug/power cord is split.

### **Caution**

- If you find anything unusual with the power plug/power cord described above, [unplug the power cord](#) and call for service. Using the printer with one of the unusual conditions above may cause a fire or an electric shock.

## Notice for Unplugging the Power Cord

To unplug the power cord, follow the procedure below.

### ▶▶▶ Important

- When you unplug the power cord, press the **ON** button, then confirm that the **POWER** lamp is off. Unplugging the power cord before the **POWER** lamp is turned off may cause drying or clogging of the print head and print quality may be reduced.
- If you stand the printer up or carry the printer before the **POWER** lamp goes off, this may cause the ink to leak or the printer to break.

1. Press the **ON** button to turn the printer off.

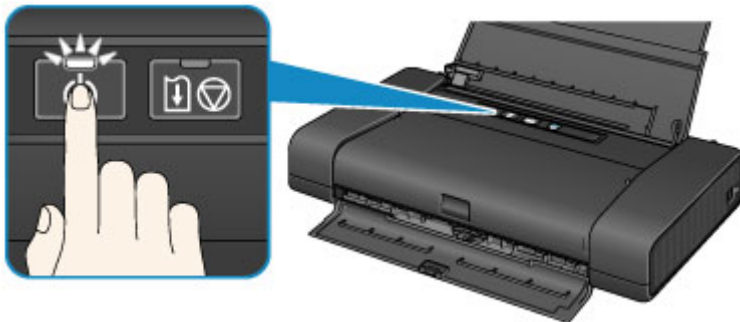

2. Confirm that the **POWER** lamp is off.

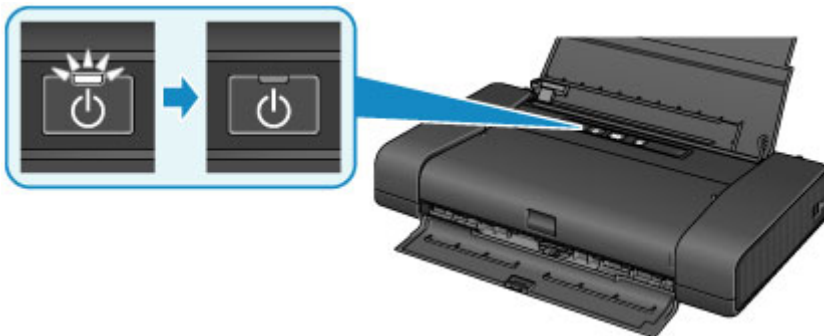

3. Unplug the power cord.

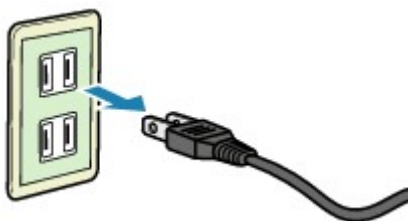

The specification of the power cord differs depending on the country or region of use.

## Loading Paper

- ▶ Loading Paper

## **Loading Paper**

- ▶ **Loading Plain Paper / Photo Paper**
- ▶ **Loading Envelopes**
- ▶ **Media Types You Can Use**
- ▶ **Media Types You Cannot Use**
- ▶ **Printing Area**



## Loading Plain Paper / Photo Paper

You can load plain paper or photo paper.

### ▶▶▶ Important

- If you cut plain paper into small size such as 4" x 6" (10 x 15 cm) or 5" x 7" (13 x 18 cm) to perform trial print, it can cause paper jams.

### ▶▶▶ Note

- We recommend Canon genuine photo paper for printing photos.  
For details on the Canon genuine paper, see [Media Types You Can Use](#).
- You can use general copy paper.
- For the page size and paper weight you can use for this printer, see [Media Types You Can Use](#).
- For loading envelopes, see [Loading Envelopes](#).

#### 1. Prepare paper.

Align the edges of paper. If paper is curled, flatten it.

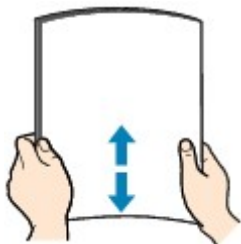

### ▶▶▶ Note

- Align the edges of paper neatly before loading. Loading paper without aligning the edges may cause paper jams.
- If paper is curled, hold the curled corners and gently bend them in the opposite direction until the paper becomes completely flat.

For details on how to flatten curled paper, see "Load the paper after correcting its curl." in [Paper Is Smudged/Printed Surface Is Scratched](#).

#### 2. Open the rear tray cover (A).

The paper output slot cover will open automatically.

#### 3. Pull out the paper support (B) until the arrow (▶) mark is aligned with the arrow (◀) mark.

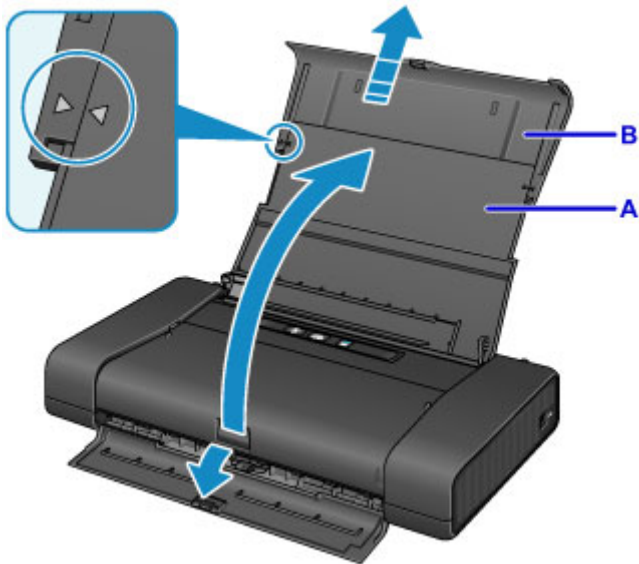

4. Slide the paper guide (C) to the left, and load the paper against the far right (D) of the rear tray WITH THE PRINT SIDE FACING YOU.
5. Slide the paper guide (C) to align it with the paper stack.

Do not slide the paper guide too hard against the paper. The paper may not be fed properly.



### »» Important

- Always load paper in the portrait orientation (E). Loading paper in the landscape orientation (F) can cause paper jams.

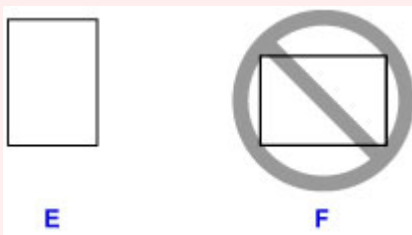

### ▶▶▶ Note

- If paper has print side (front or back), such as photo paper, load it with the whiter side (or glossy side) facing you.
- Keep the paper stack height below the tab (G) of the paper guide.

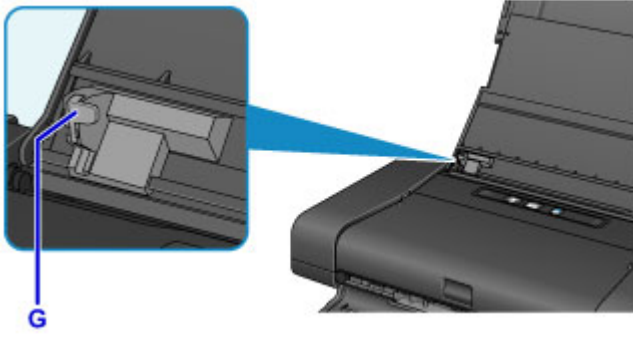

6. Set the paper thickness lever (H) to the right.

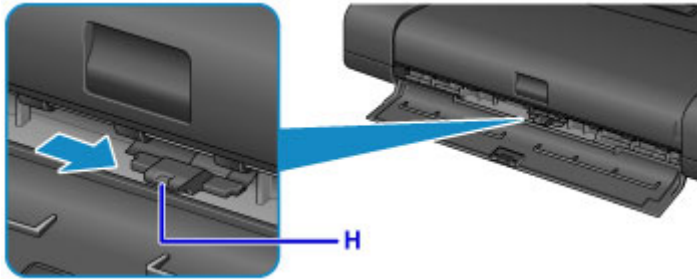

### ▶▶▶ Note

- If the corners or edges of the paper are smudged, try to print with the paper thickness lever set to the left. It may improve print quality. Reset the paper thickness lever to the right when you finish printing.

### ▶▶▶ Note

- When printing, select the size and type of the loaded paper on the print settings screen of the printer driver.

# Loading Envelopes

You can load Envelope DL and Envelope Com 10.

The address is automatically rotated and printed according to the envelope's direction by specifying with the printer driver properly.

## ▶▶▶ Important

- Printing of envelopes from a digital camera is not supported.
- Do not use the following envelopes. They could jam in the printer or cause the printer to malfunction.
  - Envelopes with an embossed or treated surface
  - Envelopes with a double flap
  - Envelopes whose gummed flaps are already moistened and adhesive

### 1. Prepare envelopes.

- Press down on all four corners and edges of the envelopes to flatten them.

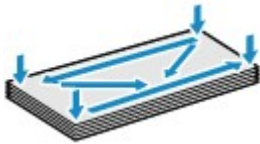

- If the envelopes are curled, hold the opposite corners and gently twist them in the opposite direction.



- If the corner of the envelope flap is folded, flatten it.
- Use a pen to press the leading edge in the inserting direction flat and sharpen the crease.

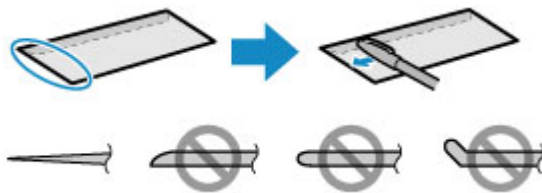

The figures above show a side view of the leading edge of the envelope.

## ▶▶▶ Important

- The envelopes may jam in the printer if they are not flat or the edges are not aligned. Make sure that no curl or puff exceeds 0.1 inch (3 mm).

### 2. Open the rear tray cover (A).

The paper output slot cover will open automatically.

### 3. Pull out the paper support (B) until the arrow (▶) mark is aligned with the arrow (◀) mark.

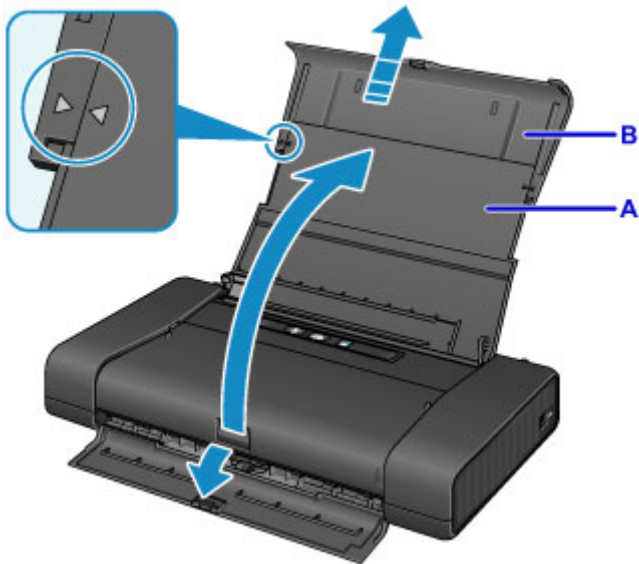

- Slide the paper guide (C) to the left, and load the envelopes against the far right (D) of the rear tray WITH THE PRINT SIDE FACING YOU.

The folded flap of the envelope will be faced up on the left side.

Up to 10 envelopes can be loaded at once.

- Slide the paper guide (C) to align it with the envelopes.

Do not slide the paper guide too hard against the envelopes. The envelopes may not be fed properly.

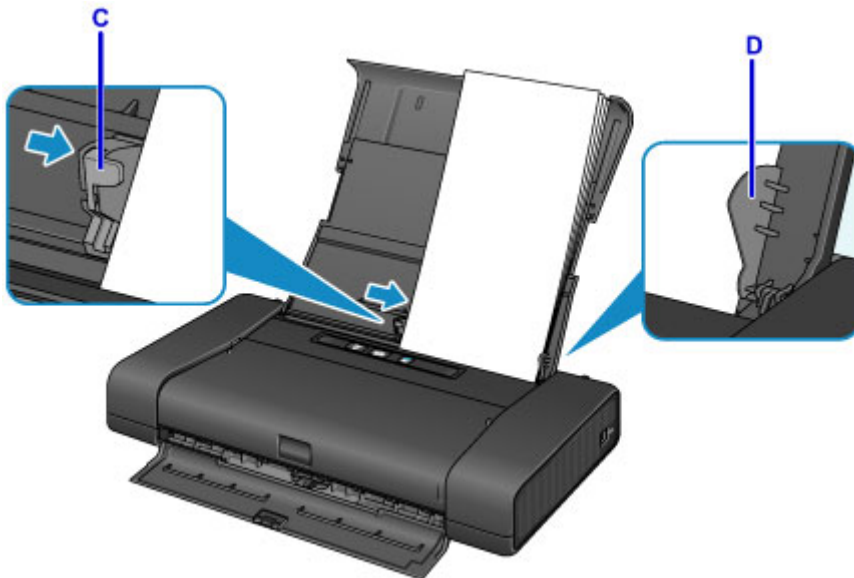

E



F

E: Rear side

F: Address side

**▶▶▶ Note**

- Keep the envelope stack height below the tab (G) of the paper guide.

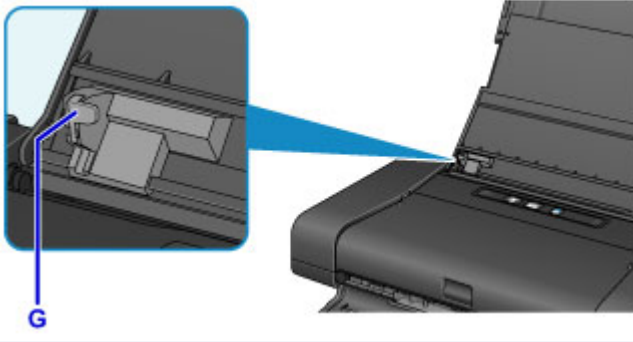

6. Set the paper thickness lever (H) to the left.

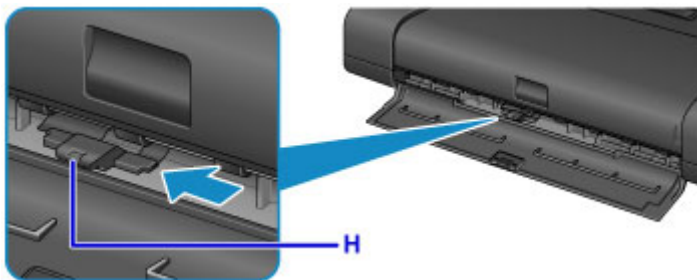

**▶▶▶ Note**

- Reset the paper thickness lever to the right when you finish printing.

**▶▶▶ Note**

- When printing, select the size and type of the loaded envelopes on the print settings screen of the printer driver.

# Media Types You Can Use

Choose paper suitable for printing, for the best print results. Canon provides you various types of paper to enhance the fun of printing, such as stickers as well as papers for photo or document. We recommend the use of Canon genuine paper for printing your important photos.

## Media Types

### Commercially available papers

- Plain Paper (including recycled paper)
- Envelopes\*[1](#)

### Canon genuine papers

The Model Number of Canon genuine paper is shown in brackets. Refer to the instruction manual supplied with the paper for detailed information on the printable side and notes on handling paper. For information on the page sizes available for each Canon genuine paper, access our website.

#### ▶▶▶ Note

- You may not be able to purchase some Canon genuine papers depending on the country or region of purchase. Paper is not sold in the US by Model Number. Purchase paper by name.

#### Paper for printing photos:

- Glossy Photo Paper "Everyday Use" <GP-501/GP-601>\*[1](#)
- Photo Paper Glossy <GP-601>\*[1](#)
- Photo Paper Plus Glossy II <PP-201>
- Matte Photo Paper <MP-101>\*[1](#)

#### Paper for creating your own prints:

- Photo Stickers <PS-101>

\*1 Printing to this paper from a digital camera is not supported.

■ [Paper Load Limit](#)

■ [Paper Settings on the Printer Driver](#)

#### ▶▶▶ Note

- When printing photos saved on a PictBridge compliant device, you must specify the page size and media type.

■ [Printing from a Digital Camera](#)

## Page Sizes

You can use the following page sizes.

#### ▶▶▶ Note

- Printing on the following paper sizes from a digital camera is not supported.
  - B5, A5, Legal, and Envelopes

**Standard sizes:**

- Letter
- Legal
- A5
- A4
- B5
- 4" x 6" (10 x 15 cm)
- 5" x 7" (13 x 18 cm)
- 8" x 10" (20 x 25 cm)
- Envelope DL
- Envelope Com 10

**Non-standard sizes:**

You can print on non-standard size paper within the following ranges.

- Minimum size: 2.17 x 3.58 inches (55.0 x 91.0 mm)
- Maximum size: 8.50 x 23.00 inches (215.9 x 584.2 mm)

**Paper Weight**

You can use paper in the following weight range.

- 17 to 28 lb (64 to 105 g /m<sup>2</sup>) (plain paper except for Canon genuine paper)

Do not use heavier or lighter paper (except for Canon genuine paper), as it could jam in the printer.

**Notes on Storing Paper**

- Take out only the necessary number of paper from the package, just before printing.
- To avoid curling, when you do not print, put unused paper back into the package and keep it on a level surface. And also, store it avoiding heat, humidity, and direct sunlight.



# Paper Load Limit

## Commercially Available Papers

Media Name	Rear Tray	Paper Thickness Lever*1	Limit of the Outputted Paper
Plain Paper (including recycled paper)*2	Approx. 50 sheets	Right	Approx. 10 sheets
Envelopes	10 envelopes	Left	5 envelopes

## Canon Genuine Papers

### ▶▶▶ Note

- We recommend that you remove the previously printed sheet from the paper output slot cover before continuously printing to avoid blurs and discoloration.

### Paper for printing photos:

Media Name <Model No.>	Rear Tray	Paper Thickness Lever*1
Glossy Photo Paper "Everyday Use" <GP-501/GP-601>*3	10 sheets	Right
Photo Paper Glossy <GP-601>*3	10 sheets	Right
Photo Paper Plus Glossy II <PP-201>*3	10 sheets	Right
Matte Photo Paper <MP-101>	10 sheets	Right

### Paper for creating your own prints:

Media Name <Model No.>	Rear Tray	Paper Thickness Lever*1
Photo Stickers <PS-101>	1 sheet	Right

\*1 If the corners or edges of the paper are smudged, try to print with the paper thickness lever set to the left. It may improve print quality. Reset the paper thickness lever when you finish printing.

#### ■ [Front View](#)

\*2 Proper feeding of paper may not be possible at the maximum capacity depending on the type of paper or environmental conditions (either very high or low temperature or humidity). In such cases, reduce the number of paper you load at a time to less than half.

\*3 When loading paper in stacks, the print side may become marked as it is fed or paper may not feed properly. In this case, load one sheet at a time.

## Media Types You Cannot Use

Do not use the following types of paper. Using such paper will cause not only unsatisfactory results, but also the printer to jam or malfunction.

- Folded, curled, or wrinkled paper
- Damp paper
- Paper that is too thin (weighing less than 17 lb (64 g /m<sup>2</sup>))
- Paper that is too thick (plain paper weighing more than 28 lb (105 g /m<sup>2</sup>), except for Canon genuine paper)
- Paper thinner than a postcard, including plain paper or notepad paper cut to a small size (when printing on paper smaller than A5)
- Picture postcards
- Postcards affixed with photos or stickers
- Envelopes with a double flap
- Envelopes with an embossed or treated surface
- Envelopes whose gummed flaps are already moistened and adhesive
- Any type of paper with holes
- Paper that is not rectangular
- Paper bound with staples or glue
- Paper with adhesives
- Paper decorated with glitter, etc.

## **Printing Area**

- ▶ **Printing Area**
- ▶ **Other Sizes than Letter, Legal, Envelopes**
- ▶ **Letter, Legal**
- ▶ **Envelopes**

## Printing Area

To ensure the best print quality, the printer allows a margin along each edge of media. The actual printable area will be the area inside these margins.

Recommended printing area  : Canon recommends that you print within this area.

Printable area  : The area where it is possible to print. However, printing in this area can affect the print quality or the paper feed precision.

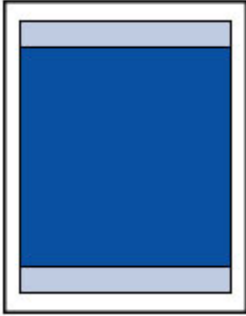

### »» Note

- By selecting Borderless Printing option, you can make prints with no margins.
- When performing Borderless Printing, slight cropping may occur at the edges since the printed image is enlarged to fill the whole page.
- For Borderless Printing, use the following paper:
  - Glossy Photo Paper "Everyday Use" <GP-501/GP-601>
  - Photo Paper Glossy <GP-601>
  - Photo Paper Plus Glossy II <PP-201>
  - Matte Photo Paper <MP-101>

Performing Borderless Printing on any other type of paper may substantially reduce printing quality and/or result in printouts with altered color hues.

Borderless Printing on plain paper may result in printouts with reduced quality. Use them only for test printing.

- Borderless Printing is not available for legal, A5, or B5 sized paper, or envelopes.
- Depending on the type of paper, Borderless Printing may reduce the print quality at the top and bottom edges of the paper or cause these parts to become smudged.

## Other Sizes than Letter, Legal, Envelopes

Size	Printable Area (width x height)
A5	5.56 x 7.95 inches (141.2 x 202.0 mm)
A4	8.00 x 11.38 inches (203.2 x 289.0 mm)
B5	6.90 x 9.80 inches (175.2 x 249.0 mm)
4" x 6" (10 x 15 cm)	3.73 x 5.69 inches (94.8 x 144.4 mm)
5" x 7" (13 x 18 cm)	4.73 x 6.69 inches (120.2 x 169.8 mm)
8" x 10" (20 x 25 cm)	7.73 x 9.69 inches (196.4 x 246.0 mm)

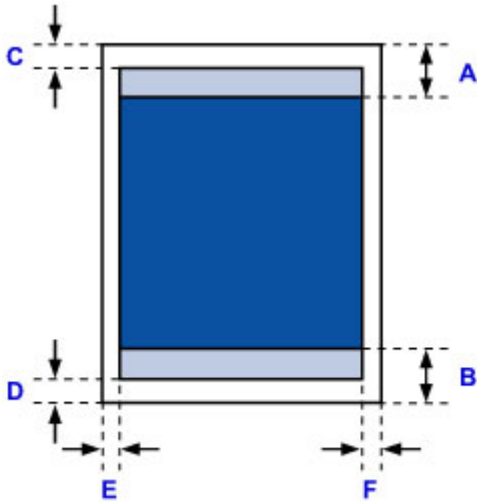

Recommended printing area

A: 1.81 inches (46.0 mm)

B: 1.38 inches (35.0 mm)

Printable area

C: 0.12 inch (3.0 mm)

D: 0.20 inch (5.0 mm)

E: 0.13 inch (3.4 mm)

F: 0.13 inch (3.4 mm)

## Letter, Legal

Size	Printable Area (width x height)
Letter	8.00 x 10.69 inches (203.2 x 271.4 mm)
Legal	8.00 x 13.69 inches (203.2 x 347.6 mm)

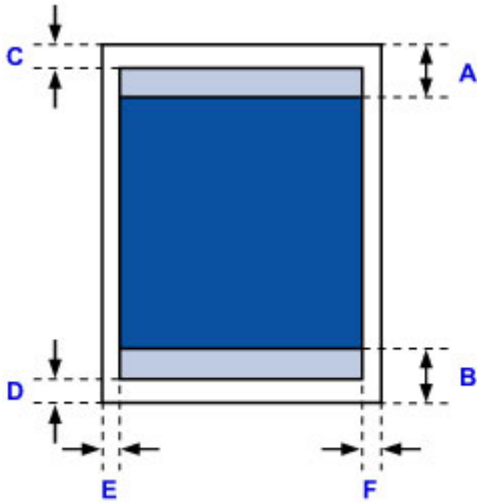

Recommended printing area

A: 1.81 inches (46.0 mm)

B: 1.38 inches (35.0 mm)

Printable area

C: 0.12 inch (3.0 mm)

D: 0.20 inch (5.0 mm)

E: 0.25 inch (6.4 mm)

F: 0.25 inch (6.3 mm)

# Envelopes

Size	Recommended Printing Area (width x height)
Envelope DL	4.06 x 7.50 inches (103.2 x 190.5 mm)
Envelope Com 10	3.85 x 8.34 inches (98.0 x 211.8 mm)

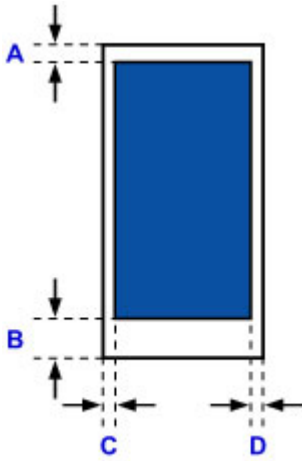

 Recommended printing area

A: 0.12 inch (3.0 mm)

B: 1.04 inches (26.5 mm)

C: 0.13 inch (3.4 mm)

D: 0.13 inch (3.4 mm)

## Replacing an Ink Tank

- ▶ [Replacing an Ink Tank](#)
- ▶ [Checking the Ink Status](#)



# Replacing an Ink Tank

When remaining ink cautions or errors occur, the **Alarm** lamp will flash to inform you of the error. Count the number of flashes and take appropriate action.

## ■ [If an Error Occurs](#)

### ▶▶▶ Note

- If print results become faint or white streaks appear despite sufficient ink levels, see [Maintenance Procedure](#).

## Replacing Procedure

When you need to replace an ink tank, follow the procedure below.

### ▶▶▶ Important

- If you remove an ink tank, replace it immediately. Do not leave the printer with the ink tank removed.
- Use a new ink tank for replacement. Installing a used ink tank may cause the nozzles to clog. Furthermore, with such an ink tank, the printer will not be able to inform you when to replace the ink tank properly.
- Once an ink tank has been installed, do not remove it from the printer and leave it out in the open. This will cause the ink tank to dry out, and the printer may not operate properly when it is reinstalled. To maintain optimal printing quality, use an ink tank within six months of first use.

### ▶▶▶ Note

- Color ink may be consumed even when printing a black-and-white document or when black-and-white printing is specified.

Every ink is also consumed in the standard cleaning and deep cleaning of the print head, which may be necessary to maintain the performance of the printer. When an ink tank is out of ink, replace it immediately with a new one.

## ■ [Useful Information about Ink](#)

1. Make sure that the power is turned on.
2. Open the print head cover.

The print head holder moves to the replacement position.

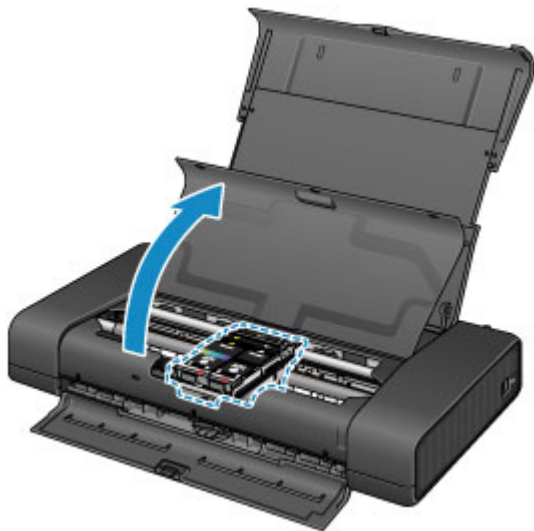

### ⚠ Caution

- Do not hold the print head holder to stop or move it forcibly. Do not touch the print head holder until it stops completely.

### ➤➤ Important

- Do not place any object on the print head cover. It will fall into the rear tray when the print head cover is opened and cause the printer to malfunction.
- Do not touch the metallic parts or other parts inside the printer.
- If the print head cover is left open for more than 10 minutes, the print head holder moves to the right. In this case, close and reopen the print head cover.

### 3. Remove the ink tank with the lamp flashing fast.

Push the tab (A) and lift the ink tank to remove.

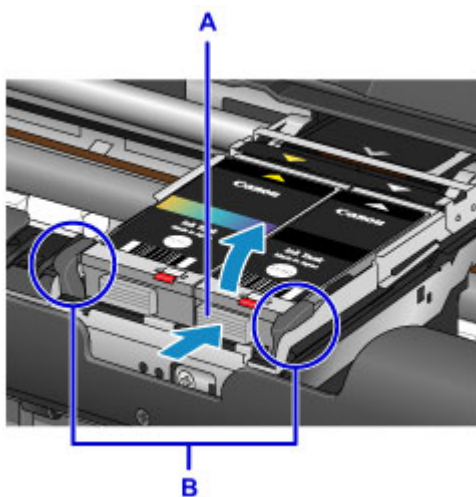

### ➤➤ Important

- Do not touch other parts besides the ink tanks.
- Handle the ink tank carefully to avoid staining of clothing or the surrounding area.
- Discard the empty ink tank according to the local laws and regulations regarding disposal of consumables.

## ►► Note

- Do not touch the print head lock lever (B).  
If you pull up the print head lock lever, lock it again.

### ■ Inside View

- Do not remove both ink tanks at the same time. Be sure to replace ink tanks one by one when replacing both ink tanks.
- For details on ink lamp flashing speed, see [Checking the Ink Status with the Ink Lamps](#).

4. Remove the new ink tank from its packaging, then remove the protective cap (C) from the bottom of the ink tank.

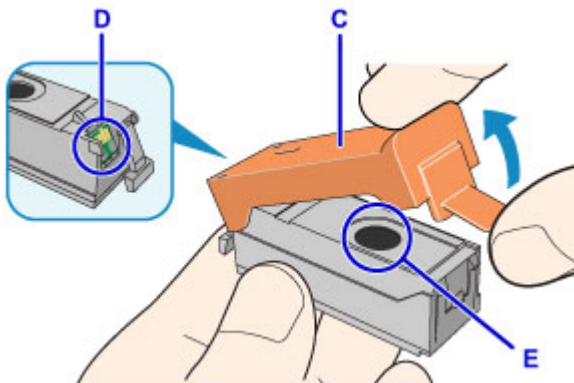



## ►► Important

- Do not touch the electrical contacts (D) on the ink tank.  
Doing so can cause the printer to malfunction or become unable to print.
- Shaking ink tanks may cause ink to spill out and stain clothing or the surrounding area. Handle ink tanks carefully.
- Do not touch the inside of the protective cap (C) or the open ink port (E). The ink may stain your hands if you touch them.
- Do not reattach the protective cap (C) once you have removed it. Discard it according to the local laws and regulations regarding disposal of consumables.
- Do not touch the open ink port (E) once the protective cap (C) is removed, as this may prevent the ink from being ejected properly.

5. Insert the front end of the ink tank into the print head at a slant.

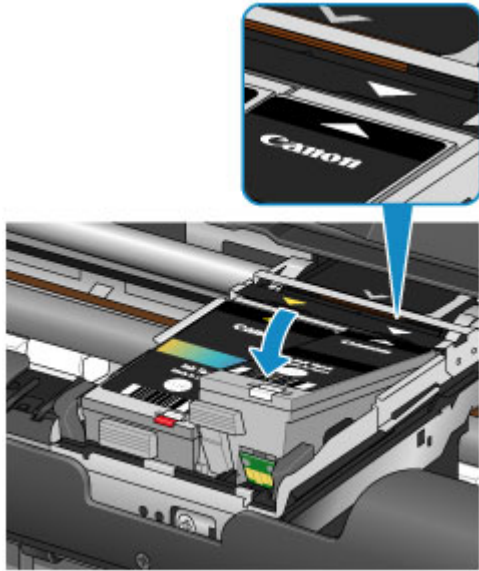
Align the ▽ mark with the △ mark.



6. Press the  mark on the ink tank until the ink tank snaps firmly into place.

Make sure that the ink lamp lights up.

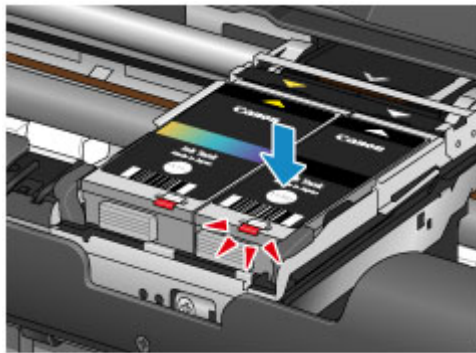

### ▶▶▶ Important

- Install both ink tanks to print. The printer cannot be used unless both ink tanks are installed.
- If the front (innermost) part of the ink tank (F) is sticking up, push down on the Canon logo on the ink tank. Do not remove the ink tank forcibly.

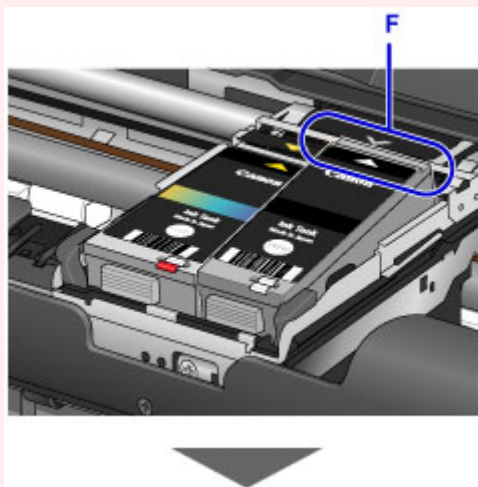



7. Close the print head cover.

▶▶▶ **Note**

- If the **Alarm** lamp still flashes after the print head cover is closed, take appropriate action.
  - [If an Error Occurs](#)
- When you start printing after replacing the ink tank, the printer starts cleaning the print head automatically. Do not perform any other operations until the printer completes the cleaning of the print head. While cleaning is in progress, the **POWER** lamp is flashing.
- If the print head is out of alignment, as indicated by misaligned printed ruled lines or similar symptoms, [align the print head](#).

## Checking the Ink Status from Your Computer

You can check the detailed information such as the remaining ink level and the ink tank types of your model.

1. Select **Ink Level Information** from the pop-up menu on the [Canon IJ Printer Utility](#)

An illustration of the ink types and their status is displayed.

If a warning or error related to the remaining ink level occurs, the printer driver displays an icon to let you know.

2. If necessary, click **Ink Details**

You can check the ink-related information.

### ▶▶ Note

- **Ink Details** is displayed when the ink level is low.
- Click  to check which ink tank your model uses.
- Click **Update** to display the current remaining ink level.
- When you receive a notice about the remaining ink level, a mark appears above the ink icon.

For example:



Ink tank is running low. Prepare a new ink tank.

## Checking the Ink Status

- ▶ **Checking the Ink Status with the Ink Lamps**

You can also check the ink status on the computer screen.

- ▶ **Checking the Ink Status from Your Computer**

# Checking the Ink Status with the Ink Lamps

1. Make sure that the power is turned on.
2. Open the print head cover.

■ [Replacing Procedure](#)

3. Check the ink lamp.

Close the print head cover after checking the ink lamp status.

■ [Replacing Procedure](#)

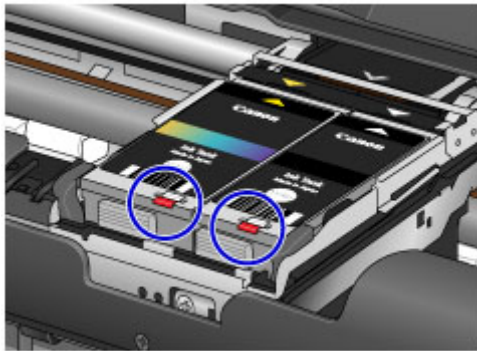

- The ink lamp is on.  
The ink tank is correctly installed.
- The ink lamp is flashing.

### Flashing slowly (at around 3-second intervals)



Ink tank is running low. Prepare a new ink tank.

### Flashing fast (at around 1-second intervals)



Ink has run out. Replace it with a new one.

- The ink lamp is off.  
The ink tank is not installed properly or the function for detecting the remaining ink level is disabled. If the ink tank is not firmly in place, press the  mark on the ink tank until the ink tank clicks into place.

If the ink lamp is still off after reinstalling the ink tank, there has been an error and the printer cannot print. Check the **Alarm** lamp on the printer.

■ [If an Error Occurs](#)

## ▶▶▶ Note

- You can also check the ink status on the computer screen.

■ [Checking the Ink Status from Your Computer](#)



## **Maintenance**

- **When Printing Becomes Faint or Colors Are Incorrect**
- **Performing Maintenance from a Computer**
- **Cleaning the Printer**

## **When Printing Becomes Faint or Colors Are Incorrect**

- **Maintenance Procedure**
- **Printing the Nozzle Check Pattern**
- **Examining the Nozzle Check Pattern**
- **Cleaning the Print Head**
- **Aligning the Print Head**

# Maintenance Procedure

If print results are blurred, colors are not printed correctly, or print results are unsatisfactory (e.g. misaligned printed ruled lines), perform the maintenance procedure below.

## ▶▶▶ Important

- Do not rinse or wipe the print head and ink tank. This can cause trouble with the print head and ink tank.

## ▶▶▶ Note

- Open the print head cover and make sure that both lamps on the ink tanks are lit. If the lamps are flashing or off, take appropriate action.
  - [Checking the Ink Status with the Ink Lamps](#)
- Increasing the print quality in the printer driver settings may improve the print result.
  - [Changing the Print Quality and Correcting Image Data](#)

## When the Print Results Are Blurred or Uneven:

|| Step1 Print the nozzle check pattern.

From the printer

- [Printing the Nozzle Check Pattern](#)

From the computer

- [Use Your Computer to Print a Nozzle Check Pattern](#)

|| Step2 [Examine the nozzle check pattern.](#)

If there are missing lines or horizontal white streaks in the pattern:



|| Step3 Clean the print head.

From the printer

- [Cleaning the Print Head](#)

From the computer

- [Cleaning the Print Heads from Your Computer](#)

After cleaning the print head, print and examine the nozzle check pattern: ➔ [Step1](#)

If the problem is not resolved after performing from step 1 to step 3 twice:



|| Step4 Clean the print head deeply.

From the computer

- [Cleaning the Print Heads from Your Computer](#)

## ►► Note

- When you have performed the procedure until step 4 and the problem has not been resolved, turn off the power and clean the print head deeply again after 24 hours.  
If the problem is still not resolved, the print head may be damaged. Contact the service center.

## When the Print Results Are Not Even such as the Ruled Lines Are Misaligned:

|| Step | Align the print head.

From the printer

- [Aligning the Print Head](#)

From the computer

- [Aligning the Print Head Position from Your Computer](#)

## Printing the Nozzle Check Pattern

Print the nozzle check pattern to determine whether the ink ejects properly from the print head nozzle.

### ▶▶ Note

- If the remaining ink level is low, the nozzle check pattern will not be printed correctly. [Replace the ink tank](#) whose ink is low.

**You need to prepare: a sheet of A4 or Letter-sized plain paper**

1. Make sure that the power is turned on.
2. Load a sheet of A4 or Letter-sized plain paper in the rear tray.
3. Set the paper thickness lever to the right.

#### ■ [Loading Paper](#)

4. Hold down the **RESUME/CANCEL** button until the **POWER** lamp flashes twice, then release it immediately.

The nozzle check pattern will be printed.

Do not perform any other operations until the printer completes the printing of the nozzle check pattern.

5. [Examine the nozzle check pattern.](#)

# Examining the Nozzle Check Pattern

Examine the nozzle check pattern, and clean the print head if necessary.

1. Check if there are missing lines in the pattern A or horizontal white streaks in the pattern B.

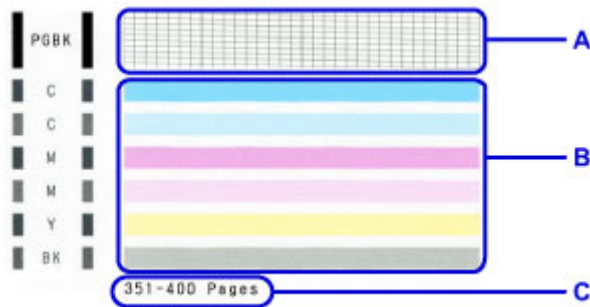

C: Number of sheets printed so far

**If there are missing lines in the pattern A:**

[Cleaning the print head](#) of the Black ink is required.



D: Good

E: Bad (lines are missing)

**If there are horizontal white streaks in the pattern B:**

[Cleaning the print head](#) of the Color ink is required.



F: Good

G: Bad (horizontal white streaks are present)

## ►► Note

- The total number of sheets printed so far is shown in increments of 50 sheets on the printout of the nozzle check pattern.

## Cleaning the Print Head

Clean the print head if lines are missing or if horizontal white streaks are present in the printed nozzle check pattern. Cleaning unclogs the nozzles and restores the print head condition. Cleaning the print head consumes ink, so clean the print head only when necessary.

1. Make sure that the power is turned on.
2. Hold down the **RESUME/CANCEL** button until the **POWER** lamp flashes once, then release it immediately.

The printer starts cleaning the print head.

The cleaning will be complete when the **POWER** lamp lights after flashing.

Do not perform any other operations until the printer completes the cleaning of the print head. This takes about 1 to 2 minutes.

3. Check the print head condition.

[Print the nozzle check pattern](#) to check the print head condition.

### Note

- If the problem is not resolved after cleaning the print head twice, clean the print head deeply.

■ [Cleaning the Print Heads from Your Computer](#)

## Aligning the Print Head

If printed ruled lines are misaligned or print results are otherwise unsatisfactory, adjust the print head position.

### ▶▶▶ Note

- If the remaining ink level is low, the print head alignment sheet will not be printed correctly. [Replace the ink tank](#) whose ink is low.
- If you run out of the supplied paper (Matte Photo Paper MP-101) or the specified Canon genuine paper is not immediately available or obtainable, you can use plain paper and adjust the print head position manually from a computer.

■ [Aligning the Print Head Position Manually from Your Computer](#)

**You need to prepare: a sheet of A4 or Letter-sized Matte Photo Paper MP-101**

1. Make sure that the power is turned on.
2. Load a sheet of supplied paper or A4 or Letter-sized Matte Photo Paper MP-101 in the rear tray.

Load the paper WITH THE PRINT SIDE (WHITER SIDE) FACING YOU in the rear tray.

3. Set the paper thickness lever to the right.

■ [Loading Paper](#)

4. Hold down the **RESUME/CANCEL** button until the **POWER** lamp flashes four times, then release it immediately.

The print head alignment sheet will be printed and the print head position will be adjusted automatically.

Do not perform any other operations until the printer completes the printing of the print head alignment sheet. This takes about 4 minutes.

### ▶▶▶ Note

- If the automatic adjustment of the print head position has failed, the **Alarm** lamp flashes.

■ [If an Error Occurs](#)

- If the print results are still not satisfactory after adjusting the print head position as described above, adjust the print head position manually from the computer.

■ [Aligning the Print Head Position Manually from Your Computer](#)



## **Performing Maintenance from a Computer**

- **Cleaning the Print Heads from Your Computer**
- **Cleaning Inside the Printer**
- **Cleaning the Paper Feed Rollers from Your Computer**
- **Use Your Computer to Print a Nozzle Check Pattern**
- **Aligning the Print Head**
- **Aligning the Print Head Position from Your Computer**
- **Checking the Ink Status from Your Computer**
- **Checking the Current Battery Level**

# Cleaning the Print Heads from Your Computer

The print head cleaning function allows you to clear up clogged print head nozzle. Perform print head cleaning if printing is faint or a specific color fails to print, even though there is enough ink.

The procedure for cleaning the print head is as follows:

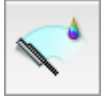

## Cleaning

1. Select **Cleaning** from the pop-up menu on the [Canon IJ Printer Utility](#)

2. Click the **Cleaning** icon

When the dialog opens, select the ink group for which cleaning is to be performed.

Click  to display the items you need to check before performing cleaning.

3. Execute cleaning

Make sure that the printer is on and then click **OK**.

Print head cleaning starts.

4. Complete cleaning

The **Nozzle Check** dialog opens after the confirmation message.

5. Check the results

To check whether the print quality has improved, click **Print Check Pattern**. To cancel the check process, click **Cancel**.

If cleaning the head once does not resolve the print head problem, clean it once more.

## »» Important

- **Cleaning** consumes a small amount of ink.  
Cleaning the print head frequently will rapidly deplete your printer's ink supply. Consequently, perform cleaning only when necessary.



## Deep Cleaning

**Deep Cleaning** is more thorough than cleaning. Perform deep cleaning when two **Cleaning** attempts do not resolve the print head problem.

1. Select **Cleaning** from the pop-up menu on the [Canon IJ Printer Utility](#)

2. Click the **Deep Cleaning** icon

When the dialog opens, select the ink group for which deep cleaning is to be performed.

Click  to display the items you need to check before performing deep cleaning.

### 3. Execute deep cleaning

Make sure that the printer is on and then click **OK**.

Click **OK** when the confirmation message appears.

Print head deep cleaning starts.

### 4. Complete deep cleaning

The **Nozzle Check** dialog opens after the confirmation message.

### 5. Check the results

To check whether the print quality has improved, click **Print Check Pattern**. To cancel the check process, click **Cancel**.

## Important

- **Deep Cleaning** consumes a larger amount of ink than **Cleaning**.  
Cleaning the print head frequently will rapidly deplete your printer's ink supply. Consequently, perform cleaning only when necessary.

## Note

- If there is no sign of improvement after **Deep Cleaning**, turn off the printer, wait 24 hours, and then perform **Deep Cleaning** again. If there is still no sign of improvement, the ink may have run out or the print head may be worn. For details on the remedial action to be taken, see "[Ink Is Not Ejected](#)."

## Related Topic

- [Use Your Computer to Print a Nozzle Check Pattern](#)

## Cleaning Inside the Printer

To prevent smudges on the back side of the paper, perform bottom plate cleaning.

Also perform bottom plate cleaning if ink smudges caused by something other than print data appear on the printed page.

The procedure for performing bottom plate cleaning is as follows:



### Bottom Plate Cleaning

1. Select **Cleaning** from the pop-up menu on the [Canon IJ Printer Utility](#)
2. Click the **Bottom Plate Cleaning** icon

The dialog opens.

3. Set the paper thickness lever to the right, and load paper in the printer

As instructed in the dialog box, load a sheet of A4 or Letter size plain paper into the rear tray.

Prepare a second sheet of A4 or Letter size plain paper, fold it in half horizontally, and then unfold it.

Load the second sheet in front of the first sheet so that it is oriented vertically with the crest of the crease facing down.

4. Perform the bottom plate cleaning

Make sure that the printer is on and then click **OK**.

Bottom plate cleaning starts.

# Cleaning the Paper Feed Rollers from Your Computer

Cleans the paper feed rollers. Perform feed roller cleaning when there are paper particles sticking to the paper feed rollers and paper is not fed properly.

The procedure for performing the feed roller cleaning is as follows:



## Roller Cleaning

1. Prepare the printer

Remove all sheets of paper from the rear tray, and set the paper thickness lever to the right.

2. Select **Cleaning** from the pop-up menu on the [Canon IJ Printer Utility](#)

3. Click the **Roller Cleaning** icon

The confirmation message appears.

4. Execute paper feed roller cleaning

Make sure that the printer is on and then click **OK**.

Paper feed roller cleaning starts.

5. Complete paper feed roller cleaning

After the rollers have stopped, follow the instruction in the message, load three sheets of plain paper into the rear tray, and click **OK**.

Paper will be ejected and feed roller cleaning will be completed.

# Use Your Computer to Print a Nozzle Check Pattern

The nozzle check function allows you to check whether the print head is working properly by printing a nozzle check pattern. Print the pattern if printing becomes faint, or if a specific color fails to print.

The procedure for printing a nozzle check pattern is as follows:



## Nozzle Check

1. Select **Test Print** from the pop-up menu on the [Canon IJ Printer Utility](#)

2. Click the **Nozzle Check** icon

The confirmation message appears.

Click  to display the items that you need to check before printing the nozzle check pattern.

3. Set the paper thickness lever to the right, and load paper in the printer

Load one sheet of A4 size or Letter size plain paper into the rear tray.

4. Print a nozzle check pattern

Make sure that the printer is on and click **Print Check Pattern**.

Printing of the nozzle check pattern begins.

5. Check the print result

When the dialog opens, check the print result. If the print result is normal, click **Quit**.

If the print result is smudged or if there are any unprinted sections, click **Cleaning** to clean the print head.

## Related Topic

- [Cleaning the Print Heads from Your Computer](#)

## Aligning the Print Head

When you perform head position adjustment, errors in the print head adjustment position are corrected and conditions such as color and line streaking are improved.

If the print results appear uneven because of line shifts or other conditions, adjust the position of the print head.

On this printer, you can adjust the print head either [automatically](#) or [manually](#).

# Aligning the Print Head Position from Your Computer

Print head alignment corrects the installation positions of the print head and improves deviated colors and lines.

This printer supports two head alignment methods: automatic head alignment and manual head alignment. Normally, the printer is set for automatic head alignment.

If the printing results of automatic print head alignment are not satisfactory, [perform manual head alignment](#).

The procedure for performing automatic print head alignment is as follows:

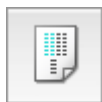

## Print Head Alignment

1. Select **Test Print** from the pop-up menu on the [Canon IJ Printer Utility](#)

2. Click the **Print Head Alignment** icon

A message is displayed.

3. Set the paper thickness lever to the right, and load paper in the printer

Load one sheet of A4 size or Letter size Matte Photo Paper (MP-101) into the rear tray.

### ▶▶▶ Note

- The type of media and number of sheets to be used differ when you select the manual head alignment.

4. Execute head alignment

Make sure that the printer is on and click **Align Print Head**.

Print head alignment starts.

### ▶▶▶ Important

- Do not open the print head cover while printing is in progress.

### ▶▶▶ Note

- Wait until printing ends before performing other operations. Printing takes about 4 minutes to complete.

### ▶▶▶ Note

- After head alignment is completed, you can print and check the current setting. To do so, click the **Print Head Alignment** icon and when the message is displayed, click **Print Alignment Value**.



# Aligning the Print Head Position Manually from Your Computer

Print head alignment corrects the installation positions of the print head and improves deviated colors and lines.

This printer supports two head alignment methods: [automatic head alignment](#) and manual head alignment. Normally, the printer is set for automatic head alignment.

If the printing results of automatic print head alignment are not satisfactory, perform manual head alignment.

The procedure for performing manual print head alignment is as follows:



## Print Head Alignment

1. Select **Custom Settings** from the pop-up menu on the [Canon IJ Printer Utility](#)
2. Switch head alignment to manual  
Check the **Align heads manually** check box.
3. Apply the settings  
Click **Apply** and when the confirmation message appears, click **OK**.
4. Select **Test Print** from the pop-up menu on the Canon IJ Printer Utility
5. Click the **Print Head Alignment** icon  
A message is displayed.
6. Set the paper thickness lever to the right, and load paper in the printer  
Load two sheets of A4 size or Letter size plain paper into the rear tray.
7. Execute head alignment  
Make sure that the printer is on and click **Align Print Head**.  
The first pattern is printed.

### ▶▶▶ Important

- Do not open the print head cover while printing is in progress.

8. Check the printed pattern

Enter the numbers of the patterns with the least noticeable streaks in the associated boxes, and click **OK**.

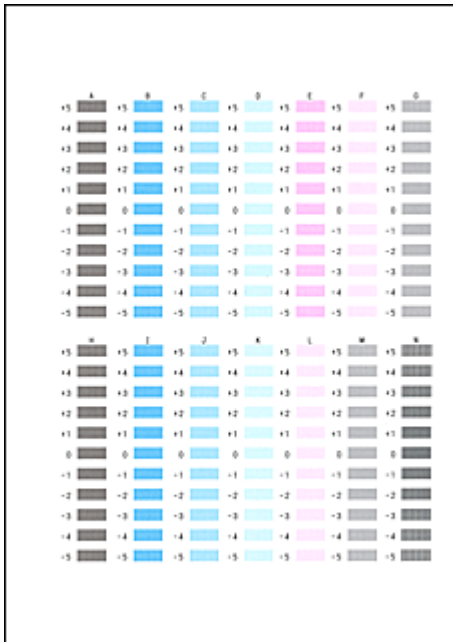

➤➤➤ **Note**

- If it is difficult to pick the best pattern, pick the setting that produces the least noticeable vertical streaks.



(A)



(B)

(A) Least noticeable vertical streaks

(B) Most noticeable vertical streaks

9. Confirm the displayed message and click **OK**

The second pattern is printed.

➤➤➤ **Important**

- Do not open the print head cover while printing is in progress.

10. Check the printed pattern

Enter the numbers of the patterns with the least noticeable stripes in the associated boxes, and click **OK**.

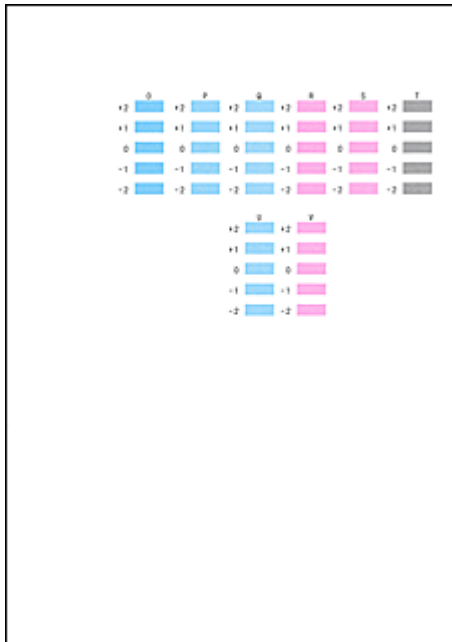

➤➤➤ **Note**

- If it is difficult to pick the best pattern, pick the setting that produces the least noticeable horizontal stripes.



(A)



(B)

(A) Least noticeable horizontal stripes

(B) Most noticeable horizontal stripes

11. Confirm the displayed message and click **OK** or **Cancel**

Click **Cancel** to complete the basic print head alignment.

To run the alignment for correcting problems such as streaks appearing on the print surface, load one sheet of A4 size or Letter size plain paper in the rear tray and click **OK**. The third pattern is printed.

➤➤➤ **Important**

- Do not open the print head cover while printing is in progress.

12. Check the printed pattern

Enter the numbers of the patterns with the least noticeable streaks in the associated boxes, and click **OK**.

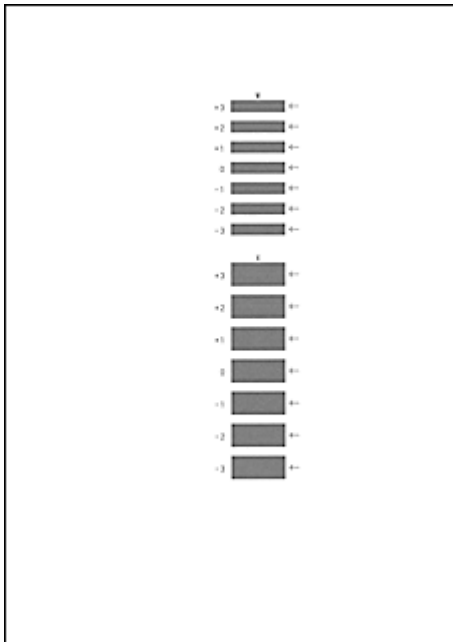

➤➤ **Note**

- If it is difficult to pick the best pattern, pick the setting that produces the least noticeable horizontal streaks.



(A)



(B)

(A) Least noticeable horizontal streaks

(B) Most noticeable horizontal streaks

➤➤ **Note**

- After head alignment is completed, you can print and check the current setting. To do so, click the **Print Head Alignment** icon and when the message is displayed, click **Print Alignment Value**.

## Checking the Current Battery Level

Battery Level Information allows you to check your model's current battery level. The battery level indicator is displayed when the optional battery is being used.

1. Select **Battery Level Information** from the pop-up menu on the [Canon IJ Printer Utility](#)

An illustration of the battery types and their status is displayed.

An icon will be displayed to warn that a battery is running low or a no battery error has occurred.



The battery is running low. After printing ends, charge the battery.



The battery has run out. Connect the AC adapter, or load a charged battery.

### ▶▶ Note

- Click **Update** to display the latest battery level.

## **Cleaning the Printer**

- **Cleaning the Exterior of the Printer**
- **Cleaning the Paper Feed Roller**
- **Cleaning the Inside of the Printer (Bottom Plate Cleaning)**

## Cleaning the Exterior of the Printer

Be sure to use a soft and dry cloth such as eyeglasses cleaning cloth and wipe off dirt on the surface gently. Smooth out wrinkles on the cloth if necessary before cleaning.

### »» Important

- Be sure to turn off the power and unplug the power cord before cleaning the printer.
- Do not use tissue paper, paper towels, rough-textured cloth, or similar materials for cleaning so as not to scratch the surface. Paper tissue powder or fine threads may remain inside the printer and cause problems such as print head blockage and poor printing results.
- Never use volatile liquids such as thinners, benzene, acetone, or any other chemical cleaner to clean the printer, as this may cause a malfunction or damage the surface of the printer.

## Cleaning the Paper Feed Roller

If the paper feed roller is dirty or paper powder is attached to it, paper may not be fed properly.

In this case, perform the paper feed roller cleaning from the computer. Cleaning will wear out the paper feed roller, so perform this only when necessary.

### ■ [Cleaning the Paper Feed Rollers from Your Computer](#)

If the problem is not resolved after cleaning the paper feed roller from the computer, turn off the power, unplug the power cord, then wipe the paper feed roller (A) located on the right side inside the rear tray with a moistened cotton swab or the like while rotating them manually. Do not touch the roller with your fingers. Rotate the roller two or more times.



After cleaning the paper feed roller, turn on the power, then clean the paper feed roller again.

If the problem is not resolved after cleaning the paper feed roller, contact the service center.



## Cleaning the Inside of the Printer (Bottom Plate Cleaning)

Remove stains from the inside of the printer. If the inside of the printer becomes dirty, printed paper may get dirty, so we recommend performing cleaning regularly.

**You need to prepare: two sheets of A4 or Letter-sized plain paper\***

\* Be sure to use a new piece of paper.

1. Make sure that the power is turned on.
2. Load only one sheet of A4 or Letter-sized plain paper in the rear tray.
3. Fold the other sheet of A4 or Letter-sized plain paper in half widthwise, then unfold the paper.
4. Load this sheet of paper on the paper loaded in step 2 with the open side facing you.



5. Set the paper thickness lever to the right.

■ [Loading Paper](#)

6. Hold down the **RESUME/CANCEL** button until the **POWER** lamp flashes five times, then release it immediately.

The paper cleans the inside of the printer and only the paper folded in step 4 is ejected.

Check the folded parts of the ejected paper. If they are smudged with ink, perform Bottom Plate Cleaning again.

### ▶▶▶ Note

- When performing Bottom Plate Cleaning again, be sure to use a new piece of paper.

If the problem is not resolved after performing cleaning again, the protrusions inside the printer may be stained. Wipe off any ink from the protrusions using a cotton swab or the like.

**»» Important**

- Be sure to turn off the power and unplug the power cord before cleaning the printer.



## **Changing the Printer Settings**

- ▶ **Changing Printer Settings from Your Computer**
- ▶ **Changing the Machine Settings Using the Operation Panel**
- ▶ **Initializing the Printer Settings**
- ▶ **Disabling the Wireless LAN Function of the Printer**
- ▶ **Setting the Ink Usage Control**

## **Changing Printer Settings from Your Computer**

- **Checking the Ink Status from Your Computer**
- **Registering a Changed Printing Profile**
- **Setting the Ink Usage Control**
- **Managing the Printer Power**
- **Reducing the Printer Noise**
- **Changing the Printer Operation Mode**

## Checking the Ink Status from Your Computer

You can check the detailed information such as the remaining ink level and the ink tank types of your model.

1. Select **Ink Level Information** from the pop-up menu on the [Canon IJ Printer Utility](#)

An illustration of the ink types and their status is displayed.

If a warning or error related to the remaining ink level occurs, the printer driver displays an icon to let you know.

2. If necessary, click **Ink Details**

You can check the ink-related information.

### ▶▶ Note

- **Ink Details** is displayed when the ink level is low.
- Click  to check which ink tank your model uses.
- Click **Update** to display the current remaining ink level.
- When you receive a notice about the remaining ink level, a mark appears above the ink icon.

For example:



Ink tank is running low. Prepare a new ink tank.

## Registering a Changed Printing Profile

You can name and register the printing profile you made in the [Print Dialog](#). The registered printing profile can be called up from **Presets** to be used. You can also delete the unnecessary printing profile.

The procedure for registering a printing profile is as follows:

### Registering a Printing Profile

1. In the Print dialog, set the necessary items
2. Select **Save Current Settings as Preset... (Save As...)** from the **Presets**

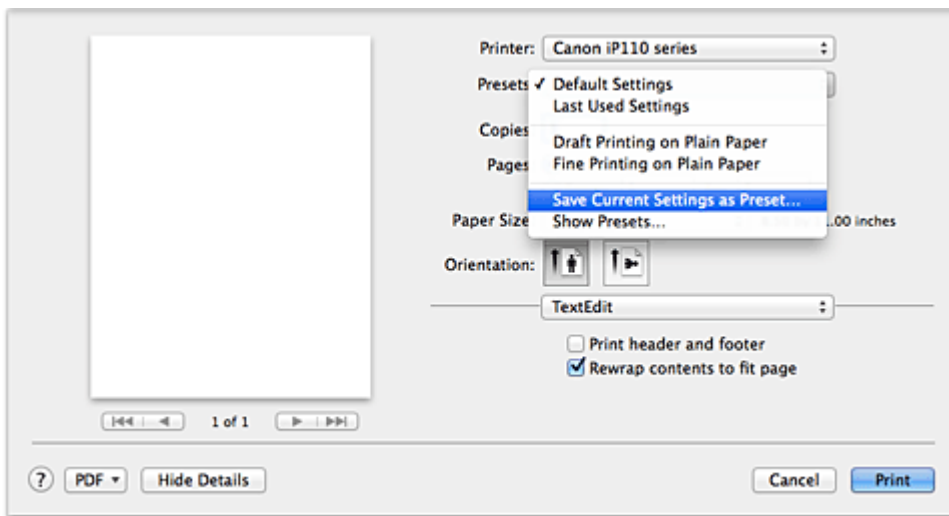

3. Save the settings

In the displayed dialog, enter a name in **Preset Name**, and if necessary, set **Preset Available For**. Then click **OK**.

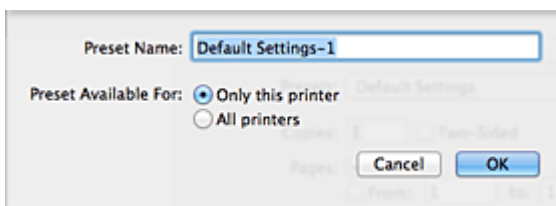

### »»» Important

- There are also print settings that cannot be saved to preset.

## Using Registered Printing Profile

1. On **Presets** in the Print dialog, select the name of printing profile you want to use  
Printing profile in the Print dialog will be updated to the called profile.

## Deleting Unnecessary Printing Profile

### 1. Select the printing profile to be deleted

- If you are using OS X Mavericks v10.9, OS X Mountain Lion v10.8, or OS X Lion v10.7

In the print dialog, select **Show Presets...** in the **Presets** section. Then in the dialog that appears, select the name of the printing profile to be deleted.

- If you are using Mac OS X v10.6.8

On **Presets** in the Print dialog, select the name of printing profile you want to delete.

### 2. Delete the printing profile

- If you are using OS X Mavericks v10.9, OS X Mountain Lion v10.8, or OS X Lion v10.7

Click **Delete**, and click **OK**. The selected printing profiles will be deleted from **Presets**.

- If you are using Mac OS X v10.6.8

On **Presets** in the Print dialog, click **Delete**. The selected printing profiles will be deleted from **Presets**.

# Setting the Ink Usage Control

This function allows you to reduce the amount of black ink used and to produce the black sections with color inks when printing to plain paper.

The procedure for configuring the ink usage control function is as follows:

1. Select **Ink Usage Control** from the pop-up menu on the [Canon IJ Printer Utility](#)
2. If necessary, complete the following settings:

## Save Black Ink

Controls the consumption of black ink during printing. This function allows you to save black ink.

To use this function, select **Plain Paper** for **Media Type** in the **Quality & Media** pop-up menu of the [Print dialog](#). Also, set **Print Quality** to **Standard**, or select **Custom** and set **Quality** to the 2nd level from the right.

## Use Composite Black (Immediate Measure)

Instead of using black ink, the printer combines color inks to synthesize black for printing the black sections.

Use this function only as an immediate and temporary measure, when the black ink runs out and there is no replacement at that time. You should leave this check box unchecked under normal circumstances.

To use this function, select **Plain Paper** for **Media Type** in the **Quality & Media** pop-up menu of the Print dialog. Also, set **Print Quality** to **Standard**, or select **Custom** and set **Quality** to the 2nd or 3rd level from the right.

## ►► Important

- The confirmation message will appear when you execute printing.
- Uncheck this check box after replacing the black ink tank with a new one.

3. Save the settings

Click **Apply**. Click **OK** when the confirmation message appears.

The settings will be enabled hereafter.

## ►► Important

- The print quality may deteriorate when **Ink Usage Control** is used.
- The **Ink Usage Control** function does not work when:
  - A type of paper other than **Plain Paper** is selected from the **Media Type** menu of the **Quality & Media** pop-up menu in the Print dialog.
  - "XXX (borderless)" is selected from the **Paper Size** pop-up menu in the Page Setup dialog.
- **Save Black Ink** and **Use Composite Black (Immediate Measure)** cannot be used at the same time.



# Managing the Printer Power

This function allows you to manage the printer power from the printer driver.

The procedure for managing the printer power is as follows:



## Power Off

The **Power Off** function turns off the printer. When you use this function, you will not be able to turn the printer on from the printer driver.

1. Select **Power Settings** from the pop-up menu on the [Canon IJ Printer Utility](#)
2. Execute power off

Click **Power Off**, and when the confirmation message appears, click **OK**.  
The printer power switches off.



## Auto Power

**Auto Power** allows you to set **Auto Power Off**.

The **Auto Power Off** function automatically turns off the printer when there are no operations from the printer driver or the printer for a specified period of time.

A different time can be set depending on whether the AC adapter is used or the battery is used.

1. Select Power Settings from the pop-up menu on the [Canon IJ Printer Utility](#)
2. Check that the printer is on, and then click **Auto Power**

A dialog appears.

### ▶▶▶ Note

- If the printer is off or if communication between the printer and the computer is disabled, an error message may appear because the computer cannot collect the printer status.

3. If necessary, complete the following setting:

#### Using AC Adapter:

Specify the time from the list. When the AC adapter is used and this time elapses without any operations from the printer driver or the printer, the printer turns off automatically.

#### Using Battery:

Specify the time from the list. When the battery is used and this time elapses without any operations from the printer driver or the printer, the printer turns off automatically.

### ▶▶▶ Important

- **Disable** cannot be specified for **Using Battery**.

4. Apply the settings

The setting is enabled after this. When you want to disable this function, select **Disable** from the list according to the same procedure.

### **»» Important**

- If you connect this printer to a network and use it by using an AC adapter, you can set **Auto Power Off** but the power will not be turned off automatically.

## Reducing the Printer Noise

The silent function allows you to reduce the operating noise of this printer. Select when you wish to reduce the operating noise of the printer at night, etc.

Using this function may lower the print speed.

The procedure for using the quiet mode is as follows:

1. Select **Quiet Settings** from the pop-up menu on the [Canon IJ Printer Utility](#)

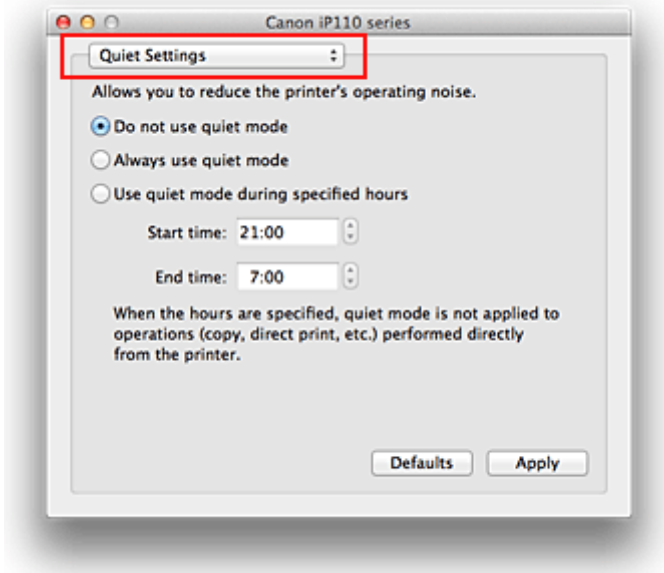

### ►► Note

- If the computer is unable to communicate with the printer, a message may be displayed because the computer cannot access the function information that was set on the printer. If this happens, click **Cancel** to display the most recent settings specified on your computer.

2. Set the quiet mode

If necessary, specify one of the following items:

#### **Do not use quiet mode**

Select this option when you wish to use the printer with volume of normal operating noise.

#### **Always use quiet mode**

Select this option when you wish to reduce the operating noise of the printer.

#### **Use quiet mode during specified hours**

Select this option when you wish to reduce the operating noise of the printer during a specified period of time.

Set the **Start time** and the **End time** of the quiet mode you wish to be activated. If both are set to the same time, the quiet mode will not function.

### ►► Important

- If you specify a time for **Use quiet mode during specified hours**, quiet mode is not applied to operations (direct print, etc.) performed directly from the printer.

3. Apply the settings

Make sure that the printer is on and click **Apply**.  
Click **OK** when the confirmation message appears.

The settings are enabled hereafter.

**»» Note**

- The effects of the quiet mode may be less depending on the print quality settings.

# Changing the Printer Operation Mode

If necessary, switch between various modes of printer operation.

The procedure for configuring **Custom Settings** is as follows:

1. Make sure that the printer is on, and then select **Custom Settings** from the pop-up menu on the [Canon IJ Printer Utility](#)

## ▶▶▶ Note

- If the computer is unable to communicate with the printer, a message may be displayed because the computer cannot access the function information that was set on the printer. If this happens, click **Cancel** to display the most recent settings specified on your computer.

2. If necessary, complete the following settings:

### **Ink Drying Wait Time**

You can set the length of the printer rest time until printing of the next page begins. Moving the slider to the right increases the pause time, and moving the slider to the left decreases the time. If the paper gets stained because the next page is ejected before the ink on the printed page dries, increase the ink drying wait time. Reducing the ink drying wait time speeds up printing.

### **Display Guide Message**

Displays a guide when you perform operations in which the paper setting procedure is complicated.

#### **Hagaki Printing**

Displays the guide message before the printer begins hagaki printing.

To hide the guide messages, select the **Do not show again** check box in the displayed dialog.

To display the guide messages again, display the Canon IJ Printer Utility pop-up menu, select **Custom Settings**, and then check the **Hagaki Printing** check box.

## ▶▶▶ Important

- With OS X Mavericks v10.9, OS X Mountain Lion v10.8, or OS X Lion v10.7, you cannot use **Display Guide Message**. Therefore, if you check the **Do not show again** check box when a guide message is displayed before printing starts, this will stop any more guide messages from being displayed.

### **Align heads manually**

Usually, the **Print Head Alignment** function of **Test Print** on the pop-up menu in the Canon IJ Printer Utility is set to automatic head alignment, but you can change it to manual head alignment. If the printing results of automatic print head alignment are not satisfactory, [perform manual head alignment](#).

Check this check box to perform the manual head alignment. Uncheck this check box to perform the automatic head alignment.

### **Detect the paper width when printing from computer**

When you print from the computer, this function identifies the paper that was loaded into this printer. When the paper width detected by the printer differs from the width of the paper specified in **Paper Size** on the Print dialog, a message is displayed.

To use paper width detection when printing from the computer, select the check box.

## **»» Important**

- When you use a custom page size, correctly set the size of the paper loaded in the printer in the **Custom Paper Sizes** dialog.  
If an error message is displayed even though paper of the same size that was specified is loaded, uncheck the **Detect the paper width when printing from computer** check box.

### 3. Apply the settings

Click **Apply** and when the confirmation message appears, click **OK**.

The printer operates with the modified settings hereafter.

## Changing the Machine Settings Using the Operation Panel

- ▶ [Using the Printer with the Access Point Mode](#)

# Using the Printer with the Access Point Mode

By using the printer as an access point in an environment that does not have wireless LAN router or access point, or by using the printer as an access point temporarily in an environment that has wireless LAN router or access point, you can connect the printer to an external device such as a computer or a smartphone and print from them.

This section describes how to enable the access point mode, the access point name of the printer, and the security setting.

■ [How to enable the Access Point Mode](#)

■ [Printing with the Access Point Mode](#)

■ [How to terminate the Access Point Mode](#)

■ [Setting of the Access Point Mode](#)

## ▶▶▶ Important

- Before using the printer with the access point mode, confirm the usage restrictions then switch the printer to the access point mode.
  - [Restrictions](#)
- If you use the printer with the access point mode for the long time, it is recommended that you change the default access point name and the default password to the combination of numbers and letters with the point of view of security.

## How to enable the Access Point Mode

Enable the access point mode following the procedure below.

1. [Make sure that the printer is turned on.](#)
2. Press and hold the **Wi-Fi** button, then release the button when the **Alarm** lamp flashes 3 times.

When the **POWER** lamp changed from flashing to lit, the access point mode is enabled.

## ▶▶▶ Note

- To confirm the current access point mode setting of the printer, print out the network setting information.
  - [Printing Out Network Setting Information](#)
- You can specify the access point name (SSID) and the security setting optionally.
  - [Setting of the Access Point Mode](#)

## Printing with the Access Point Mode

Print with the access point mode following the procedure below.

1. Connect an external device such as a computer or a smartphone to the printer via wireless LAN.



Perform wireless LAN settings with your external device, then assign the access point name specified for the printer as a destination.

### ▶▶▶ Note

- For details on how to perform wireless LAN settings with an external device, refer to the device's instruction manual.
- When a WPA2-PSK (AES) password is valid on the printer, entering the password is required to connect an external device to the printer via wireless LAN. Enter the password specified for the printer.

2. Start printing from an external device such as a computer or a smartphone.

### ▶▶▶ Note

- For details on how to print from an external device such as a computer or a smartphone via wireless LAN, refer to the device's or application's instruction manual.

## How to terminate the Access Point Mode

In environments that the printer is connected with the computer over the wireless LAN usually, set the printer to the wireless LAN connection when you finish using the printer with the access point mode temporarily.

To enable the wireless LAN mode, press and hold the **Wi-Fi** button, then release the button when the **Alarm** lamp flashes 4 times.

When the **POWER** lamp changed from flashing to lit, the wireless LAN mode is enabled.

### ▶▶▶ Note

- If you do not use the printer with the access point mode or over the wireless LAN:  
The **Wi-Fi** lamp goes off by pressing and holding the **RESUME/CANCEL** button then releasing the button when the **Alarm** lamp flashes 12 times.  
When the **Wi-Fi** lamp goes, the access point mode and the wireless LAN are disabled.

## Setting of the Access Point Mode

The initial value of the access point mode is set as follows.

SSID (access point name)	XXXXXX-iP110series * "XXXXXX" is the last six digits of MAC address of the printer.
Security setting	WPA2-PSK (AES)
Password	XXXXXXXX * The default value in this item varies by the printer.

### ▶▶▶ Note

- To confirm the current access point mode setting of the printer, print out the network setting information.

■ [Printing Out Network Setting Information](#)

- You can change the security setting and the password using IJ Network Tool.

If you change the access point mode setting of the printer, also change the access point setting of the external device such as a computer or a smartphone.

---

# Initializing the Printer Settings

You can initialize the printer settings.

## ▶▶ Important

- When using the printer over wireless LAN, note that initialization erases all network settings on the printer, and printing operation from a computer over network may become impossible. To use the printer over network, perform setup according to the instructions on our website.

Follow the procedure below to initialize the printer settings.

1. [Make sure that the printer is turned on.](#)
2. Press and hold the **RESUME/CANCEL** button then release the button when the **POWER** lamp flashes 15 times.

All the printer settings are initialized. The administrator password specified by IJ Network Tool reverts to the default setting.

## ▶▶ Note

- You cannot initialize the current position of the print head.

## Disabling the Wireless LAN Function of the Printer

Follow the procedure below to disable the wireless LAN.

1. [Make sure that the printer is turned on.](#)
2. Press and hold the **RESUME/CANCEL** button then release the button when the **POWER** lamp flashes 12 times.

The **Wi-Fi** lamp goes off.

### **Note**

- When you enable the wireless LAN, press and hold the **RESUME/CANCEL** button, then release the button when the **POWER** lamp flashes 10 times.

# Setting the Ink Usage Control

The ink usage control function allows you to reduce black ink consumption and to produce the black sections with color inks when printing to plain paper from a computer.

■ [Reducing Black Ink Consumption](#)

■ [Producing the Black Sections with Color Inks](#)

## ▶▶▶ Important

- The print quality may deteriorate if this function is used.

## Reducing Black Ink Consumption

This function allows you to reduce the black ink consumption during printing and to allow longer life of black ink.

## ▶▶▶ Important

- This function is available when the settings below are selected.
  - When **Plain Paper** is selected for **Media Type** on **Quality & Media** in the Print dialog
  - When **Standard** is selected for **Print Quality** on **Quality & Media** in the Print dialog
  - When **Custom** is selected for **Print Quality** on **Quality & Media** in the Print dialog, and the second setting from the right is selected for **Quality**
- This function is not available when **Borderless Printing** is selected.

1. [Make sure that the printer is turned on.](#)
2. [Open the Canon IJ Printer Utility.](#)
3. Select **Ink Usage Control** in the pop-up menu.
4. Select **Save Black Ink**.
5. Click **Apply**.
6. Confirm the message, then click **OK**.

The specified setting will be used during printing.

## Producing the Black Sections with Color Inks

The black part is printed using color inks.

Use this function only as an immediate and temporary measure, when the black ink runs out and there is no replacement at that time. Disable this function under normal circumstances.

## ▶▶▶ Important

- This function is available when the settings below are selected.
  - When **Plain Paper** is selected for **Media Type** on **Quality & Media** in the Print dialog

- When **Standard** is selected for **Print Quality** on **Quality & Media** in the Print dialog
- When **Custom** is selected for **Print Quality** on **Quality & Media** in the Print dialog, and the second or third setting from the right is selected for **Quality**
- This function is not available when **Borderless Printing** is selected.

1. [Make sure that the printer is turned on.](#)
2. [Open the Canon IJ Printer Utility.](#)
3. Select **Ink Usage Control** in the pop-up menu.
4. Select **Use Composite Black (Immediate Measure)**.
5. Click **Apply**.
6. Confirm the message, then click **OK**.

The specified setting will be used during printing.

#### ▶▶▶ Note

- Deselect the check box after replacing the black ink tank with a new one.

#### ▶▶▶ Important

- **Save Black Ink** and **Use Composite Black (Immediate Measure)** cannot be used at the same time.

## Information about Network Connection

- ▶ [Useful Information about Network Connection](#)

## **Useful Information about Network Connection**

- **Default Values Set at Factory (Network)**
- **Connecting the Printer to the Computer Using a USB Cable**
- **When Detecting the Printers Have the Same Name**
- **Connecting to Other Computer with LAN/Changing the Connection Method from USB to LAN**
- **Printing Out Network Setting Information**



## Default Values Set at Factory (Network)

### Default Values of the LAN Connection

Item	The default
Enable/disable LAN	Enable
SSID	BJNPSETUP
Communication mode	Infrastructure
Wireless LAN security	Disable
IPv4 IP address	Auto setup
IPv6 IP address	Auto setup
Set printer name*	XXXXXXXXXXXX
Enable/disable IPv6	Enable
Enable/disable WSD (WSD settings)	Enable
Timeout setting (WSD settings)	1 minute
Enable/disable Bonjour (Bonjour settings)	Enable
Service name (Bonjour settings)	Canon iP110 series
LPR protocol setting	Enable
PictBridge communication	Enable
Wireless LAN DRX	Enable

(\* The default value in this item varies by the printer.)

### Default Values of the Access Point Mode

Item	The default
SSID (access point name) *1	XXXXXX-iP110series
Security setting	WPA2-PSK (AES)
Password *2	XXXXXXXX

\*1 "XXXXXX" is the last six digits of MAC address of the printer.

\*2 The default value in this item varies by the printer.

## Connecting the Printer to the Computer Using a USB Cable

Connect the printer and the computer using a USB cable as the illustration below. The USB port is located on the side of the printer.



## When Detecting the Printers Have the Same Name

When the printer is detected, you may see multiple printers of the same name on the detection result screen. The printer names on the screen are displayed with the MAC address added at the end of the names or displayed as the printer name specified by Bonjour.

Select a printer with checking the MAC address, the printer name specified by Bonjour, or the serial number set to the printer against that on the detection result screen.

### Note

- A serial number may not be displayed on the detection result screen.

To check the MAC address of the printer, print out the network setting information.

 [Printing Out Network Setting Information](#)

## **Connecting to Other Computer with LAN/Changing the Connection Method from USB to LAN**

To add the computer connecting the printer with LAN or to change the connection method between the printer and the computer from USB to LAN, perform setup according to the instructions on our website.

### **Connecting to Other Computer with LAN**

To add the computer connecting the printer with LAN, perform setup according to the instructions on our website.

### **Changing the Connection Method from USB to LAN**

To change the connection method to LAN while you are using the printer with USB connection, perform setup again according to the instructions on our website and select **Change Connection Method**.

# Printing Out Network Setting Information

You can print out the current network settings of the printer.

## ▶▶▶ Important

- This print out contains valuable information about your computer. Handle it with care.

1. [Make sure that the printer is turned on.](#)
2. [Load a sheet of A4 or Letter-sized plain paper.](#)
3. Press and hold the **RESUME/CANCEL** button, then release the button when the **POWER** lamp flashes 6 times.

The printer starts printing the network setting information.

The following information on the printer's network setting is printed out.

Item	Explanations of the item	Setting
Wireless LAN	Wireless LAN	Enable/Disable
Connection	Connection status	Active/Inactive
MAC Address	MAC Address	XX:XX:XX:XX:XX:XX
SSID	SSID	SSID of the wireless LAN/SSID of the access point mode
Password	Password	Password of the access point mode (8 to 10 alphanumeric characters)
Communication Mode	Communication Mode	Infrastructure/Access Point Mode
Channel *1	Channel	XX (1 to 13)
Encryption	Method of the Encryption	none/WEP/TKIP/AES
WEP Key Length	WEP Key Length	Inactive/128/64
Authentication	Method of the Authentication	none/auto/open/shared/WPA-PSK/WPA2-PSK
Signal Strength	Signal Strength	0 to 100 [%]
TCP/IP Version	TCP/IP Version	IPv4 & IPv6/IPv4
IPv4 IP Address	Selected IP Address (IPv4)	XXX.XXX.XXX.XXX
IPv4 Default Gateway	Default Gateway (IPv4)	XXX.XXX.XXX.XXX
Subnet Mask	Subnet Mask	XXX.XXX.XXX.XXX
IPv6 IP Address *2	Selected IP Address (IPv6)	XXXX:XXXX:XXXX:XXXX XXXX:XXXX:XXXX:XXXX
IPv6 Default Gateway *2	Default Gateway (IPv6)	XXXX:XXXX:XXXX:XXXX XXXX:XXXX:XXXX:XXXX

Subnet Prefix Length *2	Subnet Prefix Length	XXX
IPsec *3	IPsec setting	Active
Security Protocol *3	Method of the Security Protocol	ESP/ESP & AH/AH
WPS PIN CODE	WPS PIN code	XXXXXXXXXX
Wireless LAN DRX	Discontinuous reception (wireless LAN)	Enable/Disable
Other Settings	Other settings	-
Printer Name	Printer name	Printer name (Up to 15 alphanumeric characters)
WSD	WSD setting	Enable/Disable
WSD Timeout	Timeout	1/5/10/15/20 [min]
LPR Protocol	LPR protocol setting	Enable/Disable
Bonjour	Bonjour setting	Enable/Disable
Bonjour Service Name	Bonjour service name	Bonjour service name (Up to 52 alphanumeric characters)
PictBridge Commun.	PictBridge Communication	Enable/Disable
DNS Server	Getting DNS Server automatically	Auto/Manual
Primary Server	Primary server address	XXX.XXX.XXX.XXX
Secondary Server	Secondary server address	XXX.XXX.XXX.XXX
Proxy Server	Proxy Server setting	Enable/Disable
Proxy Port	Specifying Proxy Port	1 to 65535
Proxy Address	Proxy Address	XXXXXXXXXXXXXXXXXXXXXXXXXX

("XX" represents alphanumeric characters.)

\*1 Depending on the country or region of purchase, one of the channels from 1 to 11 is printed.

\*2 Only when IPv6 is enabled, the status of the network is printed.

\*3 Only when IPv6 and the IPsec setting are enabled, the status of the network is printed.

## **About Network Communication**

- **Changing and Confirming Network Settings**
- **Appendix for Network Communication**

## **Changing and Confirming Network Settings**

- ▶ **IJ Network Tool**
- ▶ **Canon IJ Network Tool Screen**
- ▶ **Canon IJ Network Tool Menus**
- ▶ **Changing the Settings in the Wireless LAN Sheet**
- ▶ **Changing the WEP Detailed Settings**
- ▶ **Changing the WPA/WPA2 Detailed Settings**
- ▶ **Changing the Settings in the Wired LAN Sheet**
- ▶ **Changing the Settings in the Admin Password Sheet**
- ▶ **Monitoring Wireless Network Status**
- ▶ **Initializing the Network Settings of the Machine**
- ▶ **Viewing the Modified Settings**



# IJ Network Tool

IJ Network Tool is a utility that enables you to display and modify the machine network settings. It is installed when the machine is set up.

## ▶▶▶ Important

- To use the machine over LAN, make sure you have the equipment necessary for the connection type, such as an access point or a LAN cable.
- Do not start up IJ Network Tool while printing.
- Do not print when IJ Network Tool is running.
- If the firewall function of your security software is turned on, a message may appear warning that Canon software is attempting to access the network. If the warning message appears, set the security software to always allow access.

## Starting up IJ Network Tool

1. Select **Applications** from the **Go** menu of Finder, double-click **Canon Utilities > IJ Network Tool**, and double-click the **Canon IJ Network Tool** icon.

Depending on the printer you are using, an administrator password is already specified for the printer at the time of purchase. When you change the network settings, authentication by the administrator password is required.

For details:

■ [About the Administrator Password](#)

For improving security, it is recommended to change the administrator password.

■ [Changing the Settings in the Admin Password Sheet](#)

# Canon IJ Network Tool Screen

This section describes the items displayed on the **Canon IJ Network Tool** screen.

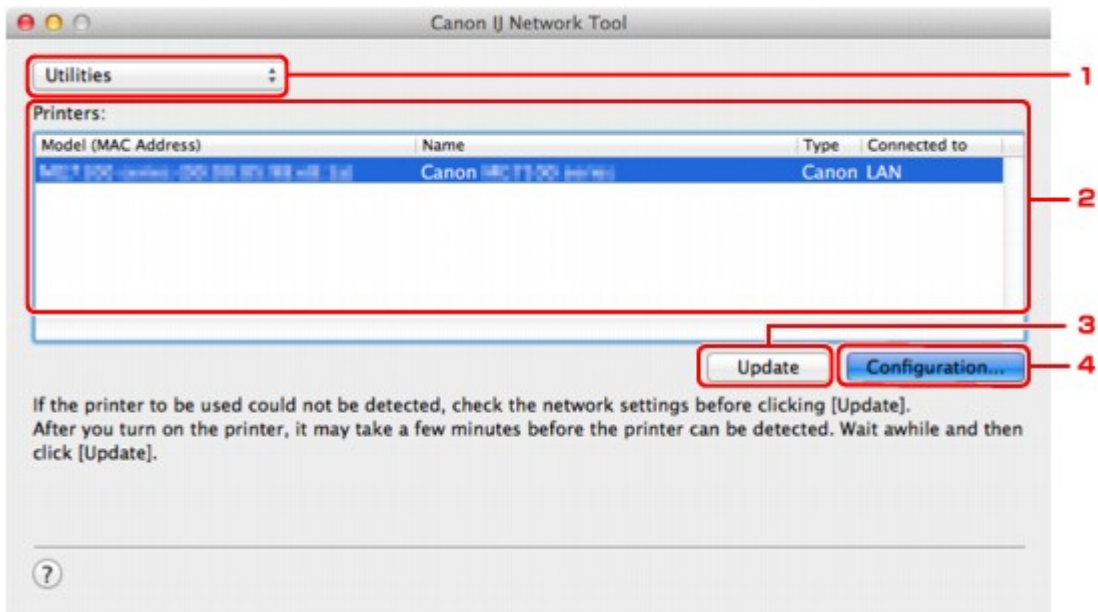

## 1. Utilities

Modifies the settings of the machine.

Select to change the network name (SSID) settings.

### Setup

Sets up the machine.

If you setup the machine from scratch, connect your computer and the machine with a USB cable.

## 2. Printers:

Printer name, type, and connection destination are displayed.

The selected printer can be set up or be modified.

## 3. Update

Performs printer detection again. Click this button if the target printer is not displayed.

### ▶▶▶ Important

- To change the printer's network settings using IJ Network Tool, it must be connected via a LAN.
- If the printer on a network is not detected, make sure that the printer is turned on, then click **Update**. It may take several minutes to detect printers. If the printer is not yet detected, connect the machine and the computer with a USB cable, then click **Update**.
- If the printer is being used from another computer, a screen is displayed informing you of this condition.

### ▶▶▶ Note

- This item has the same function as **Refresh** in the **View** menu.

#### 4. **Configuration...**

Enabled when **Utilities** is selected. Click to display the **Configuration** screen to configure settings of the selected printer.

#### **Note**

- This item has the same function as **Configuration...** in the **Settings** menu.

# Canon IJ Network Tool Menus

This section describes the menus in **Canon IJ Network Tool**.



## 1. Canon IJ Network Tool menu

### About Canon IJ Network Tool

Displays the version of this application.

### Quit Canon IJ Network Tool

Exits IJ Network Tool.

## 2. View menu

### Status

Displays the **Status** screen to confirm the printer connection status and wireless communication status.

In the access point mode, this item is grayed out and you cannot confirm the printer connection status.

### Refresh

Updates and displays the contents of **Printers**: to the latest information.

### ▶▶▶ Important

- To change the printer's network settings using IJ Network Tool, it must be connected via a LAN.
- If the printer on a network is not detected, make sure that the printer is turned on, then select **Refresh**. It may take several minutes to detect printers. If the printer is not yet detected, connect the machine and the computer with a USB cable, then select **Refresh**.
- If the printer is being used from another computer, a screen is displayed informing you of this condition.

### ▶▶▶ Note

- This item has the same function as **Update** in the **Canon IJ Network Tool** screen.

### Network Information

Displays the **Network Information** screen to confirm the network settings of the printer.

## 3. Settings menu

### Configuration...

Displays the **Configuration** screen to configure settings of the selected printer.

### ▶▶▶ Note

- This item has the same function as **Configuration...** in the **Canon IJ Network Tool** screen.

### Maintenance...

Displays the **Maintenance** screen to revert the network settings of the printer to factory default.

### **Set up printer's wireless LAN...**

You can change the access point mode settings. Perform settings following the message on the screen.

If you change the **Encryption Method:** setting and the **Password:** setting, on the **Set up printer's wireless LAN** screen, the changed settings are applied to the printer settings.

#### **▶▶▶ Note**

- You can use this function only when you are using a computer compatible with the wireless LAN.

## **4. Help menu**

### **Instructions**

Displays this guide.

## Changing the Settings in the Wireless LAN Sheet

To change the wireless network settings of the printer, connect the printer and the computer with a USB cable temporarily. If you modify the wireless network settings of the computer over wireless connection without USB connection, your computer may not be able to communicate with the machine after modifying the settings.

### ▶▶▶ Note

- This screen is not available depending on the printer you are using.
- Activate the wireless LAN setting of the printer to change the settings in the **Wireless LAN** sheet.

1. [Start up IJ Network Tool.](#)

2. Select the printer in **Printers:**.

When the printer is connected to the computer with a USB cable temporarily, select the printer with **USB** appearing in the **Connected to** column.

3. Click the **Configuration...** button.

4. Click the **Wireless LAN** button.

5. Change the settings or confirm.

Click **OK** after changing configuration. A screen is displayed asking you for confirmation before the settings are sent to the printer. If you click **OK**, the settings are sent to the printer and the **Transmitted Settings** screen is displayed.

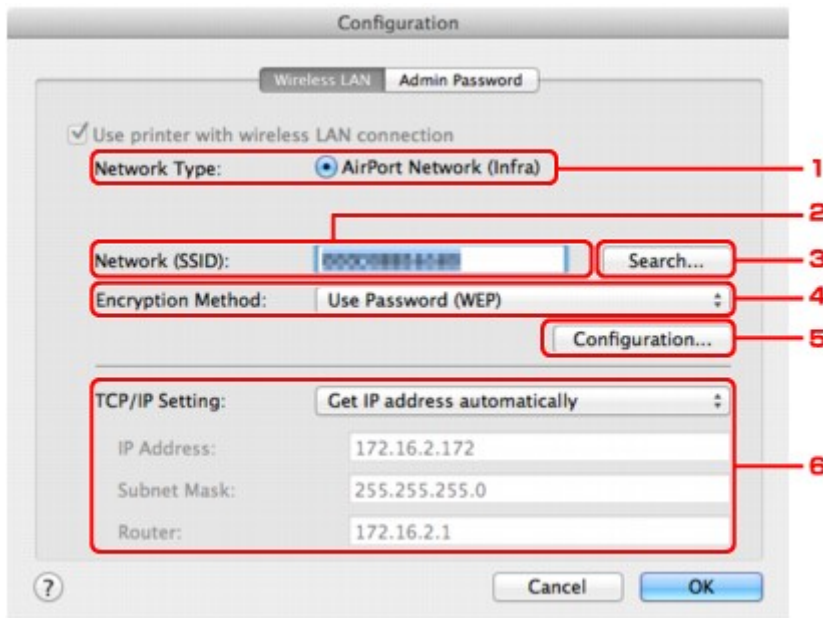

#### 1. Network Type:

Displays the wireless LAN mode currently selected.

#### **AirPort Network (Infra)**

Connects the printer to the wireless LAN with an access point.

## Access point mode

Connects external wireless communication devices (e.g. computers, smartphones, or tablets) to the printer using it as an access point.

### ▶▶▶ Note

- When **Access point mode** is displayed on **Network Type:**, you cannot change the settings on the **Wireless LAN** sheet or the **Admin Password** sheet.
  - You can perform setting from **Set up printer's wireless LAN...** on the **Settings** menu when you use the printer with the access point mode.
- Depending on the printer you are using, you can change the settings using the operation panel.

## 2. Network (SSID):

The network name (SSID) of the wireless LAN currently used is displayed.

In the access point mode, the access point name (SSID) of the printer is displayed.

### ▶▶▶ Note

- Enter the same SSID that the access point is configured to use. The SSID is case-sensitive.

## 3. Search...

The **Access Points** screen is displayed to select an access point to connect to.

■ [Access Points Screen](#)

### ▶▶▶ Note

- When IJ Network Tool runs over a LAN, the button is grayed out and cannot be selected. Connect the printer and the computer with a USB cable temporarily to change the settings.

## 4. Encryption Method:

Select the encryption method used over the wireless LAN.

### ▶▶▶ Important

- If all encryption types of the access point, printer, or computer do not match, the printer cannot communicate with the computer. If the printer cannot communicate with the computer after the encryption type of the printer was switched, make sure that encryption types for the computer and the access point match that set to the printer.
- If you connect to a network that is not protected with security measures, there is a risk of disclosing data such as your personal information to a third party.

### Do Not Use

Select to disable encryption.

### Use Password (WEP)

Transmission is encrypted using a WEP key you specified.

If a network password (WEP) has not been set, the **WEP Details** screen is displayed automatically. To change WEP settings set before, click **Configuration...** to display the screen.

■ [Changing the WEP Detailed Settings](#)

### Use WPA/WPA2

Transmission is encrypted using a network key you specified.

The security has been strengthened more than WEP.

If a network key has not been set, the **Authentication Type Confirmation** screen is displayed automatically. To change network key settings before, click **Configuration...** to display the **WPA/WPA2 Details** screen.

■ [Changing the WPA/WPA2 Detailed Settings](#)

## 5. Configuration...

The detailed settings screen is displayed. The network password (WEP) or the WPA/WPA2 key selected in **Encryption Method**: can be confirmed and changed.

**For details on WEP setting:**

■ [Changing the WEP Detailed Settings](#)

**For details on WPA/WPA2 setting:**

■ [Changing the WPA/WPA2 Detailed Settings](#)

## 6. TCP/IP Setting:

Sets the IP address of the printer to be used over the LAN. Specify a value appropriate for your network environment.

### Get IP address automatically

Select this option to use an IP address automatically assigned by a DHCP server. DHCP server functionality must be enabled on your wireless LAN router or access point.

### Use following IP address

Select this option if no DHCP server functionality is available in your setup where you use the printer, or you want to use a particular IP address or a fixed IP address.

## • Access Points Screen

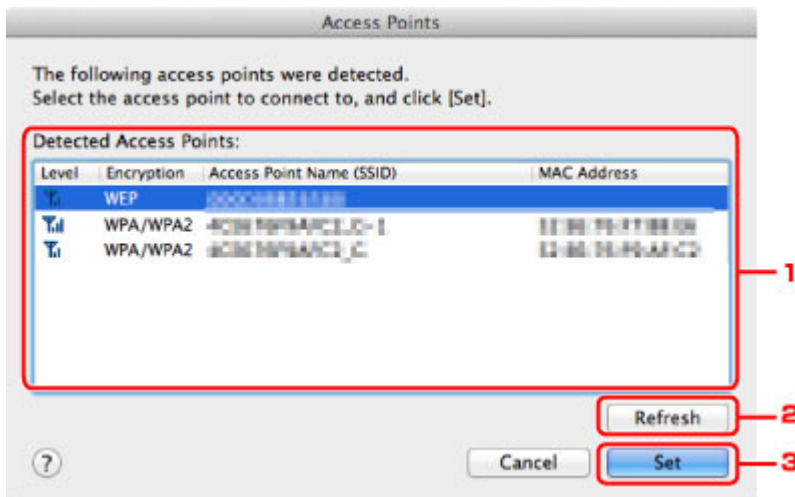

### 1. Detected Access Points:

The signal strength from the access point, encryption type, name of access point, and the radio channel can be confirmed.

### ►►► Important

- If you connect to a network that is not protected with security measures, there is a risk of disclosing data such as your personal information to a third party.



## »» Note

- Signal strength is displayed as follows.

 : Good

 : Fair

 : Poor

- Type of encryption is displayed as follows.

Blank: No encryption

**WEP**: WEP is set

**WPA/WPA2**: WPA/WPA2 is set

## 2. Refresh

Click to update the list of access points when your target access point is not detected.

If the target access point is set to a closed network (the stealth mode), click **Cancel** to return to the previous screen and enter the network name (SSID) in **Network (SSID)**.

## »» Note

- Make sure that the access point is turned on.

## 3. Set

Click to set the network name (SSID) in **Network (SSID)**: on the **Wireless LAN** sheet.

## »» Note

- The **WEP Details** screen or the **WPA/WPA2 Details** screen appears if the selected access point is encrypted. In this case, configure the details to use the same encryption settings set to the access point.
- Access points that cannot be used by this machine (including those configured to use different encryption methods) are displayed grayed out and cannot be configured.

# Changing the WEP Detailed Settings

## ▶▶▶ Note

- This screen is not available depending on the printer you are using.

To change the wireless network settings of the printer, connect the printer and the computer with a USB cable temporarily. If you modify the wireless network settings of the computer over wireless connection without USB connection, your computer may not be able to communicate with the machine after modifying the settings.

1. [Start up IJ Network Tool.](#)

2. Select the printer in **Printers:**.

When the printer is connected to the computer with a USB cable temporarily, select the printer with **USB** appearing in the **Connected to** column.

3. Click the **Configuration...** button.

4. Click the **Wireless LAN** button.

5. Select **Use Password (WEP)** in **Encryption Method:** and click **Configuration....**

The **WEP Details** screen is displayed.

6. Change the settings or confirm.

When changing the password (WEP key), the same change must be made to the password (WEP key) of the access point.

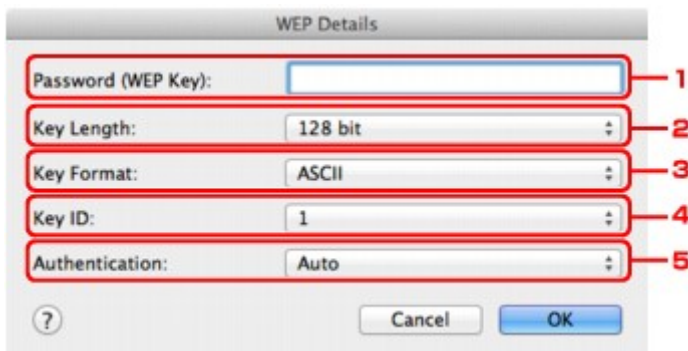

### 1. Password (WEP Key):

Enter the same key as the one set to the access point.

The number of characters and character type that can be entered differ depending on the combination of the key length and key format.

		Key Length	
		64 bit	128 bit
Key Format	ASCII	5 characters	13 characters

	Hexadecimal ( <b>Hex</b> )	10 digits	26 digits
--	----------------------------	-----------	-----------

2. **Key Length:**

Select either **64 bit** or **128 bit**.

3. **Key Format:**

Select either **ASCII** or **Hex**.

4. **Key ID:**

Select the Key ID (index) set to the access point.

**»» Note**

- When the printer is connected to an AirPort Base Station via a LAN:

When the printer is connected to an AirPort Base Station via a LAN, confirm the settings in **Wireless Security** of **AirPort Utility**.

- Select **64 bit** if **WEP 40 bit** is selected for the key length in the AirPort Base Station.
- Select **1** for **Key ID**. Otherwise your computer will not be able to communicate with the printer via the access point.

5. **Authentication:**

Select the authentication method to authenticate the printer's access to the access point.

Normally, select **Auto**. If you want to specify the method manually, select **Open System** or **Shared Key** according to the setting of the access point.

7. Click **OK**.

**»» Important**

- If the printer cannot communicate with the computer after the encryption type of the printer was switched, make sure that encryption types for the computer and the access point match that set to the printer.

# Changing the WPA/WPA2 Detailed Settings

## ▶▶▶ Note

- This screen is not available depending on the printer you are using.

To change the wireless network settings of the printer, connect the printer and the computer with a USB cable temporarily. If you modify the wireless network settings of the computer over wireless connection without USB connection, your computer may not be able to communicate with the machine after modifying the settings.

The example screenshots in this section refer to the WPA detailed settings.

1. [Start up IJ Network Tool.](#)

2. Select the printer in **Printers:**.

When the printer is connected to the computer with a USB cable temporarily, select the printer with **USB** appearing in the **Connected to** column.

3. Click the **Configuration...** button.

4. Click the **Wireless LAN** button.

5. Select **Use WPA/WPA2** in **Encryption Method:** and click **Configuration....**

6. Enter the passphrase, then click **OK**.

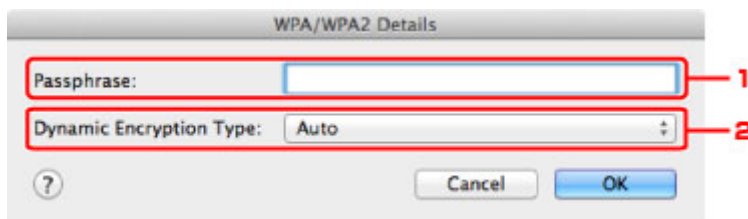

1. **Passphrase:**

Enter the passphrase set to the access point. The passphrase should be a string of 8 to 63 alphanumeric characters or a 64-digit hexadecimal value.

If you do not know the access point passphrase, refer to the instruction manual provided with the access point or contact its manufacturer.

2. **Dynamic Encryption Type:**

The dynamic encryption method is selected from either TKIP (basic encryption) or AES (secure encryption) automatically.

## ▶▶▶ Important

- If **Auto** is not displayed on **Dynamic Encryption Type:**, select either **TKIP(Basic Encryption)** or **AES(Secure Encryption)**.

- If the printer cannot communicate with the computer after the encryption type of the printer was switched, make sure that encryption types for the computer and the access point match that set to the printer.

---

**▶▶ Note**

- This machine supports WPA/WPA2-PSK (WPA/WPA2-Personal) and WPA2-PSK (WPA2-Personal).
-

# Changing the Settings in the Wired LAN Sheet

## ▶▶▶ Note

- This screen is not available depending on the printer you are using.
- Activate the wired LAN setting of the printer to change the settings in the **Wired LAN** sheet.

1. [Start up IJ Network Tool.](#)
2. Select the printer in **Printers:**.
3. Click the **Configuration...** button.
4. Click the **Wired LAN** button.
5. Change the settings or confirm.

Click **OK** after changing configuration. A screen is displayed asking you for confirmation before the settings are sent to the printer. If you click **OK**, the settings are sent to the printer and the **Transmitted Settings** screen is displayed.

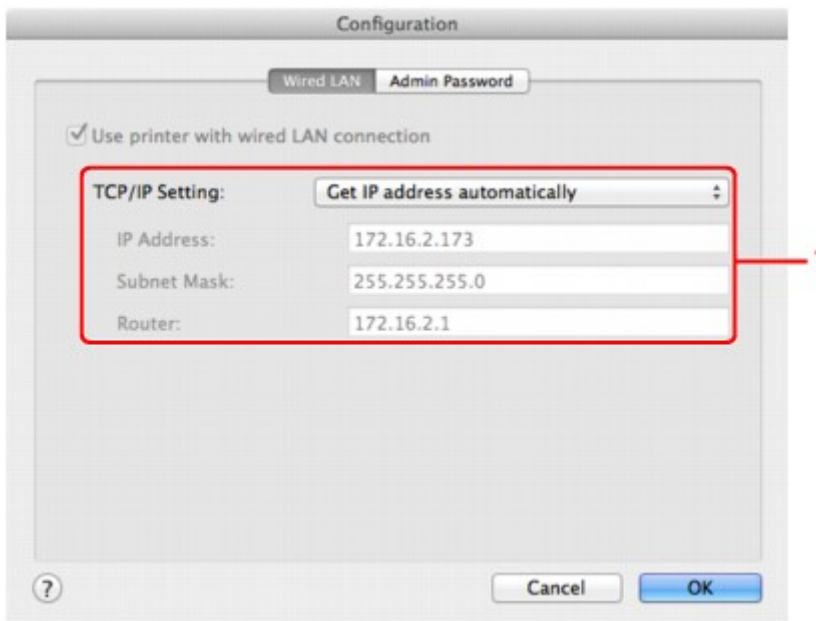

### 1. TCP/IP Setting:

Sets the IP address of the printer to be used over the LAN. Specify a value appropriate for your network environment.

#### **Get IP address automatically**

Select this option to use an IP address automatically assigned by a DHCP server. DHCP server functionality must be enabled on your router.

#### **Use following IP address**

Select this option if no DHCP server functionality is available in your setup where you use the printer, or you want to use a particular IP address or a fixed IP address.

# Changing the Settings in the Admin Password Sheet

## »» Note

- You cannot change the settings when using the access point mode.

1. [Start up IJ Network Tool.](#)
2. Select the printer in **Printers:**.
3. Click the **Configuration...** button.
4. Click the **Admin Password** button.  
The **Admin Password** sheet is displayed.
5. Change the settings or confirm.

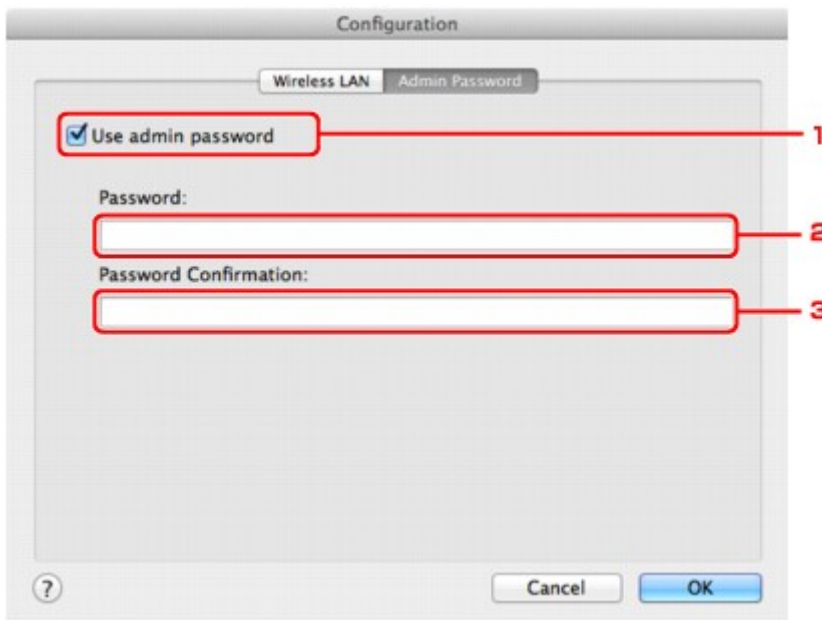

### 1. Use admin password

Set an administrator password with privileges to set up and change detailed options. To use this feature, select this check box and enter a password.

### »» Important

- The password should consist of alphanumeric characters and be no longer than 32 characters. The password is case-sensitive. Do not forget the password you set.

### 2. Password:

Enter the password to set.

### 3. Password Confirmation:

Enter the password again for confirmation.

6. Click **OK**.

A screen is displayed asking you for confirmation before the settings are sent to the printer. If you click **OK**, the settings are sent to the printer and the **Transmitted Settings** screen is displayed.

## Enter Password Screen

The following screen is displayed if an administrator password is set to the printer.



- **Admin Password**

Enter the administrator password that was set. For security purposes, your password is not displayed as you type it.

### »» Important

- If you forget the administrator password you specified, initialize the printer to revert the password to the default setting.

- **OK**

Click this item after you enter the administrator password.

- **Cancel**

This item returns you to list of detected printers. If you do not enter the correct administrator password, you cannot operate the printer.



# Monitoring Wireless Network Status

## ▶▶▶ Note

- This screen is not available depending on the printer you are using.
- When using the machine over the wired LAN, you cannot monitor network status.

1. [Start up IJ Network Tool.](#)
2. Select the printer in **Printers:**.
3. Select **Status** from the **View** menu.

The **Status** screen is displayed and you can check the printer status and connection performance.

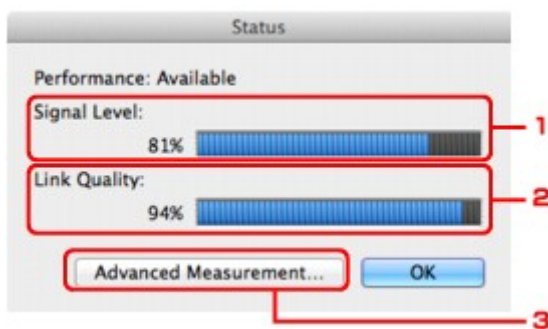

### 1. **Signal Level:**

Indicates the strength of the signal received by the printer, ranging from 0% to 100%.

### 2. **Link Quality:**

Indicates the signal quality excluding the noise while communicating, ranging from 0% to 100%.

## ▶▶▶ Important

- If the indicated value is low, move your printer closer to the wireless network device.

### 3. **Advanced Measurement...**

Click to examine the connection performance between the printer and the access point. Follow the instructions on the screen to start measuring and display the status. Measurement takes a few minutes.

When  is displayed in **Connection performance between the printer and the access point:**, the printer can communicate with the access point. Otherwise, refer to displayed comments and Help for improving the status of communication link, and click **Remeasurement**.

- Check that the printer and the access point are located within the wireless connectivity range with no obstacles between them.

- Check if the distance between the printer and the access point is not too far.

If they are too far, move them closer together (within 164 ft./50 m).

- Check that there is no barrier or obstacle between the printer and the access point.

In general, connection performance decreases for communications through walls or between different floors. Adjust the locations to avoid such situations.

- Check that there are no sources of radio interference near the printer and the access point.

The wireless connection may use the same frequency band as microwave ovens and other sources of radio interference. Try to keep the printer and the access point away from such sources.

- Check if the radio channel of the access point is close to that of other access points nearby.

If the radio channel of the access point is close to that of other access points nearby, the connection performance may become unstable. Be sure to use a radio channel that does not interfere with other access points.

- Check that the printer and the access point face each other.

Connection performance may depend on the orientations of the wireless devices. Replace the access point and the printer in another direction to achieve the best performance.

- Check whether other computers are not accessing the printer.

If  appears in the result of the measurement, check whether other computers are not accessing the printer.

If  still appears even if you have tried the above, finish the measurement, then restart the IJ Network Tool to start over the measurement.

#### **Note**

- If any messages appear on **Overall Network Performance:**, move the machine and access point as instructed to improve the performance.

# Initializing the Network Settings of the Machine

## ▶▶▶ Important

- Note that initialization erases all network settings on the machine, and printing or scanning operation from a computer over network may become impossible. To use the machine over network, perform setup according to the instructions on our website.

1. [Start up IJ Network Tool.](#)
2. Select the printer in **Printers:**.
3. Select **Maintenance...** from the **Settings** menu.

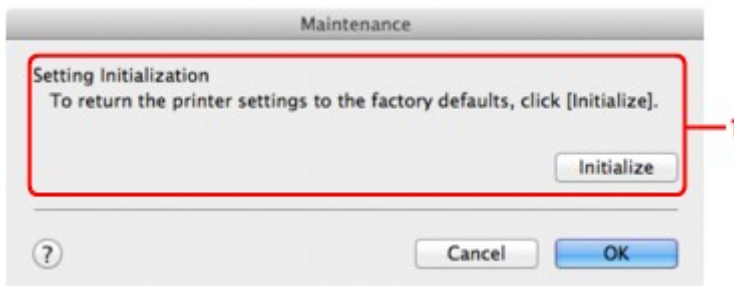

### 1. Setting Initialization

#### Initialize

Reverts all the network settings of the printer to factory default.

4. Click **Initialize**.

The **Setting Initialization** screen is displayed.

Click **OK** to initialize the network settings of the printer. Do not turn off the printer during initialization.

Click **OK** when initialization is complete.

Performing initialization when connected over wireless LAN will break the connection, so perform setup according to the instructions on our website.

## ▶▶▶ Note

- You can change the network settings of the printer using IJ Network Tool with USB connection after initializing the LAN settings. To change the network settings using Canon IJ Network Tool, activate wireless LAN in advance.

## Viewing the Modified Settings

The **Confirmation** screen is displayed when you modified the printer settings on the **Configuration** screen. When you click **OK** on the **Confirmation** screen, the following screen is displayed for confirming the modified settings.

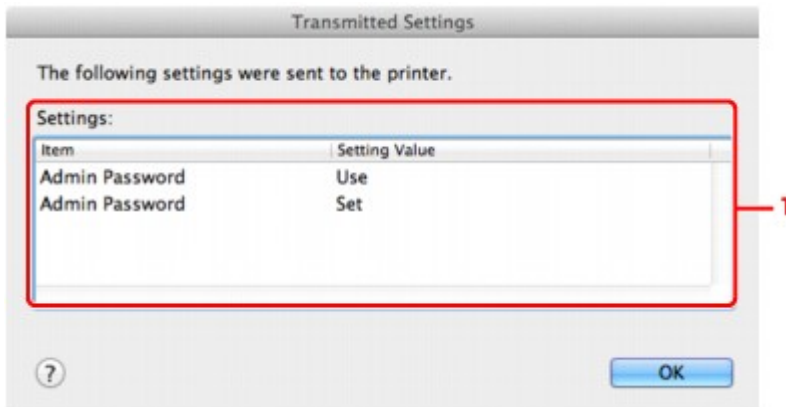

### 1. Settings:

A list of changes made in the **Configuration** screen is displayed.

## **Appendix for Network Communication**

- ▶ **Using the Card Slot over a Network**
- ▶ **About Technical Terms**
- ▶ **Restrictions**

# Using the Card Slot over a Network

## ▶▶▶ Note

- This screen is not available depending on the printer you are using.

## ■ [Mounting the Card Slot as the Network Drive](#)

## ■ [Restrictions on Card Slot Use over a Network](#)

### Mounting the Card Slot as the Network Drive

The card slot must be mounted to use it over a network.

To mount the card slot as the network drive, follow the procedure below.

1. Insert a memory card into the card slot of the machine.
2. Check the current printer name.  
You can check the current printer name on the LCD of the printer.
3. On Finder, click the **Go** menu and **Connect to Server**.
4. Input "smb://xxxxxxxxxx/canon\_memory/", then click **Connect**.

For example, if the current printer name is "123ABC000000", then input "smb://123ABC000000/canon\_memory/".

5. Make sure that the card slot is mounted.

When the card slot is mounted, the following icon appears on the desktop or in the **Computer** window on the **Go** menu of Finder.



## ▶▶▶ Note

- The authentication screen may appear. If it appears, you do not need to input the password.
- If you cannot mount the card slot with the method above, input the IP address of the machine instead of the current printer name, and try again. For example, "smb://192.168.1.1/canon\_memory/". If you mount the card slot with the IP address, you have to remount it whenever the machine's IP address changes.

### Restrictions on Card Slot Use over a Network

- You cannot write data to a memory card in the card slot over a network. You can only read data from a memory card.

- The card slot can be shared by multiple computers, if the machine is connected to a network. Multiple computers can read files from a memory card in the card slot at the same time.
- If your computer joins a domain, the card slot may not be mounted as the network drive.
- If you use the memory card stored the large size files or many files, a large amount of card access may be generated. In this case, the operation in the memory card may be impossible or slow. Operate after the **Access** lamp of the machine is lit.

- When you access the network drive for the card slot over the network, file names consisting of eight or less lowercase letters (not including its extension) may be shown in uppercase.

For example, a file name such as "abcdefg.doc" will be "ABCDEFGG.DOC", while a name such as "AbcdeFG.doc" will appear the same.

The file is not actually renamed, but merely appears to be changed.

- Disable the function to write files to a memory card from a computer to read files from a memory card over a network.

# About Technical Terms

In this section, technical terms used in the manual are explained.

[A](#)

[B](#)

[C](#)

[D](#)

[E](#)

[F](#)

[G](#)

[H](#)

[I](#)

[J](#)

[K](#)

[L](#)

[M](#)

[N](#)

[O](#)

[P](#)

## A

- **Access Point**

A wireless transceiver or base station that receives information from wireless clients/the machine and rebroadcasts it. Required in an infrastructure network.

- **Access point mode**

The machine is used as an access point to connect external wireless communication devices (e.g. computers, smartphones, or tablets) in an environment where no access point or wireless LAN router is available. You can connect up to 5 devices to the machine using the access point mode.

- **Ad-hoc**

Client computer and machine setting where wireless communication occurs on a peer-to-peer basis, i.e., all clients in with the same SSID/network name communicate directly with each other. No access point is required. This machine does not support ad-hoc communication.

- **Admin Password**

Administrator password in IJ Network Tool to restrict access to network users. It must be entered to access the printer and change printer settings.

- **AES**

An encryption method. It is optional for WPA/WPA2. Strong cryptographic algorithm adopted within U.S. government organizations for information processing.



- **AirPort Network (Infra)**

Client computer and machine setup where all wireless communications pass through an access point.

- **Authentication Method**

The method that an access point uses to authenticate a printer through a wireless LAN. The methods are agreeable each other.

When using WEP as an encryption method, the authentication method is able to fix to **Open System** or **Shared Key**.

For WPA/WPA2, authentication method is PSK.

- **Auto**

The printer automatically changes its authentication method to match the access point.

- **Open System**

In this authentication method, the communication partner is authenticated without using WEP key even if **Use Password (WEP)** is selected.

- **Shared Key**

In this authentication method, the communication partner is authenticated using the WEP key that was set for encryption.

## **B**

- **Bonjour**

A service built into Mac OS X operating system to detect the connectable devices on a network automatically.

## **C**

- **Channel**

Frequency channel for wireless communication. In the infrastructure mode, the channel is automatically adjusted to match that set to the access point. This machine supports channels 1 to 13. (Channels 12 and 13 are not supported depending on the country or region of purchase.) Note that the number of channels that can be used for your wireless LAN varies depending on the region or country.

## **D**

- **DHCP server functionality**

The router or the access point assigns an IP address automatically whenever the printer or the personal computer on a network starts up.

- **DNS server**

A server that converts device names into IP addresses. When specifying IP addresses manually, specify the addresses of both a primary and a secondary server.

## F

- **Firewall**

It is a system that prevents an unlawful computer access in the network. To prevent, you can use the firewall function of a broadband router, the security software installed in the computer, or operation system for computer.

## I

- **IEEE 802.11b**

International standard for wireless LAN using the 2.4 GHz frequency range with a throughput of up to 11 Mbps.

- **IEEE 802.11g**

International standard for wireless LAN using the 2.4 GHz frequency range with a throughput of up to 54 Mbps. Compatible with 802.11b.

- **IEEE 802.11n**

International standard for wireless LAN using the 2.4 GHz and 5 GHz frequency ranges. Even when using two or more antennas simultaneously or obtaining a bigger transfer rate than before by using multiple communication channels at the same time, the transmission speed may be influenced by the connected apparatus.

At the maximum transfer rate of 600 Mbps, it is possible to communicate with multiple computer terminals within a dozen or so metre radius.

Compatible with 802.11b and 802.11g.

- **IP Address**

A unique number with four parts separated by dots. Every network device that is connected to the Internet has an IP address. Example: 192.168.0.1

An IP address is usually assigned by an access point or a DHCP server of the router automatically.

- **IPv4/IPv6**

They are internetwork-layer protocol used on the internet. IPv4 uses 32-bit addresses and IPv6 uses 128-bit addresses.

## K

- **Key Format**

Select either **ASCII** or **Hex** as the Password (WEP) key format. The character that can be used for the WEP key differs depending on the selected key formats.

- ASCII

Specify with a 5 or 13-character string that can include alphanumeric and underscore "\_" characters. It is case-sensitive.

- Hex

Specify a 10-digit or 26-digit string that can contain hexadecimal (0 to 9, A to F, and a to f).

- **Key Length**

Length of the WEP key. Select either 64 bits or 128 bits. Longer key length allows you to set a more complex WEP key.

## L

- **Link Quality**

The status of connection between the access point and the printer excluding noise (interference) is indicated with a value from 0 to 100%.

- **LPR**

A platform-independent printing protocol used in TCP/IP networks. It is not supported bidirectional communication.

## M

- **MAC Address (AirPort ID)**

Also known as the physical address. A unique and permanent hardware identifier that is assigned to network devices by its manufacturer. MAC addresses are 48 bits long and are written as a hexadecimal number separated by colons, i.e., 11:22:33:44:55:66.

## N

- **Network (SSID)**

Unique label for wireless LAN. It is often represented such as a network name or a access point name.

SSID distinguishes one wireless LAN from another to prevent interference.

The printer and all clients on a wireless LAN must use the same SSID in order to communicate with each other. The SSID can be up to 32 characters long, and is made up of alphanumeric characters. The SSID may also be referred to by its network name.

## P

- **Password (WEP)/Password (WEP Key)**

An encryption method employed by IEEE 802.11. Shared security key used to encrypt and decrypt data sent over wireless networks. This printer supports key length of 64 bits or 128 bits, key format of ASCII code or Hexadecimal, and key number of 1 to 4.

- **Performance**

Indicates the status on whether the printer can be used.

- **Proxy server**

A server that links a LAN-connected computer to the Internet. When using a proxy server, specify the address and the port number of the proxy server.

- **PSK**

An encryption method employed by WPA/WPA2.

## R

- **Router**

A relay device to connect to another network.

## S

- **Signal Level**

The strength of the signal received by the printer from the access point is indicated with a value from 0 to 100%.

- **SSID**

Unique label for wireless LAN. It is often represented such as a network name or an access point name.

SSID distinguishes one wireless LAN from another to prevent interference.

The printer and all clients on a wireless LAN must use the same SSID in order to communicate with each other. The SSID can be up to 32 characters long, and is made up of alphanumeric characters. The SSID may also be referred to by its network name.

- **Stealth**

In the stealth mode, an access point hides itself by not broadcasting its SSID. The client must specify the SSID set to the access point to detect it.

The stealth mode is called a "closed network".

- **Subnet Mask Address**

IP address has two components, the network address and the host address. Subnet Mask used to calculate the Subnet Mask address from the IP address. A Subnet Mask is usually assigned by an access point or a DHCP server of the router automatically.

Example:

IP Address: 192.168.127.123

Subnet Mask: 255.255.255.0

Subnet Mask Address: 192.168.127.0

## T

- **TCP/IP**

Suite of communications protocols used to connect hosts on the Internet or the LAN. This protocol allows different terminals to communicate with each other.

- **TKIP**

An encryption protocol employed by WPA/WPA2.

## U

- **USB**

Serial interface designed to enable you to "hot-swap" devices, i.e., by plugging and unplugging them without turning off the power.

## W

- **WEP/WEP Key**

An encryption method employed by IEEE 802.11. Shared security key used to encrypt and decrypt data sent over wireless networks. This printer supports key length of 64 bits or 128 bits, key format of ASCII code or Hexadecimal, and key number of 1 to 4.

- **Wi-Fi**

International association that certifies interoperability of wireless LAN products based on the IEEE 802.11 specification.

This machine is a Wi-Fi authorized product.

- **Wireless LAN**

A network that, instead of being connected by physical wires, is connected by a wireless technology, such as Wi-Fi.

- **WPA**

Security framework announced by the Wi-Fi Alliance in October 2002. The security has been strengthened more than WEP.

- Authentication

WPA defines the following authentication methods: WPA Personal that can be used without an authentication server, plus WPA Enterprise that do require an authentication server.

This machine supports WPA Personal.

- Passphrase

This encrypted key is used to perform WPA Personal authentication.

The passphrase should be a string of 8 to 63 alphanumeric characters or a 64-digit hexadecimal value.

- **WPA2**

Security framework released by the Wi-Fi Alliance in September 2004 as a later version of WPA. Provides a stronger encryption mechanism through Advanced Encryption Standard (AES).

- Authentication

WPA2 defines the following authentication methods: WPA2 Personal that can be used without an authentication server, plus WPA2 Enterprise that do require an authentication server.

This machine supports WPA2 Personal.

- Passphrase

This encrypted key is used to perform WPA2 Personal authentication.

The passphrase should be a string of 8 to 63 alphanumeric characters or a 64-digit hexadecimal value.

- **WPS (Wi-Fi Protected Setup)**

WPS is a standard for easy and secure establishment of a wireless network.

There are 2 primary methods used in the Wi-Fi Protected Setup:

PIN entry: a mandatory method of setup for all WPS certified devices

Push button configuration (PBC): an actual push button on the hardware or through a simulated push button in the software.

## **Restrictions**

If you use a printer over the wireless LAN, the printer may recognize nearby wireless systems, you should set a network key (WEP or WPA/WPA2) to the access point to encrypt wireless transmission. Wireless communication with a product that does not comply with the Wi-Fi standard cannot be guaranteed.

Connecting with too many computers may affect the printer performance, such as printing speed.

## **Tips for Ensuring Optimal Printing Quality**

- ▶ **Useful Information about Ink**
- ▶ **Key Points to Successful Printing**
- ▶ **Be Sure to Make Paper Settings after Loading Paper**
- ▶ **Canceling a Print Job**
- ▶ **Printer Handling Precautions**
- ▶ **Key to Enjoying Consistent Printing Quality**
- ▶ **Precautions for Safe Transport of the Printer**



## Useful Information about Ink

### How is ink used for various purposes other than printing?

Ink may be used for purposes other than printing. Ink is not only used for printing, but also for cleaning the print head to maintain the optimal printing quality.

The printer has the function to automatically clean the ink jet nozzles to prevent clogging. In the cleaning procedure, ink is pumped out from the nozzles. Used ink for nozzle cleaning is limited to a small amount.

### Does black-and-white printing use color ink?

Black-and-white printing may use ink other than black ink depending on the type of printing paper or the settings of the printer driver. So, color ink is consumed even when printing in black-and-white.

### The ink lamp indicates when ink is running low.

You can confirm the status of each ink tank by the ink lamps. Open the print head cover of the printer to confirm how the ink lamps light or flash.

When the ink is running low, the ink lamp flashes slowly (about 3-second interval) to indicate that the ink is running low.

Then, when the ink runs out, the ink lamp flashes fast (about 1-second interval) to indicate that the ink tank needs to be replaced with a new one.

- [Checking the Ink Status with the Ink Lamps](#)

# Key Points to Successful Printing

## Check the printer status before printing!

- Is the print head OK?

If a print head nozzle is clogged, print will be faint and papers will be wasted. Print the nozzle check pattern to check the print head.

■ [Maintenance Procedure](#)

- Is the inside of the printer smeared with ink?

After printing large quantities of paper or performing borderless printing, the area where papers go through may get smeared with ink. Clean the inside of your printer with [Bottom Plate Cleaning](#).

## Set the paper thickness lever according to type of loaded paper.

Set this lever to the right for normal use.

Set this lever to the left when printing on thick paper such as envelopes.

■ [Loading Envelopes](#)

## Check how to load the paper correctly!

- Is the paper loaded in the correct orientation?

To load paper in the rear tray, load paper WITH THE PRINT SIDE FACING YOU.

■ [Loading Paper](#)



- Is the paper curled?

The curled paper causes paper jam. Flatten the curled paper, then reload it.

■ "Load the paper after correcting its curl." in [Paper Is Smudged/Printed Surface Is Scratched](#)

## Be Sure to Make Paper Settings after Loading Paper

If the media type setting is not the one for the loaded paper, printing results may not be satisfactory. After loading paper, be sure to select the appropriate media type setting for the loaded paper.

### ■ [Print Results Not Satisfactory](#)

There are various types of paper: paper with special coating on the surface for printing photos with optimal quality and paper suitable for documents.

Each media type has specific preset settings, such as how ink is used and sprayed, so that you can print on that type with optimal image quality.

This allows you to print with the settings best suited for the loaded media type just by selecting that media type.

## Canceling a Print Job

### Never press the ON button!

If you press the **ON** button while printing is in progress, the print data sent from the computer queues in the printer and you may not be able to continue to print.

Press the **RESUME/CANCEL** button to cancel printing.

## Printer Handling Precautions

### Do not place any object on the print head cover!

Do not place any object on the print head cover. It will fall into the rear tray when the print head cover is opened and cause the printer to malfunction. Also, place the printer where objects will not fall on it.



## Key to Enjoying Consistent Printing Quality

The key to printing with the optimal printing quality is to prevent the print head from drying or clogging. Always observe the following rules for optimal printing quality.

### Never unplug the power cord until the power is turned off!

If you press the **ON** button to turn off the power, the printer caps the print head (nozzles) automatically to prevent from drying. If you unplug the power cord from the wall outlet before the **POWER** lamp is not lit, the print head will not be capped properly and this will cause drying or clogging.

When [unplugging the power cord](#), make sure that the **POWER** lamp is not lit.

### Print periodically!

Just as the tip of a felt pen becomes dry and unusable if it has not been used for a long time, even if it is capped, the print head too, may become dried or clogged if the printer has not been used for a long time.

We recommend you to use the printer at least once a month.

#### ►► Note

- Depending on the type of paper, ink may blur if you trace the printed area with a highlight pen or paint-stick, or bleed if water or sweat comes in contact with the printed area.

## Precautions for Safe Transport of the Printer

When relocating the printer, make sure of the following.

### ▶▶▶ Important

- Pack the printer in a sturdy box, using sufficient protective material to ensure safe transport.
- With the print head and ink tank left installed in the printer, press the **ON** button to turn off the power. This allows the printer to automatically cap the print head, thus preventing it from drying.
- Do not transport or store the printer with the front of printer (the paper output slot cover side) down as shown below.



- Before shipping the printer by a delivery service:
  - Tape the lid of the box securely with strong tape.
  - Clearly label the box as "FRAGILE" or "HANDLE WITH CARE".

1. Turn the printer off.
2. Confirm that the **POWER** lamp is off and [unplug the power cord](#).

### ▶▶▶ Important

- Do not unplug the printer while the **POWER** lamp is lit or flashing, as it may cause malfunction or damage to the printer, making the printer unable to print.

3. Retract the paper support, then close the rear tray cover and paper output slot cover.
4. Unplug the printer cable from the computer and from the printer, then unplug the universal AC adapter from the printer.

When the battery is not used for a long period of time (6 months or longer), remove the battery from the printer. For details on how to remove the battery, refer to the battery's instruction manual.
5. Use adhesive tape to secure all the covers on the printer to keep them from opening during transportation. Then pack the printer in the plastic bag.
6. Attach the protective material to both sides of the printer when packing the printer in the box.

## Legal Limitations on Use of Your Product and Use of Images

It may be unlawful to print the following documents.

The list provided is non-exhaustive. When in doubt, check with a legal representative in your jurisdiction.

- Paper money
- Money orders
- Certificates of deposit
- Postage stamps (canceled or uncanceled)
- Identifying badges or insignias
- Selective service or draft papers
- Checks or drafts issued by governmental agencies
- Motor vehicle licenses and certificates of title
- Traveler's checks
- Food stamps
- Passports
- Immigration papers
- Internal revenue stamps (canceled or uncanceled)
- Bonds or other certificates of indebtedness
- Stock certificates
- Copyrighted works/works of art without permission of copyright owner



## Carrying the Printer

Exercise sufficient care when carrying the printer.

When you remove the power cord, carry the printer, or stand it up, check that the **POWER** lamp is off.

### ▶▶ Important

- If you repeatedly remove the power cord, carry the printer, or stand it up while the **POWER** lamp is on or flashing, this may cause the ink to leak or the printer to break. (The same problem is caused even if you use the optional portable kit.) For details on turning off the printer, see [Turning off the printer](#).
- When carrying the printer, be careful not to shock the printer, to subject it to strong vibrations, to place it in the heat, or to put a heavy thing on it. This causes the printer to break or the ink to leak.

### ▶▶ Note

- Pack the printer carefully when carrying. For details, see [Precautions for Safe Transport of the Printer](#).
- X-ray and any other baggage inspection devices have no adverse effect on this printer.

## Traveling Abroad with the Printer

The universal AC adapter can be used abroad to power the printer from power supplies ranging from AC 100 V to 240 V. However, the specification of the power cord differs depending on the country or region of use.

Before traveling abroad with the printer, ensure the followings.

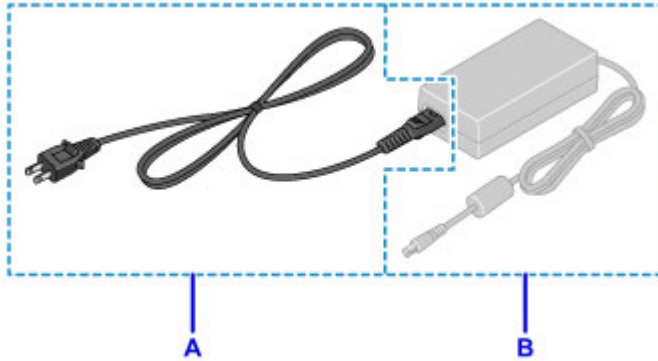

A: Power cord

Please purchase a power cord that conforms to the specifications of the country or region of use.

We recommend using a Canon genuine power cord.

B: Universal AC adapter

Universal AC adapter is not dependent on the specifications of the country or region of use.

## Accessories

The following accessories are available for this printer. Confirm the product names when you purchase the accessories.

\* Certain accessories may not be available in some countries or regions.

- LK-62

This kit allows you to use the Canon printer in location where a power outlet is unavailable. The kit contains a battery pack and a battery attachment. To charge the battery, load the battery pack in the battery attachment, and attach it to the printer, and then connect the AC adapter to the printer. For details, refer to the kit's instruction manual.

### Note

- The battery bundle model includes the printer, battery pack, and battery attachment. However, you may not be able to purchase this model in some countries or regions.
- Power cord for universal AC adapter

# Specifications

## General Specifications

<b>Printing resolution (dpi)</b>	9600* (horizontal) x 2400 (vertical) * Ink droplets can be placed with a pitch of 1/9600 inch at minimum.
<b>Interface</b>	<b>USB Port:</b> Hi-Speed USB *1 <b>LAN Port:</b> Wireless LAN: IEEE802.11n / IEEE802.11g / IEEE802.11b *2 *1 A computer that complies with Hi-Speed USB standard is required. Since the Hi-Speed USB interface is fully upwardly compatible with USB 1.1, it can be used at USB 1.1. *2 Setup possible through WPS (Wi-Fi Protected Setup), WCN (Windows Connect Now) or Cableless setup. USB and LAN can be used at the same time.
<b>Print width</b>	8 inches/203.2 mm (for Borderless Printing: 8.5 inches/216 mm)
<b>Operating environment</b>	<b>Temperature:</b> 41 to 95 °F (5 to 35 °C) <b>Humidity:</b> 10 to 90 % RH (no condensation) * The performance of the printer may be reduced under certain temperature and humidity conditions. Recommended conditions: <b>Temperature:</b> 59 to 86 °F (15 to 30 °C) <b>Humidity:</b> 10 to 80 % RH (no condensation) * For the temperature and humidity conditions of papers such as photo paper, refer to the paper's packaging or the supplied instructions.
<b>Storage environment</b>	<b>Temperature:</b> 32 to 104 °F (0 to 40 °C) <b>Humidity:</b> 5 to 95 % RH (no condensation)
<b>Power supply</b>	AC 100-240 V, 50/60 Hz
<b>Power consumption</b>	<b>Printing:</b> Approx. 10 W *1 <b>Standby (minimum):</b> Approx. 1.8 W *1*2 <b>OFF:</b> Approx. 0.2 W *1 Wireless LAN is active. *2 The wait time for standby cannot be changed.
<b>External dimensions</b>	Approx. 12.7 (W) x 7.3 (D) x 2.5 (H) inches Approx. 322 (W) x 185 (D) x 62 (H) mm * With the Paper Support and Paper Output Slot Cover retracted.
<b>Weight</b>	Approx. 4.3 lb (Approx. 2.0 kg) * With the Print Head and ink tanks installed.

<b>Print Head/Ink</b>	Total 1856 nozzles (P/BK 320 nozzles, Y/DyeBK each 256 nozzles, C/M each 512 nozzles)
-----------------------	---

## Network Specifications

<b>Communication protocol</b>	TCP/IP
<b>Wireless LAN</b>	<p><b>Supported Standards:</b> IEEE802.11n / IEEE802.11g / IEEE802.11b</p> <p><b>Frequency bandwidth:</b> 2.4 GHz</p> <p><b>Channel:</b> 1-11 or 1-13</p> <p>* Frequency bandwidth and available channels differ depending on country or region.</p> <p><b>Communication distance:</b> Indoors 164 feet/50 m</p> <p>* Effective range varies depending on the installation environment and location.</p> <p><b>Security:</b></p> <p>WEP (64/128 bits)</p> <p>WPA-PSK (TKIP/AES)</p> <p>WPA2-PSK (TKIP/AES)</p> <p><b>Setup:</b></p> <p>WPS (Push button configuration/PIN code method)</p> <p>WCN (WCN-NET)</p> <p>Cableless setup</p> <p><b>Other Features:</b> Administration password</p>

## Minimum System Requirements

Conform to the operating system's requirements when higher than those given here.

### Windows

<b>Operating System</b>	Windows 8, Windows 8.1 Windows 7, Windows 7 SP1 Windows Vista SP1, Windows Vista SP2 Windows XP SP3 32-bit only
<b>Browser</b>	Internet Explorer 8 or later
<b>Hard Disk Space</b>	3 GB Note: For bundled software installation. The necessary amount of hard disk space may be changed without notice.
<b>Display</b>	XGA 1024 x 768

### Mac OS

<b>Operating System</b>	Mac OS X v10.6.8 or later
<b>Browser</b>	Safari 5 or later

<b>Hard Disk Space</b>	1.5 GB Note: For bundled software installation. The necessary amount of hard disk space may be changed without notice.
<b>Display</b>	XGA 1024 x 768

## Other Supported OS

Some functions may not be available with each OS. Refer to the manual or the Canon web site for details on operation with iOS, Android, and Windows RT.

## Mobile Printing Capability

Apple AirPrint
Google Cloud Print
PIXMA Cloud Link

- An internet connection is required to view the *Online Manual*.
- Windows: Operation can only be guaranteed on a computer with Windows 8.1, Windows 8, Windows 7, Windows Vista or Windows XP pre-installed.
- Windows: A CD-ROM Drive or internet connection is required during software installation.
- Windows: Internet Explorer 8, 9, 10 or 11 is required to install Easy-WebPrint EX.
- Windows: Some functions may not be available with Windows Media Center.
- Windows: .NET Framework 4 or 4.5 must be installed to use the Windows software.
- Windows: XPS Essentials Pack is required to print on Windows XP.
- Mac OS: Hard Disk must be formatted as Mac OS Extended (Journaled) or Mac OS Extended.
- Mac OS: For Mac OS, an internet connection is required during software installation.
- In an in-house network environment, the 5222 port must be open. Contact the network administrator for details.

Information in this guide is subject to change without notice.

## About the Administrator Password

An administrator password "canon" is already specified for the printer at the time of purchase.

### ▶▶ Important

- For security reasons, it is recommended to change the password before you use the printer.
- You can change the password using one of the tools below. (Some tools may not be available depending on the printer you are using.)
  - operation panel of the printer
  - IJ Network Tool
  - printer information screen displayed on some Canon application software
- When you change the password, use 0 to 32 alphanumeric characters.
- If the password has been changed while you are sharing the printer and you do not know the password, ask the administrator of the printer you are using.
- The password reverts to the default setting by initializing the printer settings.

# Printing



Printing from a Computer



Printing from a Digital Camera



## Printing from a Computer

- ▶ **Printing with Application Software that You are Using (Printer Driver)**

## Printing with Application Software that You are Using (Printer Driver)

- ▶ **Printing with Easy Setup**  **Basic**
- ▶ **Various Printing Methods**
- ▶ **Changing the Print Quality and Correcting Image Data**
- ▶ **Overview of the Printer Driver**
- ▶ **Updating the Printer Driver**

## Printing with Easy Setup

The simple setup procedure for carrying out appropriate printing on this printer is as follows:

1. [Check that the printer is turned on](#)
2. [Load paper](#) on the printer
3. Select the printer

Select your model from the **Printer** list in the [Print Dialog](#).

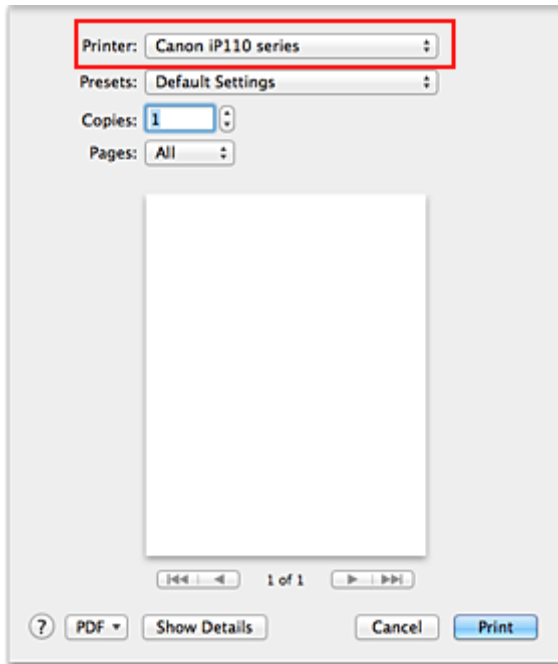

### ►►► Note

- Click **Show Details** (the disclosure triangle) to switch the Setup window to the detailed display.

4. Select the paper size

For **Paper Size**, select the paper size to be used.

If necessary, set the number of copies, the pages to be printed, and the orientation.

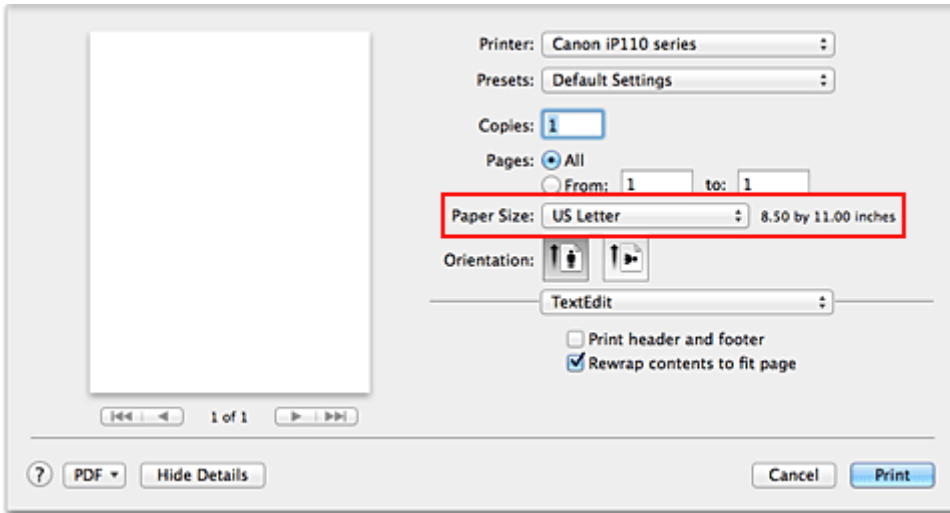

5. Select **Quality & Media** from the pop-up menu

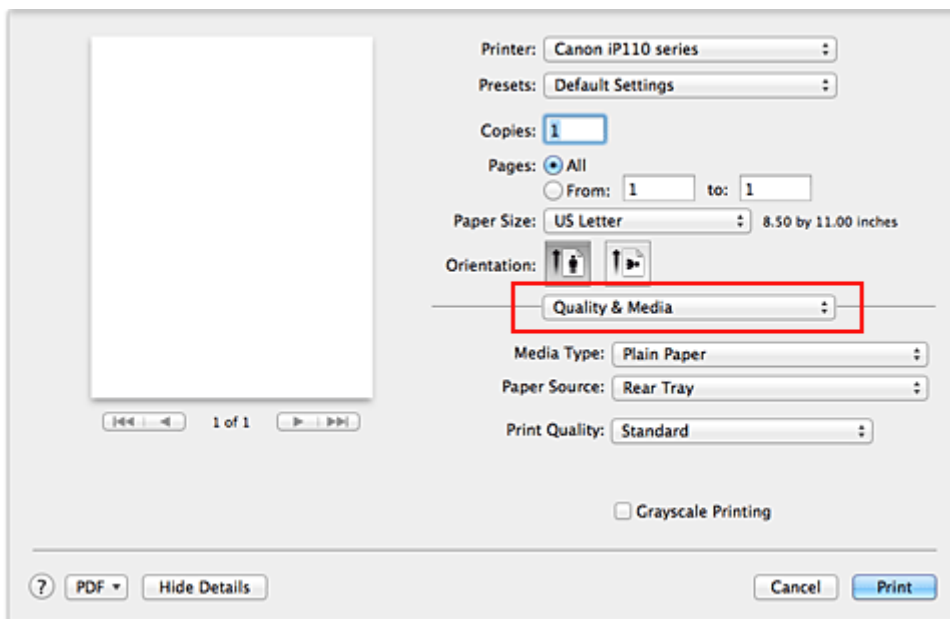

6. Select the media type

For **Media Type**, select the same paper type loaded in the printer.

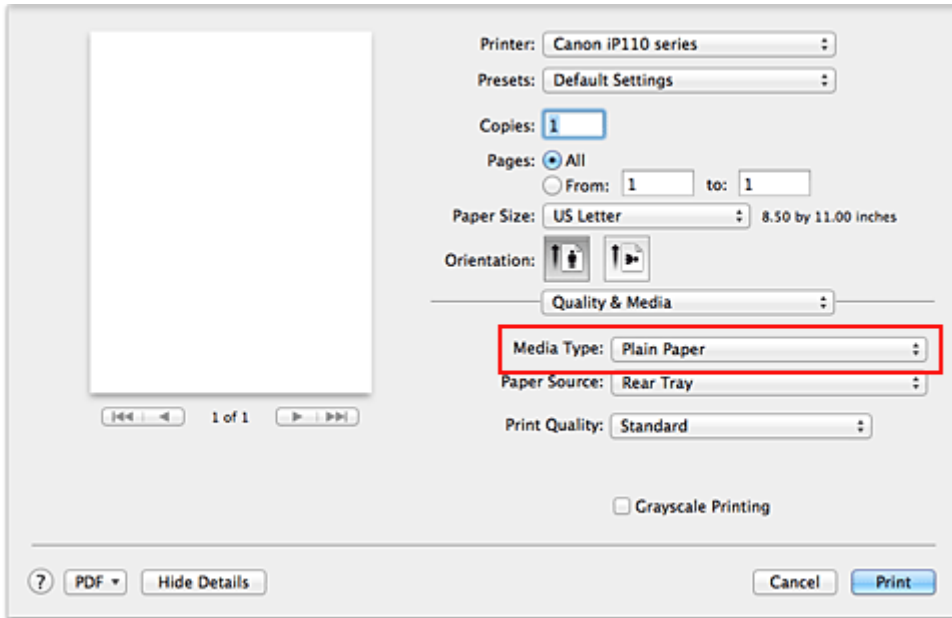

## 7. Select the print quality

For **Print Quality**, select **High**, **Standard**, or **Draft** according to your purpose.

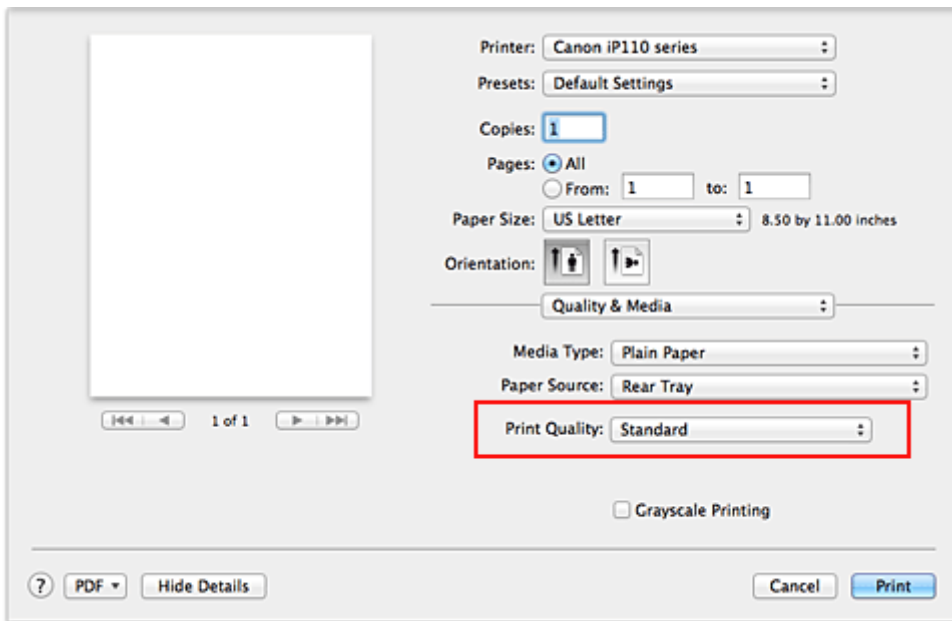

### »»» Important

- The print quality settings that can be selected may differ depending on a printing profile.

## 8. Complete the setup

Click **Print**.

When you execute print, the document will be printed in accordance with the type and size of the media.

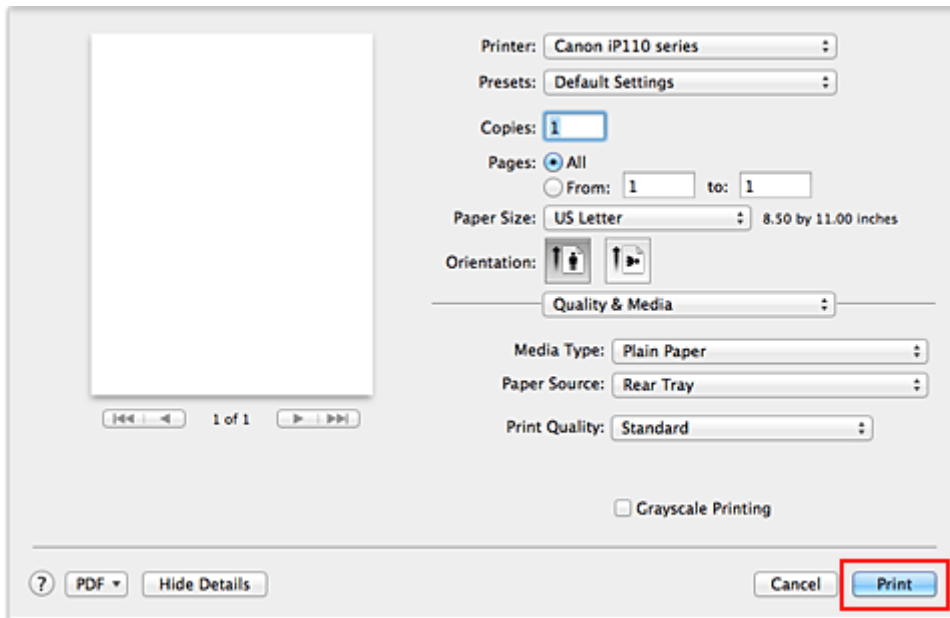

## »»» Important

- In the **Presets** section, click **Save Current Settings as Preset... (Save As...)** to [register the specified settings](#).

## Paper Settings on the Printer Driver

When you use this printer, selecting a media type that matches the print purpose will help you achieve the best print results.

You can use the following media types on this printer.

### Commercially available papers

Media name	Media Type in the printer driver
Plain Paper (including recycled paper)	<b>Plain Paper</b>
Envelopes	<b>Envelope</b>

### Canon genuine papers (Photo Printing)

Media name <Model No.>	Media Type in the printer driver
Photo Paper Plus Glossy II <PP-201>	<b>Photo Paper Plus Glossy II</b>
Photo Paper Glossy <GP-501/GP-601>	<b>Glossy Photo Paper</b>
Matte Photo Paper <MP-101>	<b>Matte Photo Paper</b>

### Canon genuine papers (Original Products)

Media name <Model No.>	Media Type in the printer driver
Photo Stickers <PS-101>	<b>Glossy Photo Paper</b>

## **Various Printing Methods**

- **Setting the Number of Copies and Printing Order**
- **Setting the Stapling Margin**
- **Execute Borderless Printing**
- **Scaling the Printing to Fit the Paper Size**
- **Scaled Printing**
- **Page Layout Printing**
- **Printing on Postcards**
- **Displaying the Print Results before Printing**
- **Setting Paper Dimensions (Custom Size)**



# Setting the Number of Copies and Printing Order

Collate pages + Reverse    Collate pages + Normal    Reverse

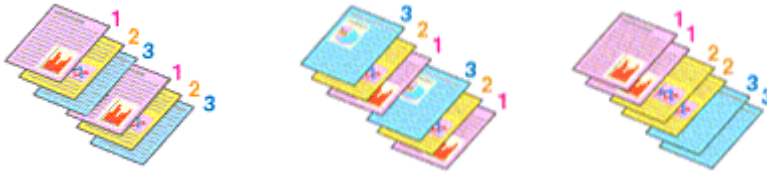

The procedure for specifying the number of copies and printing order is as follows:

1. Specify the number of copies to be printed

Specify the number of copies to print from the **Copies** in the [Print Dialog](#).

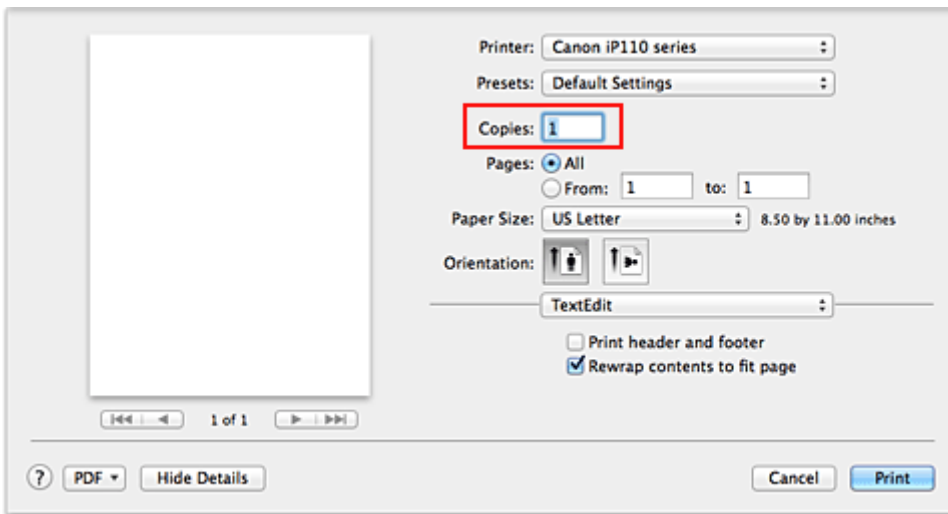

2. Select **Paper Handling** from the pop-up menu

3. Check the **Collate pages** check box when you are specifying multiple copies in the **Copies** box

Check the **Collate pages** check box to print all the pages of a single copy together.  
Uncheck this check box to print all pages with the same page number together.

4. Specify the print order

Check **Page Order**.

When you select **Automatic** or **Reverse**, printing starts from the last page.

When you select **Normal**, printing starts from the first page.

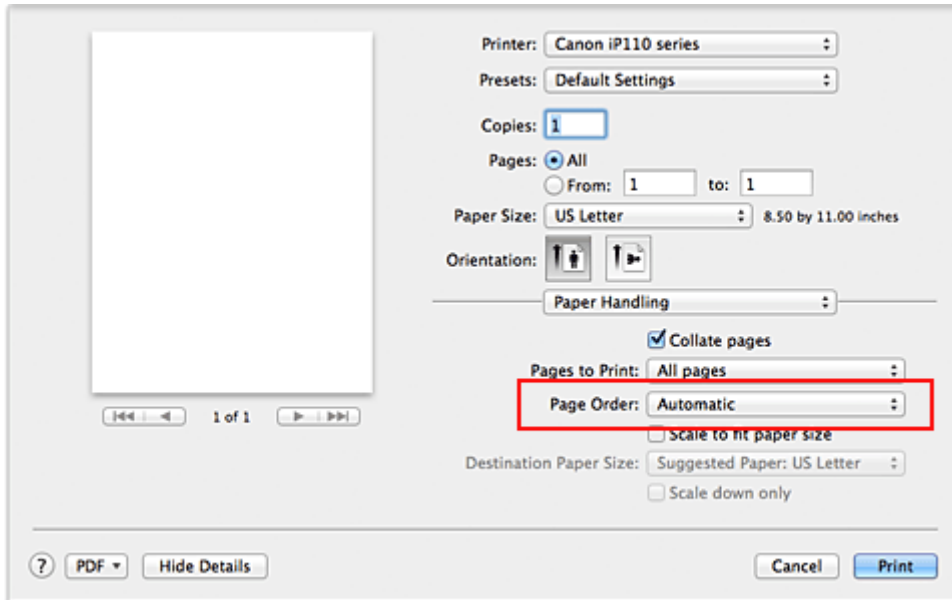

## 5. Complete the setup

Click **Print**.

When you execute print, the specified number of copies will be printed with the specified printing order.

### ▶▶▶ Important

- When the application software that you used to create the document has the same function, specify the settings on the printer driver. However, if the print results are not acceptable, specify the function settings on the application software. When you specify the number of copies and the printing order with both the application software and this printer driver, the number of copies may be multiplied numbers of the two settings or the specified printing order may not be enabled.

## Setting the Stapling Margin

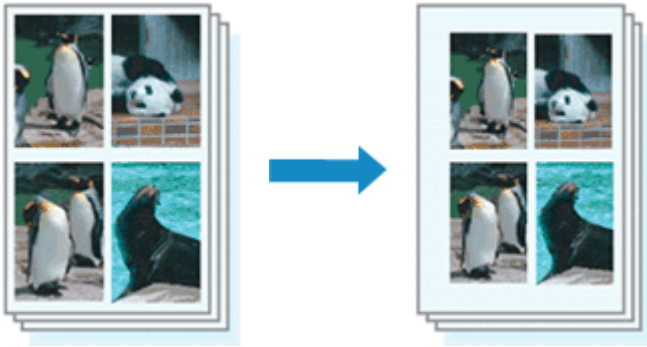

The procedure for setting the margin width and the staple side is as follows:

1. Select **Margin** from the pop-up menu on the [Print Dialog](#)

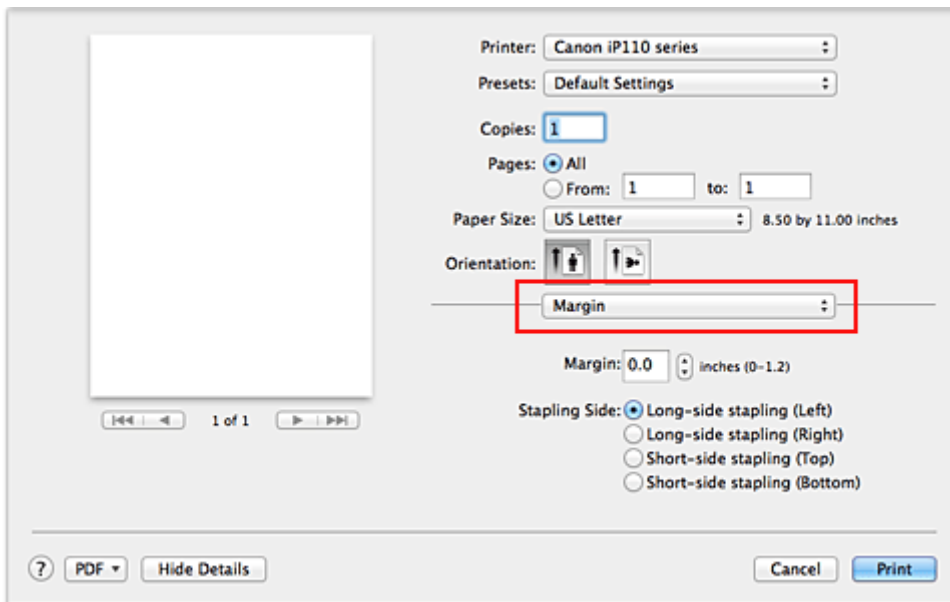

2. Set the margin width and the staple side

If necessary, set the **Margin** width, and select a stapling position from the **Stapling Side** list.

### ▶▶▶ Note

- The printer automatically reduces the print area depending on the staple position margin.

3. Complete the setup

Click **Print**.

When you execute print, the data is printed with the specified margin width and staple side.

### ▶▶▶ Important

- When borderless printing is enabled, **Margin** and **Stapling Side** appear grayed out and are unavailable.

## Execute Borderless Printing

The borderless printing function allows you to print data without any margin by enlarging the data so that it extends slightly off the paper. In standard printing, margins are created around the document area. However, in borderless printing function, these margins are not created. When you want to print data such as a photo without providing any margin around it, set borderless printing.

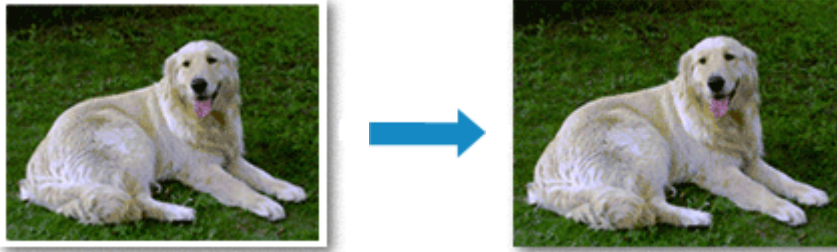

The procedure for performing borderless printing is as follows:

### Setting Borderless Printing

1. Select the size of the paper for borderless printing

Select "XXX (borderless)" from the **Paper Size** in the [Print Dialog](#).

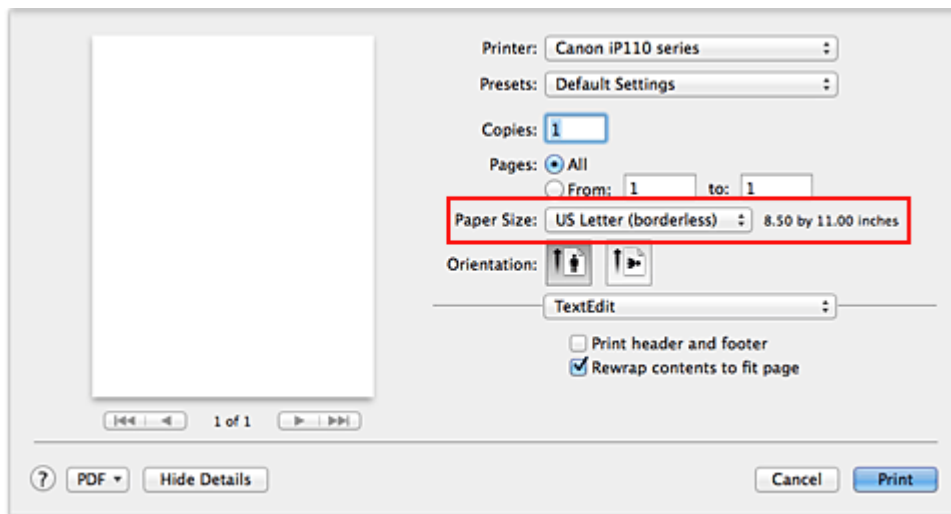

2. Select **Borderless Printing** from the pop-up menu

3. Adjust the amount of extension from the paper

If necessary, adjust the amount of extension using the **Amount of Extension** slider.

Moving the slider to the right increases the amount extending off the paper, and moving the slider to the left decreases the amount.

It is recommended to set the slider at the second position from the right for most cases.

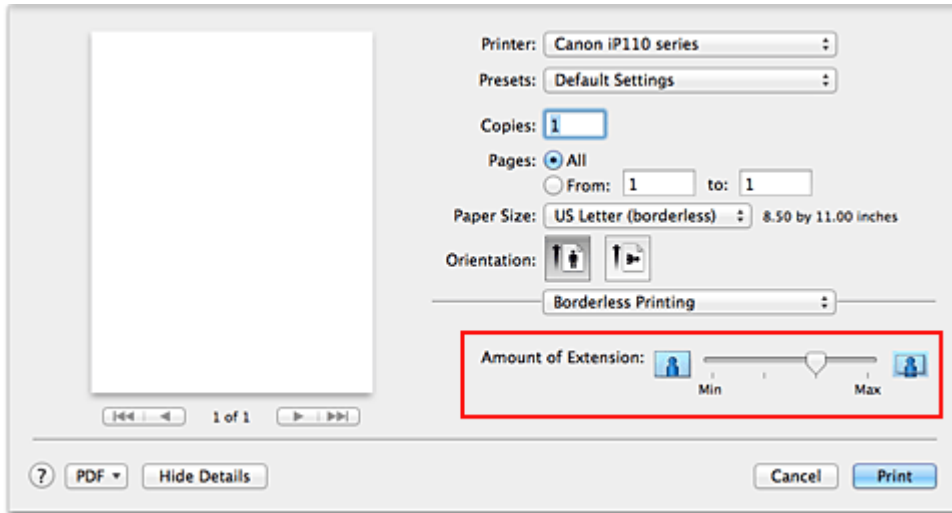

### ►►► Important

- When the **Amount of Extension** slider is set to the rightmost position, the back side of the paper may become smudged.

#### 4. Complete the setup

Click **Print**.

When you execute print, the data is printed without any margins on the paper.

### ►►► Important

- Borderless printing only supports specific paper sizes. Make sure to select a paper size with the wording "(borderless)" from the **Paper Size**.
- When borderless printing is enabled, **Envelope** appear grayed out and are unavailable in **Media Type** list of **Quality & Media** of the pop-up menu in the Print dialog.
- Print quality may deteriorate or the sheet may be stained at the top and bottom depending on the type of paper used.
- When the ratio of the height to the width differs from the image data, a portion of the image may not be printed depending on the size of the media used.  
In this case, crop the image data with an application software according to the paper size.
- When scaled printing or page layout printing is enabled, you cannot perform borderless printing.

### ►►► Note

- When **Plain Paper** is selected from the **Media Type** menu of the **Quality & Media**, borderless printing is not recommended.

## Expanding the Range of the Document to Print

Setting a large amount of extension allows you to perform borderless printing with no problems. However, the portion of the document extending off the paper range will not be printed and for this reason, the subjects around the perimeter of a photo may not be printed.

When you are not satisfied with the result of borderless printing, reduce the amount of extension. The extension amount decreases as the **Amount of Extension** slider is moved to the left.

## »» Important

- When the amount of extension is decreased, an unexpected margin may be produced on the print, depending on the size of the paper.

## »» Note

- When the **Amount of Extension** slider is set to the leftmost position, image data will be printed in the full size. If you set this when printing the address side of a postcard, the postal code of the sender is printed in the correct position.

## Scaling the Printing to Fit the Paper Size



The procedure for printing a document that is automatically enlarged or reduced to fit the page size to be used is as follows:

1. Check the paper size

Check that the **Paper Size** in the [Print Dialog](#) is the same as the paper size that you set in the application software.

2. Select **Paper Handling** from the pop-up menu

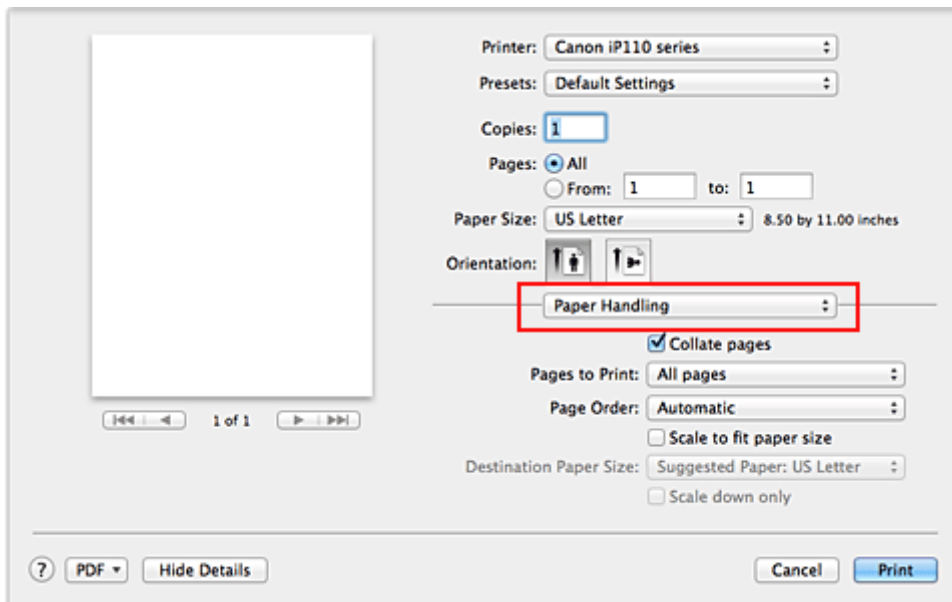

3. Set the print paper size

Check the **Scale to fit paper size** check box. Then from the **Destination Paper Size** pop-up menu, select the paper size that is actually loaded in the printer.

4. If necessary, check the **Scale down only** check box

When you check this check box, the document will be reduced to fit to the paper size when the document size is larger than the page size. The document will be printed in the original size when the document size is smaller than the page size.

5. Complete the setup

Click **Print**.

When you execute print, the document will be enlarged or reduced to fit to the page size.



## Scaled Printing



The procedure for printing a document with pages enlarged or reduced is as follows:

### 1. Select the printer

In the [Page Setup Dialog](#), select your model name from the **Format For** list.

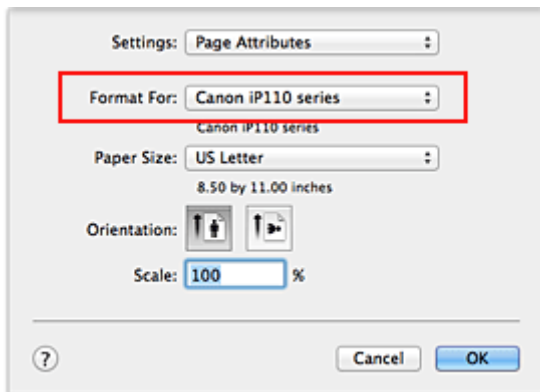

### 2. Set scaled printing

Specify the scaling factor in the **Scale** box, and click **OK**.

#### ▶▶▶ Note

- Depending on the **Scale** value that you set, an error message may be displayed.

### 3. Complete the setup

On the [Print Dialog](#), click **Print**.

When you execute print, the document will be printed with the specified scale.

#### ▶▶▶ Important

- When the application software which you used to create the original has the scaled printing function, configure the settings on your application software. You do not need to configure the same setting in the Page Setup dialog.

# Page Layout Printing

The page layout printing function allows you to print more than one page image on a single sheet of paper.

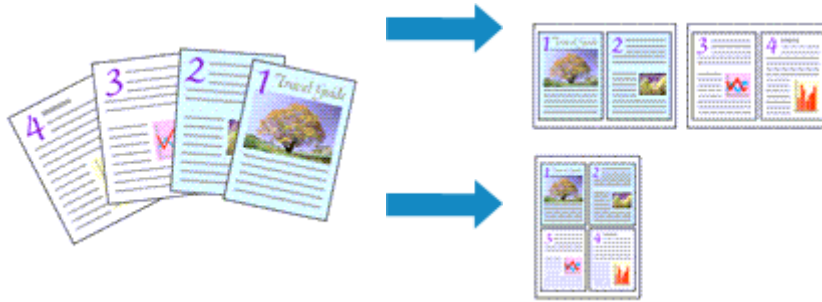

The procedure for performing page layout printing is as follows:

1. Select **Layout** from the pop-up menu in the [Print Dialog](#)

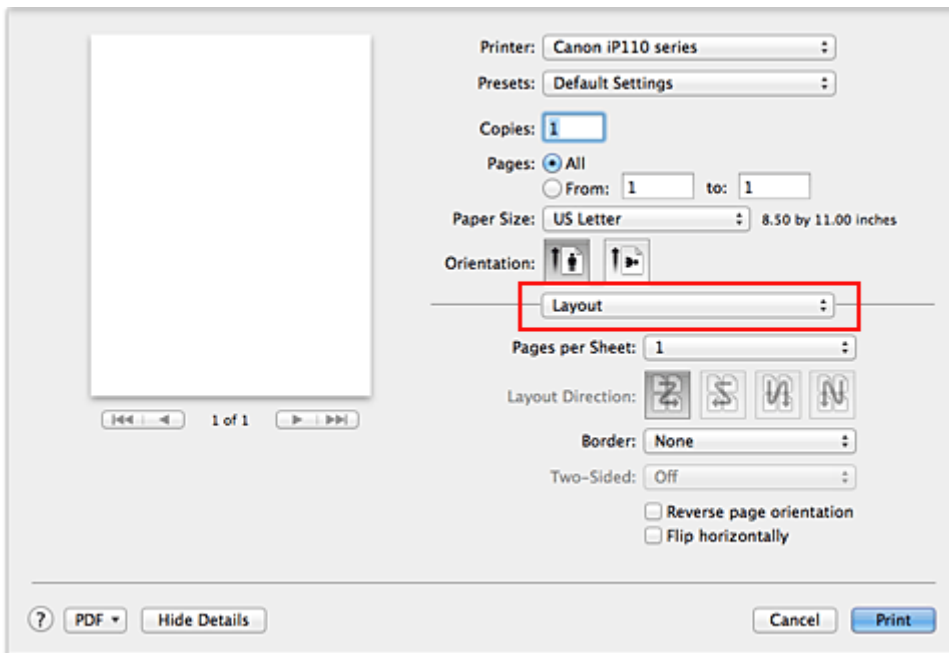

2. Set the number of original you print on one page

In **Pages per Sheet**, specify the number of page you print on one page.

3. If necessary, set the following items

### Layout Direction

To change the page placement order, select an icon from the list.

### Border

To print a page border around each document page, select a type of page border.

### Reverse page orientation

Select this check box to change the paper orientation.

### Flip horizontally

Select this check box to reverse left and right of the document.

#### 4. Complete the setup

Click **Print**.

When you execute print, the specified number of pages will be arranged on each sheet of paper in the specified order.

# Printing on Postcards

This section describes the procedure for postcard printing.

1. [Load postcard](#) on the printer
2. Select paper size in the [Print Dialog](#)

Select **Postcard** or **Postcard Double** from the **Paper Size** menu.

## »» Important

- Return postcards can be used only when you print them from the computer.
- When printing a return postcard, always set the paper size to **Postcard Double** from your application software or the printer driver.
- Do not fold the return postcard. If a crease is formed, the printer will not be able to feed the postcard properly, and this condition will cause line shifts or a paper jam.
- With return postcards, borderless printing cannot be used.

3. Select **Quality & Media** from the pop-up menu
4. Select the media type

For **Media Type**, select the same paper type loaded in the printer.

## »» Important

- This printer cannot print on postcards that have photos or stickers attached.
- When printing on each side of a postcard separately, you will get cleaner printing if you print the message side first and then print the address side.

5. Complete the setup

Click **Print**.

When you execute printing, the data will be printed onto the postcard.

## Displaying the Print Results before Printing

If you are using Mac OS X v10.6.8, you can display and check the print result before printing.

To display the print result before printing, click **Preview** on the [Print Dialog](#).

### »» Note

- When you click  (the disclosure triangle) in the Print dialog and switch to the detailed display, **Preview** is not displayed.  
For detailed display, a preview is displayed on the left side of the Print dialog.

## Setting Paper Dimensions (Custom Size)

You can specify the height and width of paper when its size cannot be selected from the **Paper Size** menu. Such a paper size is called "custom size."

The procedure for specifying a custom size is as follows:

### 1. Creating a new custom paper size

In the [Print Dialog](#), select **Manage Custom Sizes...** from **Paper Size**.

In the **Custom Paper Sizes** dialog, click +.

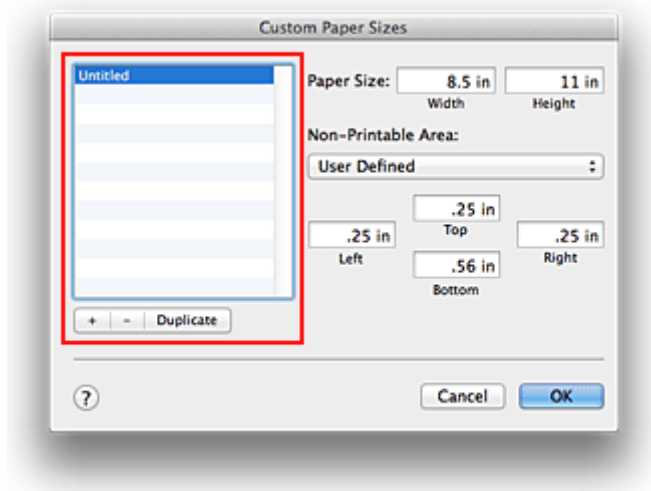

**Untitled** will be added to the list.

### 2. Setting details about the custom paper size

Double-click **Untitled**, enter the name of the paper size you want to register, and specify the **Width** and **Height** of the paper for **Paper Size**.

Select **User Defined** or your model for **Non-Printable Area**, and enter the margins.

### 3. Registering the custom paper size

Click **OK**.

The custom size is registered.

## ►► Important

- If the application software that created the document has a function for specifying height and width values, use the application software to set the values. If the application software does not have such a function or if the document does not print correctly, perform the above procedure from the printer driver to set the values.

## ►► Note

- To duplicate the registered paper size, select the paper size that you want to duplicate from the **Custom Paper Sizes** list, and click **Duplicate**.
- To delete a registered paper size, select the paper size that you want to delete from the **Custom Paper Sizes** list, and click -.

## Changing the Print Quality and Correcting Image Data

- ▶ **Setting the Print Quality Level (Custom)**
- ▶ **Printing a Color Document in Monochrome**
- ▶ **Specifying Color Correction**
- ▶ **Optimal Photo Printing of Image Data**
- ▶ **Adjusting Colors with the Printer Driver**
- ▶ **Printing with ICC Profiles (Specifying an ICC Profile from the Application Software)**
- ▶ **Printing with ICC Profiles (Specifying an ICC Profile from the Printer Driver)**
- ▶ **Adjusting Color Balance**
- ▶ **Adjusting Brightness**
- ▶ **Adjusting Intensity**
- ▶ **Adjusting Contrast**

## Setting the Print Quality Level (Custom)

The print quality level can be set in the **Custom**.

The procedure for setting the print quality level is as follows:

1. Select **Quality & Media** from the pop-up menu on the [Print Dialog](#)
2. Select the print quality

Select **Custom** for **Print Quality**.

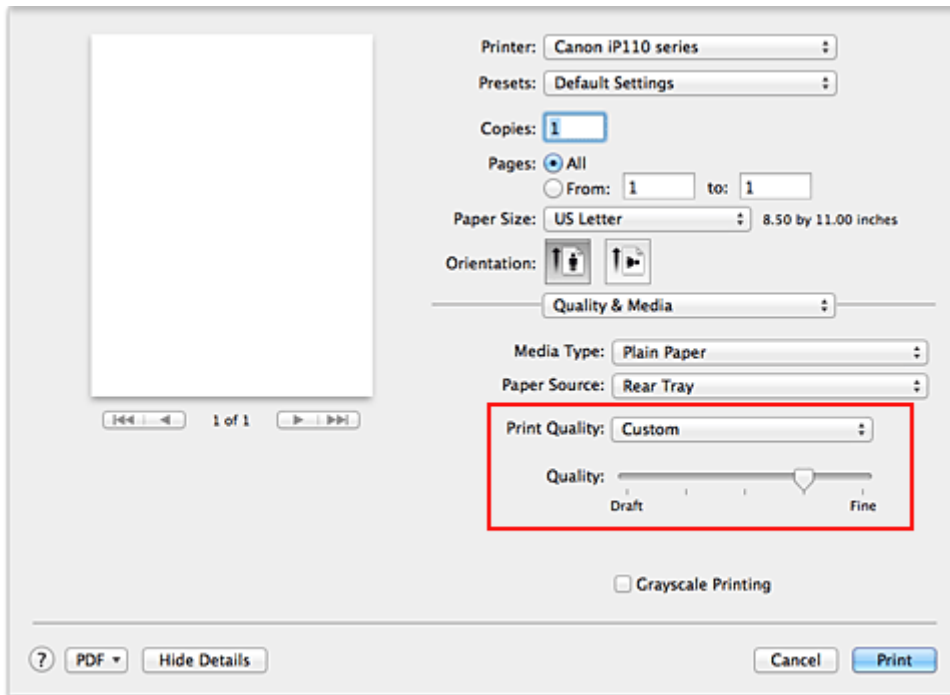

3. Setting the print quality level

Move the **Quality** slider to select the print quality level.

4. Complete the setup

Click **Print**.

When you execute print, the image data is printed with the selected print quality level.

### ►►► Important

- Certain print quality levels cannot be selected depending on the settings of **Media Type**.

## Related Topics

- [Specifying Color Correction](#)
- [Adjusting Color Balance](#)
- [Adjusting Brightness](#)
- [Adjusting Intensity](#)
- [Adjusting Contrast](#)



## Printing a Color Document in Monochrome

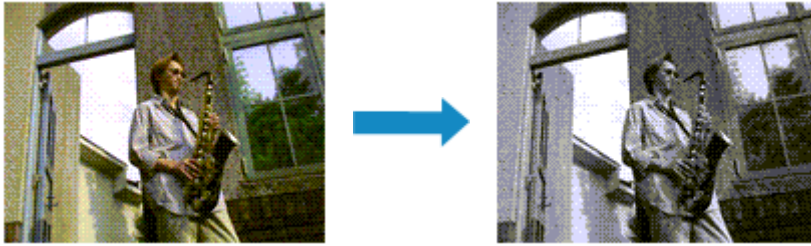

The procedure for printing a color document in monochrome is as follows:

1. Select **Quality & Media** from the pop-up menu on the [Print Dialog](#)
2. Set grayscale printing

Check the **Grayscale Printing** check box.

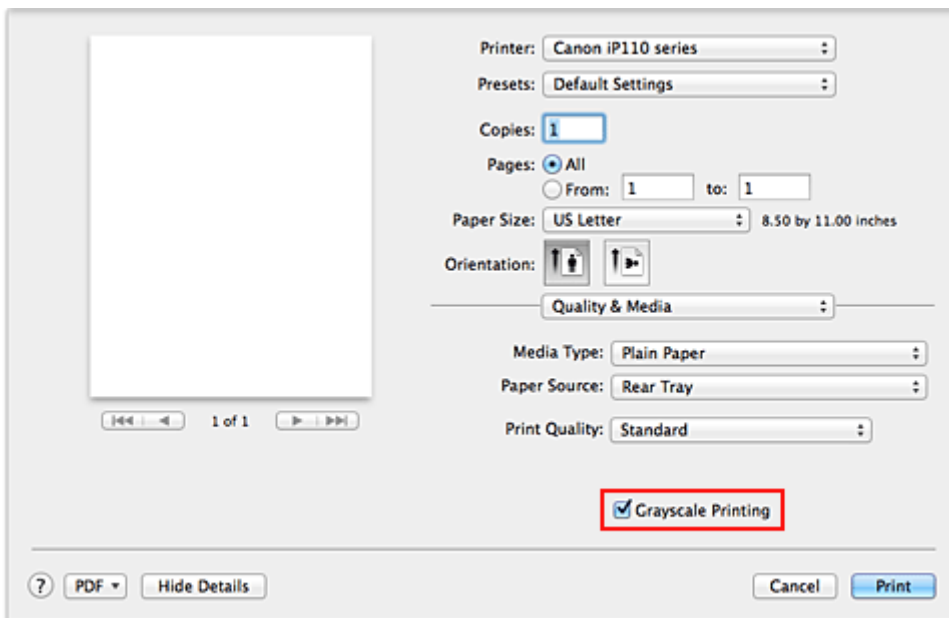

3. Complete the setup

Click **Print**.

When you execute print, the document is converted to grayscale data. It allows you to print the color document in monochrome.

### ▶▶▶ Note

- During **Grayscale Printing**, inks other than black ink may be used as well.

# Specifying Color Correction

You can specify the color correction method suited to the type of document to be printed.

Normally, the printer driver adjusts the colors by using Canon Digital Photo Color so that data is printed with color tints that most people prefer.

When you want to print by using the color space (Adobe RGB or sRGB) of the image data effectively or by specifying a printing ICC profile from your application software, select **ColorSync**. When you want to print by having the printer driver correct the colors, select **Canon Color Matching**.

The procedure for specifying color correction is as follows:

1. Select **Color Matching** from the pop-up menu of the [Print Dialog](#)

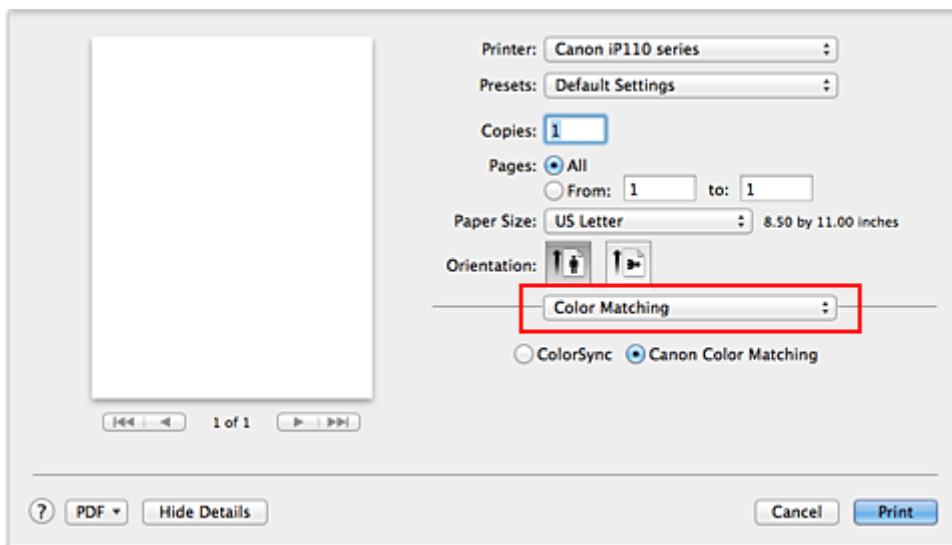

2. Select color correction

Select the item below that matches your purpose.

### ColorSync

Perform color correction using ColorSync.

### Canon Color Matching

With Canon Digital Photo Color, you can print with color tints that most people prefer.

3. Complete the setup

Click **Print**.

When you execute print, the document data is printed with the specified color correction.

## Important

- Depending on the application software, when a printing ICC profile is specified from that application software, **Canon Color Matching** cannot be selected because **ColorSync** is selected automatically.
- The **Quality & Media** setting is necessary even when **ColorSync** or **Canon Color Matching** is selected.

## Related Topics

- [Optimal Photo Printing of Image Data](#)
- [Adjusting Colors with the Printer Driver](#)

- [Printing with ICC Profiles \(Specifying an ICC Profile from the Application Software\)](#)
- [Printing with ICC Profiles \(Specifying an ICC Profile from the Printer Driver\)](#)

# Optimal Photo Printing of Image Data

When people print images taken with digital cameras, they sometimes feel that the printed color tones differ from those of actual image or those displayed on the monitor.

To get the print results as close as possible to the desired color tones, you must select a printing method that is best suited to the application software used or to your purpose.

## Color Management

Devices such as digital cameras, scanners, monitors, and printers handle color differently. Color management (color matching) is a method that manages device-dependent "colors" as a common color space.

For Mac OS, a color management system called "ColorSync" is built into the operating system. Adobe RGB and sRGB are popularly used as common color spaces. Adobe RGB has a wider color space than sRGB.

ICC profiles convert device-dependent "colors" into a common color space. By using an ICC profile and carrying out color management, you can draw out the color space of the image data within the color reproduction area that the printer can express.

## Selecting a Printing Method Suited to the Image Data

The recommended printing method depends on the color space (Adobe RGB or sRGB) of the image data or the application software to be used.

There are two typical printing methods.

Check the color space (Adobe RGB or sRGB) of the image data and the application software to be used, and then select the printing method suited to your purpose.

### Adjusting Colors with the Printer Driver

Describes the procedure for printing by using the color correction function of the printer driver.

- To print using Canon Digital Photo Color

The printer prints data with color tints that most people prefer, reproducing colors of the original image data and producing three-dimensional effects and high, sharp contrasts.

- To print by directly applying editing and touch-up results of an application software

When printing the data, the printer brings out subtle color difference between dark and light areas, while leaving the darkest and lightest areas intact.

When printing the data, the printer applies fine adjustment results, such as brightness adjustments made with an application software.

### Printing with ICC Profiles (Specifying an ICC Profile from the Application Software)

Describes the procedure for printing by using the color space of Adobe RGB or sRGB effectively.

You can print with a common color space by setting up the application software and the printer driver so that the color management matches the input ICC profile of the image data.

The method for setting up the printer driver differs depending on the application software to be used.

# Adjusting Colors with the Printer Driver

You can specify the color correction function of the printer driver to print with color tints that most people prefer through the use of Canon Digital Photo Color.

When printing from an application software that can identify ICC profiles and allows you to specify them, use a printing ICC profile in the application software, and select settings for color management.

The procedure for adjusting colors with the printer driver is as follows:

1. Select **Color Matching** from the pop-up menu of the [Print Dialog](#)

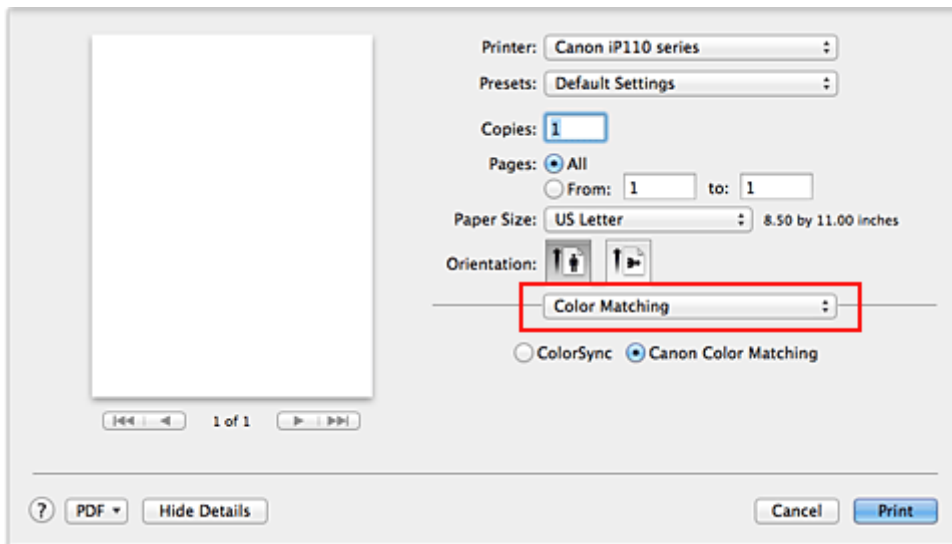

2. Select color correction

Select **Canon Color Matching**.

3. Set the other items

From the pop-up menu, select **Color Options**. If necessary, adjust the color balance (**Cyan**, **Magenta**, **Yellow**) and adjust **Brightness**, **Intensity**, and **Contrast** settings.

4. Complete the setup

Click **Print**.

When you execute print, the printer driver adjusts the colors when printing the data.

## Related Topics

- [Setting the Print Quality Level \(Custom\)](#)
- [Specifying Color Correction](#)
- [Adjusting Color Balance](#)
- [Adjusting Brightness](#)
- [Adjusting Intensity](#)
- [Adjusting Contrast](#)

# Printing with ICC Profiles (Specifying an ICC Profile from the Application Software)

When you print from Adobe Photoshop, Canon Digital Photo Professional, or any application software that can identify input ICC profiles and allows you to specify such profiles, printer uses the color management system (ColorSync) built-into Mac OS when printing. The printer prints the editing and touch-up results of the application software and effectively uses the color space of the input ICC profile specified in the image data.

To use this printing method, use your application software to select color management items and specify an input ICC profile and a printing ICC profile in the image data.

Even if you print using a printing ICC profile that you created yourself from your application software, be sure to select color management items from your application software.

For instructions, refer to the manual of the application software you are using.

1. Select **Color Matching** from the pop-up menu of the [Print Dialog](#)

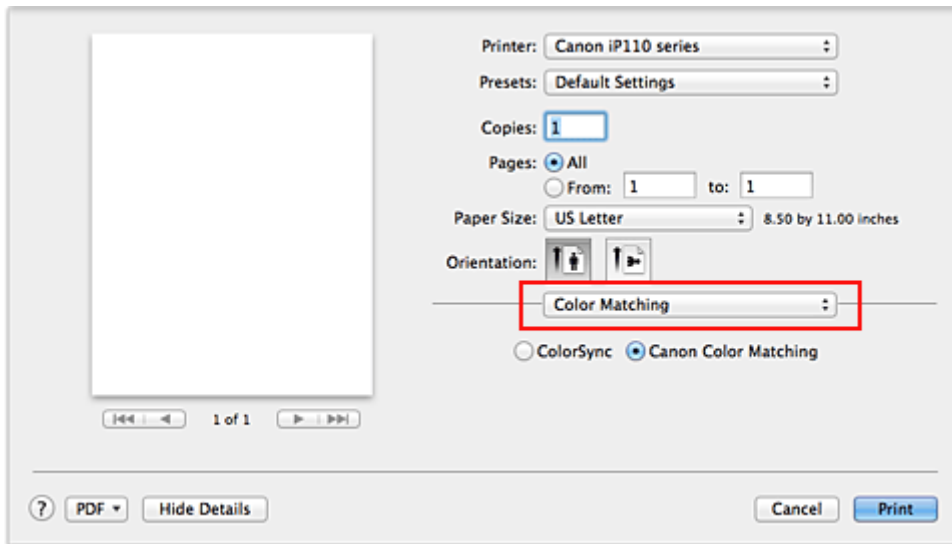

2. Select color correction

Select **ColorSync**.

You can leave **Profile** set to **Automatic**.

### Important

- Depending on the application software you use, you may not be able to select setting items other than **ColorSync**.
- If you choose a **Profile** setting other than **Automatic**, the printer will not be able to print with the correct colors.

3. Complete the setup

Click **Print**.

When you execute print, the printer uses the color space of the image data.

## Related Topics

- [Setting the Print Quality Level \(Custom\)](#)
- [Specifying Color Correction](#)

- [Adjusting Color Balance](#)
- [Adjusting Brightness](#)
- [Adjusting Intensity](#)
- [Adjusting Contrast](#)

# Printing with ICC Profiles (Specifying an ICC Profile from the Printer Driver)

Print from an application software that cannot identify or specify input ICC profiles by using the color space of the input ICC profile (sRGB) found in the data.

1. Select **Color Matching** from the pop-up menu of the [Print Dialog](#)

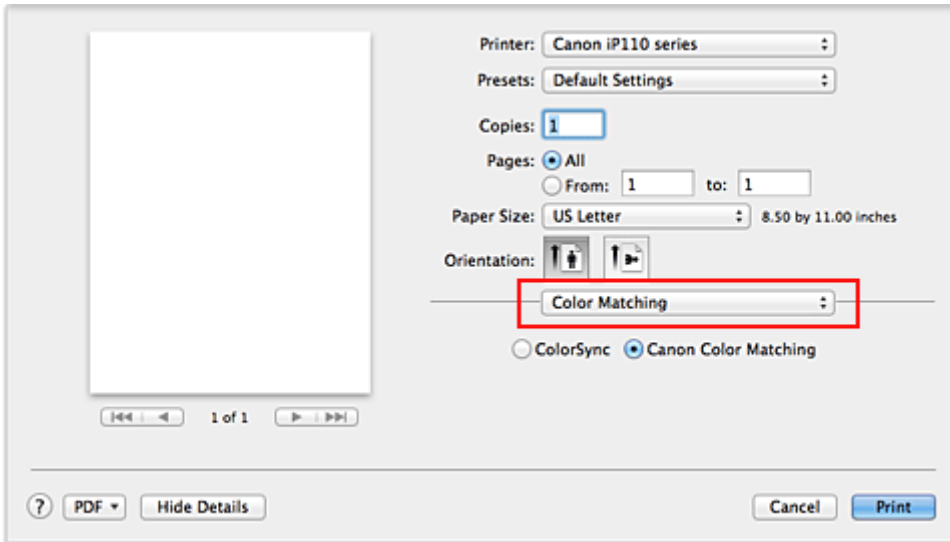

2. Select color correction

Select **ColorSync**.

You can leave **Profile** set to **Automatic**.

### »»» Important

- If you choose a **Profile** setting other than **Automatic**, the printer will not be able to print with the correct colors.

3. Complete the setup

Click **Print**.

When you execute print, the printer uses the color space of the image data.

### »»» Important

- You cannot specify an input ICC profile from the printer driver.

## Related Topics

- [Setting the Print Quality Level \(Custom\)](#)
- [Specifying Color Correction](#)
- [Adjusting Color Balance](#)
- [Adjusting Brightness](#)
- [Adjusting Intensity](#)
- [Adjusting Contrast](#)



# Adjusting Color Balance

You can adjust the color tints when printing.

Since this function adjusts color balance of the output by changing the ink ratios of each color, it changes the total color balance of the document. Use the application software when you want to change the color balance significantly. Use the printer driver only when you want to adjust the color balance slightly.

The following sample shows the case when color balance is used to intensify cyan and to diminish yellow so that the overall colors are more uniform.



No adjustment    Adjust color balance

The procedure for adjusting color balance is as follows:

1. Select **Color Options** from the pop-up menu of the [Print Dialog](#)
2. Adjust color balance

There are individual sliders for **Cyan**, **Magenta**, and **Yellow**. Each color becomes stronger when the corresponding slider is moved to the right, and becomes weaker when the corresponding slider is moved to the left. For example, when cyan becomes weaker, the color red becomes stronger.

You can also directly enter a value linked to the slider. Enter a value in the range from -50 to 50. The current settings are displayed in the settings preview on the left side of the printer driver.

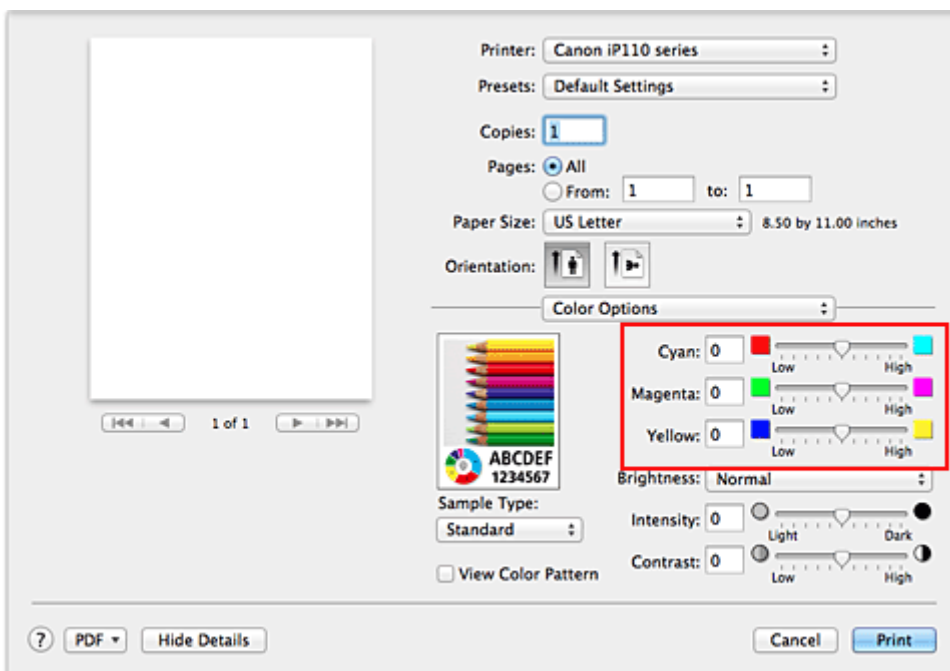

3. Complete the setup

Click **Print**.

When you execute print, the document is printed with the adjusted color balance.

### ►► Important

- When the **Grayscale Printing** check box is checked for **Quality & Media**, the color balance (**Cyan, Magenta, Yellow**) appear grayed out and are unavailable.
- If you select **ColorSync** for **Color Matching**, then the color balance (**Cyan, Magenta, Yellow**) appear grayed out and are unavailable.

### Related Topics

- [Setting the Print Quality Level \(Custom\)](#)
- [Specifying Color Correction](#)
- [Adjusting Brightness](#)
- [Adjusting Intensity](#)
- [Adjusting Contrast](#)

# Adjusting Brightness

You can change the brightness of the overall image data during printing.

This function does not change pure white or pure black but it changes the brightness of the intermediate colors.

The following sample shows the print result when the brightness setting is changed.



Light is selected

Normal is selected

Dark is selected

The procedure for adjusting brightness is as follows:

1. Select **Color Options** from the pop-up menu of the [Print Dialog](#)
2. Specify the brightness

Select **Light**, **Normal**, or **Dark** for **Brightness**. The current settings are displayed in the settings preview on the left side of the printer driver.

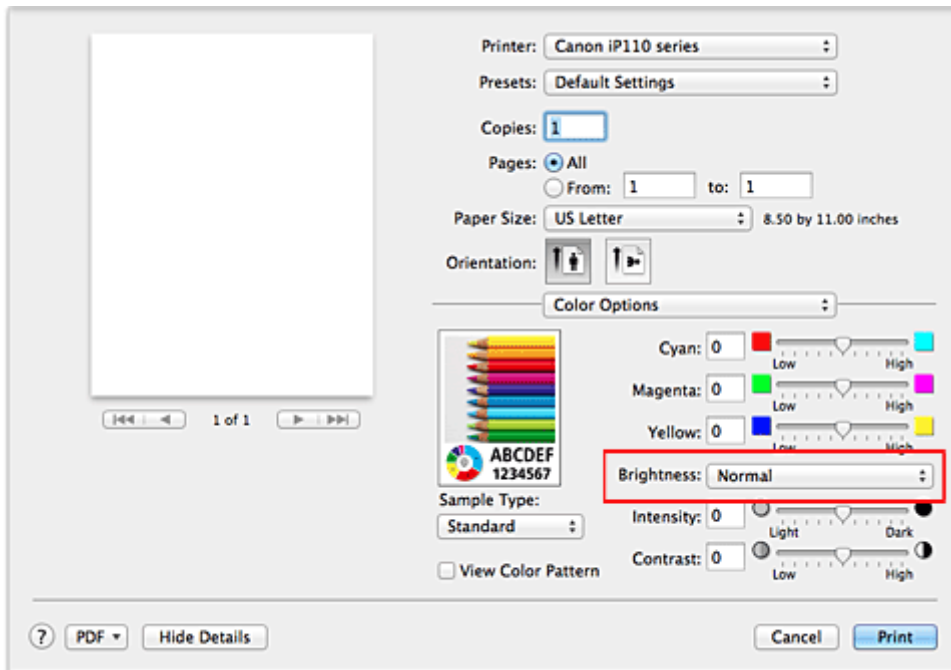

3. Complete the setup

Click **Print**.

When you execute print, the data is printed at the specified brightness.

## Important

- If you select **ColorSync** for **Color Matching**, then the **Brightness** appears grayed out and is unavailable.

## Related Topics

- [Setting the Print Quality Level \(Custom\)](#)
- [Specifying Color Correction](#)
- [Adjusting Color Balance](#)
- [Adjusting Intensity](#)
- [Adjusting Contrast](#)

# Adjusting Intensity

You can dilute (brighten) or intensify (darken) the colors of the overall image data during printing. The following sample shows the case when the intensity is increased so that all colors become more intense when the image data is printed.



No adjustment

Higher intensity

The procedure for adjusting intensity is as follows:

1. Select **Color Options** from the pop-up menu of the [Print Dialog](#)
2. Adjust intensity

Moving the **Intensity** slider to the right intensifies (darkens) the colors, and moving the slider to the left dilutes (brightens) the colors.

You can also directly enter a value linked to the slider. Enter a value in the range from -50 to 50. The current settings are displayed in the settings preview on the left side of the printer driver.

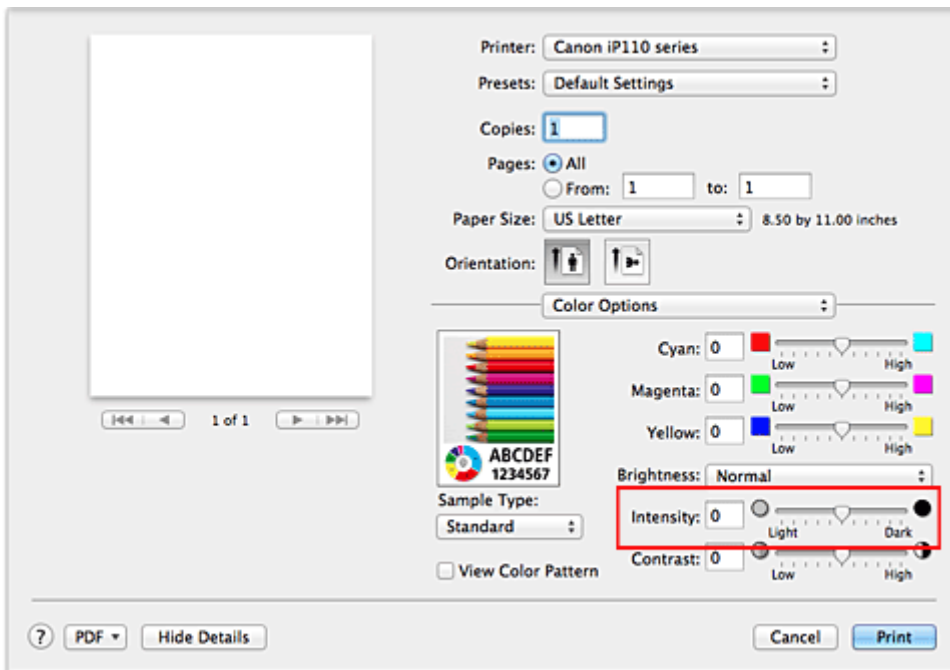

3. Complete the setup

Click **Print**.

When you execute print, the image data is printed with the adjusted intensity.

## Important

- If you select **ColorSync** for **Color Matching**, then the **Intensity** appears grayed out and is unavailable.

## Related Topics

- [Setting the Print Quality Level \(Custom\)](#)
- [Specifying Color Correction](#)
- [Adjusting Color Balance](#)
- [Adjusting Brightness](#)
- [Adjusting Contrast](#)

# Adjusting Contrast

You can adjust the image contrast during printing.

To make the differences between the light and dark portions of images greater and more distinct, increase the contrast. On the other hand, to make the differences between the light and dark portions of images smaller and less distinct, reduce the contrast.



No adjustment

Adjust the contrast

The procedure for adjusting contrast is as follows:

1. Select **Color Options** from the pop-up menu of the [Print Dialog](#)
2. Adjust the contrast

Moving the **Contrast** slider to the right increases the contrast, and moving the slider to the left decreases the contrast.

You can also directly enter a value linked to the slider. Enter a value in the range from -50 to 50. The current settings are displayed in the settings preview on the left side of the printer driver.

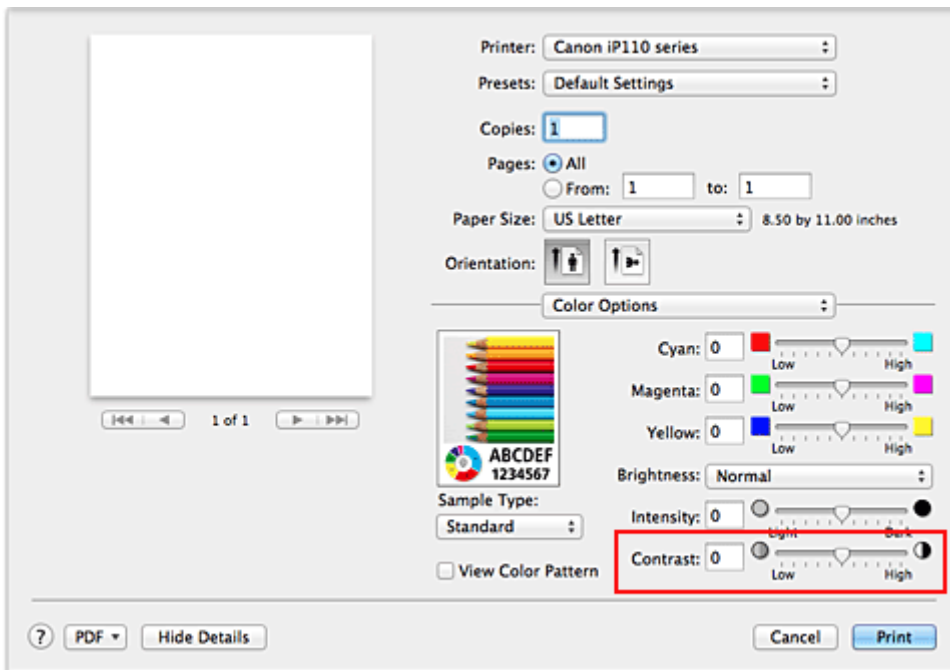

3. Complete the setup

Click **Print**.

When you execute print, the image is printed with the adjusted contrast.

## Important

- If you select **ColorSync** for **Color Matching**, then the **Contrast** appears grayed out and is unavailable.

## Related Topics

- [Setting the Print Quality Level \(Custom\)](#)
- [Specifying Color Correction](#)
- [Adjusting Color Balance](#)
- [Adjusting Brightness](#)
- [Adjusting Intensity](#)



## Overview of the Printer Driver

- **Canon IJ Printer Driver**
- **How to Open the Printer Driver Setup Window**
- **Page Setup Dialog**
- **Print Dialog**
- **Quality & Media**
- **Color Options**
- **Borderless Printing**
- **Margin**
- **Canon IJ Printer Utility**
- **Opening the Canon IJ Printer Utility**
- **Maintenance of this Printer**
- **Display the Printing Status Screen**
- **Deleting the Undesired Print Job**
- **Instructions for Use (Printer Driver)**

# Canon IJ Printer Driver

The Canon IJ printer driver (called printer driver below) is a software that is installed on your computer for printing data with this printer.

The printer driver converts the print data created by your application software into data that your printer can understand, and sends the converted data to the printer.

Because different models support different print data formats, you need a printer driver for the specific model you are using.

## Using Help of the Printer Driver

You can display Help function from the [Print Dialog](#).

Select a setup item from the pop-up menu in the Print dialog. Then click  at the bottom left of the screen to display an explanation of the item.

Help for the printer driver is displayed when the following pop-up menu item is selected:

- **Quality & Media**
- **Color Options**
- **Borderless Printing**
- **Margin**

## How to Open the Printer Driver Setup Window

You can display the printer driver setup window from the application software you are using.

### Opening the Page Setup Dialog

Use this procedure to set the page (paper) settings before printing.

1. Select **Page Setup...** from the **File** menu of the application software

The [Page Setup Dialog](#) opens.

### Opening the Print Dialog

Use this procedure to set the print settings before printing.

1. Select **Print...** from the **File** menu of the application software

The [Print Dialog](#) opens.

# Page Setup Dialog

In the Page Setup dialog, you configure the basic print settings such as the size of paper loaded in the printer or the scaling ratio.

To open the Page Setup dialog, you typically select **Page Setup...** from the **File** menu of your application software.

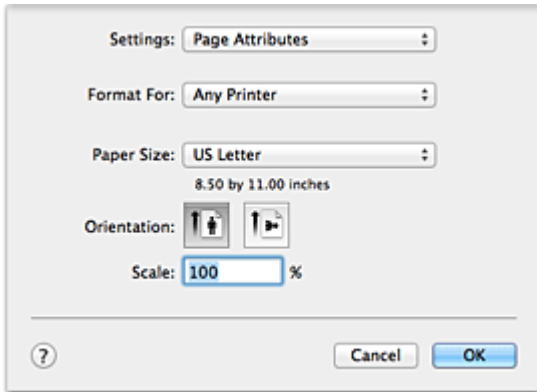

## Settings

Click the pop-up menu, and then select the following items:

### Page Attributes

Set the paper size or scaled printing.

### Save as Default

You can save the attributes of the displayed page as the default settings.

## Format For

Select the model to be used for printing.

## Paper Size

Select the size of the paper to be used for printing.

To set a non-standard size, select **Manage Custom Sizes....**

## Orientation

Select the print orientation.

## Scale

Set the scaling percentage.

You can expand or reduce the size of the document when printing.

# Print Dialog

In the Print dialog, you can set paper type and print quality to start printing.

To open the Print dialog, you typically select **Print...** from the **File** menu of your application software.

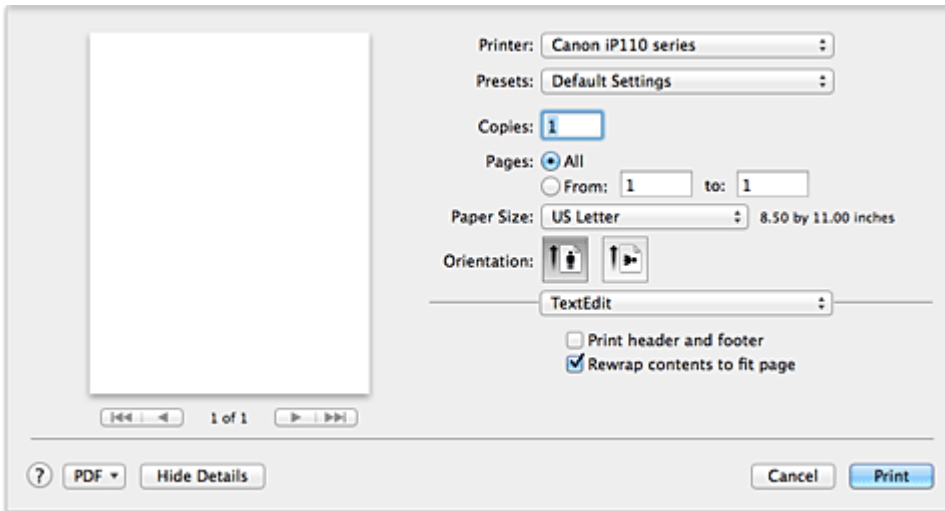

## Printer

Select the model to be used for printing.

When you click **Add Printer...**, a dialog for specifying the printer opens.

## Presets

You can save or delete the settings of the Print dialog.

### ►►► Note

- If you are using OS X Mavericks v10.9, OS X Mountain Lion v10.8, or OS X Lion v10.7, you can select **Show Presets...** to check the print settings that are set in the Print dialog.

## Copies

You can set the number of copies to be printed.

### ►►► Note

- If you are using Mac OS X v10.6.8, you can also set collate printing.
- If you are using OS X Mavericks v10.9, OS X Mountain Lion v10.8, or OS X Lion v10.7, you can set collated printing by choosing **Paper Handling** from the pop-up menu.

## Pages

You can set the range of pages to be printed.

## Paper Size

Select the size of the paper to be used for printing.

To set a non-standard size, select **Manage Custom Sizes...**

## Orientation

Select the print orientation.

## Pop-up Menu

You can switch between pages in the Print dialog by the pop-up menu. The first menu to appear differs depending on the application software that opened the Print dialog.

You can choose one of the following items from the pop-up menu.

## Layout

You can set page layout printing.

Use **Reverse page orientation** to change the paper orientation, and use **Flip horizontally** to print a mirror image of the document.

## Color Matching

You can select the color correction method.

## Paper Handling

You can set the pages to be printed on paper and the print order.

## Cover Page

You can output cover pages both before and after a document.

## Scheduler

You can set the print start time and print priorities.

## Quality & Media

You can set basic print settings that match the printer.

## Color Options

You can adjust the print colors as you desire.

## Borderless Printing

You can adjust the amount of document that extends off the paper when performing borderless printing.

## Margin

You can set the stapling side and the stapling margin.

## Supply Levels

A rough indication of the remaining ink level is displayed.

## Summary

The selected items in the Print dialog are displayed.

## Important

- If you are using OS X Mavericks v10.9, OS X Mountain Lion v10.8, or OS X Lion v10.7, you cannot use **Scheduler** and **Summary**.

## PDF

You can save a document in PDF (Portable Document Format) format.

## Preview

If you are using Mac OS X v10.6.8, when you click  (the disclosure triangle) on the side of **Printer** and switch to the simple display, **Preview** is displayed.

This button allows you to check the print results on the screen before printing.

## Quality & Media

This dialog allows you to create a basic print setup in accordance with the paper type. Unless special printing is required, normal printing can be performed just by setting the items in this dialog.

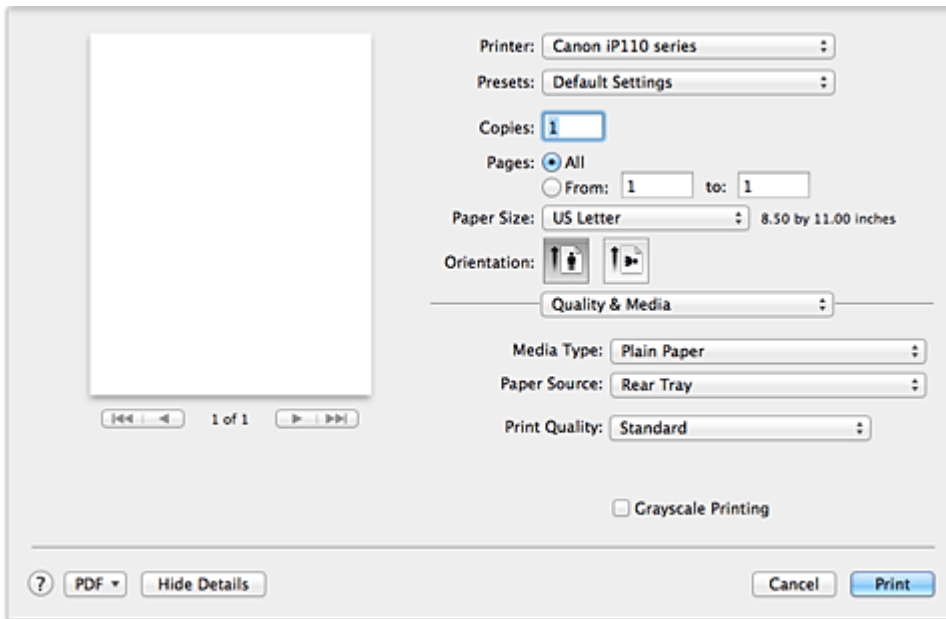

### Media Type

Select the type of media to be used.

You must select the type of media actually loaded in the printer. This selection enables the printer to carry out printing properly for the material of the media used.

### Paper Source

Shows the source from which paper is supplied.

### Print Quality

Select the one that is closest to the original document type and the purpose.

When one of the radio buttons is selected, the appropriate quality will be set automatically.

#### High

Gives priority to print quality over printing speed.

#### Standard

Prints with average speed and quality.

#### Draft

This setting is appropriate for test printing.

#### Custom

Select this radio button to specify a quality.

#### Quality

When you select **Custom** in **Print Quality**, you can use the slider bar to adjust the print quality level.

### Grayscale Printing

Set grayscale printing. Grayscale printing refers to the function of converting your document to grayscale data in the printer to print it in monochrome.

When you check the check box, both monochrome and color documents will be printed in monochrome.

When printing a color document, be sure to uncheck the check box.

## Related Topics

- [Setting the Print Quality Level \(Custom\)](#)
- [Printing a Color Document in Monochrome](#)



# Color Options

This dialog allows you to adjust the print color as you like. If the color of the printed image is not as expected, adjust the properties in the dialog and retry printing.

The adjustments made here do not affect the colors of the original print data unlike application software dedicated to image processing. Use this dialog just to make fine adjustments.

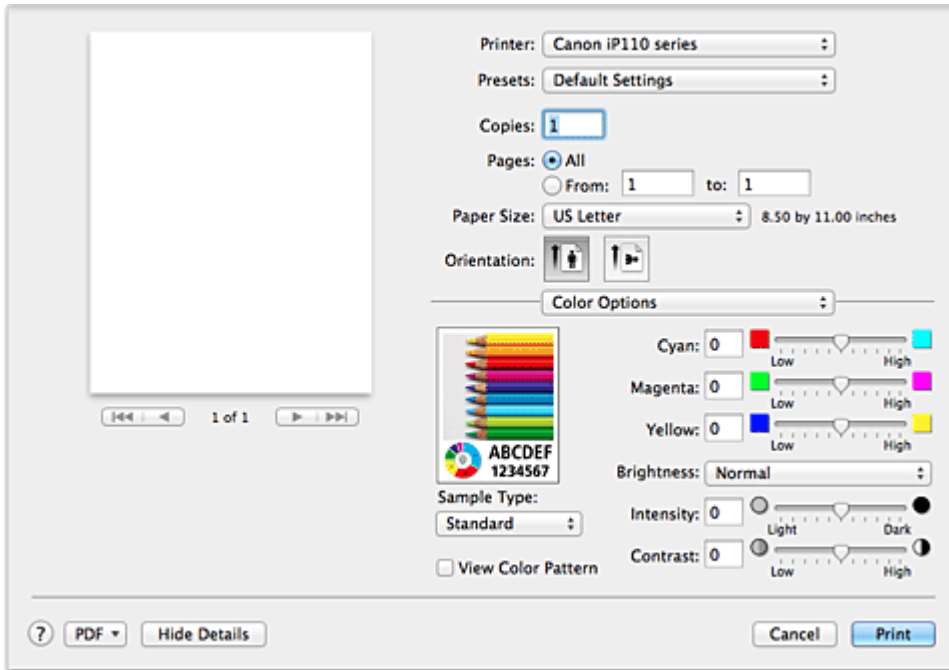

## Preview

Shows the effect of color adjustment.

As you adjust each item, the effects are reflected in the color and brightness.

## Sample Type

Select an image that you want to display as a sample.

If necessary, select one from **Standard**, **Portrait**, **Landscape**, or **Graphics**, whichever is most similar to the print results.

## View Color Pattern

Displays a pattern for checking color changes produced by color adjustment.

When you want to display the sample image with a color pattern, check this check box.

When you want to display the sample image with one that you selected with **Sample Type**, uncheck this check box.

## ▶▶▶ Note

- When the **Grayscale Printing** check box is checked in the **Quality & Media**, the graphic is displayed in monochrome.

## Color balance (Cyan, Magenta, Yellow)

If necessary, adjust the strength of each color. To strengthen a color, drag the slider to the right. To weaken a color, drag the slider to the left.

You can also directly enter a value linked to the slider. Enter a value in the range from -50 to 50.

Adjusting the color balance will result in variations in the balance among the volumes of the individual color inks and hence in the hues of the document as a whole.

Use the printer driver only when adjusting the color balance slightly. To change the color balance significantly, use the application software.

## Brightness

Select the brightness of printed images.

You cannot change the levels of pure white and black. You can change the contrast of the colors between white and black.

## Intensity

Select this method to adjust the overall density of your print.

To increase the overall intensity, drag the slider to the right. To decrease the overall intensity, drag the slider to the left.

You can also directly enter a value linked to the slider. Enter a value in the range from -50 to 50.

## Contrast

The Contrast function changes the differences between light and dark in images during printing.

To make the differences between the light and dark portions of images greater and more distinct, increase the contrast. On the other hand, to make the differences between the light and dark portions of images smaller and less distinct, reduce the contrast.

You can also directly enter a value linked to the slider. Enter a value in the range from -50 to 50.

## »» Important

- When the **Grayscale Printing** check box is checked for **Quality & Media**, the color balance (**Cyan, Magenta, Yellow**) appear grayed out and are unavailable.
- If you select **ColorSync** for **Color Matching**, then the color balance (**Cyan, Magenta, Yellow**), **Brightness**, **Intensity**, and **Contrast** appear grayed out and are unavailable.

## Related Topics

- [Specifying Color Correction](#)
- [Adjusting Color Balance](#)
- [Adjusting Brightness](#)
- [Adjusting Intensity](#)
- [Adjusting Contrast](#)

# Borderless Printing

This dialog allows you to adjust the amount of the document that extends off the paper when borderless printing is performed.

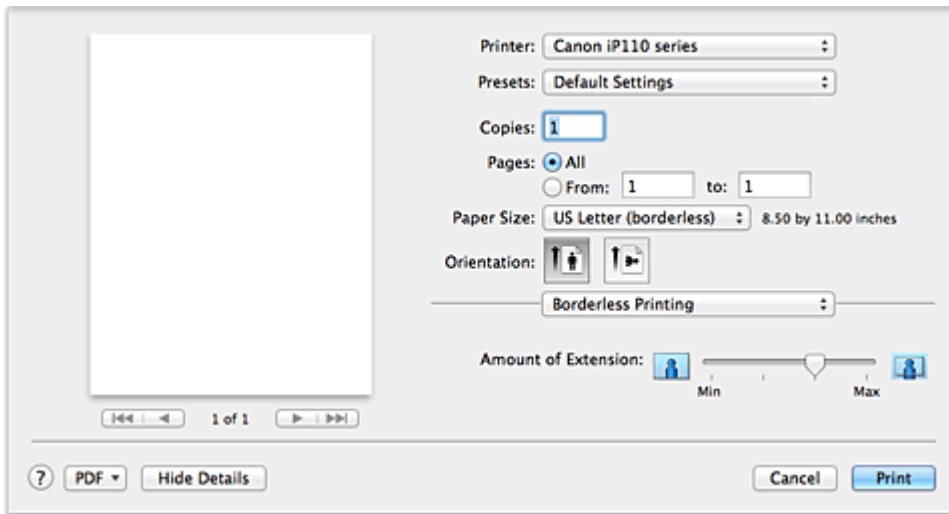

## Amount of Extension

Use the **Amount of Extension** slider to adjust the amount of the document that extends off the paper. Moving the slider to the right makes the amount larger and moving the slider to the left makes the amount smaller.

## Related Topic

- [Execute Borderless Printing](#)

# Margin

This dialog allows you to set the stapling side and amount of margin for stapling multiple sheets of paper.

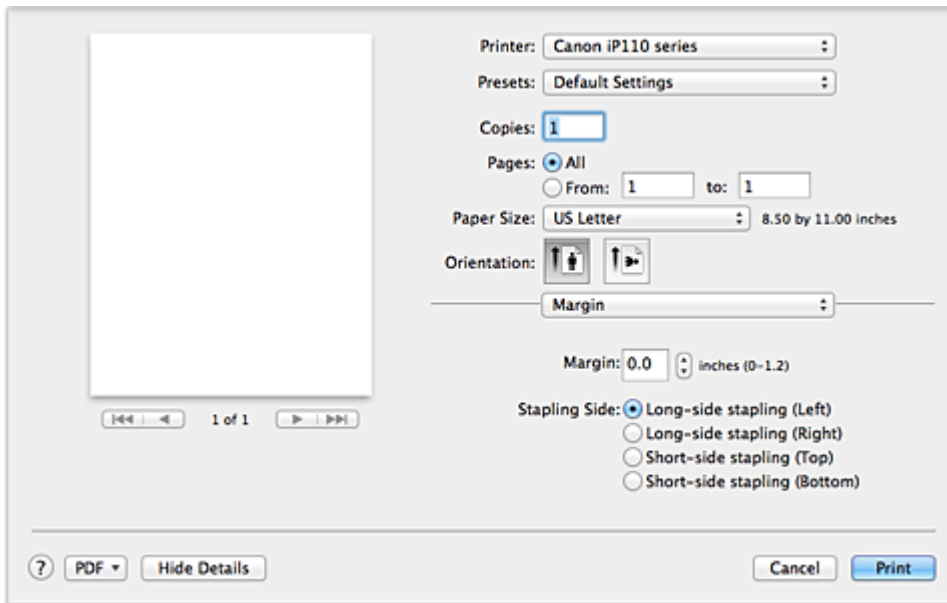

## Margin

Specify the amount of margin space for stapling the paper. Enter a value between 0 inches (0 mm) to 1.2 inches (30 mm).

## Stapling Side

Specify the stapling side.

### Long-side stapling (Left) / Long-side stapling (Right)

Select this option to staple the long side of the paper.

Choose left or right.

### Short-side stapling (Top) / Short-side stapling (Bottom)

Select this option to staple the short side of the paper.

Choose top or bottom.

## Related Topic

- [Setting the Stapling Margin](#)

# Canon IJ Printer Utility

The Canon IJ Printer Utility allows you to perform printer maintenance or change the settings of the printer.

## What You Can Do with the Canon IJ Printer Utility

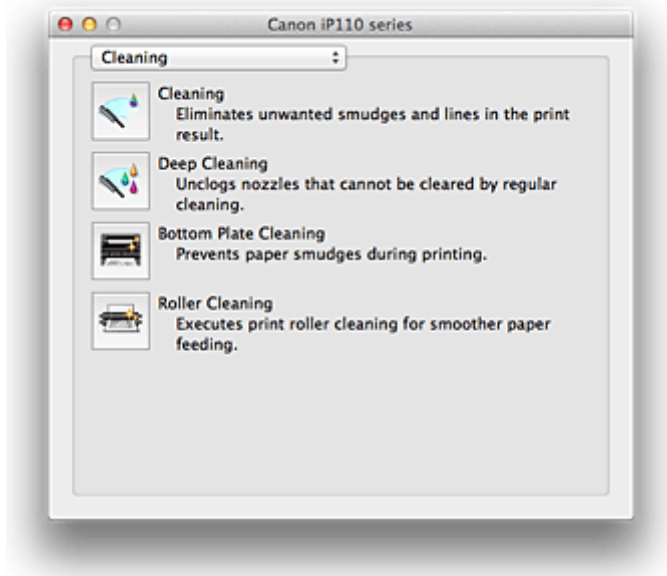

You can switch between pages in Canon IJ Printer Utility by the pop-up menu. You can choose one of the following items from the pop-up menu.

### Cleaning

Clean the printer to prevent print smudges and clear up clogged print head nozzle.

### Test Print

Execute a test print to check the condition of the print head nozzle and to adjust the print head position.

### Power Settings

Operate the power of this printer from the printer driver.

### Ink Level Information

Check the remaining ink levels.

### Ink Usage Control

You can reduce the amount of black ink used and produce the black sections with color inks.

### Battery Level Information

Check the remaining battery level.

The battery level indicator is displayed when the optional battery is being used.

### Quiet Settings

You can reduce the operating noise of the printer.

### Custom Settings

Change the settings of this printer.

## ►► Note

- To operate the Canon IJ Printer Utility, you must first turn on the printer.
- Depending on the items selected, the computer communicates with the printer to obtain information. If the computer is unable to communicate with the printer, an error message may be displayed. If this happens, click **Cancel** to display the most recent settings specified on your computer.

## Related Topics

- [Cleaning the Print Heads from Your Computer](#)
- [Cleaning Inside the Printer](#)
- [Cleaning the Paper Feed Rollers from Your Computer](#)
- [Use Your Computer to Print a Nozzle Check Pattern](#)
- [Aligning the Print Head Position from Your Computer](#)
- [Checking the Ink Status from Your Computer](#)
- [Checking the Current Battery Level](#)
- [Managing the Printer Power](#)
- [Reducing the Printer Noise](#)
- [Changing the Printer Operation Mode](#)

## Opening the Canon IJ Printer Utility

To open the Canon IJ Printer Utility, follow the steps below.

1. Open **System Preferences**, and select **Printers & Scanners (Print & Scan or Print & Fax)**

2. Start the Canon IJ Printer Utility

Select your model from the printer list, and click **Options & Supplies...**

Click **Open Printer Utility** in **Utility** tab.

Canon IJ Printer Utility is launched.

## **Maintenance of this Printer**

- **Cleaning the Print Heads from Your Computer**
- **Cleaning Inside the Printer**
- **Cleaning the Paper Feed Rollers from Your Computer**
- **Use Your Computer to Print a Nozzle Check Pattern**
- **Aligning the Print Head Position from Your Computer**
- **Checking the Ink Status from Your Computer**
- **Checking the Current Battery Level**
- **Managing the Printer Power**
- **Reducing the Printer Noise**
- **Changing the Printer Operation Mode**



# Display the Printing Status Screen

Check the print progress according to the following procedure:

## 1. Launch the printing status screen

- If the print data has been sent to the printer

The printing status screen opens automatically. To display the printing status screen, click the (the printer icon) displayed on the Dock. 

- If the print data has not been sent to the printer





Open **System Preferences**, and select **Printers & Scanners (Print & Scan or Print & Fax)**. To display the printing status screen, select the name of your printer model from the printer list, and then click **Open Print Queue....**

## 2. Checking the printing status

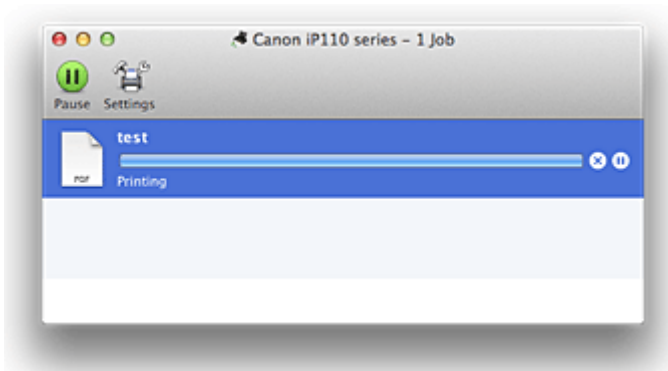
You can check the name of the file being printed or ready for being printed.







- If you are using OS X Mavericks v10.9 or OS X Mountain Lion v10.8

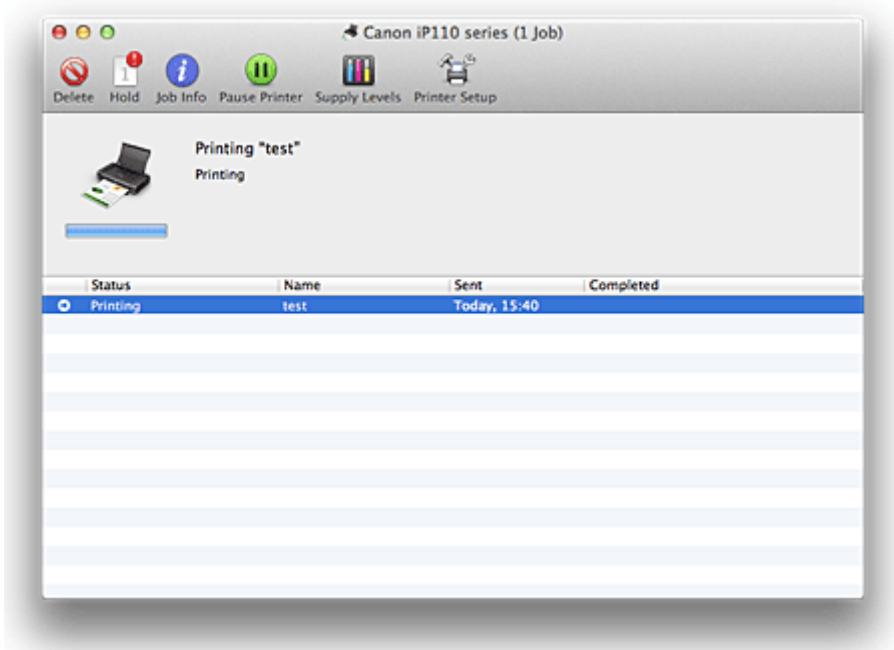

-  Deletes the specified print job.
-  Stops printing the specified document.
-  Resumes printing the specified document.
-  Stops printing all documents.
-  Displayed only when printing of all documents is being stopped, and resumes printing all documents.

- If you are using OS X Lion v10.7 or Mac OS X v10.6.8



-  Deletes the specified print job.
-  Stops printing the specified document.
-  Resumes printing the specified document.
-  Displays the print job information.
-  Stops printing all documents.
-  Displayed only when printing of all documents is being stopped, and resumes printing all documents.

## Deleting the Undesired Print Job

If the printer does not start printing, canceled or failed print job data may be remaining. Delete unnecessary print jobs from the print status check screen.

1. Open **System Preferences**, and select **Printers & Scanners (Print & Scan or Print & Fax)**

2. Select your model, and then click **Open Print Queue...**

The print status check screen appears.

3. Select the unnecessary print job and click  ( **Delete**)

The selected print jobs will be deleted.

## Instructions for Use (Printer Driver)

This printer driver is subject to the following restrictions. Keep the following points in mind when using the printer driver.

### Restrictions on the Printer Driver

- When you set up the Page Setup dialog, be sure to begin by selecting the model you are using from the **Format For** list. If you select another printer, printing may not be performed properly.
- If the Canon IJ Printer Utility does not display the remaining ink level in the **Ink Level Information**, check whether the print head and the ink tank are properly installed.
- When the Canon IJ Printer Utility displays the **Ink Level Information**, close the print head cover of the printer.
- The following functions cannot be used in Mac OS, though they can be used in Windows computers.
  - Duplex Printing
  - Booklet Printing
  - Tiling/Poster Printing
- Depending on the application software that you are using, a preview may not be displayed on the left side of the Print dialog.
- Do not start up the Canon IJ Network Tool while printing.
- Do not print when the Canon IJ Network Tool is running.
- If you connect this printer and AirPort with a USB cable and print, you must install the latest AirPort firmware.
- If you are using OS X Mavericks v10.9, close the print status check window when you perform printer maintenance from the Canon IJ Printer Utility.

### Notes on Adding a Printer

- If you will be installing the Canon printer driver on Mac OS and using the printer through a network connection, you can select **Bonjour** or **Canon IJ Network** in the **Add (Add Printer)** dialog. Canon recommends you to use **Canon IJ Network** for printing. If **Bonjour** is selected, remaining ink level messages may differ from those indicated by **Canon IJ Network**.

## Updating the Printer Driver

- **Obtaining the Latest Printer Driver**
- **Delete the Unnecessary Canon IJ Printer from the Printer List**
- **Before Installing the Printer Driver**
- **Installing the Printer Driver**

## Obtaining the Latest Printer Driver

By updating the printer driver to the latest version of the printer driver, unresolved problems may be solved.

You can access our website and download the latest printer driver for your model.

### **»» Important**

- You can download the printer driver for free, but any Internet access charges incurred are your responsibility.

### **Related Topics**

- [Before Installing the Printer Driver](#)
- [Installing the Printer Driver](#)

## Delete the Unnecessary Canon IJ Printer from the Printer List

A Canon IJ Printer that you no longer use can be deleted from the printer list.

Before deleting the Canon IJ Printer, disconnect the cable that connects the printer to the computer.

The procedure to delete the unnecessary Canon IJ Printer from the printer list is as follows:

You cannot delete the Canon IJ Printer unless you are logged in as a user with the administrative right. For information about an administrative user, refer to the user's manual for the Mac OS.

1. Open **System Preferences**, and select **Printers & Scanners (Print & Scan or Print & Fax)**

2. Delete the Canon IJ Printer from the printer list

From the printer list, select the Canon IJ Printer to be deleted, and then click -.

Click **Delete Printer** when the confirmation message appears.

### ▶▶ Note

- Even if a Canon IJ Printer is deleted from the printer list, you can re-register it automatically by connecting the printer and your computer with a USB cable.

## Before Installing the Printer Driver

This section describes the items that you should check before installing the printer driver. You should also refer to this section if the printer driver cannot be installed.

### Checking the Personal Computer Settings

- Terminate all running applications.
- Log on as a user who has the administrator account. The installer will prompt you to enter the name and password of the administrative user. When multiple users are using Mac OS, log on with the account of the administrator who registered first.

#### **»» Important**

- When you upgrade Mac OS, all printer drivers that were installed will be deleted. If you plan to continue using this printer, re-install the latest printer driver.

### Related Topics

- [Obtaining the Latest Printer Driver](#)
- [Installing the Printer Driver](#)



# Installing the Printer Driver

You can access our web site through the Internet and download the latest printer driver for your model.

The procedure for installing the downloaded printer driver is as follows:

## 1. Mount the disk

Double-click the disk image file you have downloaded.  
The file is unpacked, and then the disk is mounted.

## 2. Start the installer

Double-click "PrinterDriver\_XXX\_YYY.pkg" (where "XXX" is your model name, and "YYY" is version) contained in the disk.

## 3. Start the installation

Install the printer driver according to the messages on the screen.

When the Software License Agreement is displayed, check the contents, and click **Continue**. If you do not agree to the terms of the Software License Agreement, you cannot install this software.

## 4. Selecting the install destination

If necessary, select where you want to install the printer driver, and then click **Continue**.

## 5. Executing the installation

Click **Install**.

When the authentication screen is displayed, enter the name and password of the administrator, and then click **Install Software (OK)**.

## 6. Complete the installation

When the completion message appears, click **Close**.

The printer driver is installed successfully.

### **Important**

- If the Installer does not operate properly, select **Quit Installer** from the **Installer** menu of the Finder to quit the Installer. Then start the Installer again.
- You can download the printer driver for free, but you are responsible for paying any connection fees to the Internet.

## Related Topics

- [Obtaining the Latest Printer Driver](#)
- [Delete the Unnecessary Canon IJ Printer from the Printer List](#)
- [Before Installing the Printer Driver](#)

## Printing from a Digital Camera

- [Printing Photographs Directly from a PictBridge \(Wireless LAN\) Compliant Device](#)
- [About PictBridge \(Wireless LAN\) Print Settings](#)

## Printing Photographs Directly from a PictBridge (Wireless LAN) Compliant Device

You can connect a PictBridge (Wireless LAN) compliant device such as a digital camera, camcorder, or mobile phone to the printer through wireless LAN, and print recorded images directly without using a computer.

### Connectable devices:

PictBridge (Wireless LAN) compliant device

### Printable image data format:

The printer accepts images\* taken with a camera compliant with the Design rule for Camera File system and PNG files.

\* Exif 2.2/2.21/2.3 compliant

### ▶▶▶ Important

- LAN connection with the printer is required to use this function.

### ▶▶▶ Note

- PictBridge is the Standard to print your photos directly without using a computer, connecting a device such as a digital still camera, digital camcorder, or camera-equipped mobile phone.

In this manual, PictBridge printing with the wireless LAN connection is referred to as "PictBridge (Wireless LAN)."

- When printing photos with the PictBridge (Wireless LAN) compliant device connected to the printer, we recommend the use of the AC adapter supplied with the device. If you are using the device battery, be sure to charge it fully.
- Depending on the model or brand of your device, you may have to select a print mode compliant with PictBridge (Wireless LAN) before connecting the device. You may also have to turn on the device or select Play mode manually after connecting the device to the printer.

Perform necessary operations on the PictBridge (Wireless LAN) compliant device before connecting it to this printer according to instructions given in the device's instruction manual.

1. [Make sure that the printer is turned on.](#)
2. [Load paper.](#)
3. Connect the PictBridge (Wireless LAN) compliant device to the printer.

Detect the printer with the PictBridge (Wireless LAN) compliant device and connect the PictBridge (Wireless LAN) compliant device to the printer with wireless LAN.

### ▶▶▶ Note

- For details on how to detect the printer, refer to your PictBridge (Wireless LAN) compliant device's instruction manual.

4. Specify the print settings such as the paper type and layout.

You can perform settings using the menu on the LCD of your PictBridge (Wireless LAN) compliant device. Select the size and type of paper that you loaded in the printer.

■ [Settings on a PictBridge \(Wireless LAN\) Compliant Device](#)

5. Start printing from your PictBridge (Wireless LAN) compliant device.

# About PictBridge (Wireless LAN) Print Settings

## Settings on a PictBridge (Wireless LAN) Compliant Device

This section describes the PictBridge (Wireless LAN) function of the printer. For the print settings on a PictBridge (Wireless LAN) compliant device, refer to the instructions given in the device's instruction manual.

### ▶▶ Note

- In the following description, names of setting items are given according to those used in Canon-brand PictBridge (Wireless LAN) compliant devices. Setting item names may be different depending on the brand or model of your device.
- Some setting items explained below may not be available on some devices. When you cannot change print settings on a device, the printer prints images as follows:

Paper size: 4" x 6"/ 10 x 15 cm

Paper type: Photo

Layout: 1-up, Borderless

Date/File No. Print: Not printed

Image Optimize: The Auto photo fix function will be used for optimized printing.

The following settings can be used when printing from a PictBridge (Wireless LAN) compliant device.

Paper size	4" x 6"/ 10 x 15 cm, 5" x 7"*, 8" x 10"/ 20 x 25 cm, A4, 8.5" x 11"(Letter) * Can be selected only on certain Canon-brand PictBridge (Wireless LAN) compliant devices. (May not be selected depending on the device.)
Paper type	<ul style="list-style-type: none"> <li>• Default: Photo Paper Plus Glossy II PP-201</li> <li>• Photo: Photo Paper Plus Glossy II PP-201/Photo Stickers* * When printing on sticker paper, select <b>4"x6"/10x15cm</b> in <b>Paper size</b>. Do not set <b>Layout</b> to <b>Borderless</b>.</li> <li>• Plain: A4/Letter sized plain paper When <b>Paper type</b> is set to <b>Plain</b>, borderless printing will be disabled even when <b>Layout</b> is set to <b>Borderless</b>.</li> </ul>
Layout	Default (Borderless), Index, Bordered, Borderless, N-up (2, 4, 9, 16)*1, 20-up*2, 35-up*3 *1 Layout compatible with A4 or Letter-sized paper and Canon-brand sticker above. -A4/Letter: 4-up -Photo Stickers: 2-up, 4-up, 9-up, 16-up. *2 With a Canon brand PictBridge (Wireless LAN) compliant device, selecting items with "i" mark allows you to print shooting info (Exif Data) in list format (20-up) or on the margins of the specified data (1-up). (May not be available with some Canon-brand PictBridge (Wireless LAN) compliant devices.) *3 Printed in 35 mm Film Style Layout (Contact Printing Layout). Available only with a Canon-brand PictBridge (Wireless LAN) compliant device. (May not be available with some Canon-brand PictBridge (Wireless LAN) compliant devices.)

Print date & file no.	Default (Off: No printing), Date, File No., Both, Off
Image optimize	<p>Default (Auto photo fix)*1, On (Auto photo fix)*1, Off, Red-Eye*2</p> <p>*1 The scene or person's face of a shot photo is recognized and the most suitable correction for each photo is made automatically. It makes a darkened face by backlight brighter to print. It also analyzes a scene such as scenery, night scene, person, etc. and corrects each scene with the most suitable color, brightness, or contrasts automatically to print.</p> <p>*2 Can be selected only on certain Canon-brand PictBridge (Wireless LAN) compliant devices. (May not be selected depending on the device.)</p>
Trimming	Default (Off: No trimming), On (follow the camera's setting), Off

## **Troubleshooting**

- ▶ **The Printer Cannot Be Powered On**
- ▶ **Printing Does Not Start**
- ▶ **Paper Does Not Feed Properly/"No Paper" Error Occurs**
- ▶ **Print Results Not Satisfactory**
- ▶ **Ink Is Not Ejected**
- ▶ **Paper Jams**
- ▶ **If an Error Occurs**

### **Search Each Function**

- ▶ **Problems with Network Communication**
- ▶ **Problems with Printing**
- ▶ **Problems with Printing Quality**
- ▶ **Problems with the Printer**
- ▶ **Problems with Installation/Downloading**
- ▶ **About Errors/Messages Displayed**
- ▶ **If You Cannot Resolve the Problem**

## **Problems with Network Communication**

- **Problems with the Printer While Using with Network**
- **Cannot Detect a Printer on a Network**
- **Other Problems with Network**



## **Problems with the Printer While Using with Network**

- **The Printer Stopped Working Suddenly**
- **Printing Speed Is Slow**
- **Cannot Use the Printer on Replacing an Access Point or Changing Its settings**

# The Printer Stopped Working Suddenly

■ [Cannot Communicate with the Printer over the Wireless LAN](#)

■ [Cannot Communicate with the Printer Using the Access Point Mode](#)

■ [Cannot Print from a Computer Connected to the Network](#)

## Cannot Communicate with the Printer over the Wireless LAN

**Check1** Make sure that the printer is turned on.

**Check2** Make sure that the network settings in the printer are identical with those of the access point.

Refer to the instruction manual provided with the access point or contact its manufacturer to check the access point settings, and then modify the printer settings.

■ [How to Set an Encryption Key](#)

**Check3** Make sure that the printer is not placed far away from the access point.

The access point is located indoors within the effective range for wireless communication. Locate the printer within 164 ft. / 50 m from the access point.

**Check4** Make sure that there is no obstruction.

Wireless communication between different rooms or floors is generally poor. Adjust the location of the devices.

**Check5** Make sure that there is no source of radio wave interference in your vicinity.

If a device (e.g. microwave oven) using the same frequency bandwidth as the wireless station is placed nearby, the device may cause interference. Place the wireless station as far away from the interference source as possible.

**Check6** Make sure that the network settings of the computer are correct.

For the procedures to connect a network device to the computer and set them up, refer to the instruction manual of your network device or contact its manufacturer.

**Check7** Make sure that the radio status is good and adjust the installation positions while monitoring the radio status with IJ Network Tool.

■ [Monitoring Wireless Network Status](#)

**Check8** Make sure that a valid wireless channel is used.

The wireless channel to be used may be limited depending on wireless network devices installed in the computer. Refer to the instruction manual provided with your computer or your wireless network device to specify the valid wireless channel.

**Check9** Make sure that the channel confirmed in Check 8 can communicate with the computer.

If not, change the channel set to the access point.

**Check10** Make sure that the firewall of the security software is disabled.

If the firewall function of your security software is turned on, a message may appear warning that Canon software is attempting to access the network. If the warning message appears, set the security software to always allow access.

If using any programs that switch the network environment, check their settings. Some programs will enable a firewall by default.

**Check11** When using a router, connect the printer and computer to the LAN side (same network segment).

**Check12** When the printer is connected to an AirPort Base Station via a LAN, use alphanumeric characters for the name of the network (SSID).

If the problem is not resolved, perform setup again according to the instructions on our website.

- **For placement:**

Make sure that there is no barrier or obstacle between the access point and the printer.

## Cannot Communicate with the Printer Using the Access Point Mode

**Check1** Make sure that the printer is turned on.

**Check2** Is the access point mode disabled?

Enable the access point mode following the procedure below.

1. [Make sure that the printer is turned on.](#)
2. Press and hold the **Wi-Fi** button, then release the button when the **Alarm** lamp flashes 3 times.

When the **POWER** lamp changed from flashing to lit, the access point mode is enabled.

**Check3** Is the printer selected to connect external communication devices (e.g. computers, smartphones, or tablets)?

Select an access point name (SSID) specified for the printer as a destination for external communication devices.

**Check4** Enter a password if you specify it for the printer.

**Check5** Make sure that external communication devices are not placed far away from the printer.

Do not locate external communication devices too far away from the printer.

**Check6** Make sure that there is no obstruction.

Wireless communication between different rooms or floors is generally poor. Adjust the location of the devices.

**Check7** Make sure that there is no source of radio wave interference in your vicinity.

If a device (e.g. microwave oven) using the same frequency bandwidth as the wireless station is placed nearby, the device may cause interference. Place the wireless station as far away from the interference source as possible.

**Check8** Are you trying to connect 6 devices or more?

You can connect up to 5 devices using the access point mode.

## Cannot Print from a Computer Connected to the Network

**Check1** Make sure that the network settings of the computer are correct.

For the procedures to set up the computer, refer to the instruction manual of your computer or contact its manufacturer.

**Check2** If the printer driver is not installed, install it.

Install the printer driver from our website.

**Check3** Make sure that access control is not set to the access point.

For the procedures to connect an access point and set it up, refer to the instruction manual of your access point or contact its manufacturer.

### **▶▶ Note**

- To check the MAC address or the IP address of the computer, see [Checking the IP Address or the MAC Address of the Computer](#).

## Printing Speed Is Slow

**Check1** The printer may be printing out a large job issued from another computer.

**Check2** Make sure that the radio status is good and adjust the installation positions while monitoring the radio status with IJ Network Tool.

### ■ [Monitoring Wireless Network Status](#)

Make sure that there is no barrier or obstacle between the access point and the printer. Wireless communication between different rooms or floors is generally poor. The metal, concrete, or timber including the metallic material, mud wall, or insulator may interrupt a wireless communication. If the printer cannot communicate with the computer over a wireless LAN for the wall material, place the printer and the computer in the same room or floor.

**Check3** Make sure that there is no source of interference in your vicinity.

If a device (e.g. microwave oven) using the same frequency bandwidth as the wireless station is placed nearby, the device may cause interference. Place the wireless station as far away from the interference source as possible.

## Cannot Use the Printer on Replacing an Access Point or Changing Its settings

When you replace an access point, perform network setup of the printer again.

Perform network setup again according to the instructions on our website.

If the problem is not resolved, see below.

■ [Cannot Communicate with the Printer After Applying MAC/IP Address Filtering or Entering an Encryption Key to the Access Point](#)

■ [When Encryption Is Enabled, Cannot Communicate With the Printer After the Encryption Type Was Switched on the Access Point](#)

### Cannot Communicate with the Printer After Applying MAC/IP Address Filtering or Entering an Encryption Key to the Access Point

**Check1** Confirm the access point setting.

Refer to the instruction manual provided with the access point or contact its manufacturer to confirm the access point setting. Make sure that the computer and the access point can communicate with each other under this setting.

**Check2** If you are performing MAC address filtering or IP address filtering at the access point, confirm that the MAC address or IP address for both the computer or the network device and the printer are registered.

**Check3** If you are using a WEP or WPA/WPA2 key, make sure that the encryption key for the computer or the network device and the printer matches that set to the access point.

Besides the WEP key itself, the key length, key format, the key ID to use, and the authentication method must match among the printer, the access point, and the computer.

Normally, select **Auto** for the authentication method. If you want to specify the method manually, select **Open System** or **Shared Key** according to the setting of the access point.

■ [How to Set an Encryption Key](#)

### When Encryption Is Enabled, Cannot Communicate With the Printer After the Encryption Type Was Switched on the Access Point

If the printer cannot communicate with the computer after the encryption type of the printer was switched, make sure that encryption types for the computer and the access point matches that set to the printer.

■ [Cannot Communicate with the Printer After Applying MAC/IP Address Filtering or Entering an Encryption Key to the Access Point](#)

## **Cannot Detect a Printer on a Network**

- **Cannot Detect the Printer When Setting up Network Communication**
- **The Printer Cannot Be Detected in the Wireless LAN**

## Cannot Detect the Printer When Setting up Network Communication

If the printer could not be detected on the network when setting up the network communication, confirm the network settings before redetecting the printer.

■ [Cannot Detect the Printer during Wireless LAN Setup: Check 1](#)

### ▶▶ Important

- If the printer cannot be detected while you are setting up the network communication using a USB cable, the printer may be in the access point mode. In this case, finish the access point mode and enable the wireless LAN, then try to redetect the printer.

■ [Using the Printer with the Access Point Mode](#)



## **Cannot Detect the Printer during Wireless LAN Setup: Check 1**

**Are the computer and network device (router, access point, etc.) configured and can the computer connect to the network?**

Make sure that you can view web pages on your computer.

### **If you cannot view any web pages:**

Configure the computer and network device.

For the procedures, refer to the instruction manuals supplied with the computer and network device, or contact their manufacturers.

If you can view web pages after configuring the computer and network device, try to set up the network communication from the beginning.

### **If you can view web pages:**

Go to check 2.

■ [Cannot Detect the Printer during Wireless LAN Setup: Check 2](#)

## Cannot Detect the Printer during Wireless LAN Setup: Check 2

### Does the firewall function of your security software or operation system for computer interfere with setting up the network communication?

The firewall function of your security software or operation system for computer may limit communications between the printer and your computer. Confirm the setting of firewall function of your security software or operation system or the message appearing on your computer.

#### If the firewall function interferes with setting up:

- **When the message appears on your computer:**

If the message warning that Canon software is attempting to access the network appears on the computer, set the security software to allow access.

- **When the message does not appear on your computer:**

Cancel to set up, then set the security software to allow Canon software\* to access the network.

\* Set the security software to allow **Setup.app**, **Canon IJ Network Tool.app**, **canonijnetwork.bundle**, **CIJScannerRegister.app**, **Canon IJ Scan Utility2.app**, and **CIJSUAgent.app** to access the network.

After setting the security software, try to set up the network communication from the beginning.

#### ▶▶▶ Note

- For the operation system firewall settings or the security software firewall settings, refer to the instruction manual of the computer or software, or contact its manufacturer.

#### If there is no problem with the firewall settings:

Go to check 3.

■ [Cannot Detect the Printer during Wireless LAN Setup: Check 3](#)

## **Cannot Detect the Printer during Wireless LAN Setup: Check 3**

### **Check the settings of the access point.**

Check the settings of the access point for the network connection such as IP address filtering, MAC address filtering, or DHCP function.

Make sure that the radio channel of the access point and that assigned to the printer are the same.

For details on how to check the settings of the access point, refer to the instruction manual supplied with the access point or contact its manufacturer.

## The Printer Cannot Be Detected in the Wireless LAN

**Check1** Make sure that the printer is turned on.

**Check2** Make sure that the **Wi-Fi** lamp is lit on the printer.

If the **Wi-Fi** lamp is off, the wireless LAN is disabled.

To enable wireless LAN, press and hold the **RESUME/CANCEL** button, then release the button when the **POWER** lamp flashes 10 times.

Wireless LAN is enabled and the **Wi-Fi** lamp is lit.

**Check3** When the printer is connected to the computer temporarily using a USB cable, make sure that the USB cable is connected properly.

When you set up the wireless LAN connection or change the wireless LAN settings using IJ Network Tool through USB connection, make sure that the printer is connected to the computer with a USB cable securely.

■ [Connecting the Printer to the Computer Using a USB Cable](#)

**Check4** Make sure that the printer setup is completed.

If not, perform setup according to the instructions on our website.

**Check5** When using IJ Network Tool, click **Update** to search for the printer again.

■ [Canon IJ Network Tool Screen](#)

**Check6** Make sure that the network settings in the printer are identical with those of the access point.

Refer to the instruction manual provided with the access point or contact its manufacturer to check the access point settings, and then modify the printer settings.

■ [How to Set an Encryption Key](#)

**Check7** Make sure that there is no obstruction.

Wireless communication between different rooms or floors is generally poor. Adjust the location of the devices.

**Check8** Make sure that the printer is not placed far away from the access point.

The access point is located indoors within the effective range for wireless communication. Locate the printer within 164 ft. / 50 m from the access point.

**Check9** Make sure that there is no source of radio wave interference in your vicinity.

If a device (e.g. microwave oven) using the same frequency bandwidth as the wireless station is placed nearby, the device may cause interference. Place the wireless station as far away from the interference source as possible.

**Check10** Make sure that the network settings of the computer are correct.

Make sure that the computer can communicate with the access point over the wireless LAN.

**Check11** Make sure that the firewall of the security software is disabled.

If the firewall function of your security software is turned on, a message may appear warning that Canon software is attempting to access the network. If the warning message appears, set the security software to always allow access.

If using any programs that switch the network environment, check their settings. Some programs will enable a firewall by default.

**Check12** When using a router, connect the printer and computer to the LAN side (same network segment).

**Check13** When the printer is connected to an AirPort Base Station via a LAN, use alphanumeric characters for the name of the network (SSID).

If the problem is not resolved, perform setup again according to the instructions on our website.

## **Other Problems with Network**

- ▶ **Forgot an Access Point Name, SSID, or a Network Key**
- ▶ **The Message Is Displayed on the Computer Screen During Setup**
- ▶ **The Administrator Password Set to the Printer Was Forgotten**
- ▶ **Checking Information about the Network**
- ▶ **How to Restore the Printer's Network Settings to Factory Default**

## Forgot an Access Point Name, SSID, or a Network Key

■ [Cannot Connect with an Access Point to Which a WEP or WPA/WPA2 Key Is Set \(You Forgot the WEP or WPA/WPA2 Key\)](#)

■ [How to Set an Encryption Key](#)

### Cannot Connect with an Access Point to Which a WEP or WPA/WPA2 Key Is Set (You Forgot the WEP or WPA/WPA2 Key)

For information on how to set up the access point, refer to the instruction manual provided with the access point or contact its manufacturer. Make sure that the computer and the access point can communicate with each other.

After that, set up the printer to match the settings of the access point using IJ Network Tool.

### How to Set an Encryption Key

For information on how to set up the access point, refer to the instruction manual provided with the access point or contact its manufacturer. Make sure that the computer and the access point can communicate with each other.

After that, set up the printer to match the settings of the access point using IJ Network Tool.

- **When using WEP**

The key length, key format, the key to use (one of 1 to 4), and the authentication method must match among the access point, the printer, and the computer.

In order to communicate with an access point that uses automatically generated WEP keys, you must configure the printer to use the key generated by the access point by entering it in hexadecimal format.

Normally, select **Auto** for the authentication method. Otherwise, select **Open System** or **Shared Key** according to the setting of the access point.

When the **WEP Details** screen appears after clicking **Set** on the **Access Points** screen, follow the on-screen instructions and set the key length, the key format, the key number, and the authentication to enter a WEP key.

For details, see [Changing the WEP Detailed Settings](#).

#### ▶▶▶ Note

- When the printer is connected to an AirPort Base Station via a LAN:

When the printer is connected to an AirPort Base Station via a LAN, confirm the settings in **Wireless Security** of **AirPort Utility**.

- Select **64 bit** if **WEP 40 bit** is selected for the key length in the AirPort Base Station.
- Select **1** for **Key ID**:. Otherwise your computer will not be able to communicate with the printer via the access point.

- **When using WPA/WPA2**

The authentication method, passphrase, and dynamic encryption type must match on the access point, the printer, and the computer.

Enter the passphrase configured on the access point (a sequence of between 8 and 63 alphanumeric characters, or a 64-character hexadecimal number).

Either TKIP (basic encryption) or AES (secure encryption) is selected automatically for the dynamic encryption method.

For details, see [Changing the WPA/WPA2 Detailed Settings](#).

---

**»» Note**

- This printer supports WPA/WPA2-PSK (WPA/WPA2-Personal) and WPA2-PSK (WPA2-Personal).
-



## The Message Is Displayed on the Computer Screen During Setup

■ [The Enter Password Screen Is Displayed During Setup](#)

■ [The Screen for Setting the Encryption Is Displayed After Selecting the Access Point in the Access Points Screen](#)

■ ["You are connecting the machine to the non encrypted wireless network" Is Displayed](#)

### The Enter Password Screen Is Displayed During Setup

The following screen is displayed if an administrator password is set to the printer which has already been set up to use via a network.



Enter the administrator password you have set.

#### ►► Note

- An administrator password is already specified for the printer at the time of purchase.

For details:

■ [About the Administrator Password](#)

For improving security, it is recommended to change the administrator password.

■ [Changing the Settings in the Admin Password Sheet](#)

### The Screen for Setting the Encryption Is Displayed After Selecting the Access Point in the Access Points Screen

This screen is displayed automatically if the selected access point is encrypted. In this case, configure the details to use the same encryption settings set to the access point.

For information on the encryption settings, see [Changing the Settings in the Wireless LAN Sheet](#).

### "You are connecting the machine to the non encrypted wireless network" Is Displayed

Security is not configured on the access point. The printer can still be used, so continue the setup procedure to complete it.

#### ►► Important

- If you connect to a network that is not protected with security measures, there is a risk of disclosing data such as your personal information to a third party.

## The Administrator Password Set to the Printer Was Forgotten

Initialize the printer settings.

■ ■ [Initializing the Printer Settings](#)

After initializing the printer settings, perform setup according to the instructions on our website.

# Checking Information about the Network

■ [Checking the IP Address or the MAC Address of the Printer](#)

■ [Checking the IP Address or the MAC Address of the Computer](#)

■ [Checking If the Computer and the Printer, or Computer and the Access Point Can Communicate](#)

■ [Checking the Network Setting Information](#)

## Checking the IP Address or the MAC Address of the Printer

To check the IP address or the MAC address of the printer, print out the network setting information.

■ [Printing Out Network Setting Information](#)

To display the network setting information using IJ Network Tool, select **Network Information** on the **View** menu.

■ [Canon IJ Network Tool Menus](#)

## Checking the IP Address or the MAC Address of the Computer

To check the IP address or MAC address assigned to the computer, follow the procedure below.

1. Select **System Preferences** from the Apple menu, then click **Network**.
2. Make sure that the network interface you are using on your computer is selected, then click **Advanced**.
  - In Mac OS X v10.9, Mac OS X v10.8, or Mac OS X v10.7:  
Make sure that **Wi-Fi** is selected as the network interface.
  - In Mac OS X v10.6.8:  
Make sure that **AirMac** is selected as the network interface.
3. Confirm the IP address or MAC address.
  - In Mac OS X v10.9, Mac OS X v10.8, or Mac OS X v10.7:  
Click **TCP/IP** to confirm the IP address.  
Click **Hardware** to confirm the MAC address.
  - In Mac OS X v10.6.8:  
Click **TCP/IP** to confirm the IP address.  
Click **Ethernet**, then see **Ethernet ID** to confirm the MAC address.

## Checking If the Computer and the Printer, or Computer and the Access Point Can Communicate

To check that communication is available, perform the ping test.

1. Open the **Utilities** folder in the **Applications** folder.

2. Start **Network Utility**.
3. Click the **Ping** button.
4. Make sure that **Send only XX pings** (XX are numbers) is selected.
5. Enter the IP address of the target printer or the target access point in **Enter the network address to ping..**
6. Click **Ping**.

"XXX.XXX.XXX.XXX" is the IP address of the target device.

A message such as the following is displayed.

```
64 bytes from XXX.XXX.XXX.XXX: icmp_seq=0 ttl=64 time=3.394 ms
```

```
64 bytes from XXX.XXX.XXX.XXX: icmp_seq=1 ttl=64 time=1.786 ms
```

```
64 bytes from XXX.XXX.XXX.XXX: icmp_seq=2 ttl=64 time=1.739 ms
```

```
--- XXX.XXX.XXX.XXX ping statistics ---
```

```
3 packets transmitted, 3 packets received, 0% packet loss
```

If the packet loss is 100%, the communication is not available. Otherwise, the computer is communicating with the target device.

## Checking the Network Setting Information

To check the network setting information of the printer, print out the network setting information.

■ [Printing Out Network Setting Information](#)

# How to Restore the Printer's Network Settings to Factory Default

## Important

- Note that initialization erases all network settings on the printer, and printing operation from a computer over network may become impossible. To use the printer over network, perform setup according to the instructions on our website.

Press and hold the **RESUME/CANCEL** button, then release the button when the **POWER** lamp flashes 9 times.

The network settings are initialized.

## **Problems with Printing**

- **Printing Does Not Start**
- **Paper Jams**
- **Paper Does Not Feed Properly/"No Paper" Error Occurs**
- **Printing Stops Before It Is Completed**

# Printing Does Not Start

**Check1** Make sure that the power plug is securely plugged in, then press the **ON** button to turn the printer on.

If you use a battery, make sure that it is charged, then press the **ON** button to turn the printer on. For details on how to check it, refer to the battery's instruction manual.

While the **POWER** lamp is flashing, the printer is initializing. Wait until the **POWER** lamp stops flashing and remains lit.

## ▶▶▶ Note

- When printing large data such as a photo or graphics, it may take longer to start printing. While the **POWER** lamp is flashing, the computer is processing data and sending it to the printer. Wait until printing starts.

**Check2** Make sure that the printer is connected to your computer properly.

When the printer is connected to your computer with a USB cable, make sure that the USB cable is securely plugged in to the printer and the computer, then check the followings:

- If you are using a relay device such as a USB hub, disconnect it, connect the printer directly to the computer, and try printing again. If printing starts normally, there is a problem with the relay device. Consult the reseller of the relay device for details.
- There could also be a problem with the USB cable. Replace the USB cable and try printing again.

When you use the printer over LAN, make sure that the printer is set up to be used over network correctly.

**Check3** Is the access point mode enabled?

When you print using a mode other than the access point mode, disable the access point mode in advance.

**Check4** If you are printing from the computer and there are any unnecessary print jobs, delete them.

[■ Deleting the Undesired Print Job](#)

**Check5** Make sure that your printer's name is selected in the Print dialog.

The printer will not print properly if you are using a printer driver for a different printer.

Make sure that your printer's name is selected in **Printer** in the Print dialog.

## ▶▶▶ Note

- To make the printer the one selected by default, select the printer for **Default printer**.

**Check6** Restart your computer if you are printing from the computer.

## Paper Jams

When paper is jammed, the **Alarm** lamp flashes and a troubleshooting message is displayed on the computer screen automatically. Take the appropriate action described in the message.

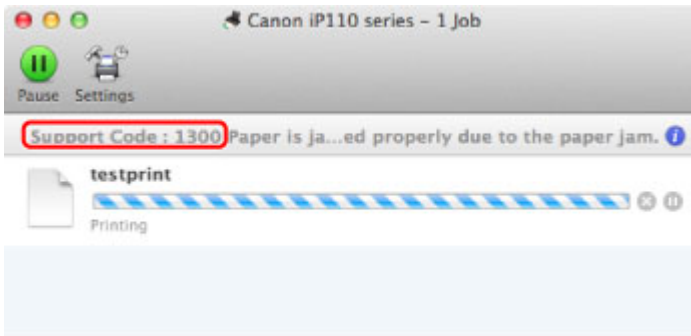

\* The screen differs depending on the OS you are using.

For details on how to remove the jammed paper, refer to [Support Code List \(When Paper Is Jammed\)](#).

### ▶▶ Note

- You can confirm the actions against errors with Support Codes on your computer by searching a Support Code.

■ [Click Here to Search](#)



# Paper Does Not Feed Properly/"No Paper" Error Occurs

**Check1** Make sure that paper is loaded.

## ■ [Loading Paper](#)

**Check2** Make sure of the following when you load paper.

- When loading two or more sheets of paper, flip through the paper before loading.



- When loading two or more sheets of paper, align the edges of the sheets before loading.
- When loading two or more sheets of paper, make sure that the paper stack does not exceed the paper load limit.

However, proper feeding of paper may not be possible at this maximum capacity depending on the type of paper or environmental conditions (either very high or low temperature and humidity). In such cases, reduce the sheets of paper you load at a time to less than half of the paper load limit.

- Always load the paper in portrait orientation, regardless of the printing orientation.
- When you load the paper, load the paper with the print side facing UP. Align the paper stack against the right side of the rear tray and slide the paper guide so that it just touches the left edge of the stack.

## ■ [Loading Paper](#)

**Check3** Check to see if the paper you are printing on is not too thick or curled.

## ■ [Media Types You Cannot Use](#)

**Check4** Make sure of the following when you load Hagakis or envelopes.

- If a Hagaki is curled, it may not feed properly even though the paper stack does not exceed the paper load limit.

Load Hagakis with a zip code column downward.

- When printing on envelopes, refer to [Loading Paper](#), and prepare the envelopes before printing.

Once you have prepared the envelopes, load them in portrait orientation. If the envelopes are placed in landscape orientation, they will not feed properly.

**Check5** Confirm that the media type and the paper size settings correspond with the loaded paper.

**Check6** Make sure that there are not any foreign objects in the rear tray.



If the paper tears in the rear tray, see [Paper Jams](#) to remove it.

If there are any foreign objects in the rear tray, be sure to turn off the printer, unplug it from the power supply, then remove the foreign object.

If you use a battery, turn off the printer, detach the battery, then remove the foreign object.



**Check7** Clean the paper feed roller.

**■** [Cleaning the Paper Feed Roller](#)

**▶▶▶ Note**

- Cleaning the paper feed roller will wear the roller, so perform this procedure only when necessary.

# Printing Stops Before It Is Completed

## Check1 Is the paper loaded?

Make sure that paper is loaded.

If the printer has run out of paper, load paper.

## Check2 Do the printing documents have lots of photographs or illustrations?

As printing large data such as photos or graphics takes time for the printer and the computer to process, the printer may appear to have stopped operating.

In addition, when printing data that uses a large amount of ink continuously on plain paper, the printer may pause temporarily. In either case, wait until the process is complete.

### ▶▶▶ Note

- If you are printing a document with a large printing area or printing multiple copies of a document, printing may pause to allow the ink to dry.

## Check3 Has the printer been printing continuously for a long period?

If the printer has been printing continuously for a long time, the print head or other parts around it may overheat. The printer may stop printing at a line break for a period of time and then resume printing.

In this case, wait for a while without operation. If the printing still does not resume, interrupt your print session at a convenient time and turn the printer off for at least 15 minutes.

### ⚠ Caution

- The print head and the surrounding area can become extremely hot inside the printer. Never touch the print head or nearby components.

## **Problems with Printing Quality**

- **Print Results Not Satisfactory**
- **Ink Is Not Ejected**

## Print Results Not Satisfactory

If the print result is not satisfactory due to white streaks, misaligned lines, or uneven colors, confirm the paper and print quality settings first.

### Check1 Do the page size and media type settings match the size and type of the loaded paper?

When these settings are incorrect, you cannot obtain a proper print result.

If you are printing a photograph or an illustration, incorrect paper type settings may reduce the quality of the printout color.

Also, if you print with an incorrect paper type setting, the printed surface may be scratched.

In borderless printing, uneven coloring may occur depending on the combination of the paper type setting and the loaded paper.

The method of confirming the paper and print quality settings differs depending on what you do with your printer.

To print from a PictBridge (Wireless LAN) compliant device	Confirm by using your PictBridge (Wireless LAN) compliant device. <a href="#">■ About PictBridge (Wireless LAN) Print Settings</a>
To print from a computer	Confirm by using the printer driver. <a href="#">■ Printing with Easy Setup</a>

### Check2 Make sure that the appropriate print quality is selected referring to the table in Check 1.

Select a print quality option suitable for the paper and image for printing. If you notice blurs or uneven colors, increase the print quality setting and try printing again.

#### ▶▶▶ Note

- You cannot make this setting from a PictBridge (Wireless LAN) compliant device.

### Check3 If the problem is not resolved, there may be other causes.

See also the sections below:

[■ Cannot Print to End of Job](#)

[■ No Printing Results/Printing Is Blurred/Colors Are Wrong/White Streaks](#)

[■ Lines Are Misaligned](#)

[■ Printed Paper Curls or Has Ink Blots](#)

[■ Paper Is Smudged/Printed Surface Is Scratched](#)

[■ Back of the Paper Is Smudged](#)

[■ Colors Are Uneven or Streaked](#)

## Cannot Print to End of Job

**Check** Is the space of your computer's hard disk sufficient?

Delete unnecessary files to free disk space.

# No Printing Results/Printing Is Blurred/Colors Are Wrong/White Streaks

❖ No Printing Results



❖ Printing Is Blurred

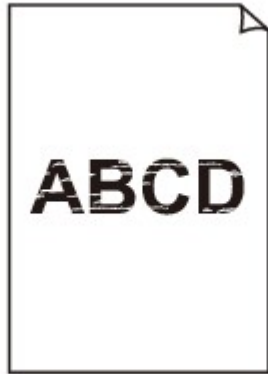

❖ Colors Are Wrong



❖ White Streaks

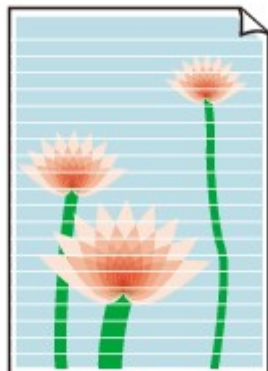

**Check1** Did you confirm the paper and print quality settings?

■ [Print Results Not Satisfactory](#)

**Check2** Print the Nozzle Check Pattern and perform any necessary maintenance operations such as Print Head Cleaning.

Print the Nozzle Check Pattern to determine whether the ink ejects properly from the print head nozzles.

Refer to [When Printing Becomes Faint or Colors Are Incorrect](#) for the Nozzle Check Pattern printing, Print Head Cleaning, and Print Head Deep Cleaning.

- If the Nozzle Check Pattern is not printed correctly:

Check to see if a particular color's ink tank is not empty.

If the Nozzle Check Pattern is not printed correctly though ink is sufficient, perform the Print Head Cleaning and try printing the Nozzle Check Pattern again.

- If the problem is not resolved after performing the Print Head Cleaning twice:

Perform the Print Head Deep Cleaning.

If the problem is not resolved after performing the Print Head Deep Cleaning, turn off the printer and perform another Print Head Deep Cleaning after 24 hours.

- If the problem is not resolved after performing the Print Head Deep Cleaning twice:

If Print Head Deep Cleaning does not resolve the problem, the print head may be damaged. Contact the service center.

**Check3** When an ink tank runs out of ink, replace it with a new one.

**Check4** When using paper with one printable surface, make sure that the paper is loaded with the printable side facing up.

Printing on the wrong side of such paper may cause unclear prints or prints with reduced quality.

Load paper with the printable side facing up.

Refer to the instruction manual supplied with the paper for detailed information on the printable side.



## Lines Are Misaligned



**Check1** Did you confirm the paper and print quality settings?

■ [Print Results Not Satisfactory](#)

**Check2** Perform Print Head Alignment.

If printed lines are misaligned or print results are otherwise unsatisfactory, adjust the print head position.

■ [Aligning the Print Head](#)

### ▶▶ Note

- If the problem is not resolved after performing the Print Head Alignment, perform Print Head Alignment manually referring to [Aligning the Print Head Position from Your Computer](#).

**Check3** Increase the print quality and try printing again.

Increasing the print quality in the printer driver may improve the print result.

# Printed Paper Curls or Has Ink Blots

## Printed Paper Has Ink Blots



## Printed Paper Curls



**Check1** Did you confirm the paper and print quality settings?

■ [Print Results Not Satisfactory](#)

**Check2** If the intensity is set high, reduce the intensity setting and try printing again.

If you are using plain paper to print images with high intensity, the paper may absorb too much ink and become wavy, causing paper abrasion.

You can confirm the intensity using the printer driver.

■ [Adjusting Intensity](#)

**Check3** Is Photo Paper used for printing photographs?

When printing data with high color saturation such as photographs or images in deep color, we recommend using Photo Paper Plus Glossy II or other Canon speciality paper.

■ [Media Types You Can Use](#)

## Paper Is Smudged/Printed Surface Is Scratched

### Paper Is Smudged

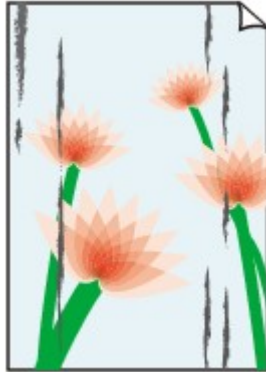
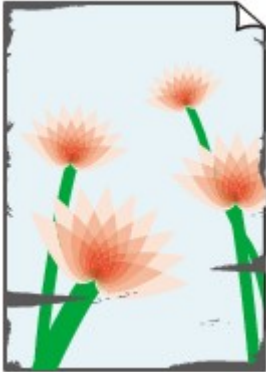

The Edges of Paper Are Smudged Printed Surface Is Smudged



### Printed Surface Is Scratched

**Check1** Did you confirm the paper and print quality settings?

 [Print Results Not Satisfactory](#)

**Check2** Is the appropriate type of paper used? Check the followings:

- Check to see if the paper you are printing on is suitable for your printing purpose.

 [Media Types You Can Use](#)

- When performing Borderless Printing, make sure that the paper you are using is suitable for Borderless Printing.

If the paper you are using is not suitable for Borderless Printing, the print quality may be reduced at the top and bottom edges of the paper.

 [Printing Area](#)

**Check3** Load the paper after correcting its curl.

We recommend putting unused paper back into the package and keeping it on a level surface.

- **For Plain Paper**

Turn the paper over and reload it to print on the other side.

Leaving the paper loaded on the rear tray for a long time may cause the paper to curl. In this case, load the paper with the other side facing up. It may resolve the problem.

- **For Other Paper**

If the curl on the four corners of the paper is more than 0.1 inch / 3 mm (A) in height, the paper may be smudged or may not be fed properly. In such cases, follow the procedure described below to correct the paper curl.



1. Roll up the paper in the opposite direction to the paper curl as shown below.

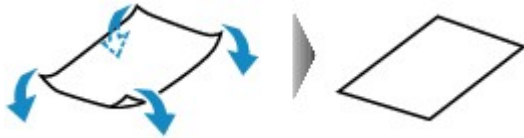

2. Check that the paper is now flat.

We recommend printing curl-corrected paper one sheet at a time.

### ▶▶▶ Note

- Depending on the media type, the paper may be smudged or may not be fed properly even if it is not curled inward. In such cases, follow the procedure described below to curl the paper outward within 0.1 inch / 3 mm (B) in height before printing. This may improve the print result.

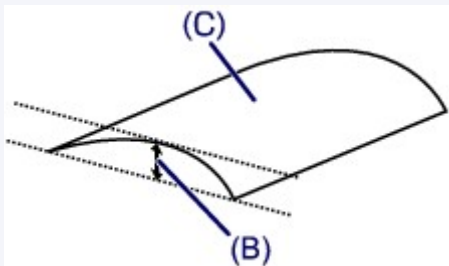

(C) Printing side

We recommend printing paper that has been curled outward one sheet at a time.

### Check4 Is the paper thickness lever set properly?

Adjust the position of the paper thickness lever properly according to the type of paper you are printing on.

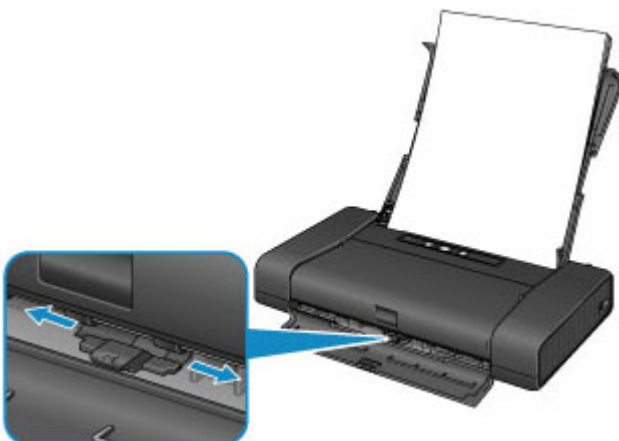

For details on how to load paper or the position of the paper thickness lever:

#### ■ [Loading Paper](#)

Depending on the printing content, the printing surface may become scratched or the corners or edges of the paper may become smudged even for the types of paper to set the lever to the right. In this case, set the paper thickness lever to the left.

Reset the paper thickness lever to the right when you finish printing. If the paper thickness lever is not set back to the right, the inside of the printer is more likely to get dirty due to the wider clearance between the print head and the loaded paper. It may also reduce print quality.

**Check5** If the intensity is set high, reduce the intensity setting and try printing again.

If you are using plain paper to print images with high intensity, the paper may absorb too much ink and become wavy, causing paper abrasion.

Reduce the intensity setting in the printer driver and try printing again.

1. Open the Print dialog.

■ [How to Open the Printer Driver Setup Window](#)

2. Select **Color Options** in the pop-up menu.
3. Drag the **Intensity** slide bar to set the intensity.

**Check6** Is printing performed beyond the recommended printing area?

If you are printing beyond the recommended printing area of your printing paper, the lower edge of the paper may become stained with ink.

Resize your original document in your application software.

■ [Printing Area](#)

**Check7** Is the paper feed roller dirty?

Clean the paper feed roller.

■ [Cleaning the Paper Feed Roller](#)

#### ▶▶▶ Note

- Cleaning the paper feed roller will wear the roller, so perform this procedure only when necessary.

**Check8** Is the inside of the printer dirty?

When performing duplex printing, the inside of the printer may become stained with ink, causing the printout to become smudged.

Perform the Bottom Plate Cleaning to clean the inside of the printer.

■ [Cleaning the Inside of the Printer \(Bottom Plate Cleaning\)](#)

#### ▶▶▶ Note

- To prevent the inside of the printer from stains, set the paper size correctly.

**Check9** Set the time to dry the printed surface longer.

Doing so gives the printed surface enough time to dry so that paper smudged and scratched are prevented.

1. Make sure that the printer is turned on.
2. Open the Canon IJ Printer Utility.

■ [Opening the Canon IJ Printer Utility](#)

3. Select **Custom Settings** in the pop-up menu.
4. Drag the **Ink Drying Wait Time:** slide bar to set the wait time, and then click **Apply**.
5. Confirm the message and click **OK**.

## Back of the Paper Is Smudged

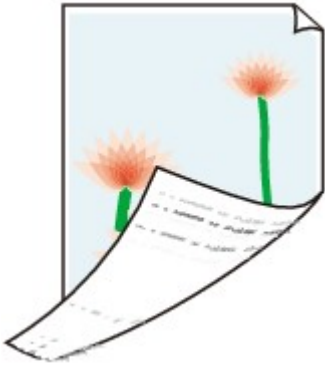

**Check1** Did you confirm the paper and print quality settings?

■ [Print Results Not Satisfactory](#)

**Check2** Perform the Bottom Plate Cleaning to clean the inside of the printer.

■ [Cleaning the Inside of the Printer \(Bottom Plate Cleaning\)](#)

### ▶▶ Note

- When performing borderless printing, duplex printing, or too much printing, the inside may become stained with ink.

# Colors Are Uneven or Streaked

## Colors Are Uneven



## Colors Are Streaked



**Check1** Did you confirm the paper and print quality settings?

■ [Print Results Not Satisfactory](#)

**Check2** Print the Nozzle Check Pattern and perform any necessary maintenance operations such as Print Head Cleaning.

Print the Nozzle Check Pattern to determine whether the ink ejects properly from the print head nozzles.

Refer to [When Printing Becomes Faint or Colors Are Incorrect](#) for the Nozzle Check Pattern printing, Print Head Cleaning, and Print Head Deep Cleaning.

- If the Nozzle Check Pattern is not printed correctly:

Check to see if a particular color's ink tank is not empty.

If the Nozzle Check Pattern is not printed correctly though ink is sufficient, perform the Print Head Cleaning and try printing the Nozzle Check Pattern again.

- If the problem is not resolved after performing the Print Head Cleaning twice:

Perform the Print Head Deep Cleaning.

If the problem is not resolved after performing the Print Head Deep Cleaning, turn off the printer and perform another Print Head Deep Cleaning after 24 hours.

- If the problem is not resolved after performing the Print Head Deep Cleaning twice:

If Print Head Deep Cleaning does not resolve the problem, the print head may be damaged. Contact the service center.

**Check3** Perform Print Head Alignment.

■ [Aligning the Print Head](#)

▶▶ **Note**

- If the problem is not resolved after performing the Print Head Alignment, perform Print Head Alignment manually referring to [Aligning the Print Head Position from Your Computer](#).



# Ink Is Not Ejected

## Check1 Has the ink run out?

Open the print head cover, then check the status of ink lamp.

### [■Checking the Ink Status](#)

## Check2 Are the print head nozzles clogged?

Print the Nozzle Check Pattern to determine whether the ink ejects properly from the print head nozzles.

Refer to [When Printing Becomes Faint or Colors Are Incorrect](#) for the Nozzle Check Pattern printing, Print Head Cleaning, and Print Head Deep Cleaning.

- If the Nozzle Check Pattern is not printed correctly:

Check to see if a particular color's ink tank is not empty.

If the Nozzle Check Pattern is not printed correctly though ink is sufficient, perform the Print Head Cleaning and try printing the Nozzle Check Pattern again.

- If the problem is not resolved after performing the Print Head Cleaning twice:

Perform the Print Head Deep Cleaning.

If the problem is not resolved after performing the Print Head Deep Cleaning, turn off the printer and perform another Print Head Deep Cleaning after 24 hours.

- If the problem is not resolved after performing the Print Head Deep Cleaning twice:

If Print Head Deep Cleaning does not resolve the problem, the print head may be damaged. Contact the service center.

## **Problems with the Printer**

- **The Printer Cannot Be Powered On**
- **The Printer Turns Off Unintentionally**
- **Cannot Connect to Computer with a USB Cable Properly**
- **Cannot Communicate with the Printer with USB Connection**
- **Print Head Holder Does Not Move to the Position for Replacing**

## The Printer Cannot Be Powered On

**Check1** Press the **ON** button.

**Check2** Make sure that the power plug is securely plugged into the power cord connector of the printer, then turn it back on.

**Check3** Unplug the printer from the power supply, then plug the printer back in and turn the printer back on after leaving it for at least 2 minutes.

**Check4** If you use a battery, check the remaining level of the battery.

For details on how to check it, refer to the battery's instruction manual.

If the battery is running out, replace the battery with a charged one, or connect the AC adapter to the printer.

If the problem is not resolved, contact the service center.

## The Printer Turns Off Unintentionally

**Check** Deactivate the setting to turn the unit off automatically.

The printer turns off automatically according to the elapsed time you specified if you activate the setting to turn the unit off automatically.

If you do not want the printer to turn off automatically, open Canon IJ Printer Utility, select **Power Settings** in the pop-up menu, then select **Disable** for **Using AC Adapter:** in **Auto Power Off** on **Auto Power**.

# Cannot Connect to Computer with a USB Cable Properly

## Printing Speed Is Slow/Hi-Speed USB Connection Does Not Work

If your system environment is not fully compatible with Hi-Speed USB, the printer will operate at a lower speed provided under USB 1.1. In this case, the printer operates properly but printing speed may slow down due to communication speed.

**Check** Check the following to make sure that your system environment supports Hi-Speed USB connection.

- Does the USB port on your computer support Hi-Speed USB connection?
- Does the USB cable or the USB hub support Hi-Speed USB connection?

Be sure to use a certified Hi-Speed USB cable. We recommend that the cable is no longer than around 10 feet / 3 meters.

- Does the operating system of your computer support Hi-Speed USB connection?

Obtain and install the latest update for your computer.

- Does the Hi-Speed USB driver operate properly?

Obtain the latest version of the Hi-Speed USB driver compatible with your hardware and reinstall it on your computer.

### **»» Important**

- For details on Hi-Speed USB of your system environment, contact the manufacturer of your computer, USB cable, or USB hub.

## Cannot Communicate with the Printer with USB Connection

**Check1** Make sure that the printer is turned on.

**Check2** Make sure that the USB cable is connected properly.

See [Connecting the Printer to the Computer Using a USB Cable](#) to connect the USB cable properly.

**Check3** Do not start up IJ Network Tool while printing.

**Check4** Do not print while IJ Network Tool is running.

# Print Head Holder Does Not Move to the Position for Replacing

## Check1 Is the **POWER** lamp off?

Check if the **POWER** lamp is lit.

The print head holder will not move unless the power is on. If the **POWER** lamp is off, close the print head cover and turn the printer on.

## Check2 Is the **Alarm** lamp flashing?

Close the print head cover, confirm the number of times the **Alarm** lamp is flashing, take the appropriate action to resolve the error, and then reopen it. For details on how to resolve the error, see [Support Code List](#).

## Check3 Has the print head cover been left open for 10 minutes or longer?

If the print head cover is left open for more than 10 minutes, the print head holder moves to the position to protect it to prevent the print head from drying out. Close and reopen the print head cover to return the print head holder to the position for replacing.

## Check4 Has the printer been printing continuously for a long period?

Close the print head cover, wait a while, then reopen it.

If the printer has been printing continuously for a long time, the print head holder may not move to the position for replacing since the print head may overheat.

### **Note**

- Opening the print head cover while printing moves the print head holder to the position to protect it. Close the print head cover, and reopen it after printing finishes.

## Problems with Installation/Downloading

- ▶ [Cannot Install the Printer Driver](#)
- ▶ [Uninstalling IJ Network Tool](#)



## **Cannot Install the Printer Driver**

Download the driver from the support page of our website, then reinstall it.

# Uninstalling IJ Network Tool

Follow the procedure below to uninstall IJ Network Tool from your computer.

## ▶▶ Important

- Even if IJ Network Tool is uninstalled, you can print over network. However, you cannot change the network settings over network.

1. Select **Applications** from the **Go** menu of Finder, double-click **Canon Utilities > IJ Network Tool**, drag the **Canon IJ Network Tool** icon into the **Trash**.

2. Restart the computer.

Empty the **Trash** and restart your computer.

## ▶▶ Note

- To reinstall IJ Network Tool, uninstall IJ Network Tool, then install it again from our website.

## **About Errors/Messages Displayed**

- ▶ **If an Error Occurs**
- ▶ **A Message Is Displayed**
- ▶ **Error Message Appears on a PictBridge (Wireless LAN) Compliant Device**

## If an Error Occurs

When an error occurs in printing such as the printer is out of paper or paper is jammed, a troubleshooting message is displayed automatically. Take the appropriate action described in the message.

When an error occurs, the **Alarm** lamp flashes and a Support Code (error number) is displayed on the computer screen. For some errors, the **POWER** lamp and the **Alarm** lamp flashes alternately. Check the status of the lamps and the message, then take the appropriate action to resolve the error.

### Support Code Corresponding to the Number of Flashes of the Alarm Lamp

Example of 2 times flashing:

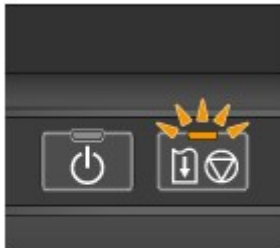

(A) Flashes

(B) Goes off

Number of flashes	Cause	Support Code
2 flashes	There is no paper in the rear tray.	<a href="#">1000</a>
	The paper size in the print settings and the size of the loaded paper do not match.	<a href="#">2100</a> , <a href="#">2101</a>
3 flashes	Paper is jammed in the paper output slot or in the rear tray.	<a href="#">1300</a>
4 flashes	If the lamp on the ink tank is flashing, ink may have run out.	<a href="#">1600</a>
	The ink tank is not installed.	<a href="#">1660</a>
	The print head lock lever is not locked or an ink tank is installed improperly.	<a href="#">1687</a>
5 flashes	The print head may be damaged.	<a href="#">1401</a> , <a href="#">1403</a> , <a href="#">1405</a>
7 flashes	More than one ink tanks of the same color are installed. (The lamp on the ink tank flashes.)	<a href="#">1681</a>
8 flashes	The ink absorber is almost full.	<a href="#">1700</a> , <a href="#">1701</a>
11 flashes	Automatic Print Head Alignment failed.	<a href="#">2500</a>
	Cannot perform printing with the current print setting.	<a href="#">4103</a>
12 flashes	Battery has exhausted.	<a href="#">1810</a>
15 flashes	The ink tank cannot be recognized.	<a href="#">1410</a> , <a href="#">1411</a>

17 flashes	The ink has run out. (The lamp on the ink tank flashes.)	<a href="#">1688</a>
18 flashes	The remaining ink level cannot be correctly detected.	<a href="#">1689</a>
21 flashes	The printer cannot detect the paper size.	<a href="#">2103</a>

## Support Code Corresponding to the Number of Alternate Flashes of the POWER Lamp and the Alarm Lamp

Example of 2 times flashing:

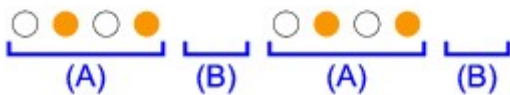

(A) Flashes

(B) Goes off

Number of flashes	Cause	Support Code
2 flashes	Printer error has occurred.	<a href="#">5100</a>
7 flashes	Printer error has occurred.	<a href="#">5B00</a> , <a href="#">5B01</a>
10 flashes	An error requiring you to contact the service center has occurred.	<a href="#">B201</a> , <a href="#">B202</a> , <a href="#">B203</a> , <a href="#">B204</a>
16 flashes	A problem has occurred with the battery.	<a href="#">A100</a>
Other cases than above	Printer error has occurred.	<a href="#">5200</a> , <a href="#">5400</a> , <a href="#">5700</a> , <a href="#">5C00</a> , <a href="#">6000</a> , <a href="#">6500</a> , <a href="#">6800</a> , <a href="#">6801</a> , <a href="#">6900</a> , <a href="#">6901</a> , <a href="#">6902</a> , <a href="#">6910</a> , <a href="#">6911</a> , <a href="#">6930</a> , <a href="#">6931</a> , <a href="#">6932</a> , <a href="#">6933</a> , <a href="#">6940</a> , <a href="#">6941</a> , <a href="#">6942</a> , <a href="#">6943</a> , <a href="#">6944</a> , <a href="#">6945</a> , <a href="#">6946</a> , <a href="#">6A00</a> , <a href="#">A000</a>

- When a Support Code and a message are displayed on the computer screen:



\* The screen differs depending on the OS you are using.

## »» Note

- You can confirm the actions against errors with Support Codes on your computer by searching a Support Code.

■ [Click Here to Search](#)

For details on how to resolve errors without Support Codes, see [A Message Is Displayed](#).

## A Message Is Displayed

This section describes some of the errors or messages.

### ►► Note

- A Support Code (error number) is displayed on the computer for some error or message. For details on errors with Support Codes, refer to [Support Code List](#).

## The Inkjet Printer/Scanner/Fax Extended Survey Program Icon Appears

If the Inkjet Printer/Scanner/Fax Extended Survey Program is installed, the printer and application software usage information is scheduled to be sent every month for about ten years. The **Inkjet Printer/Scanner/Fax Extended Survey Program** icon appears in the Dock when it is time to send the printer usage information.

Read the instructions on the screen after clicking the icon, then follow the procedure below.

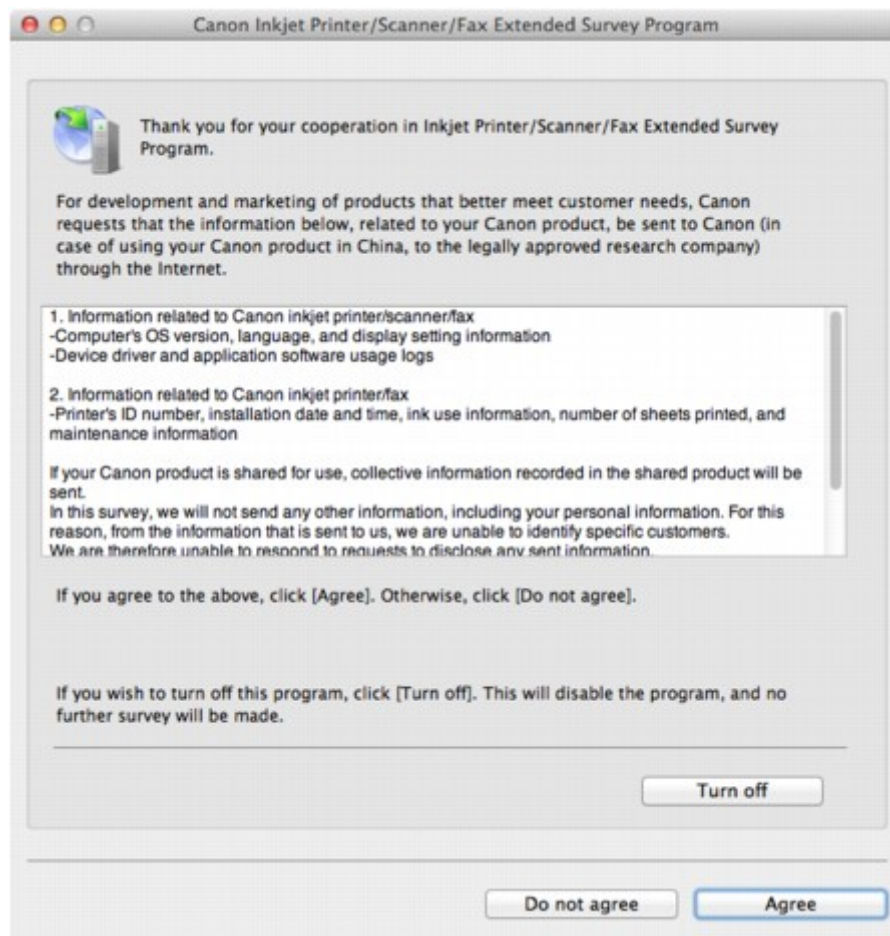

- **If you agree to participate in the survey program:**

Click **Agree**, then follow the on-screen instructions. The printer usage information will be sent via the Internet. If you have followed the on-screen instructions, the information will be sent automatically from the second time onward and the confirmation screen will not be displayed again.

### ►► Note

- If you deselect the **Send automatically from the next time** check box, the information will not be sent automatically from the second time onward and the **Inkjet Printer/Scanner/Fax Extended Survey Program** icon will appear in the Dock at the time of the next survey.

- **If you do not agree to participate in the survey program:**

Click **Do not agree**. The confirmation screen will be closed, and the survey at that time is skipped. The confirmation screen will be displayed again one month later.

- **To stop sending the information:**

Click **Turn off**. The Inkjet Printer/Scanner/Fax Extended Survey Program is stopped, and the information will not be sent. To resume the survey, see [Changing the setting:](#).

- **To uninstall the Inkjet Printer/Scanner/Fax Extended Survey Program:**

1. Stop the Inkjet Printer/Scanner/Fax Extended Survey Program.

- [Changing the setting:](#)

2. Select **Applications** from the **Go** menu of Finder, and double-click the **Canon Utilities** folder, then the **Inkjet Extended Survey Program** folder.
3. Place the **Canon Inkjet Printer/Scanner/Fax Extended Survey Program.app** file into the **Trash**.
4. Restart the computer.  
Empty the **Trash** and restart your computer.

- **Changing the setting:**

To display the confirmation screen every time the printer usage information is sent or to resume surveying, follow the procedure below.

1. Select **Applications** from the **Go** menu of Finder, and double-click the **Canon Utilities** folder, then the **Inkjet Extended Survey Program** folder.
2. Double-click the Canon Inkjet Printer/Scanner/Fax Extended Survey Program icon.

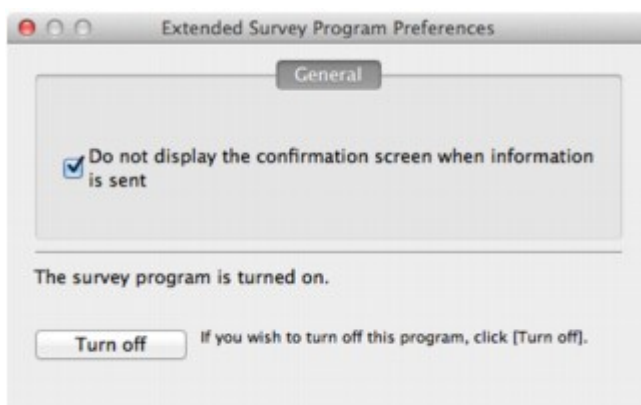

- **Do not display the confirmation screen when information is sent:**

If the check box is selected, the information will be sent automatically.

If the check box is not selected, the **Inkjet Printer/Scanner/Fax Extended Survey Program** icon will appear in the Dock at the time of the next survey. Click the icon, then follow the on-screen instructions.

- **Turn off/Turn on** button:

Click the **Turn off** button to stop the Inkjet Printer/Scanner/Fax Extended Survey Program.

Click the **Turn on** button to restart the Inkjet Printer/Scanner/Fax Extended Survey Program.



## Error Message Appears on a PictBridge (Wireless LAN) Compliant Device

The following are the possible errors that may occur when printing directly from a PictBridge (Wireless LAN) compliant device and the countermeasures to clear them.

### ▶▶▶ Note

- This section describes errors that are indicated on Canon-brand PictBridge (Wireless LAN) compliant devices. The error messages and operations may vary depending on the device you are using. For errors on non-Canon PictBridge (Wireless LAN) compliant devices, check the status of the **Alarm** lamp and take the appropriate action to clear the error. For details, see [If an Error Occurs](#).
- For the errors indicated on the PictBridge (Wireless LAN) compliant device and their solution, also refer to the instruction manual of the device. For other troubles on the device, contact the manufacturer.

Error Message on the PictBridge (Wireless LAN) Compliant Device	Action
"Printer in use"	<p>If the printer is printing from the computer or warming up, wait until the job ends.</p> <p>When it is ready, the printer starts printing automatically.</p> <p>If the printer is not printing from the computer or warming up, check the number of how many the <b>Alarm</b> lamp flashes and take the appropriate action to resolve the error.</p> <p>■ <a href="#">If an Error Occurs</a></p>
"No paper"	<p>Load paper, and select <b>Continue</b>* in the display on your PictBridge (Wireless LAN) compliant device.</p> <p>* To resume printing, you can also press the <b>RESUME/CANCEL</b> button on the printer instead of selecting <b>Continue</b> on the device.</p>
"Paper Error"	<p>Check the number of how many the <b>Alarm</b> lamp flashes and take the appropriate action to resolve the error.</p> <p>■ <a href="#">If an Error Occurs</a></p>
"Paper jam"	<p>Select <b>Stop</b> in the display on your PictBridge (Wireless LAN) compliant device to stop printing.</p> <p>Remove the jammed paper, load new paper, press the <b>RESUME/CANCEL</b> button on the printer, then try printing again.</p>
"Printer cover open"	<p>Close the print head cover on the printer.</p>
"No print head"	<p>Check the number of how many the <b>Alarm</b> lamp flashes and take the appropriate action to resolve the error.</p> <p>■ <a href="#">If an Error Occurs</a></p>
"Waste tank full"/"Ink absorber full"	<p>The ink absorber is nearly full.</p> <p>Check the number of how many the <b>Alarm</b> lamp flashes and take the appropriate action to resolve the error.</p> <p>■ <a href="#">If an Error Occurs</a></p>
"No ink"/"Ink cassette error"	<p>Check the number of how many the <b>Alarm</b> lamp flashes and take the appropriate action to resolve the error.</p>

	<p>■ <a href="#">If an Error Occurs</a></p>
"Hardware Error"	<p>Check the number of how many the <b>Alarm</b> lamp flashes and take the appropriate action to resolve the error.</p> <p>■ <a href="#">If an Error Occurs</a></p>
"Printer error"	<p>An error requiring servicing may have occurred.</p> <p>Turn off the printer, and unplug the power cord of the printer from the power supply.</p> <p>If you use a battery, turn the printer off, then detach the battery.</p> <p>Plug the printer back in or attach the battery, then turn the printer back on.</p> <p>If the problem is not resolved, contact the service center.</p>

## If You Cannot Resolve the Problem

If you cannot resolve the problem with any of the workarounds in this chapter, please contact the seller of the printer or the service center.

Canon support staff are trained to be able to provide technical support to satisfy customers.

### **Caution**

- If the printer emits any unusual sound, smoke, or odor, turn it off immediately. Unplug the power cord from the outlet and contact the seller or the service center. Never attempt to repair or disassemble the printer yourself.
- Attempts by customers to repair or take apart the printer will invalidate any warranty regardless of whether the warranty has expired.

Before contacting the service center, confirm the following:

- Product name:
  - \* Your printer's name is located on the front cover of the setup manual.
- Serial number: please refer to the setup manual
- Details of the problem
- What you tried to solve the problem, and what happened

# Support Code List

The support code appears on the computer screen when an error occurs.

"Support Code" means the error number and appears with an error message.

When an error occurs, check the support code displayed on the computer screen and take the appropriate action.

## Support Code Appears on the Computer Screen

- **1000 to 1ZZZ**

[1000](#) [1200](#) [1300](#) [1401](#) [1403](#) [1405](#)

[1410](#) [1411](#) [1600](#) [1660](#) [1681](#) [1687](#)

[1688](#) [1689](#) [1700](#) [1701](#) [1810](#)

- **2000 to 2ZZZ**

[2100](#) [2101](#) [2103](#) [2500](#)

- **4000 to 4ZZZ**

[4103](#)

- **5000 to 5ZZZ**

[5100](#) [5200](#) [5400](#) [5700](#) [5B00](#) [5B01](#)

[5C00](#)

- **6000 to 6ZZZ**

[6000](#) [6500](#) [6800](#) [6801](#) [6900](#) [6901](#)

[6902](#) [6910](#) [6911](#) [6930](#) [6931](#) [6932](#)

[6933](#) [6940](#) [6941](#) [6942](#) [6943](#) [6944](#)

[6945](#) [6946](#) [6A00](#)

- **A000 to ZZZZ**

[A000](#) [A100](#) [B201](#) [B202](#) [B203](#) [B204](#)

About the support code for paper jam, you can also refer to [Support Code List \(When Paper Is Jammed\)](#).

## Support Code List (When Paper Is Jammed)

If the paper is jammed, remove it following the procedure appropriate for each case.

- If you can see the jammed paper at the paper output slot or the rear tray:

- [1300](#)

- If the paper tears and you cannot remove it from the paper output slot or from the rear tray:

- [Paper Is Jammed inside the Printer](#)

- Cases other than above:

- [In Other Cases](#)

# 1300

## Cause

Paper is jammed in the paper output slot or in the rear tray.

## Action

Remove the jammed paper following the procedure below.

### ►► Note

- If you need to turn off the printer to remove jammed paper during printing, press the **RESUME/CANCEL** button to cancel print jobs before turning off the printer.

1. Pull the paper out slowly, either from the rear tray or from the paper output slot, whichever is easier.

Hold the paper with your hands, then pull the paper out slowly not to tear it.



### ►► Note

- If you cannot pull the paper out, turn the printer off and turn it back on. The paper may be ejected automatically.
- If the paper tears and you cannot remove the jammed paper from the paper output slot or the rear tray, remove the paper from inside the printer.

■ [Paper Is Jammed inside the Printer](#)

2. Reload the paper, and press the **RESUME/CANCEL** button on the printer.

If you turned off the printer in step 1, all print jobs in the queue are canceled. Reprint if necessary.

### ►► Note

- When reloading the paper, confirm that you are using the paper suited for printing and are loading it correctly.
- We recommend you use paper other than A5 sized one to print documents with photos or graphics; otherwise, the printout may curl and cause paper exit jams.

If you cannot remove the paper or the paper tears inside the printer, or if the paper jam error continues after removing the paper, contact the service center.

## Paper Is Jammed inside the Printer

If the jammed paper tears and you cannot remove the paper either from the paper output slot or from the rear tray, or if the jammed paper remains inside the printer, remove the paper following the procedure below.

### ►► Note

- If you need to turn off the printer to remove jammed paper during printing, press the **RESUME/CANCEL** button to cancel print jobs before turning off the printer.

1. Turn off the printer, and unplug the power cord of the printer from the power supply.  
If you use a battery, turn off the printer, then detach the battery.

2. Open the print head cover.

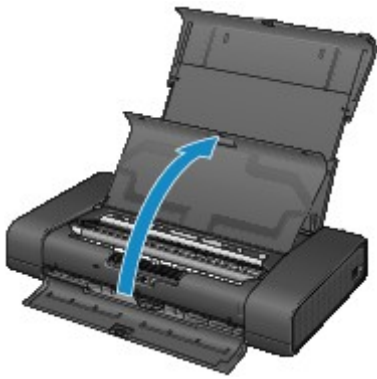

3. Make sure that the jammed paper is not under the print head holder.

If the jammed paper is under the print head holder, move the print head holder to the right edge or the left edge whichever is easier to remove the paper.

When you move the print head holder, press either the right side or the left side of the print head holder with your fingertips and slide the print head holder slowly to the right edge or the left edge.

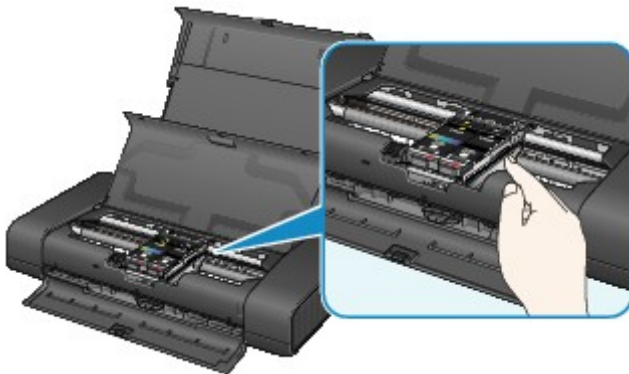

### ►► Important

- When you move the print head holder, do not touch the print head lock lever.

4. Hold the jammed paper with your hands.



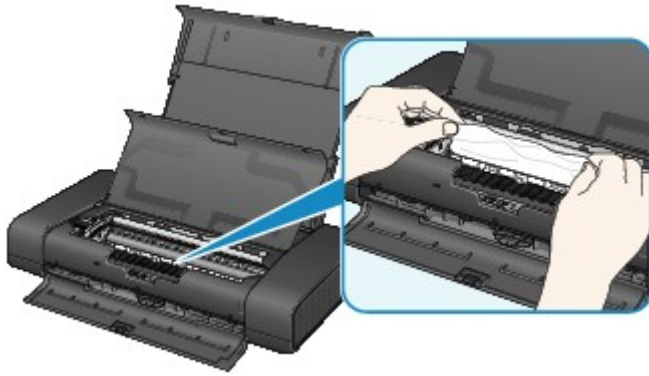

If the paper is rolled up, pull it out.

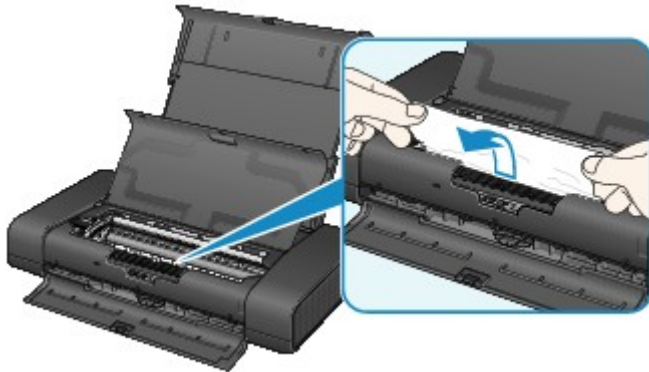

5. Pull the paper slowly not to tear it, then pull the paper out.

Keep an angle of the paper about 45 degrees and pull it slowly.

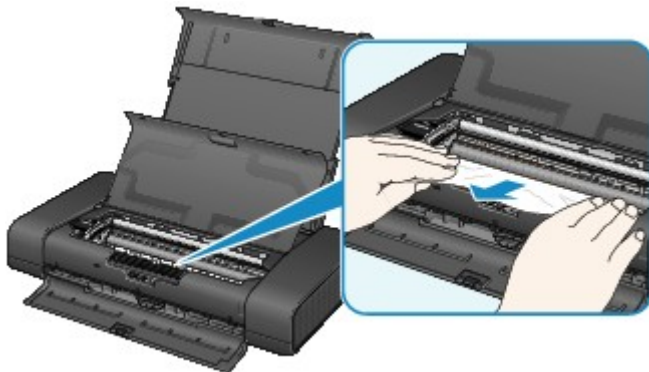

6. Make sure that all the jammed paper is removed.

If the paper is torn, a piece of paper may remain inside the printer. Check the following and remove the piece of paper if it remains.

- Does the piece of paper remain under the print head holder?
- Does the little piece of paper remain inside the printer?
- Does the piece of paper remain in the right side or the left side space (A) inside the printer?

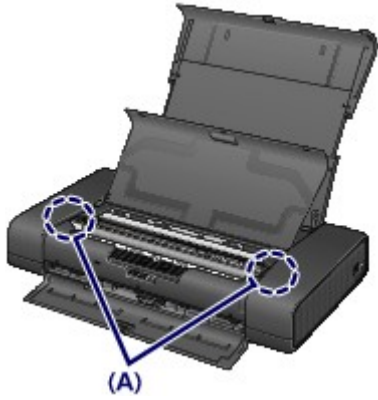

7. Close the print head cover.

All print jobs in the queue are canceled. Reprint if necessary.

**▶▶▶ Note**

- When reloading the paper, confirm that you are using the paper suited for printing and are loading it correctly. If the message about paper jam is displayed on the computer screen when you resume printing after removing all the jammed paper, a piece of paper may remain inside the printer. In this case, confirm that no piece of paper remains inside the printer.

If you cannot remove the paper or the paper tears inside the printer, or if the paper jam error continues after removing the paper, contact the service center.

## In Other Cases

Make sure of the following:

**Check1** Are there any foreign objects around the paper output slot?

**Check2** Are there any foreign objects in the rear tray?



If there are any foreign objects in the rear tray, be sure to turn off the printer, unplug it from the power supply, then remove the foreign object.

If you use a battery, turn off the printer, detach the battery, then remove the foreign object.



**Check3** Is the paper curled?

Load the paper after correcting its curl.

# 1000

## Cause

There is no paper in the rear tray.

## Action

Load paper in the rear tray and press the printer's **RESUME/CANCEL** button.

## 1200

### Cause

The print head cover is open.

### Action

Close the print head cover and wait for a while.

Do not close it while you are replacing an ink tank.

### Important

- When you replace the ink tank, do not touch the print head lock lever.

## **1401**

### **Cause**

The print head may be damaged.

### **Action**

Contact the service center.

## **1403**

### **Cause**

The print head may be damaged.

### **Action**

Contact the service center.

## **1405**

### **Cause**

The print head may be damaged.

### **Action**

Contact the service center.



## 1410

### **Cause**

The ink tank cannot be recognized.

### **Action**

Open the print head cover and check that the ink tank which lamp is off is installed properly.

If the front (innermost) part of the ink tank is sticking up, push down on the "Canon" logo on the ink tank to install it properly.

If the ink lamp is off even though the ink tank is installed properly, replace the ink tank.

# 1411

## **Cause**

The ink tank cannot be recognized.

## **Action**

Open the print head cover and check that the ink tank which lamp is off is installed properly.

If the front (innermost) part of the ink tank is sticking up, push down on the "Canon" logo on the ink tank to install it properly.

If the ink lamp is off even though the ink tank is installed properly, replace the ink tank.

# 1600

## Cause

If the lamp on the ink tank is flashing, ink may have run out.

## Action

Replacing the ink tank is recommended.

If printing is in progress and you want to continue printing, press the printer's **RESUME/CANCEL** button with the ink tank installed. Then printing can continue. Replacing the ink tank is recommended after the printing. The printer may be damaged if printing is continued under the ink out condition.

### ▶▶ Note

- If multiple ink lamps are flashing red, check the status of each ink tank.

## **1660**

### **Cause**

The ink tank is not installed.

### **Action**

Install the ink tank.

## 1681

### **Cause**

More than one ink tanks of the same color are installed. (The lamp on the ink tank flashes.)

### **Action**

Confirm that the ink tanks are installed in the appropriate positions.

## 1687

### Cause

The print head lock lever is not locked or an ink tank is installed improperly.

### Action

Open the print head cover, then take the corresponding actions below.

- Make sure that the ink tank is installed properly.

Push the ink tank until it clicks into place.

If the front (innermost) part of the ink tank is sticking up, push down on the "Canon" logo on the ink tank.

- There are the right and left tabs on the print head lock lever. Push both tabs of the print head lock lever and make sure that both tabs are locked securely.

Push both tabs of the print head lock lever until each clicks into place.

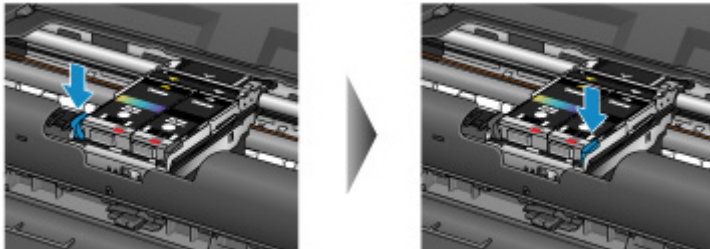

Push in the order of the left and right lever.

After taking the corresponding actions, close the print head cover.

# 1688

## Cause

Ink has run out. (The lamp on the ink tank flashes.)

## Action

Replace the ink tank and close the print head cover.

Printing under the current condition may damage the printer.

If you want to continue printing in this condition, you need to release the function for detecting the remaining ink level. Press and hold the printer's **RESUME/CANCEL** button for at least 5 seconds, and then release it.

With this operation, releasing the function for detecting the remaining ink level is memorized. Please be advised that Canon shall not be liable for any malfunction or trouble which may be caused by continuation of printing under the ink out condition.

# 1689

## Cause

The remaining ink level cannot be correctly detected.

## Action

Replace the ink tank and close the print head cover.

Printing with an ink tank that was once empty may damage the printer.

If you want to continue printing in this condition, you need to release the function for detecting the remaining ink level. Press and hold the printer's **RESUME/CANCEL** button for at least 5 seconds, and then release it.

With this operation, releasing the function for detecting the remaining ink level is memorized. Please be advised that Canon shall not be liable for any machine malfunction or damage caused by refilled ink tanks.



## 1700

### Cause

The ink absorber is almost full.

### Action

Press the printer's **RESUME/CANCEL** button to continue printing. Contact the service center.

## 1701

### **Cause**

The ink absorber is almost full.

### **Action**

Press the printer's **RESUME/CANCEL** button to continue printing. Contact the service center.

## 1810

### **Cause**

Battery has exhausted.

### **Action**

If printing is in progress, cancel printing.

Turn off the printer, then either change to a fully charged battery pack or detach the battery attachment and connect the supplied AC adapter to the printer.

## 2100

### Cause

The paper size in the print settings and the size of the loaded paper do not match.

### Action

Check the print settings and the loaded paper, load paper of the correct size, then press the printer's **RESUME/CANCEL** button.

If you want to cancel printing, press the printer's **RESUME/CANCEL** button again while the **POWER** lamp is flashing.

## 2101

### Cause

The paper size in the print settings and the size of the loaded paper do not match.

### Action

Check the print settings and the loaded paper, load paper of the correct size, then press the printer's **RESUME/CANCEL** button.

If you want to cancel printing, press the printer's **RESUME/CANCEL** button again while the **POWER** lamp is flashing.

## 2103

### Cause

The printer cannot detect the paper size.

### Action

Press the printer's **RESUME/CANCEL** button to dismiss the error, then try to print again.

If this error still occurs even after printing again, set the printer not to detect the paper width by using the printer driver or Remote UI.

### ▶▶ Note

- Depending on the type of paper, the printer may not detect the paper width.

Additionally, if the print head cover is opened while printing is in progress, the printer may not detect the paper width.

## 2500

### Cause

The cause of following may have occurred the failure of Automatic Print Head Alignment.

- Print head nozzles are clogged.
- The paper of size other than A4 or Letter is loaded.
- The paper output slot is exposed to strong light.

### Action

Press the printer's **RESUME/CANCEL** button to dismiss the error, then take the actions described below.

- Print the nozzle check pattern to check the status of the print head.
- Load a sheet of A4/Letter-sized Canon Matte Photo Paper MP-101 and perform Automatic Print Head Alignment again.
- Adjust your operating environment and/or the position of the printer so that the paper output slot is not exposed directly to strong light.

After carrying out the above measures, if the problem continues after aligning the print head again, press the printer's **RESUME/CANCEL** button to dismiss the error, and then perform Manual Print Head Alignment.

## 4103

### **Cause**

Cannot perform printing with the current print settings.

### **Action**

Press the printer's **RESUME/CANCEL** button, to cancel printing.

Then change the print settings and print again.



# 5100

## Cause

Printer error has occurred.

## Action

Cancel printing and turn off the printer.

Then confirm the following.

- Confirm that there are no materials (e.g. jammed paper) that is preventing the print head holder from moving.

If any, remove the materials.

- Confirm that The print head lock lever is locked securely.

Push the right and left tabs of the print head lock lever until each clicks into place.

- Confirm that the ink tanks are installed properly.

Push an ink tank until it clicks into place.

After confirming the conditions above, turn on the printer again.

If the problem is not resolved, contact the service center.

## ►► Important

- When you clear the jammed paper or protective material that is preventing the print head holder from moving, be careful not to touch the components inside the printer. The printer may not print out properly if you touch it.

## **5200**

### **Cause**

Printer error has occurred.

### **Action**

Turn off the printer, and unplug the power cord of the printer from the power supply.

If you use a battery, turn off the printer, then detach the battery.

Plug the printer back in or attach the battery, then turn the printer back on.

If the problem is not resolved, contact the service center.

## **5400**

### **Cause**

Printer error has occurred.

### **Action**

Turn off the printer, and unplug the power cord of the printer from the power supply.

If you use a battery, turn off the printer, then detach the battery.

Plug the printer back in or attach the battery, then turn the printer back on.

If the problem is not resolved, contact the service center.

## **5700**

### **Cause**

Printer error has occurred.

### **Action**

Turn off the printer, and unplug the power cord of the printer from the power supply.

If you use a battery, turn off the printer, then detach the battery.

Plug the printer back in or attach the battery, then turn the printer back on.

If the problem is not resolved, contact the service center.

## **5B00**

### **Cause**

Printer error has occurred.

### **Action**

Contact the service center.

## **5B01**

### **Cause**

Printer error has occurred.

### **Action**

Contact the service center.

## **5C00**

### **Cause**

Printer error has occurred.

### **Action**

Turn off the printer, and unplug the power cord of the printer from the power supply.

If you use a battery, turn off the printer, then detach the battery.

Plug the printer back in or attach the battery, then turn the printer back on.

If the problem is not resolved, contact the service center.

## **6000**

### **Cause**

Printer error has occurred.

### **Action**

Turn off the printer, and unplug the power cord of the printer from the power supply.

If you use a battery, turn off the printer, then detach the battery.

Plug the printer back in or attach the battery, then turn the printer back on.

If the problem is not resolved, contact the service center.



## **6500**

### **Cause**

Printer error has occurred.

### **Action**

Turn off the printer, and unplug the power cord of the printer from the power supply.

If you use a battery, turn off the printer, then detach the battery.

Plug the printer back in or attach the battery, then turn the printer back on.

If the problem is not resolved, contact the service center.

## **6800**

### **Cause**

Printer error has occurred.

### **Action**

Turn off the printer, and unplug the power cord of the printer from the power supply.

If you use a battery, turn off the printer, then detach the battery.

Plug the printer back in or attach the battery, then turn the printer back on.

If the problem is not resolved, contact the service center.

## **6801**

### **Cause**

Printer error has occurred.

### **Action**

Turn off the printer, and unplug the power cord of the printer from the power supply.

If you use a battery, turn off the printer, then detach the battery.

Plug the printer back in or attach the battery, then turn the printer back on.

If the problem is not resolved, contact the service center.

## **6900**

### **Cause**

Printer error has occurred.

### **Action**

Turn off the printer, and unplug the power cord of the printer from the power supply.

If you use a battery, turn off the printer, then detach the battery.

Plug the printer back in or attach the battery, then turn the printer back on.

If the problem is not resolved, contact the service center.

## **6901**

### **Cause**

Printer error has occurred.

### **Action**

Turn off the printer, and unplug the power cord of the printer from the power supply.

If you use a battery, turn off the printer, then detach the battery.

Plug the printer back in or attach the battery, then turn the printer back on.

If the problem is not resolved, contact the service center.

## **6902**

### **Cause**

Printer error has occurred.

### **Action**

Turn off the printer, and unplug the power cord of the printer from the power supply.

If you use a battery, turn off the printer, then detach the battery.

Plug the printer back in or attach the battery, then turn the printer back on.

If the problem is not resolved, contact the service center.

## **6910**

### **Cause**

Printer error has occurred.

### **Action**

Turn off the printer, and unplug the power cord of the printer from the power supply.

If you use a battery, turn off the printer, then detach the battery.

Plug the printer back in or attach the battery, then turn the printer back on.

If the problem is not resolved, contact the service center.

## 6911

### **Cause**

Printer error has occurred.

### **Action**

Turn off the printer, and unplug the power cord of the printer from the power supply.

If you use a battery, turn off the printer, then detach the battery.

Plug the printer back in or attach the battery, then turn the printer back on.

If the problem is not resolved, contact the service center.



## **6930**

### **Cause**

Printer error has occurred.

### **Action**

Turn off the printer, and unplug the power cord of the printer from the power supply.

If you use a battery, turn off the printer, then detach the battery.

Plug the printer back in or attach the battery, then turn the printer back on.

If the problem is not resolved, contact the service center.

## 6931

### **Cause**

Printer error has occurred.

### **Action**

Turn off the printer, and unplug the power cord of the printer from the power supply.

If you use a battery, turn off the printer, then detach the battery.

Plug the printer back in or attach the battery, then turn the printer back on.

If the problem is not resolved, contact the service center.

## 6932

### **Cause**

Printer error has occurred.

### **Action**

Turn off the printer, and unplug the power cord of the printer from the power supply.

If you use a battery, turn off the printer, then detach the battery.

Plug the printer back in or attach the battery, then turn the printer back on.

If the problem is not resolved, contact the service center.

## **6933**

### **Cause**

Printer error has occurred.

### **Action**

Turn off the printer, and unplug the power cord of the printer from the power supply.

If you use a battery, turn off the printer, then detach the battery.

Plug the printer back in or attach the battery, then turn the printer back on.

If the problem is not resolved, contact the service center.

## **6940**

### **Cause**

Printer error has occurred.

### **Action**

Turn off the printer, and unplug the power cord of the printer from the power supply.

If you use a battery, turn off the printer, then detach the battery.

Plug the printer back in or attach the battery, then turn the printer back on.

If the problem is not resolved, contact the service center.

## **6941**

### **Cause**

Printer error has occurred.

### **Action**

Turn off the printer, and unplug the power cord of the printer from the power supply.

If you use a battery, turn off the printer, then detach the battery.

Plug the printer back in or attach the battery, then turn the printer back on.

If the problem is not resolved, contact the service center.

## 6942

### **Cause**

Printer error has occurred.

### **Action**

Turn off the printer, and unplug the power cord of the printer from the power supply.

If you use a battery, turn off the printer, then detach the battery.

Plug the printer back in or attach the battery, then turn the printer back on.

If the problem is not resolved, contact the service center.

## **6943**

### **Cause**

Printer error has occurred.

### **Action**

Turn off the printer, and unplug the power cord of the printer from the power supply.

If you use a battery, turn off the printer, then detach the battery.

Plug the printer back in or attach the battery, then turn the printer back on.

If the problem is not resolved, contact the service center.



## **6944**

### **Cause**

Printer error has occurred.

### **Action**

Turn off the printer, and unplug the power cord of the printer from the power supply.

If you use a battery, turn off the printer, then detach the battery.

Plug the printer back in or attach the battery, then turn the printer back on.

If the problem is not resolved, contact the service center.

## **6945**

### **Cause**

Printer error has occurred.

### **Action**

Turn off the printer, and unplug the power cord of the printer from the power supply.

If you use a battery, turn off the printer, then detach the battery.

Plug the printer back in or attach the battery, then turn the printer back on.

If the problem is not resolved, contact the service center.

## **6946**

### **Cause**

Printer error has occurred.

### **Action**

Turn off the printer, and unplug the power cord of the printer from the power supply.

If you use a battery, turn off the printer, then detach the battery.

Plug the printer back in or attach the battery, then turn the printer back on.

If the problem is not resolved, contact the service center.

## **6A00**

### **Cause**

Printer error has occurred.

### **Action**

Turn off the printer, and unplug the power cord of the printer from the power supply.

If you use a battery, turn off the printer, then detach the battery.

Plug the printer back in or attach the battery, then turn the printer back on.

If the problem is not resolved, contact the service center.

## **A000**

### **Cause**

Printer error has occurred.

### **Action**

Turn off the printer, and unplug the power cord of the printer from the power supply.

If you use a battery, turn off the printer, then detach the battery.

Plug the printer back in or attach the battery, then turn the printer back on.

If the problem is not resolved, contact the service center.

## **A100**

### **Cause**

A problem has occurred with the battery.

### **Action**

Cancel printing, then turn off the printer.

Either replace the battery pack or detach the battery attachment and connect the supplied AC adapter to the printer.

Plug the printer back in and turn the printer back on.

If the problem is not resolved, contact the service center.

## **B201**

### **Cause**

An error requiring you to contact the service center has occurred.

### **Action**

Turn off the printer, and unplug the power cord of the printer from the power supply.

If you use a battery, turn off the printer, then detach the battery.

Contact the service center.

## **B202**

### **Cause**

An error requiring you to contact the service center has occurred.

### **Action**

Turn off the printer, and unplug the power cord of the printer from the power supply.

If you use a battery, turn off the printer, then detach the battery.

Contact the service center.



## **B203**

### **Cause**

An error requiring you to contact the service center has occurred.

### **Action**

Turn off the printer, and unplug the power cord of the printer from the power supply.

If you use a battery, turn off the printer, then detach the battery.

Contact the service center.

## **B204**

### **Cause**

An error requiring you to contact the service center has occurred.

### **Action**

Turn off the printer, and unplug the power cord of the printer from the power supply.

If you use a battery, turn off the printer, then detach the battery.

Contact the service center.