



# HP Officejet 6200 series all-in-one

## User Guide



HP Officejet 6200 series all-in-one



## **User Guide**

© Copyright 2004 Hewlett-Packard Development Company, L.P.

The information contained herein is subject to change without notice.

Reproduction, adaptation or translation without prior written permission is prohibited, except as allowed under copyright laws.



Adobe and the Acrobat logo are either registered trademarks or trademarks of Adobe Systems Incorporated in the United States and/or other countries.

Windows®, Windows NT®, Windows Me®, Windows XP®, and Windows 2000® are U.S. registered trademarks of Microsoft Corporation.

Intel® and Pentium® are registered trademarks of Intel Corporation.

Energy Star® and Energy Star logo® are US registered marks of the United States Environmental Protection Agency.

Publication number: Q5800-90130

First edition: July 2004

## Notice

The only warranties for HP products and services are set forth in the express warranty statements accompanying such products and services. Nothing herein should be construed as constituting an additional warranty. HP shall not be liable for technical or editorial errors or omissions contained herein.

The Hewlett-Packard Company shall not be liable for incidental or consequential damages in connection with, or arising out of the furnishing, performance, or use of this document and the program material which it describes.

**Note:** Regulatory information can be found in the technical information chapter of this guide.



It is not lawful in many places to make copies of the following items. When in doubt, check with a legal representative first.

- Governmental paper or documents:
  - Passports
  - Immigration papers
  - Selective service papers
  - Identification badges, cards, or insignias
- Governmental stamps:
  - Postage stamps
  - Food stamps
- Checks or drafts drawn on Governmental agencies
- Paper currency, traveler's checks, or money orders
- Certificates of deposit
- Copyrighted works

## Safety information



**Warning** To prevent fire or shock hazard, do not expose this product to rain or any type of moisture.

Always follow basic safety precautions when using this product to reduce risk of injury from fire or electric shock.



**Warning** Potential shock hazard

- 1 Read and understand all instructions in the setup poster.
- 2 Use only a grounded electrical outlet when connecting the device to a power source. If you do not know whether the outlet is grounded, check with a qualified electrician.
- 3 Observe all warnings and instructions marked on the product.
- 4 Unplug this product from wall outlets before cleaning.
- 5 Do not install or use this product near water or when you are wet.
- 6 Install the product securely on a stable surface.
- 7 Install the product in a protected location where no one can step on or trip over the line cord, and where the line cord will not be damaged.
- 8 If the product does not operate normally, see the online Troubleshooting help.
- 9 No operator-serviceable parts inside. Refer servicing to qualified service personnel.
- 10 Use in a well-ventilated area.

# Contents

|          |   |           |
|----------|---|-----------|
| <b>1</b> | <b>HP all-in-one overview</b> .....                               | <b>5</b>  |
|          | The HP all-in-one at a glance.....                                | 5         |
|          | Control panel features.....                                       | 6         |
|          | Menu Overview.....  | 7         |
|          | Use the HP Image Zone to do more with your HP all-in-one.....     | 9         |
| <b>2</b> | <b>Find more information</b> .....                                | <b>15</b> |
| <b>3</b> | <b>Connection information</b> .....                               | <b>17</b> |
|          | Supported connection types.....                                   | 17        |
|          | Connect using a USB cable.....                                    | 18        |
|          | Use Windows printer sharing.....                                  | 18        |
|          | Use printer sharing (Macintosh OS X).....                         | 18        |
|          | Set up the HP JetDirect 175x.....                                 | 18        |
|          | Use Webscan.....  | 20        |
| <b>4</b> | <b>Work with photos</b> .....                                     | <b>21</b> |
|          | Transfer photos.....  | 21        |
|          | Edit photos.....  | 22        |
|          | Share photos.....   | 23        |
|          | Print photos.....   | 24        |
| <b>5</b> | <b>Load originals and load paper</b> .....                        | <b>25</b> |
|          | Load originals.....   | 25        |
|          | Choose papers for printing and copying.....                       | 26        |
|          | Load paper.....   | 27        |
|          | Avoid paper jams.....   | 32        |
| <b>6</b> | <b>Use a PictBridge camera</b> .....                              | <b>33</b> |
|          | To print photos from a PictBridge-compatible camera.....          | 33        |
| <b>7</b> | <b>Use the copy features</b> .....                                | <b>35</b> |
|          | Set the copy paper size.....                                      | 35        |
|          | Set the copy paper type.....                                      | 36        |
|          | Increase copy speed or quality.....                               | 37        |
|          | Change default copy settings.....                                 | 37        |
|          | Make multiple copies of the same original.....                    | 38        |
|          | Copy a two-page black-and-white document.....                     | 38        |
|          | Make a 10 by 15 cm (4 by 6 inch) borderless copy of a photo.....  | 39        |
|          | Copy a 10 by 15 cm (4 by 6 inch) photo onto a full-size page..... | 39        |
|          | Resize an original to fit onto letter or A4 paper.....            | 40        |
|          | Resize an original using custom settings.....                     | 41        |
|          | Copy a legal-size document onto letter paper.....                 | 41        |
|          | Copy a faded original.....  | 42        |
|          | Copy a document that has been faxed several times.....            | 42        |
|          | Enhance light areas of your copy.....                             | 43        |
|          | Prepare a color iron-on transfer.....                             | 43        |
|          | Stop copying.....   | 44        |
| <b>8</b> | <b>Use the scan features</b> .....                                | <b>45</b> |
|          | Scan to an application.....                                       | 45        |
|          | Stop scanning.....  | 46        |

|           |  |            |
|-----------|--|------------|
| <b>9</b>  | <b>Print from your computer</b> .....  | <b>47</b>  |
|           | Print from a software application.....   | 47         |
|           | Change the print settings.....   | 48         |
|           | Stop a print job.....  | 49         |
| <b>10</b> | <b>Fax setup</b> .....   | <b>51</b>  |
|           | Choose the right fax setup for your home or office.....                        | 52         |
|           | Select your fax setup case.....  | 53         |
|           | Case A: Separate fax line (no voice calls received).....                       | 55         |
|           | Case B: Set up your HP all-in-one with DSL.....                                | 56         |
|           | Case C: Set up your HP all-in-one with a PBX phone system or an ISDN line..... | 56         |
|           | Case D: Fax with a distinctive ring service on the same line.....              | 57         |
|           | Case E: Shared voice/fax line.....   | 58         |
|           | Case F: Shared voice/fax line with voice mail.....                             | 60         |
|           | Case G: Fax line shared with PC modem (no voice calls received).....           | 61         |
|           | Case H: Shared voice/fax line with PC modem.....                               | 62         |
|           | Case I: Shared voice/fax line with answering machine.....                      | 65         |
|           | Case J: Shared voice/fax line with PC modem and answering machine.....         | 67         |
|           | Case K: Shared voice/fax line with PC modem and voice mail.....                | 71         |
|           | Test your fax setup.....   | 74         |
| <b>11</b> | <b>Use the fax features</b> .....  | <b>77</b>  |
|           | Set up the HP all-in-one to receive faxes.....                                 | 77         |
|           | Send a fax.....  | 79         |
|           | Receive a fax.....   | 83         |
|           | Set the date and time.....   | 84         |
|           | Set the fax header.....  | 85         |
|           | Enter text and symbols.....  | 85         |
|           | Print reports.....   | 86         |
|           | Set up speed dialing.....  | 87         |
|           | Change the fax resolution and lighter/darker settings.....                     | 89         |
|           | Set fax options.....   | 90         |
|           | Reprint or delete the faxes in memory.....                                     | 95         |
|           | Fax over the Internet.....   | 95         |
|           | Stop faxing.....   | 96         |
| <b>12</b> | <b>Use HP Instant Share</b> .....  | <b>97</b>  |
|           | Overview.....  | 97         |
|           | Get started.....   | 97         |
|           | Send images using your HP all-in-one.....                                      | 98         |
|           | Send images using your computer.....   | 99         |
| <b>13</b> | <b>Order supplies</b> .....  | <b>103</b> |
|           | Order paper, transparency film, or other media.....                            | 103        |
|           | Order print cartridges.....  | 103        |
|           | Order other supplies.....  | 103        |
| <b>14</b> | <b>Maintain your HP all-in-one</b> .....                                       | <b>105</b> |
|           | Clean the HP all-in-one.....   | 105        |
|           | Print a self-test report.....  | 108        |
|           | Work with print cartridges.....  | 109        |
|           | Change the device settings.....  | 118        |
| <b>15</b> | <b>Troubleshooting information</b> .....                                       | <b>119</b> |
|           | Before you call HP Support.....  | 119        |
|           | View the Readme file.....  | 120        |

|  |            |
|--|------------|
| Setup troubleshooting.....                               | 120        |
| Operational troubleshooting.....                         | 141        |
| Device update.....                                       | 145        |
| <b>16 Get HP support.....</b>                            | <b>147</b> |
| Get support and other information from the Internet..... | 147        |
| HP customer support.....                                 | 147        |
| Access your serial number and service ID.....            | 147        |
| Call in North America during warranty.....               | 148        |
| Call elsewhere in the world.....                         | 148        |
| Call in Australia post-warranty.....                     | 150        |
| Call HP Korea customer support.....                      | 151        |
| Call HP Japan customer support.....                      | 151        |
| Prepare your HP all-in-one for shipment.....             | 152        |
| <b>17 Warranty information.....</b>                      | <b>155</b> |
| Duration of limited warranty.....                        | 155        |
| Warranty service.....                                    | 155        |
| Warranty upgrades.....                                   | 155        |
| Returning your HP all-in-one for service.....            | 155        |
| Hewlett-Packard limited global warranty statement.....   | 156        |
| <b>18 Technical information.....</b>                     | <b>159</b> |
| System requirements.....                                 | 159        |
| Paper specifications.....                                | 159        |
| Print specifications.....                                | 160        |
| Copy specifications.....                                 | 161        |
| Fax specifications.....                                  | 161        |
| Scan specifications.....                                 | 162        |
| Physical specifications.....                             | 162        |
| Power specifications.....                                | 162        |
| Environmental specifications.....                        | 162        |
| Additional specifications.....                           | 162        |
| Environmental product stewardship program.....           | 162        |
| Regulatory notices.....                                  | 163        |
| Declaration of conformity.....                           | 167        |
| <b>Index.....</b>  | <b>169</b> |



# 1 HP all-in-one overview

Many HP all-in-one functions can be accessed directly, without turning on your computer. Tasks such as making a copy and sending a fax can be accomplished quickly and easily from your HP all-in-one.

This chapter describes the HP all-in-one hardware features, control panel functions, and how to access the **HP Image Zone** software. Your HP all-in-one might not have all of the features described in this guide.

**Tip** You can do more with your HP all-in-one by using the **HP Image Zone** software installed on your computer during the initial setup. The software provides enhanced copy and scan functionality, as well as troubleshooting tips and product-specific help. For more information, see the onscreen **HP Image Zone Help** and [Use the HP Image Zone to do more with your HP all-in-one](#).

## The HP all-in-one at a glance

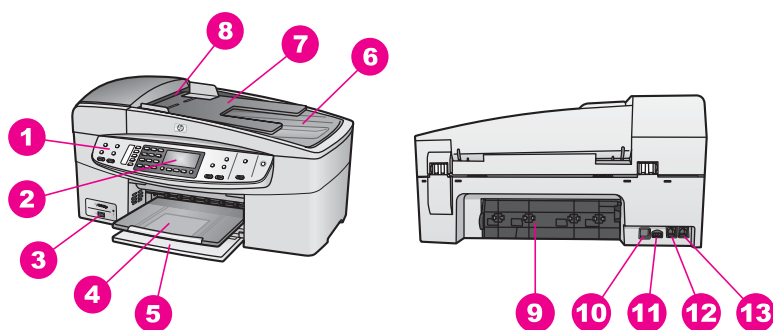

| Label | Description               |
|-------|---------------------------|
| 1     | Control panel             |
| 2     | Control panel display     |
| 3     | Camera port               |
| 4     | Output tray               |
| 5     | Input tray                |
| 6     | Lid                       |
| 7     | Document feeder tray      |
| 8     | Automatic document feeder |
| 9     | Rear clean-out door       |
| 10    | Rear USB port             |



(continued)

| Label | Description        |
|-------|--------------------|
| 11    | Power connection   |
| 12    | Fax port (1-LINE)  |
| 13    | Phone port (2-EXT) |

## Control panel features

The following diagram and related table provide a quick reference to your HP all-in-one control panel features.

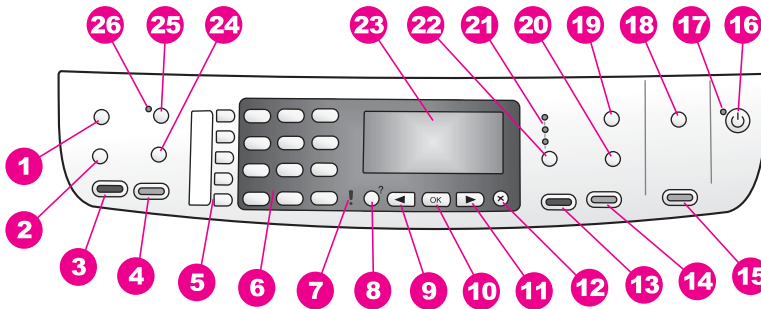

| Label | Name and Description  |
|-------|---|
| 1     | <b>Menu:</b> Select fax options such as <b>Resolution</b> and <b>Lighter/Darker</b> using the <b>Menu</b> button in the Fax area. |
| 2     | <b>Speed Dial:</b> Select a speed dial number.  |
| 3     | <b>Start Fax Black:</b> Start a black and white fax.  |
| 4     | <b>Start Fax Color:</b> Start a color fax.  |
| 5     | <b>One-touch speed dial buttons:</b> Access the first five speed dial numbers.  |
| 6     | <b>Keypad:</b> Enter fax numbers, values, or text.  |
| 7     | <b>Attention light:</b> When blinking, the attention light indicates an error has occurred that requires your attention.          |
| 8     | <b>Setup/?:</b> Access the menu system for reports, fax settings, and maintenance. Also access product-launched Help.             |
| 9     | <b>Left arrow:</b> Decrease values on the control panel display.  |
| 10    | <b>OK:</b> Select a menu or a setting in the control panel display.   |
| 11    | <b>Right arrow:</b> Increase values on the control panel display.   |
| 12    | <b>Cancel:</b> Stop a job, exit a menu, or exit settings.   |

(continued)

|    |   |
|----|---|
| 13 | <b>Start Copy Black:</b> Start a black and white copy job.  |
| 14 | <b>Start Copy Color:</b> Start a color copy job.  |
| 15 | <b>Start Scan:</b> Start a scan job and send it to the destination you selected using the <b>Scan To</b> button.  |
| 16 | <b>On:</b> Turn the HP all-in-one on or off. When the HP all-in-one is off, a minimal amount of power is still supplied to the device. To completely disconnect the power supply to the HP all-in-one, turn the device off, and then unplug the power cord. |
| 17 | <b>On light:</b> When lit, the On light indicates that the HP all-in-one is on. The light blinks while performing a job.  |
| 18 | <b>Scan To:</b> Select a scan destination.  |
| 19 | <b>Menu:</b> Select copy options, including <b>Tray Select</b> , <b>Paper Type</b> , <b>Paper Size</b> , and several other options, using the <b>Menu</b> button in the Copy area.  |
| 20 | <b>Reduce/Enlarge:</b> Change the size of the photo or copy for printing.   |
| 21 | <b>Copy quality lights:</b> Indicates selected copy quality.  |
| 22 | <b>Quality:</b> Control the speed and quality of copies.  |
| 23 | <b>Control panel display:</b> View menus and messages.  |
| 24 | <b>Redial/Pause:</b> Redial the most recently dialed number, or insert a 3-second pause in a fax number.  |
| 25 | <b>Auto Answer:</b> Set the fax function to answer the phone automatically when a fax is sent to the device.  |
| 26 | <b>Auto Answer light:</b> When lit, the HP all-in-one is set to receive faxes automatically.  |

## Menu Overview

The following tables provide a quick reference to top-level menus that appear on the HP all-in-one color graphics display.

### Copy Menu

| Copy Menu           |
|---------------------|
| 1. Number of Copies |
| 2. Copy Paper Size  |
| 3. Copy Paper Type  |
| 4. Lighter/Darker   |
| 5. Enhancements     |
| 6. Color Intensity  |
| 7. Set New Defaults |

## Scan To menu

The **Scan To** menu lists scan destinations, including applications installed on your computer.

**Note** Depending on the applications installed on your computer, your **Scan To** menu might list scan destinations different than the ones shown here.

### Scan To (USB - Windows)

1. HP Image Zone
2. Microsoft PowerPoint
3. Adobe Photoshop
4. HP Instant Share

### Scan To (USB - Macintosh)

1. JPEG to HP Gallery
2. Microsoft Word
3. Microsoft PowerPoint
4. HP Instant Share

## Fax Menu

### Fax Menu

1. Fax Number
2. Fax Resolution
3. Lighter/Darker
4. How to Fax
5. Set New Defaults

## Setup Menu

The **Help Menu** selection on the **Setup Menu** provides quick access to key help topics. Most of the information is presented on a connected Windows PC or Macintosh computer screen.

### Setup Menu

1. Help
2. Print Report
3. Speed Dial Setup
4. Basic Fax Setup
5. Advanced Fax Setup
6. Tools
7. Preferences

## Use the HP Image Zone to do more with your HP all-in-one

The **HP Image Zone** software is installed on your computer when you set up your HP all-in-one. For further information, see the Setup Guide that came with your device.

Access to the **HP Image Zone** software differs by operating system (OS). For example, if you have a PC and are running Windows, the **HP Image Zone** software entry point is the **HP Director**. If you have a Macintosh and are running OS X V10.1.5 or later, the **HP Image Zone** software entry point is the **HP Image Zone** window. Regardless, the entry point serves as the launching pad for the **HP Image Zone** software and services.

You can quickly and easily expand the functionality of your HP all-in-one by using the **HP Image Zone** software. Look for boxes like this throughout the guide that provide topic-specific tips and helpful information for your projects.

### Access the HP Image Zone software (Windows)

Open the **HP Director** from the desktop icon, system tray icon, or the **Start** menu. The **HP Image Zone** software features appear in the **HP Director**.

**Note** **HP Image Zone** software features are not available if you are using an HP JetDirect 175x. For more information, see [Connection information](#).



#### To open the HP Director

- Do one of the following:
  - On the Windows desktop, double-click the **HP Director** icon.
  - In the system tray at the far right of the Windows taskbar, double-click the **Hewlett-Packard Digital Imaging Monitor** icon.
  - On the taskbar, click **Start**, point to **Programs** or **All Programs**, select **HP**, and then click **HP Director**.
- In the **Select Device** box, click to see a list of installed devices.
- Select the HP all-in-one.

**Note** The icons in the **HP Director** graphic below might appear differently on your computer. The **HP Director** is customized to display icons associated with the device that is selected. If the selected device is not equipped with a particular feature or function, then the icon for that feature or function does not display in the **HP Director**.

**Tip** If the **HP Director** on your computer does not contain any icons, an error might have occurred during the software installation. To correct this, use the Control Panel in Windows to completely uninstall the **HP Image Zone** software; then reinstall the software. For more information, see the Setup Guide that came with your HP all-in-one.

| Button  | Name and Purpose  |
|---|---|
|  | <b>Scan Picture:</b> Scans a photo, picture, or drawing and displays it in the <b>HP Image Zone</b> . |

| Button  | Name and Purpose   |
|---|--|
|  | <b>Scan Document:</b> Scans a document that contains text or both text and graphics, and displays it in your selected program.   |
|  | <b>Make Copies:</b> Displays the Copy dialog box for the selected device, from which you can make a printed copy of your image or document. You can select the copy quality, number of copies, color, and size.  |
|  | <b>HP Image Zone:</b> Displays the <b>HP Image Zone</b> , where you can: <ul style="list-style-type: none"> <li>• View and edit images</li> <li>• Print photos in multiple sizes</li> <li>• Make and print a photo album, postcard, or flyer</li> <li>• Make a multimedia CD (only available if the HP Memories Disc software is installed)</li> <li>• Share images through e-mail or a website</li> </ul> |

**Note** For information on additional features and menu items such as Software Update, Creative Ideas, and HP Shopping, see the onscreen **HP Image Zone Help**.

Menu and list items are also available to help you select the device you want to use, check its status, adjust a variety of software settings, and access the onscreen help. The following table explains these items.

| Feature       | Purpose   |
|---------------|---|
| Help          | Use this feature to access the <b>HP Image Zone Help</b> , which provides software help and troubleshooting information for your HP all-in-one. |
| Select Device | Use this feature to select the device you want to use from the list of installed devices.   |
| Settings      | Use this feature to view or change various settings for your HP all-in-one, such as print, scan, or copy.                                       |
| Status        | Use this feature to display the current status of your HP all-in-one.   |

### Open the HP Image Zone software (Macintosh OS X v10.1.5 or later)

**Note** Macintosh OS X v10.2.1 and v10.2.2 are not supported.

When you install the **HP Image Zone** software, the **HP Image Zone** icon is placed in the Dock.

**Note** If you install more than one HP all-in-one, an **HP Image Zone** icon for each device is displayed in the Dock. For example, if you have an HP scanner and an HP all-in-one installed, two **HP Image Zone** icons are present in the Dock, one for each device. However, if you installed two of the same kind of device (for example, two HP all-in-ones) only one **HP Image Zone** icon is displayed in the Dock to represent all devices of that kind.

You can access the **HP Image Zone** software in one of two ways:

- Through the **HP Image Zone** window
- Through the **HP Image Zone** Dock menu

### Open the HP Image Zone window

Select the **HP Image Zone** icon to open the **HP Image Zone** window. The **HP Image Zone** window has two main elements:

- The display area for the **Products/Services** tabs
  - The **Products** tab gives you access to many of the features of your HP imaging products, such as an installed products pop-up menu and a list of tasks available for the current product. The list may include tasks such as copy, scan, or fax. Clicking on a task opens an application to assist you with that task.
  - The **Services** tab gives you access to digital imaging applications that can help you view, edit, manage, and share you images.
- The **Search HP Image Zone Help** text entry field  
The **Search HP Image Zone Help** text entry field lets you search **HP Image Zone Help** for keywords or phrases.



### To open the HP Image Zone window

→ Click the **HP Image Zone** icon in the Dock.



The **HP Image Zone** window appears.

The **HP Image Zone** window displays only the **HP Image Zone** features that are appropriate for the selected device.

**Note** The icons in the table below might appear differently on your computer. The **HP Image Zone** window is customized to display feature icons associated with the device that is selected. If the selected device is not equipped with a particular feature or function, then that feature or function does not display in the **HP Image Zone** window.

| Products  |   |
|---|---|
| Icon  | Feature and Purpose   |
|  | <b>Scan Picture:</b> Use this feature to scan an image and display it in the <b>HP Gallery</b> .  |
|  | <b>Scan to OCR:</b> Use this feature to scan text and display it in the selected destination text editing software program.<br><br><b>Note</b> Availability of this feature varies by country/region. |
|  | <b>Make Copies:</b> Use this feature to make a copy in black and white or color.  |

## Services

| Icon  | Feature and Purpose  |
|---|--|
|  | <b>HP Gallery:</b> Use this feature to display the <b>HP Gallery</b> to view and edit images.  |
|  | <b>HP Image Print:</b> Use this feature to print images from an album using one of several templates available.  |
|  | <b>HP Instant Share:</b> Use this feature to open the <b>HP Instant Share</b> client application software. From the client application software you can share photos with family and friends using <b>HP Instant Share E-mail</b> or upload photos to an online photo album or online photo finishing service. |

In addition to the feature icons, several menu and list items allow you to select the device you want to use, adjust a variety of software settings, and access the onscreen help. The following table explains these items.

| Feature                          | Purpose   |
|----------------------------------|---|
| Select Device                    | Use this feature to select the device you want to use from a list of installed devices.   |
| Settings                         | Use this feature to view or change various settings for your HP all-in-one, such as print, scan, or copy.                                       |
| Search <b>HP Image Zone Help</b> | Use this feature to search the <b>HP Image Zone Help</b> , which provides software help and troubleshooting information for your HP all-in-one. |

### Display the HP Image Zone Dock menu

The **HP Image Zone** Dock menu provides a shortcut to **HP Image Zone** services. The Dock menu automatically contains all of the applications available in the **HP Image Zone** window **Services** tab list. You can also set **HP Image Zone** preferences to add other items to the menu, such as tasks from the **Products** tab list or **HP Image Zone Help**.

### To display the HP Image Zone Dock menu

- Do one of the following:
- Set either **HP Gallery** or **iPhoto** as your preferred photo manager.
  - Set additional options associated with your preferred photo manager.
  - Customize the list of items displayed in the **HP Image Zone** Dock menu.

### Access the HP Image Zone software (Macintosh OS earlier than X v10.1.5)

**Note** Macintosh OS 9 v9.1.5 and later and v9.2.6 and later **are** supported. Macintosh OS X v10.0 and v10.0.4 are **not** supported.

The **HP Director** is the entry point to the **HP Image Zone** software. Depending on the capabilities of your HP all-in-one, the **HP Director** lets you initiate device functions such as scanning, copying, or faxing. You can also use the **HP Director** to open the **HP Gallery** to view, modify, and manage images on your computer.

Use one of the following methods to open the **HP Director**. The methods are Macintosh OS specific.

- Macintosh OS X: The **HP Director** opens automatically during **HP Image Zone** software installation, and an **HP Director** icon is created in the Dock for your device. To display the **HP Director** menu:

In the Dock, click the **HP Director** icon for your device.

The **HP Director** menu appears.



**Note** If you install several HP devices of different kinds (for example, an HP all-in-one, a camera, and an HP scanner), an **HP Director** icon for each kind of device is displayed in the Dock. However, if you install two of the same kind of device (for example, you may have a laptop that you connect to two different HP all-in-one devices -- one at work and one at home) only one **HP Director** icon is displayed in the Dock.

- Macintosh OS 9: The **HP Director** is a standalone application that must be opened before its features can be accessed. Use one of the following methods to open the **HP Director**:
  - Double-click the **HP Director** alias on the desktop.
  - Double-click the **HP Director** alias in the **Applications:Hewlett-Packard:HP Photo and Imaging Software** folder.

The **HP Director** displays only the task buttons that pertain to the selected device.

**Note** The icons in the table below might appear differently on your computer. The **HP Director** menu is customized to display feature icons associated with the device that is selected. If the selected device is not equipped with a particular feature or function, then the icon for that feature or function does not display.

## Device Tasks

| Icon  | Purpose   |
|---|---|
|  | <b>Scan Picture:</b> Use this feature to scan an image and display it in the <b>HP Gallery</b> .  |
|  | <b>Scan Document:</b> Use this feature to scan text and display it in the selected destination text editing software program.<br><b>Note</b> Availability of this feature varies by country/region. |
|  | <b>Make Copies:</b> Use this feature to make a copy in black and white or color.  |



---

## Manage and Share

---

| Icon  | Purpose   |
|---|---|
|  | <b>HP Gallery:</b> Use this feature to display the <b>HP Gallery</b> to view and edit images. |

In addition to the **HP Gallery** feature, several menu items without icons allow you to select other applications on your computer, change feature settings on your HP all-in-one, and access the onscreen help. The following table explains these items.

---





## Manage and Share

---

| Feature           | Purpose   |
|-------------------|---|
| More Applications | Use this feature to select other applications on your computer.   |
| HP on the Web     | Use this feature to select an HP website.   |
| HP Help           | Use this feature to select a source for help with your HP all-in-one.                                     |
| Settings          | Use this feature to view or change various settings for your HP all-in-one, such as print, scan, or copy. |

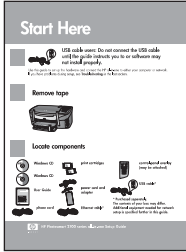
# 2 Find more information

A variety of resources, both printed and onscreen, provide information about setting up and using your HP all-in-one.

|   |  |
|---|--|
|    | <h3>Setup Guide</h3> <p>The Setup Guide provides instructions for setting up your HP all-in-one and installing software. Make sure you follow the steps in order.</p> <p>If you have problems during setup, see Troubleshooting in the last section of the Setup Guide, or the Troubleshooting chapter in this guide.</p>  |
|    | <h3>User Guide</h3> <p>This User Guide contains information on how to use your HP all-in-one, including troubleshooting tips and step-by-step instructions.</p>  |
|    | <h3>HP Image Zone Tour</h3> <p>The HP Image Zone Tour is a fun, interactive way to get a brief overview of the software included with your HP all-in-one. You'll learn how <b>HP Image Zone</b> can help you edit, organize, and print your photos.</p>  |
|  | <h3>HP Director</h3> <p>The HP Director provides easy access to the software applications, default settings, status, and onscreen Help for your HP device. To start the <b>HP Director</b>, double-click the <b>HP Director</b> icon from your desktop.</p>  |
|  | <h3>HP Image Zone Help</h3> <p>The HP Image Zone Help provides detailed information on using the software for your HP all-in-one.</p> <ul style="list-style-type: none"><li>• The <b>Get step-by-step instructions</b> topic provides information on using the <b>HP Image Zone</b> software with HP devices.</li><li>• The <b>Explore what you can do</b> topic provides more information about the practical and creative things you can do with the <b>HP Image Zone</b> software and your HP devices.</li><li>• If you need further assistance or want to check for HP software updates, see the <b>Troubleshooting and support</b> topic.</li></ul> |

Find more information



### Onscreen help from your device

Onscreen help is available from your device and contains additional information on select topics. Access the onscreen help from the control panel.

From the control panel, press the **Setup** button next to the **?** and then press **1**. Use the **▶** to scroll through the list of available topics. Highlight the appropriate topic and press **OK**.

### Readme

The Readme file contains the most recent information which might not be found in other publications.

Install the software to access the Readme file.

[www.hp.com/support](http://www.hp.com/support)

If you have internet access, you can get help and support from the HP website. This website offers technical support, drivers, supplies, and ordering information.

# 3 Connection information

Your HP all-in-one comes equipped with a USB port so you can connect directly to a computer using a USB cable. It also has networking capability which can be accessed by using an external print server (HP JetDirect 175x). The HP JetDirect can be purchased as an accessory for your HP all-in-one and lets you easily share your device through an existing Ethernet network.

## Supported connection types

| Description  | Recommended number of connected computers for best performance   | Supported software features  | Setup instructions  |
|--|--|--|---|
| USB connection   | One computer connected by means of a USB cable to the device.<br><br>The USB port is located on the rear of the HP all-in-one. | All features are supported from your computer.   | Follow the Setup Guide for detailed instructions.                         |
| Windows printer sharing  | Up to five.<br>The “host” computer must be on at all times in order to print from the other computers.                         | All features resident on the host computer are supported. Only print is supported from the other computers.  | See the Windows Printer Sharing setup instructions below.                 |
| Printer sharing (Macintosh)  | Up to five.<br>The “host” computer must be on at all times in order to print from the other computers.                         | All features resident on the host computer are supported. Only print is supported from the other computers.  | See the Printer Sharing setup instructions below.                         |
| Networked by means of the HP JetDirect 175x (J6035C)<br><br>Availability of the HP JetDirect product varies by country/region. | Up to five network-connected computers.  | Only print and Webscan are supported from your computer. (For more information on Webscan, see <a href="#">Use Webscan.</a> )<br><br>Copy, fax, and printing are supported from the control panel of your HP all-in-one. | For setup instructions, see <a href="#">Set up the HP JetDirect 175x.</a> |

## Connect using a USB cable

Detailed instructions for connecting a computer to your HP all-in-one using a USB cable are included in the Setup Guide that came with your device.

## Use Windows printer sharing

If your computer is on a network, and another computer on the network has an HP all-in-one connected to it by means of a USB cable, you can use that device as your printer using Windows printer sharing. The computer directly connected to the HP all-in-one acts as the host for the printer and has full feature functionality. Your computer, which is referred to as a client, has access only to the print features. All other functions must be performed on the host computer.

### To enable Windows printer sharing

→ Refer to the user guide that came with your computer or Windows onscreen Help.

## Use printer sharing (Macintosh OS X)

If your computer is on a network, and another computer on the network has an HP all-in-one connected to it by means of a USB cable, you can use that device as your printer using printer sharing. The computer directly connected to the HP all-in-one acts as the host for the printer and has full feature functionality. Your computer, which is referred to as a client, has access only to the print features. All other functions must be performed on the host computer.

### To enable printer sharing

- 1 On the host computer, select **System Preferences** in the Dock. The **System Preferences** window appears.
- 2 Select **Sharing**.
- 3 From the **Services** tab, click **Printer Sharing**.

## Set up the HP JetDirect 175x

Your HP all-in-one can be shared by up to five computers on a local area network (LAN) by using the HP JetDirect 175x as a print server for all computers on the network. Simply connect your HP JetDirect to your HP all-in-one and router or hub, and then run the HP JetDirect installation CD. The required printer drivers (INF file) are located on the installation CD for your HP all-in-one.

**Note** Using the HP JetDirect 175x, you can print and send a scan using Webscan from your computer; you can make copies, send a fax, and print from the control panel of your HP all-in-one.

### To network connect your HP all-in-one using the HP JetDirect 175x (Windows)

- 1 Before you follow the steps below:
  - Uninstall the **HP Image Zone** software from your computer if your HP all-in-one has been connected to a computer with a USB cable and you now want to

connect it to a network using an HP JetDirect. For more information, see [Uninstall and reinstall the software](#).

- Use the Setup Guide for your HP all-in-one and follow the hardware setup instructions if you are performing an initial installation of both your HP all-in-one and HP JetDirect 175x.
- 2 Follow the HP JetDirect 175x setup instructions to connect the print server to a LAN.
  - 3 Connect the HP JetDirect to the USB port on the rear of your HP all-in-one.
  - 4 Insert the installation CD that was supplied with the HP JetDirect into your computer's CD-ROM drive.  
You will use this CD to locate the HP JetDirect on the network.
  - 5 Select **Install** to run the HP JetDirect installer.
  - 6 When prompted, insert the HP all-in-one installation CD.

**Note** If you are performing an initial installation of your HP all-in-one and HP JetDirect 175x, do not run the HP all-in-one setup wizard. Just install the drivers following the instructions below.

If you decide at some later date to connect your HP all-in-one using a USB cable, then insert the HP all-in-one installation CD and run the setup wizard.

- 7 Follow the steps appropriate for your operating system:

**If you are using Windows XP or 2000:**

- a Browse to the root directory of the CD and select the correct driver .inf for your HP all-in-one.  
The printer driver file, located in the root directory, is hpoprn08.inf.

**If you are using Windows 98 or ME:**

- a Browse the CD for the "Drivers" folder and find the correct language subfolder. For example, for English speaking customers, navigate to the \enu\drivers\win9x\_me directory, where enu is the English language directory and win9x\_me is for Windows ME. The printer driver file is hpoupdrx.inf.
- b Repeat for each of the drivers required.

- 8 Complete the installation.

**Note** If, at some later time, you want to connect to your PC using a USB cable, disconnect the HP JetDirect from your HP all-in-one, uninstall the HP printer driver from your computer, and follow the instructions provided in the Setup Guide that came with your HP all-in-one.

**To network connect your HP all-in-one using the HP JetDirect 175x (Macintosh)**

- 1 Follow the HP JetDirect 175x setup instructions to connect the print server to a LAN.
- 2 Connect the HP JetDirect to the USB port on the rear of your HP all-in-one.
- 3 Do one of the following:
  - If you are performing an initial installation of your HP all-in-one, make sure you insert the HP all-in-one installation CD into the CD-ROM drive on your computer and run the HP all-in-one setup wizard.  
The network support software for your computer is installed at this time.

When the installation is finished, the **HP All-in-One Setup Assistant** appears on your computer.

- From the Disk Drive, open the **HP All-in-One Setup Assistant** from the following location: Applications:Hewlett-Packard:HP Photo & Imaging Software:HP AiO Software

The **HP All-in-One Setup Assistant** appears on your computer.

- 4 Follow the onscreen prompts and provide the information requested.

**Note** Make sure you click **TCP/IP Network** on the connection screen.

## Use Webscan

Webscan lets you perform a basic scan through the HP JetDirect 175x using just a Web browser. It also lets you perform the scan from your HP all-in-one without the device software installed on your computer. Just enter the IP address of the HP JetDirect in a Web browser and access the HP JetDirect embedded Web server and Webscan.

The user interface for Webscan is unique to using the HP JetDirect and does not support scan-to destinations like the **HP Image Zone** scanning software. The e-mail functionality of Webscan is limited, so it is recommended you use the **HP Image Zone** scanning software if you are not connected using the HP JetDirect.

### To use Webscan

- 1 Briefly press and release the test button on the rear of the HP JetDirect 175x. The HP JetDirect network configuration page prints on the HP all-in-one.
- 2 Enter the IP address of the HP JetDirect (obtained from the network configuration page) in a Web browser on your computer. The HP JetDirect Web server opens in the browser window.
- 3 Select Scan.
- 4 Follow the onscreen instructions.

# 4 Work with photos

Your HP all-in-one allows you to transfer, edit, share, and print photos in several different ways. This chapter contains a brief overview of the wide range of options for performing each of these tasks, depending on your preferences and computer setup. More detailed information for each task is available in other chapters within this guide, or in the onscreen **HP Image Zone Help**.

## Transfer photos

You have several different options for transferring photos. You can transfer photos to your HP all-in-one or computer. For more information, see the section below specific to your operating system.

### Transfer photos using a Windows PC

The graphic below shows several methods for transferring photos to your Windows PC. For more information, see the list below the graphic.

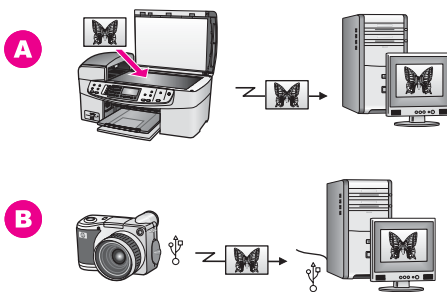

|          |  |
|----------|--|
| <b>A</b> | Transfer a photo by scanning a photo on your HP all-in-one directly to your Windows PC using HP Instant Share. |
| <b>B</b> | Transfer a photo from your HP digital camera to your Windows PC.   |

**Note** You can only print photos using the PictBridge camera port on the front of your HP all-in-one. You cannot transfer photos from the camera to your computer using the HP all-in-one PictBridge camera port.

### Transfer photos using a Macintosh

The graphic below shows several methods for transferring photos to your Macintosh. For more information, see the list below the graphic.



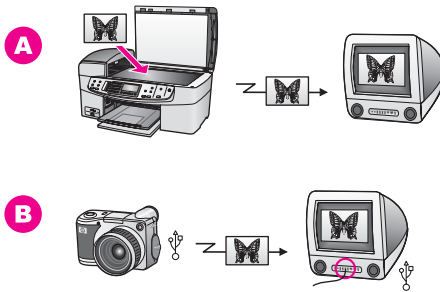

|          |   |
|----------|---|
| <b>A</b> | Transfer a photo by scanning a photo on your HP all-in-one directly to your Macintosh using HP Instant Share. |
| <b>B</b> | Transfer a photo from your HP digital camera to your Macintosh.   |

**Note** You can only print photos using the PictBridge camera port on the front of your HP all-in-one. You cannot transfer photos from the camera to your computer using the HP all-in-one PictBridge camera port.

## Edit photos

You have several different options for editing photos. For more information, see the section below specific to your operating system.

### Edit photos using a Windows PC

The graphic below shows one method for editing photos using a Windows PC. For more information, see the description below the graphic.

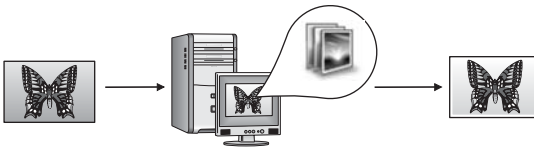

Edit a photo on your Windows PC using the **HP Image Zone** software.

### Edit photos using a Macintosh

The graphic below shows several methods for editing photos using a Macintosh. For more information, see the list below the graphic.

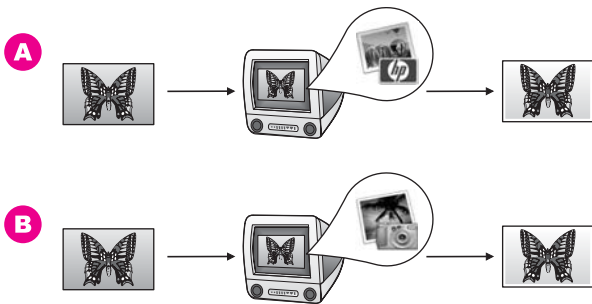

|          |   |
|----------|---|
| <b>A</b> | Edit a photo on your Macintosh using the <b>HP Image Zone</b> software. |
| <b>B</b> | Edit a photo on your Macintosh using the iPhoto software.               |

## Share photos

You have several different options for sharing photos with friends and family. For more information, see the section below specific to your operating system.

### Share photos using a Windows PC

The graphic below shows one method for sharing photos using a Windows PC. For more information, see the information below the graphic.

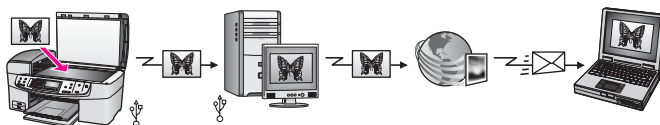

Share photos from your USB-connected HP all-in-one using the HP Instant Share service. Scan the photos to the HP Instant Share destination. This sends the scanned image to the HP Instant Share tab within the **HP Image Zone** software. From there, you can select a service (such as e-mail) to send the photos through the HP Instant Share service to your friends or family.

### Share photos using a Macintosh

The graphic below shows one method for sharing photos using a Macintosh. For more information, see the information below the graphic.

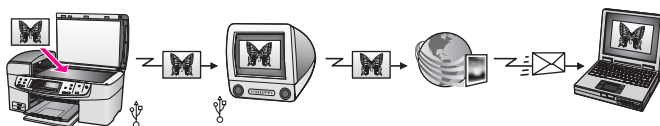

Share photos from your USB-connected HP all-in-one using the HP Instant Share service. Scan the photos to the HP Instant Share destination. This sends the scanned image to the HP Instant Share client application software. From there, you can select a

service (such as e-mail) to send the photos through the HP Instant Share service to your friends or family.

## Print photos

You have several different options for printing photos. For more information, see the section below specific to your operating system.

### Print photos using a Windows PC

The graphic below shows several methods for printing photos using a Windows PC. For more information, see the list below the graphic.

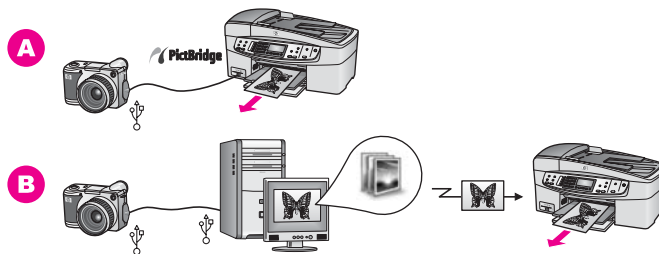

|          |  |
|----------|--|
| <b>A</b> | Print photos from your PictBridge-compatible digital camera.   |
| <b>B</b> | Print photos from your camera using a software application (such as <b>HP Image Zone</b> ) on your Windows PC. |

### Print photos using a Macintosh

The graphic below shows several methods for printing photos using a Macintosh. For more information, see the list below the graphic.

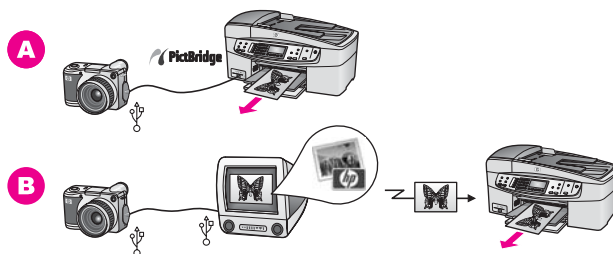

|          |   |
|----------|---|
| <b>A</b> | Print photos from your PictBridge-compatible digital camera.  |
| <b>B</b> | Print photos from your camera using a software application (such as <b>HP Image Zone</b> ) on your Macintosh. |

# 5 Load originals and load paper

This chapter provides instructions for loading originals in the automatic document feeder or on the glass to copy, scan, or fax; choosing the best paper type for your job; loading paper in the input tray; and avoiding paper jams.

## Load originals

You can load an original for a copy, fax, or scan job in the automatic document feeder or on the glass. Originals that are loaded in the automatic document feeder will automatically be fed into the HP all-in-one.

### Load an original in the automatic document feeder

You can copy, scan, or fax a multiple-page letter-, A4-, or legal-size document (up to 20 pages) by placing it in the document feeder tray.



**Warning** Do not load photos in the automatic document feeder; this might cause damage to your photos.

**Note** Some features, such as the **Fit to Page** and **Fill Entire Page** copy features, do not work when you load your originals in the automatic document feeder. For more information, see [Load an original on the glass](#).

### To load an original in the automatic document feeder

- 1 Load your originals face up in the document feeder tray with the top of the page on the left. Keep sliding the paper leftward into the automatic document feeder until you hear a beep. This indicates that the HP all-in-one detected the pages you loaded.

The automatic document feeder holds a maximum of 20 sheets of plain paper.

**Tip** For more help on loading originals in the automatic document feeder, refer to the diagram engraved in the document feeder tray.

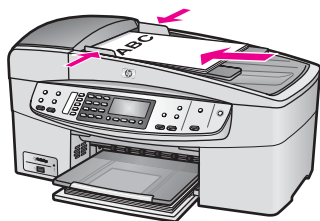

- 2 Slide the paper guides inward until they stop at the left and right edges of the paper.

### Load an original on the glass

You can copy, scan, or fax up to letter- or A4-size single-page originals by loading them on the glass, as described here. If your original contains multiple full-size pages, load it

in the automatic document feeder. For more information, see [Load an original in the automatic document feeder](#).

**Note** Many of the special features will not work correctly if the glass and lid backing are not clean. For more information, see [Clean the HP all-in-one](#).

### To load an original on the glass

- 1 Remove all originals from the document feeder tray, and then lift the lid on the HP all-in-one.
- 2 Place your original face down on the right front corner of the glass.

**Tip** For more help on loading an original, refer to the guides along the front and right edges of the glass.

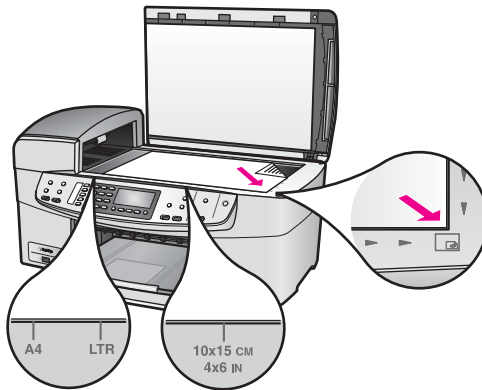

- 3 Close the lid.

## Choose papers for printing and copying

You can use many types and sizes of paper in your HP all-in-one. Review the following recommendations to get the best printing and copying quality. Whenever you change paper types or sizes, remember to change those settings.

### Recommended papers

If you want the best print quality, HP recommends using HP papers that are specifically designed for the type of project you are printing. If you are printing photos, for example, load glossy or matte photo paper in the input tray. If you are printing a brochure or presentation, use a type of paper specifically designed for that purpose.

For more information about HP papers, see the onscreen **HP Image Zone Help**, or go to [www.hp.com/support](http://www.hp.com/support).

### Papers to avoid

Using paper that is too thin, paper that has a slick texture, or paper that stretches easily can cause paper jams. Using paper that has a heavy texture or does not accept ink can cause printed images to smear, bleed, or not fill in completely.

**We do not recommend printing to the following papers:**

- Paper with cutouts or perforations (unless specifically designed for use with HP inkjet devices).
- Highly textured stock, such as linen. It may not print evenly, and the ink can bleed into these papers.
- Extremely smooth, shiny, or coated papers not specifically designed for your HP all-in-one. They can jam the HP all-in-one or repel the ink.
- Multi-part forms (such as duplicate and triplicate forms). They can wrinkle or get stuck. The ink is also more likely to smear.
- Envelopes with clasps or windows.
- Banner paper.

**We do not recommend copying to the following papers:**

- Any size paper other than letter, A4, 10 by 15 cm (4 by 6 inch), 5 by 7 inch, Hagaki, L, or legal. Depending on your country/region, some of these papers might not be available to you.
- Paper with cutouts or perforations (unless specifically designed for use with HP inkjet devices).
- Envelopes.
- Banner paper.
- Transparency film other than HP Premium Inkjet Transparency Film or HP Premium Plus Inkjet Transparency Film.
- Multiple-part forms or label stock.

## Load paper

This section describes the procedure for loading different types and sizes of paper into your HP all-in-one for your copies, printouts, or faxes.

**Tip** To help prevent rips, wrinkles, and curled or bent edges, store all paper flat in a resealable bag. If the paper is not stored properly, extreme changes in temperature and humidity might result in curled paper that does not work well in the HP all-in-one.

### Load full-size paper

You can load many types of letter, A4, or legal paper into the input tray of your HP all-in-one.

#### To load full-size paper in the input tray

- 1 Remove the output tray, and slide the paper-width guide to its outermost position.

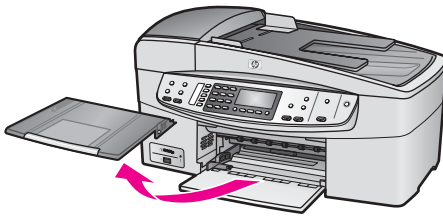

- 2 Tap a stack of paper on a flat surface to align the edges, and then check the paper for the following:
  - Make sure it is free of rips, dust, wrinkles, and curled or bent edges.
  - Make sure all the paper in the stack is the same size and type.
- 3 Insert the stack of paper into the input tray with the short edge forward and the print side down. Slide the stack of paper forward until it stops.

**Note** Make sure that the HP all-in-one is idle and silent when you load paper into the input tray. If the HP all-in-one is servicing the print cartridges or otherwise engaged in a task, the paper stop inside the device might not be in place. You could push the paper too far forward, causing the HP all-in-one to eject blank pages.

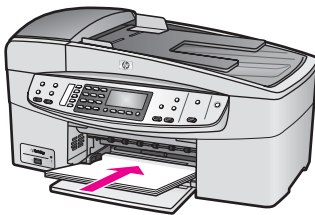

**Tip** If you are using letterhead, insert the top of the page first with the print side down. For more help on loading full-size paper and letterhead, refer to the diagram engraved in the base of the input tray.

- 4 Slide the paper-width guide inward until it stops at the edges of the paper. Do not overload the input tray; make sure the stack of paper fits within the input tray and is no higher than the top of the paper-width guide.

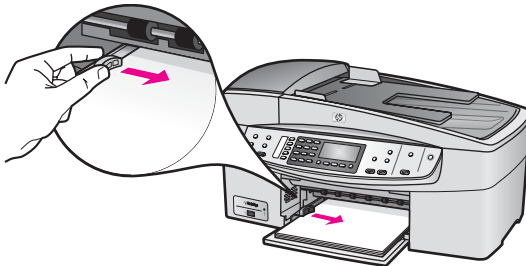

- 5 Replace the output tray.

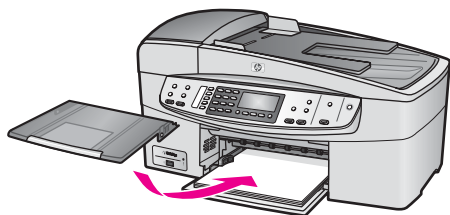

- 6 Pull the output tray extender toward you, as far as it will go. Flip the paper catch at the end of the output tray extender to open the extender the rest of the way.

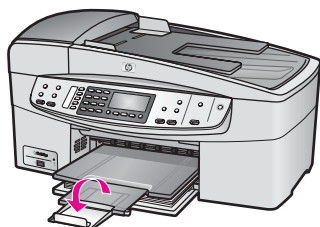

### Load 10 by 15cm (4 by 6 inch) photo paper

You can load 10 by 15 cm (4 by 6 inch) photo paper into the paper tray of your HP all-in-one. For the best results, use a recommended type of 10 by 15 cm (4 by 6 inch) photo paper. For more information, see [Recommended papers](#).

In addition, for best results, set the paper type and paper size before copying or printing. For information on changing paper settings, see the onscreen **HP Image Zone Help**.

**Tip** To help prevent rips, wrinkles, and curled or bent edges, store all paper flat in a resealable bag. If the paper is not stored properly, extreme changes in temperature and humidity might result in curled paper that does not work well in the HP all-in-one.

### To load 10 by 15 cm (4 by 6 inch) photo paper in the input tray

- 1 Remove the output tray.
- 2 Remove all paper from the input tray.
- 3 Insert the stack of photo paper into the far right side of the input tray with the short edge forward and the glossy side down. Slide the stack of photo paper forward until it stops.  
If the photo paper you are using has perforated tabs, load the photo paper so that the tabs are closest to you.
- 4 Slide the paper-width guide inward against the stack of photo paper until it stops. Do not overload the input tray; make sure the stack of photo paper fits within the input tray and is no higher than the top of the paper-width guide.



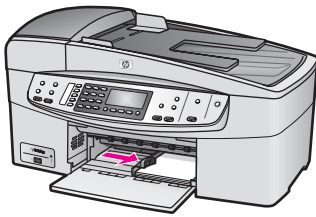

- 5 Replace the output tray.

### Load postcards or Hagaki cards

You can load postcards or Hagaki cards into the input tray of your HP all-in-one.

For the best results, set the paper type and size before printing or copying. For more information, see the onscreen **HP Image Zone Help**.

#### To load postcards or Hagaki cards in the input tray

- 1 Remove the output tray.
- 2 Remove all paper from the input tray.
- 3 Insert the stack of cards into the far right side of the input tray with the short edge forward and the print side down. Slide the stack of cards forward until it stops.
- 4 Slide the paper-width guide inward against the stack of cards until it stops.  
Do not overload the input tray; make sure the stack of cards fits within the input tray and is no higher than the top of the paper-width guide.

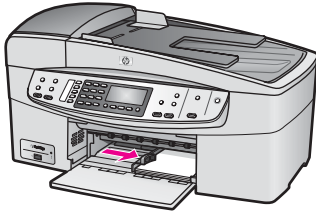

- 5 Replace the output tray.

### Load envelopes

You can load one or more envelopes into the input tray of your HP all-in-one. Do not use shiny or embossed envelopes or envelopes that have clasps or windows.

**Note** For specific details on how to format text for printing on envelopes, consult the help files in your word processing software. For best results, consider using a label for the return address on envelopes.

#### To load envelopes

- 1 Remove the output tray.
- 2 Remove all paper from the input tray.
- 3 Insert one or more envelopes into the far right side of the input tray with the envelope flaps up and to the left. Slide the stack of envelopes forward until it stops.

**Tip** For more help on loading envelopes, refer to the diagram engraved in the base of the input tray.

- 4 Slide the paper-width guide inward against the stack of envelopes until it stops. Do not overload the input tray; make sure the stack of envelopes fits within the input tray and is no higher than the top of the paper-width guide.

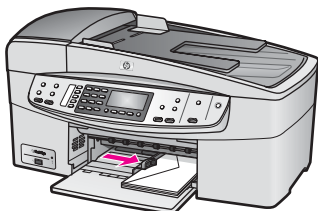

- 5 Replace the output tray.

### Load other types of paper

The following table provides guidelines for loading certain types of paper. For best results, adjust the paper settings each time you change paper sizes or paper types. For information on changing paper settings, see the onscreen **HP Image Zone Help**.

**Note** Not all paper sizes and paper types are available with all the functions on the HP all-in-one. Some paper sizes and paper types can only be used if you are starting a print job from the **Print** dialog box in a software application. They are not available for copying or faxing. Papers that are only available for printing from a software application are indicated as such, below.

| Paper     | Tips   |
|-----------|--|
| HP papers | <ul style="list-style-type: none"> <li>● HP Premium Paper: Locate the gray arrow on the nonprinting side of the paper, and then slide the paper into the input tray with the arrow side facing up.</li> <li>● HP Premium Inkjet Transparency Film: Insert the film so that the white transparency strip (with arrows and the HP logo) is on top and is going into the input tray first.</li> </ul> <p><b>Note</b> The HP all-in-one cannot automatically detect transparency film. For best results, set the paper type to transparency film before printing or copying onto transparency film.</p> <ul style="list-style-type: none"> <li>● HP Iron-On Transfers: Flatten the transfer sheet completely before using it; do not load curled sheets. (To prevent curling, keep transfer sheets sealed in the original package until you are ready to use them.) Locate the blue stripe on the nonprinting side of the transfer paper and then manually feed one sheet at a time into the input tray with the blue stripe facing up.</li> <li>● HP Matte Greeting Cards, HP Photo Greeting Cards, or HP Textured Greeting Cards: Insert a small stack of HP greeting</li> </ul> |

Chapter 5  
(continued)

| Paper   | Tips  |
|---|---|
|   | card paper into the input tray with the print side down; slide the stack of cards forward until it stops.   |
| Labels<br>(for printing from a software application only) | <p>Always use letter or A4 label sheets designed for use with HP inkjet devices (such as Avery inkjet labels), and make sure that the labels are not more than two years old. Labels on older sheets might peel off when the paper is pulled through the HP all-in-one, causing subsequent paper jams.</p> <ol style="list-style-type: none"> <li>1 Fan the stack of labels to make sure none of the pages are sticking together.</li> <li>2 Place a stack of label sheets on top of full-size plain paper in the input tray, label side down. Do not insert labels one sheet at a time.</li> </ol> |

## Avoid paper jams

To help avoid paper jams, follow these guidelines:

- Prevent curled or wrinkled paper by storing all unused paper flat in a resealable bag.
- Remove printed papers from the output tray frequently.
- Ensure that paper loaded in the input tray lays flat and the edges are not bent or torn.
- Do not combine different paper types and paper sizes in the input tray; the entire stack of paper in the input tray must be the same size and type.
- Adjust the paper-width guide in the input tray to fit snugly against all paper. Make sure the paper-width guide does not bend the paper in the input tray.
- Do not force paper too far forward in the input tray.
- Use paper types that are recommended for your HP all-in-one. For more information, see [Choose papers for printing and copying](#).

For more information about clearing paper jams, see [Paper troubleshooting](#).

## 6 Use a PictBridge camera

The HP all-in-one supports the PictBridge standard, which lets you connect any PictBridge-compatible digital camera to the camera port and print JPEG photos contained on the memory card in the camera. The photos are printed directly from the digital camera. For more information about printing from your camera, see the documentation that came with your digital camera.

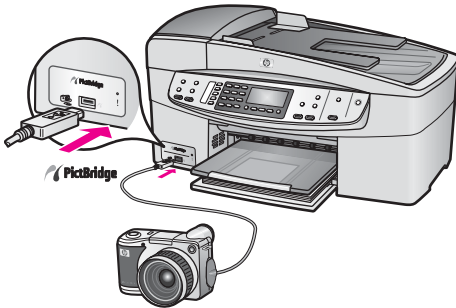

### To print photos from a PictBridge-compatible camera

- 1 Make sure the HP all-in-one is turned on and that the initialization process is finished.
- 2 Connect your PictBridge-compatible digital camera to the camera port on the front of your HP all-in-one using the USB cable supplied with your camera.
- 3 Turn on your camera and make sure it is in PictBridge mode.

**Note** When the camera is connected correctly, the status light next to the camera port blinks while the camera is being accessed. The light also stops blinking and stays lit when printing from the camera.

If the camera is not PictBridge-compliant or is not in PictBridge mode, the status light blinks amber and an error message displays on your computer monitor (if you have the HP all-in-one software installed). Disconnect the camera, correct the problem on the camera and reconnect. For more information about PictBridge camera port troubleshooting, see the **6200 series Troubleshooting** section in the **HP Image Zone Help**.

After you successfully connect your PictBridge-compliant camera to the HP all-in-one, you can print your photos. Make sure the size of the paper loaded in the HP all-in-one matches the setting on your camera. If the paper size setting on your camera is set to the default, the HP all-in-one uses the paper that is currently loaded in the input tray. Refer to the user guide that came with your camera for detailed information on printing from the camera.

**Tip** If your digital camera is an HP model that does not support PictBridge, you can still print directly to the HP all-in-one. Connect the camera to the USB port on the back of the HP all-in-one instead of to the camera port. Direct-printing from the back port works with HP digital cameras only.



# 7 Use the copy features

The HP all-in-one allows you to produce high-quality color and black-and-white copies on a variety of paper types, including transparencies. You can enlarge or reduce the size of an original to fit a specific paper size, adjust the darkness and color intensity of the copy, and use special features to make high-quality copies of photos, including 10 by 15 cm (4 by 6 inch) borderless copies.

This chapter provides instructions for increasing copy speed, enhancing copy quality, setting the number of copies to print, guidelines for choosing the best paper type and size for your job, and making iron-on transfers.

**Tip** For the best copy performance on standard copy projects, set the paper size to **Letter** or **A4**, the paper type to **Plain Paper**, and the copy quality to **Fast**.

For information on setting the paper size, see [Set the copy paper size](#).

For information on setting the paper type, see [Set the copy paper type](#).

For information on setting the copy quality, see [Increase copy speed or quality](#).

You can learn how to perform photo copy projects, such as making borderless copies of photos, enlarging and reducing the copies of photos to suit your preference, making multiple copies of photos on a page, and making quality enhancements to copies of faded photos.



Make a 10 by 15 cm (4 by 6 inch) borderless copy of a photo.



Copy a 10 by 15 cm (4 by 6 inch) photo onto a full-size page.



Enhance light areas of your copy.

## Set the copy paper size

You can set the paper size on your HP all-in-one. The paper size you select should match what is loaded in your input tray. The default paper size setting for copying is **Automatic**, which causes the HP all-in-one to detect the size of paper in the input tray.

| Paper type                             | Suggested paper size settings   |
|--|---|
| Copier, multi-purpose, or plain papers | Letter or A4  |
| Inkjet papers                          | Letter or A4  |
| Iron-on transfers                      | Letter or A4  |
| Letterhead                             | Letter, Legal or A4   |
| Photo papers                           | 10x15 cm or 10x15 cm Borderless<br>4x6 inches or 4x6 Borderless<br>5x7 inches or 5x7 Borderless |

(continued)

| Paper type         | Suggested paper size settings   |
|--------------------|---|
|                    | Letter or Letter Borderless<br>A4 or A4 Borderless<br>L-size or L-size Borderless |
| Hagaki cards       | Hagaki or Hagaki Borderless   |
| Transparency films | Letter or A4  |

### To set the paper size from the control panel

- 1 In the Copy area, press **Menu** until **Copy Paper Size** appears.
- 2 Press **▶** until the appropriate paper size appears.
- 3 Press **OK** to choose the displayed paper size.

## Set the copy paper type

You can set the paper type on your HP all-in-one. The default paper type setting for copying is **Automatic**, which causes the HP all-in-one to detect the type of paper in the input tray.

If you copy onto special papers, or if you experience poor print quality by using the **Automatic** setting, you can set the paper type manually.

### To set the paper type from the control panel

- 1 In the Copy area, press **Menu** until **Copy Paper Type** appears.
- 2 Press **▶** until the paper type setting you want appears, and then press **OK**.

Refer to the following table to determine which paper type setting to choose based on the paper loaded in the input tray.

| Paper type                              | Control panel setting |
|---|-----------------------|
| Copier paper or letterhead              | Plain Paper           |
| HP Bright White Paper                   | Plain Paper           |
| HP Premium Plus Photo Paper, Glossy     | Premium Photo         |
| HP Premium Plus Photo Paper, Matte      | Premium Photo         |
| HP Premium Plus 4 by 6 inch Photo Paper | Premium Photo         |
| HP Photo Paper                          | Photo Paper           |
| HP Everyday Photo Paper                 | Everyday Photo        |
| HP Everyday Photo Paper, Semi Gloss     | Everyday Matte        |
| Other photo paper                       | Other Photo           |
| HP Iron-On Transfer                     | Iron-On               |
| HP Iron-On Transfer                     | Iron-On Mirrored      |

(continued)

| Paper type  | Control panel setting |
|---|-----------------------|
| HP Premium Paper                                    | Premium Inkjet        |
| Other inkjet paper                                  | Premium Inkjet        |
| HP Professional Brochure & Flyer Paper (Glossy)     | Brochure Glossy       |
| HP Professional Brochure & Flyer Paper (Matte)      | Brochure Matte        |
| HP Premium or Premium Plus Inkjet Transparency Film | Transparency          |
| Other transparency film                             | Transparency          |
| Plain Hagaki  | Plain Paper           |
| Glossy Hagaki                                       | Premium Photo         |
| L (Japan only)                                      | Premium Photo         |

## Increase copy speed or quality

The HP all-in-one provides three options that affect copy speed and quality:

- **Best** produces the highest quality for all paper and eliminates the banding (striping) effect that sometimes occurs in solid areas. **Best** copies more slowly than the other quality settings.
- **Normal** delivers high-quality output and is the recommended setting for most of your copying. **Normal** copies faster than **Best**.
- **Fast** copies faster than the **Normal** setting. The text is comparable to the quality of the **Normal** setting, but the graphics might be lower quality. The **Fast** setting uses less ink and extends the life of your print cartridges.

### To change the copy quality from the control panel

- 1 Make sure you have paper loaded in the input tray.
- 2 Load your original face down on the right front corner of the glass or face up in the document feeder tray.  
If you use the document feeder tray, place the pages so that the top of the document goes in first.
- 3 In the Copy area, press **Quality** until you illuminate the light next to a quality setting.
- 4 Press **Start Copy Black** or **Start Copy Color**.

## Change default copy settings

When you change copy settings from the control panel, the settings apply only to the current copy job. To apply copy settings to all future copy jobs, you can save the settings as defaults.

When you change copy settings from the control panel or the **HP Director**, the settings apply only to the current copy job. To apply copy settings to all future copy jobs, you can save the settings as defaults.



### To set default copy settings from the control panel

- 1 Make any needed changes to the Copy settings.
- 2 In the Copy area, press **Menu** until **Set New Defaults** appears.
- 3 Press **►** until **Yes** appears.
- 4 Press **OK** to accept the settings as the new default settings.

The settings you specify here are only saved on the HP all-in-one. They do not adjust the settings in the software. You can save your most frequently used settings by using the HP Image Zone software that came with your HP all-in-one. For more information, see the onscreen **HP Image Zone Help**.

## Make multiple copies of the same original

You can set the number of copies that you want to print by using the **Number of Copies** option.

- 1 Make sure you have paper loaded in the input tray.
- 2 Load your original face down on the right front corner of the glass or face up in the document feeder tray.  
If you use the document feeder tray, place the pages so that the top of the document goes in first.
- 3 In the Copy area, press **Menu** until **Number of Copies** appears.
- 4 Press **►** or use the keypad to enter the number of copies, up to the maximum.  
(The maximum number of copies varies by model.)

**Tip** If you hold down either of the arrow buttons, the number of copies changes by increments of 5 to make it easier to set a large number of copies.

- 5 Press **Start Copy Black** or **Start Copy Color**.

In this example, the HP all-in-one makes three copies of the original 10 by 15 cm (4 by 6 inch) photo.

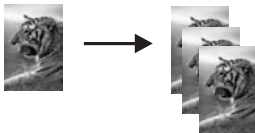

## Copy a two-page black-and-white document

You can use the HP all-in-one to copy a single- or multiple-page document in color or black and white. In this example, the HP all-in-one is used to copy a two-page black-and-white original.

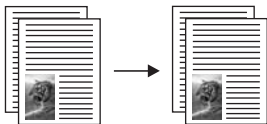

### To copy a two-page document from the control panel

- 1 Make sure you have paper loaded in the input tray.
- 2 Load your letter- or A4-sized originals in the document feeder tray. Place the pages so that the top of the document goes in first.
- 3 Press **Start Copy Black**.

## Make a 10by 15cm (4by 6inch) borderless copy of a photo

For the best quality when copying a photo, load photo paper in the input tray and change your copy settings for the correct paper type and photo enhancement. You might also want to use the photo print cartridge for superior print quality. With the tri-color and photo print cartridges installed, you have a six-ink system. See [Use a photo print cartridge](#) for more information.

### To copy a photo from the control panel

- 1 Load 10 by 15 cm (4 by 6 inch) photo paper in the input tray.

**Tip** When making borderless copies, you must have photo paper (or other specialty paper) loaded.

- 2 Load your original photo face down on the right front corner of the glass. Position the photo on the glass so the long edge of the photo is along the front edge of the glass.
- 3 Press **Start Copy Color**.

The HP all-in-one makes a 10 by 15 cm (4 by 6 inch) borderless copy of your original photo, as shown below.



**Tip** If the output is not borderless, then set the paper size to **10x15 cm Borderless** or **4x6 Borderless**, set the paper type to **Photo Paper**, set the **Photo** enhancement, and then try again.

For more information on setting the paper size, see [Set the copy paper size](#).

For information on setting the paper type, see [Set the copy paper type](#).

For information on setting the **Photo** enhancement, see [Enhance light areas of your copy](#).

## Copy a 10by 15cm (4by 6inch) photo onto a full-size page

You can use the **Fill Entire Page** setting to enlarge or reduce your original to fill the printable area of the paper size loaded in the input tray. In this example, **Fill Entire Page** is used to enlarge a 10 by 15 cm (4 by 6 inch) photo to create a full-size borderless copy. When copying a photo, you might want to use the photo print cartridge

for superior print quality. With the tri-color and photo print cartridges installed, you have a six-ink system. See [Use a photo print cartridge](#) for more information.

**Note** In order to achieve a borderless print without changing the proportions of the original, the HP all-in-one might crop some of the image around the margins. In most cases, this cropping will not be noticeable.

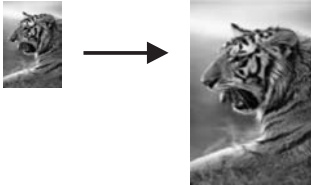

### To copy a photo onto a full-size page from the control panel

**Note** This feature will not work correctly if the glass and lid backing are not clean. For more information, see [Clean the HP all-in-one](#).

- 1 Load letter or A4 photo paper in the input tray.

**Tip** When making borderless copies, you must have photo paper (or other specialty paper) loaded.

- 2 Load your original photo face down on the right front corner of the glass. Position the photo on the glass so the long edge of the photo is along the front edge of the glass.
- 3 In the Copy area, press **Reduce/Enlarge** until **Fill Entire Page** appears.
- 4 Press **Start Copy Color**.

**Tip** If the output is not borderless, then set the paper size to **Letter Borderless** or **A4 Borderless**, set the paper type to **Photo Paper**, set the **Photo** enhancement, and then try again.

For more information on setting the paper size, see [Set the copy paper size](#).

For information on setting the paper type, see [Set the copy paper type](#).

For information on setting the **Photo** enhancement, see [Enhance light areas of your copy](#).

### Resize an original to fit onto letter or A4 paper

If the image or text on your original fills the entire sheet with no margins, use **Fit to Page** or **Full Page 91%** to reduce your original and prevent unwanted cropping of the text or images at the edges of the sheet.

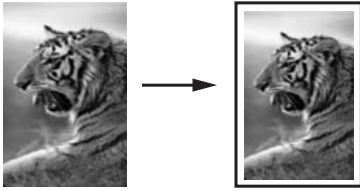

**Tip** You can also enlarge a small photo to fit within the printable area of a full-size page. In order to do this without changing the proportions of the original or cropping the edges, the HP all-in-one might leave an uneven amount of white space around the edges of the paper.

### To resize a document from the control panel

- 1 Make sure you have paper loaded in the input tray.
- 2 Load your original face down on the right front corner of the glass or face up in the document feeder tray.  
Place the page in the document feeder tray so that the top of the document goes in first.
- 3 In the Copy area, do one of the following:
  - If you loaded your original in the document feeder tray, press **Reduce/Enlarge** until **Full Page 91%** appears.
  - If you want to use **Fit to Page**, press **Reduce/Enlarge** until **Fit to Page** appears.
- 4 Press **Start Copy Black** or **Start Copy Color**.

## Resize an original using custom settings

You can use your own custom settings to reduce or enlarge a copy of a document.

### To set a custom size from the control panel

- 1 Make sure you have paper loaded in the input tray.
- 2 Load your original face down on the right front corner of the glass or face up in the document feeder tray.
- 3 In the Copy area, press **Reduce/Enlarge** until **Custom 100%** appears.
- 4 Press **▶** or use the keypad to enter a percentage to reduce or enlarge the copy, and then press **OK**.  
(The minimum and maximum percentage to resize a copy varies by model.)
- 5 Press **Start Copy Black** or **Start Copy Color**.

## Copy a legal-size document onto letter paper

You can use the **Legal > Ltr 72%** setting to reduce a copy of a legal-size document to a size that fits onto letter paper.

**Note** The percentage in the example, **Legal > Ltr 72%**, might not match the percentage that appears in the control panel display.

- 1 Make sure you have paper loaded in the input tray.

- 2 Load your legal-size document face up in the document feeder tray with the top of the page on the left.
- 3 In the Copy area, press **Reduce/Enlarge** until **Legal > Ltr 72%** appears.
- 4 Press **Start Copy Black** or **Start Copy Color**.

The HP all-in-one reduces the size of your original to fit within the printable area of the letter paper, as shown below.

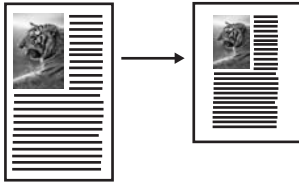

## Copy a faded original

You can use the **Lighter/Darker** option to adjust the lightness and darkness of the copies you make. You can also adjust the color intensity to make colors on your copy more vivid or more subtle.

- 1 Make sure you have paper loaded in the input tray.
- 2 Load your original face down on the right front corner of the glass or face up in the document feeder tray.

If you use the document feeder tray, place the pages so that the top of the document goes in first.

- 3 In the Copy area, press **Menu** until **Lighter/Darker** appears.
- 4 Press **▶** to darken the copy, and then press **OK**.

**Note** You can also press **◀** to lighten the copy.

- 5 In the Copy area, press **Menu** until **Color Intensity** appears. The range of color intensity values appears as a scale on the control panel display.
- 6 Press **▶** to make the image more vivid, and then press **OK**.

**Note** You can also press **◀** to make the image more pale.

- 7 Press **Start Copy Black** or **Start Copy Color**.

## Copy a document that has been faxed several times

You can use the **Enhancements** feature to adjust the quality of text documents by sharpening edges of black text or adjust photographs by enhancing light colors that might otherwise appear white.

The **Mixed** enhancement is the default option. Use the **Mixed** enhancement to sharpen edges of most originals.

### To copy a blurred document

- 1 Make sure you have paper loaded in the input tray.
- 2 Load your original face down on the right front corner of the glass or face up in the document feeder tray.

If you use the document feeder tray, place the pages so that the top of the document goes in first.

- 3 In the Copy area, press **Menu** until **Enhancements** appears.
- 4 Press **▶** until the **Text** setting appears, and then press **OK**.
- 5 Press **Start Copy Black** or **Start Copy Color**.

If any of the following occur, turn off **Text** enhancement by selecting **Photo** or **None**:

- Stray dots of color surround some text on your copies
- Large, black typefaces look splotchy (not smooth)
- Thin, colored objects or lines contain black sections
- Horizontal grainy or white bands appear in light- to medium-gray areas

## Enhance light areas of your copy

You can use **Photo** enhancements to enhance light colors that might otherwise appear white. You can also use **Photo** enhancements to eliminate or reduce any of the following that might occur when copying with **Text** enhancements:

- Stray dots of color surround some text on your copies
- Large, black typefaces look splotchy (not smooth)
- Thin, colored objects or lines contain black sections
- Horizontal grainy or white bands appear in light- to medium-gray areas

### To copy an overexposed photo

- 1 Make sure you have paper loaded in the input tray.
- 2 Load your original photo face down on the right front corner of the glass. Position the photo on the glass so the long edge of the photo is along the front edge of the glass.
- 3 In the Copy area, press **Menu** until **Enhancements** appears.
- 4 Press **▶** until the **Photo** enhancement setting appears, and then press **OK**.
- 5 Press **Start Copy Color**.

It is easy to set **Enhancement** settings for photos and other documents you copy by using the **HP Image Zone** software that came with your HP all-in-one. With one click of your mouse button, you can set a photo to copy with **Photo** enhancements, a text document to copy with **Text** enhancements, or a document that contains both images and text to copy with both **Photo** and **Text** enhancements turned on. For more information, see the onscreen **HP Image Zone Help**.

## Prepare a color iron-on transfer

You can copy an image or text onto an iron-on transfer, then iron it onto a T-shirt, pillow cover, place mat, or other piece of fabric.

**Tip** Practice applying an iron-on transfer on an old garment first.

- 1 Load the iron-on transfer paper in the input tray.
- 2 Load your original face down on the right front corner of the glass. If you are copying a photo, position the photo on the glass so the long edge of the photo is along the front edge of the glass.
- 3 In the Copy area, press **Menu** until **Copy Paper Type** appears.
- 4 Press **▶** until **Iron-On** or **Iron-On Mirrored** appears, and then press **OK**.

**Note** Select **Iron-On** as the paper type for dark-colored fabrics, and **Iron-On Mirrored** for white and light-colored fabrics.

- 5 Press **Start Copy Black** or **Start Copy Color**.

**Note** When you select **Iron-On Mirrored** as the paper type, the HP all-in-one copies a mirror image of your original automatically so that it will appear properly when you iron it onto fabric.

## Stop copying

- To stop copying, press **Cancel** on the control panel.

# 8 Use the scan features

Scanning is the process of converting text and pictures into an electronic format for your computer. You can scan just about anything: photos, magazine articles, and text documents, as long as you are careful not to scratch the glass on your HP all-in-one.

You can use the scanning features of your HP all-in-one to do the following:

- Scan text from an article into your word processor and quote it in a report.
- Print business cards and brochures by scanning a logo and using it in your publishing software.
- Send photos to friends and relatives by scanning your favorite prints and including them in e-mail messages.
- Create a photographic inventory of your house or office.
- Archive treasured photos in an electronic scrapbook.

**Note** Scanning text (also known as optical character recognition or OCR) lets you bring the content of magazine articles, books, and other printed matter into your favorite word processor (and many other programs) as fully editable text. Learning to do OCR right is important if you want to obtain the best results. Do not expect scanned text documents to be letter-perfect the first time you use your OCR software. Using OCR software is an art that takes time and practice to master.

For more information about scanning documents, especially documents containing both text and graphics, see the documentation that came with your OCR software.

To use the scan features, your HP all-in-one and computer must be connected and turned on. The HP all-in-one software must also be installed and running on your computer prior to scanning. To verify that the HP all-in-one software is running on a Windows PC, look for the HP all-in-one icon in the system tray at the lower right side of the screen, near the time. On a Macintosh, the HP all-in-one software is always running.

**Note** Closing the HP Windows system tray icon can cause your HP all-in-one to lose some of its scan functionality and result in the **No Connection** error message. If this happens, you can restore full functionality by restarting your computer or by starting the **HP Image Zone** software.

For information about how to scan from the computer, and how to adjust, resize, rotate, crop, and sharpen your scans, see the onscreen **HP Image Zone Help** that came with your software.

This chapter contains information on: sending a scan to and from different destinations, and adjusting the preview image.

## Scan to an application

Follow these steps if your HP all-in-one is directly connected to a computer through a USB cable.

You can scan originals placed on the glass directly from the control panel.



**Note** The menus shown in this section may vary in content depending on your computer's operating system and which applications you set up as scan destinations in the **HP Image Zone**.

### To send a scan to an application

- 1 Load your original face down in the right front corner of the glass.
- 2 In the Scan area, press the **Scan To** button.  
The **Scan To** menu appears, listing destinations, including applications, for anything you scan. The default destination is whichever one you selected the last time you used this menu. You designate which applications and other destinations appear on the **Scan To** menu by using the **HP Image Zone** on your computer.
- 3 To select an application to receive the scan, use ◀ or ▶ to select it, and then press **OK** or **Start Scan**.  
A preview image of the scan appears in the **HP Scan** window on the computer, where you can edit it.  
For more information about editing a preview image, see the onscreen **HP Image Zone Help** that came with your software.
- 4 Make any edits to the preview image in the **HP Scan** window. When you have finished, click **Accept**.  
The HP all-in-one sends the scan to the selected application. For example, if you chose the **HP Image Zone** software (Windows) or **JPEG to HP Gallery** (Macintosh), it automatically opens and displays the image.

The **HP Image Zone** has many tools that you can use to edit your scanned image. You can improve the overall image quality by adjusting the brightness, sharpness, color tone, or saturation. You can also crop, straighten, rotate, or resize the image. When the scanned image looks just the way you want it, you can open it in another application, send it through e-mail, save it to a file, or print it. For more information about using the **HP Image Zone**, see the onscreen **HP Image Zone Help**.

## Stop scanning

- To stop scanning, press **Cancel** on the control panel.

# 9 Print from your computer

The HP all-in-one can be used with any software application that allows printing. The instructions vary slightly depending on whether you are printing from a Windows PC or a Macintosh. Make sure you follow the instructions for your operating system in this chapter.

In addition to the printing capabilities described in this chapter, you can print special print jobs such as borderless prints and newsletters; print images directly from a digital camera that supports PictBridge; and use scanned images in printing projects in the **HP Image Zone**.

- For more information on printing from a digital camera, see [Use a PictBridge camera](#).
- For more information on performing special print jobs or printing images in the **HP Image Zone**, see the onscreen **HP Image Zone Help**.

## Print from a software application

Most print settings are automatically handled by the software application you are printing from or by HP ColorSmart technology. You need to change the settings manually only when you change print quality, print on specific types of paper or transparency film, or use special features.

### To print from the software application you used to create your document (Windows users)

- 1 Make sure you have paper loaded in the input tray.
- 2 On the **File** menu in your software application, click **Print**.
- 3 Select the HP all-in-one as the printer.
- 4 If you need to change settings, click the button that opens the **Properties** dialog box.

Depending on your software application, this button might be called **Properties**, **Options**, **Printer Setup**, or **Printer**.

- 5 Select the appropriate options for your print job by using the features available in the **Paper/Quality**, **Finishing**, **Effects**, **Basics**, and **Color** tabs.

**Tip** You can easily select the appropriate options for your print job by choosing one of the predefined print tasks on the **Printing Shortcuts** tab. Click a type of print task in the **What do you want to do?** list. The default settings for that type of print task are set, and summarized on the **Printing Shortcuts** tab. If necessary, you can adjust the settings here, or you can make your changes on the other tabs in the **Properties** dialog box.

- 6 Click **OK** to close the **Properties** dialog box.
- 7 Click **Print** or **OK** to begin printing.

### To print from the software application you used to create your document (Macintosh users)

- 1 Make sure you have paper loaded in the input tray.

- 2 Select the HP all-in-one in the **Chooser** (OS 9), **Print Center** (OS 10.2 or earlier), or **Printer Setup Utility** (OS 10.3 or later) before you begin printing.
- 3 From the **File** menu in your software application, choose **Page Setup**. The **Page Setup** dialog box appears, allowing you to specify the paper size, orientation, and scaling.
- 4 Specify the page attributes:
  - Choose the paper size.
  - Select the orientation.
  - Enter the scaling percentage.

**Note** For OS 9, the **Page Setup** dialog box also includes options to print a mirrored (or reversed) version of the image, and to adjust the page margins for two-sided printing.

- 5 Click **OK**.
- 6 From the **File** menu in your software application, choose **Print**. The **Print** dialog box appears. If you are using OS 9, the **General** panel opens. If you are using OS X, the **Copies & Pages** panel opens.
- 7 Change the print settings for each option in the pop-up menu, as appropriate for your project.
- 8 Click **Print** to begin printing.

## Change the print settings

You can customize the print settings of the HP all-in-one to handle nearly any print task.

### Windows users

Before you change print settings, you should decide if you want to change the settings for the current print job only, or if you want to make the settings the defaults for all future print jobs. How you display print settings depends on whether or not you want to apply the change to all future print jobs or just to the current print job.

#### To change the print settings for all future jobs

- 1 In the **HP Director**, click **Settings**, point to **Print Settings**, and then click **Printer Settings**.
- 2 Make changes to the print settings, and click **OK**.

#### To change the print settings for the current job

- 1 On the **File** menu in your software application, click **Print**.
- 2 Make sure the HP all-in-one is the selected printer.
- 3 Click the button that opens the **Properties** dialog box. Depending on your software application, this button might be called **Properties**, **Options**, **Printer Setup**, or **Printer**.
- 4 Make changes to the print settings, and click **OK**.
- 5 Click **Print** or **OK** in the **Print** dialog box to print the job.

### Macintosh users

Use the **Page Setup** and **Print** dialog boxes to change the settings for your print job. Which dialog box you use depends on which setting you want to change.

### To change the paper size, orientation, or scaling percentage

- 1 Select the HP all-in-one in the **Chooser** (OS 9), **Print Center** (OS 10.2 or earlier), or **Printer Setup Utility** (OS 10.3 or later) before you begin printing.
- 2 From the **File** menu in your software application, choose **Page Setup**.
- 3 Make changes to the paper size, orientation, and scaling percentage settings, and click **OK**.

### To change all other print settings

- 1 Select the HP all-in-one in the **Chooser** (OS 9), **Print Center** (OS 10.2 or earlier), or **Printer Setup Utility** (OS 10.3 or later) before you begin printing.
- 2 From the **File** menu in your software application, choose **Print**.
- 3 Make changes to the print settings, and click **Print** to print the job.

## Stop a print job

Although you can stop a print job from either the HP all-in-one or the computer, we recommend you stop it from the HP all-in-one for best results.

### To stop a print job from the HP all-in-one

- Press **Cancel** on the control panel. Look for the **Print Cancelled** message on the control panel display. If the message does not appear, press **Cancel** again.



# 10 Fax setup

After completing all steps in the Setup Guide, use the instructions in this chapter to complete your fax setup. Please keep your Setup Guide for later use.

In this chapter, you will learn how to set up your HP all-in-one so that faxing works successfully with equipment and services you might already have on the same phone line as your HP all-in-one.

Before you begin setting up your HP all-in-one for faxing, determine which kind of phone system your country/region uses. The instructions for setting up your HP all-in-one for faxing differ depending whether you have a serial or parallel phone system.

- If the connector type on your shared telephone equipment (modems, phones, and answering machines) does not allow a physical connection to the "2-EXT" port on your HP all-in-one and instead must be connected at the telephone wall jack, you probably have a serial-type telephone system. Check the table below to make sure that your country/region does not appear in this list. If you are unsure which kind of telephone system you have (serial or parallel), check with your telephone company. This type of phone system uses a 4-wire phone cord to connect the HP all-in-one to the telephone wall jack.
- If your country/region is listed in the table, you probably have a parallel-type telephone system. This type of phone system uses a 2-wire phone cord to connect the HP all-in-one to the telephone wall jack.

|           |               |              |
|-----------|---------------|--------------|
| Argentina | Australia     | Brazil       |
| Canada    | Chile         | China        |
| Colombia  | Greece        | India        |
| Indonesia | Ireland       | Japan        |
| Korea     | Latin America | Malaysia     |
| Mexico    | Philippines   | Poland       |
| Portugal  | Russia        | Saudi Arabia |
| Singapore | Spain         | Taiwan       |
| Thailand  | USA           | Venezuela    |
| Vietnam   |               |              |

**Tip** You can also check the end of the phone cord that came in the box with your HP all-in-one. If the phone cord appears to have two wires, you have a 2-wire phone cord. If the phone cord has four wires, you have a 4-wire phone cord. The graphic below shows the differences between the phone cords.

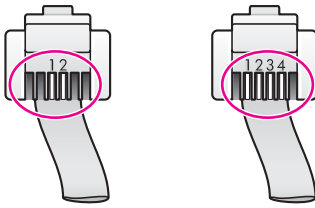

## Choose the right fax setup for your home or office

To fax successfully, you need to know what types of equipment and services (if any) share the same phone line with your HP all-in-one. This is important because you might need to connect some of your existing office equipment directly to your HP all-in-one, and you might also need to change some fax settings before you can fax successfully.

To determine the best way to set up the HP all-in-one in your home or office, first read through the questions in this section and record your answers. Next, refer to the table in the following section and choose the recommended setup case based on your answers.

Make sure to read and answer the following questions in the order they are presented.

- 1 Do you have a digital subscriber line (DSL) service through your telephone company?
  - Yes, I have DSL.
  - No.

If you answered Yes, proceed directly to [Case B: Set up your HP all-in-one with DSL](#). You do not need to continue answering questions.

If you answered No, please continue answering questions.

- 2 Do you have a private branch exchange (PBX) phone system or an integrated services digital network (ISDN) system?
  - If you answered Yes, proceed directly to [Case C: Set up your HP all-in-one with a PBX phone system or an ISDN line](#). You do not need to continue answering questions.
  - If you answered No, please continue answering questions.
- 3 Do you subscribe to a distinctive ring service through your telephone company that provides multiple phone numbers with different ring patterns?
  - Yes, I have distinctive ring.
  - No.

If you answered Yes, proceed directly to [Case D: Fax with a distinctive ring service on the same line](#). You do not need to continue answering questions.

If you answered No, please continue answering questions.

Are you unsure if you have distinctive ring? Many phone companies offer a distinctive ring feature that allows you to have several phone numbers on one phone line.

When you subscribe to this service, each phone number will have a different ring pattern. For example, you can have single, double, and triple rings for the different numbers. You might assign one phone number with a single ring to your voice calls, and another phone number with double rings to your fax calls. This allows you to tell the difference between voice and fax calls when the phone rings.

- 4 Do you receive voice calls at the same phone number you will use for fax calls on your HP all-in-one?
- Yes, I receive voice calls.
  - No.

Please continue answering questions.

- 5 Do you have a PC modem on the same phone line as your HP all-in-one?
- Yes, I have a PC modem.
  - No.

If you answer Yes to any of the following questions, you are using a PC modem:

- Do you send and receive faxes directly to and from your computer software programs through a dial-up connection?
- Do you send and receive e-mail messages on your computer through a dial-up connection?
- Do you access the Internet from your computer through a dial-up connection?

Please continue answering questions.

- 6 Do you have an answering machine that answers voice calls at the same phone number you will use for fax calls on your HP all-in-one?
- Yes, I have an answering machine.
  - No.

Please continue answering questions.

- 7 Do you subscribe to a voice mail service through your telephone company at the same phone number you will use for fax calls on your HP all-in-one?
- Yes, I have a voice mail service.
  - No.

After you have completed answering the questions, proceed to the next section to select your fax setup case.

## Select your fax setup case

Now that you have answered all of the questions about the equipment and services that share the phone line with your HP all-in-one, you are ready to choose the best setup case for your home or office.

From the first column in the following table, choose the combination of equipment and services applicable to your home or office setting. Then look up the appropriate setup case in the second or third column based on your phone system. Step-by-step instructions are included for each case later in this chapter.

If you have answered all of the questions in the previous section and have none of the described equipment or services, choose "None" from the first column in the table.

**Note** If your home or office setup is not described in this chapter, set up the HP all-in-one as you would a regular analog phone. Make sure you use the phone cord supplied in the box to connect one end to your telephone wall jack and the other end to the port labeled "1-LINE" on the back of your HP all-in-one. If you use another phone cord, you might experience problems sending and receiving faxes.



| Other equipment/services sharing your fax line  | Recommended fax setup for parallel-type phone systems                     | Recommended fax setup for serial-type phone systems                       |
|---|---|---|
| None<br>(You answered No to all questions.)   | Case A: Separate fax line (no voice calls received)                       | Case A: Separate fax line (no voice calls received)                       |
| DSL service<br>(You answered Yes to question 1 only.)   | Case B: Set up your HP all-in-one with DSL                                | Case B: Set up your HP all-in-one with DSL                                |
| PBX or ISDN system<br>You answered Yes to question 2 only.)                                       | Case C: Set up your HP all-in-one with a PBX phone system or an ISDN line | Case C: Set up your HP all-in-one with a PBX phone system or an ISDN line |
| Distinctive ring service<br>(You answered Yes to question 3 only.)                                | Case D: Fax with a distinctive ring service on the same line              | Case D: Fax with a distinctive ring service on the same line              |
| Voice calls<br>(You answered Yes to question 4 only.)   | Case E: Shared voice/fax line   | Case E: Shared voice/fax line   |
| Voice calls and voice mail service<br>(You answered Yes to questions 4 and 7 only.)               | Case F: Shared voice/fax line with voice mail                             | Case F: Shared voice/fax line with voice mail                             |
| PC modem<br>(You answered Yes to question 5 only.)  | Case G: Fax line shared with PC modem (no voice calls received)           | Not applicable.   |
| Voice calls and PC modem<br>(You answered Yes to questions 4 and 5 only.)                         | Case H: Shared voice/fax line with PC modem                               | Not applicable.   |
| Voice calls and answering machine<br>(You answered Yes to questions 4 and 6 only.)                | Case I: Shared voice/fax line with answering machine                      | Not applicable.   |
| Voice calls, PC modem, and answering machine<br>(You answered Yes to questions 4, 5, and 6 only.) | Case J: Shared voice/fax line with PC modem and answering machine         | Not applicable.   |
| Voice calls, PC modem, and voice mail service   | Case K: Shared voice/fax line with PC modem and voice mail                | Not applicable.   |

(continued)

| Other equipment/services sharing your fax line    | Recommended fax setup for parallel-type phone systems | Recommended fax setup for serial-type phone systems |
|---|---|---|
| (You answered Yes to questions 4, 5, and 7 only.) |   |   |

## Case A: Separate fax line (no voice calls received)

If you have a separate phone line on which you receive no voice calls, and you have no other equipment connected on this phone line, set up your HP all-in-one as described in this section.

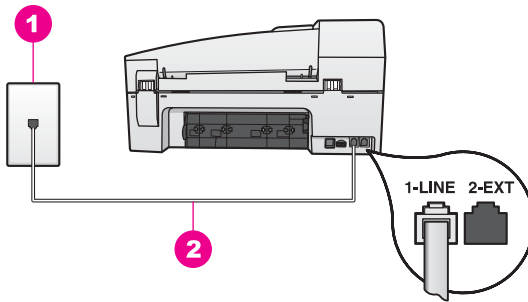

### Back view of the HP all-in-one

|   |   |
|---|---|
| 1 | Telephone wall jack   |
| 2 | Phone cord supplied in the box with your HP all-in-one connected to the "1-LINE" port |

### To set up your HP all-in-one with a separate fax line

- 1 Using the phone cord supplied in the box with your HP all-in-one, connect one end to your telephone wall jack, then connect the other end to the port labeled "1-LINE" on the back of your HP all-in-one.



**Caution** If you do not use the supplied cord to connect from the telephone wall jack to your HP all-in-one, you might not be able to fax successfully. This special phone cord is different from the phone cords you might already have in your home or office. If the supplied phone cord is too short, see [The phone cord that came with my HP all-in-one is not long enough for information on extending it.](#)

- 2 Set up the HP all-in-one to answer incoming calls automatically. Press the **Auto Answer** button until the light is on.
- 3 (Optional) Change the **Rings to Answer** setting to one ring or two rings. For information on changing this setting, see [Set the number of rings before answering.](#)
- 4 Run a fax test. For information, see [Test your fax setup.](#)

When the phone rings, your HP all-in-one will answer automatically after the number of rings you set in the **Rings to Answer** setting. Then it will begin emitting fax reception tones to the sending fax machine and receive the fax.

## Case B: Set up your HP all-in-one with DSL

If you have a DSL service through your telephone company, use the instructions in this section to connect a DSL filter between the telephone wall jack and your HP all-in-one. The DSL filter removes the digital signal that can interfere with your HP all-in-one from communicating properly with the phone line. (DSL might be called ADSL in your country/region.)

**Caution** If you have a DSL line and you do not connect the DSL filter, you will not be able to send and receive faxes with your HP all-in-one.

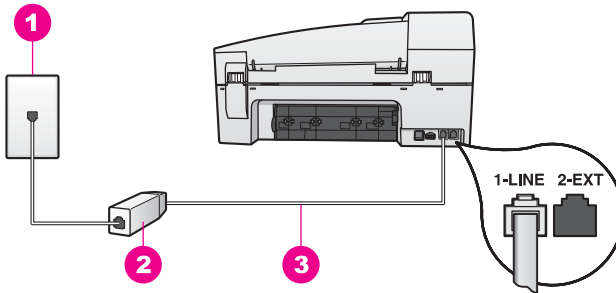

### Back view of the HP all-in-one

|   |   |
|---|---|
| 1 | Telephone wall jack   |
| 2 | DSL filter and cord supplied by your DSL provider                                     |
| 3 | Phone cord supplied in the box with your HP all-in-one connected to the "1-LINE" port |

### To set up your HP all-in-one with DSL

- 1 Obtain a DSL filter from your DSL provider.
- 2 Using the phone cord supplied in the box with your HP all-in-one, connect one end to the open port on the DSL filter, then connect the other end to the port labeled "1-LINE" on the back of your HP all-in-one.

**Caution** If you do not use the supplied cord to connect from the telephone wall jack to your HP all-in-one, you might not be able to fax successfully. This special phone cord is different from the phone cords you might already have in your home or office.

- 3 Connect the DSL filter cord to the telephone wall jack.
- 4 Run a fax test. For information, see [Test your fax setup](#).

## Case C: Set up your HP all-in-one with a PBX phone system or an ISDN line

If you are using either a PBX phone system or an ISDN converter/terminal adapter, make sure you do the following:

- If you are using either a PBX or an ISDN converter/terminal adaptor, connect the HP all-in-one to the port that is designated for fax and phone use. Also, make sure

that the terminal adapter is set to the correct switch type for your country/region, if possible.

**Note** Some ISDN systems allow you to configure the ports for specific phone equipment. For example, you might have assigned one port for telephone and Group 3 fax and another port for multiple purposes. If you have problems when connected to the fax/phone port of your ISDN converter, try using the port designated for multiple purposes; it might be labeled "multi-combi" or something similar.

- If you are using a PBX phone system, set the call waiting tone to "off."

**Caution** Many digital PBX systems include a call-waiting tone that is factory-set to "on." The call waiting tone will interfere with any fax transmission, and you will not be able to send or receive faxes with your HP all-in-one. Refer to the documentation that came with your PBX phone system for instructions on how to turn off the call-waiting tone.

- If you are using a PBX phone system, dial the number for an outside line before dialing the fax number.
- Make sure you use the supplied cord to connect from the telephone wall jack to your HP all-in-one, you might not be able to fax successfully. This special phone cord is different from the phone cords you might already have in your home or office. If the supplied phone cord is too short, see [The phone cord that came with my HP all-in-one is not long enough](#) for information on extending it.

## Case D: Fax with a distinctive ring service on the same line

If you subscribe to a distinctive ring service (through your telephone company) that allows you to have multiple phone numbers on one phone line, each with a different ring pattern, set up your HP all-in-one as described in this section.

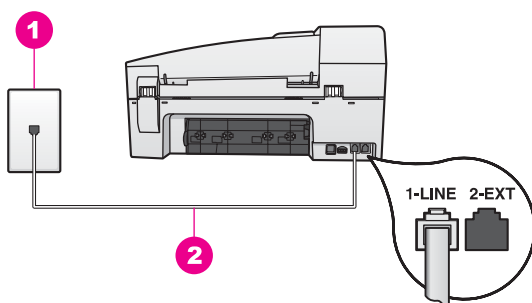

### Back view of the HP all-in-one

|   |   |
|---|---|
| 1 | Telephone wall jack   |
| 2 | Phone cord supplied in the box with your HP all-in-one connected to the "1-LINE" port |

### To set up your HP all-in-one with a distinctive ring service

- 1 Using the phone cord supplied in the box with your HP all-in-one, connect one end to your telephone wall jack, then connect the other end to the port labeled "1-LINE" on the back of your HP all-in-one.



**Caution** If you do not use the supplied cord to connect from the telephone wall jack to your HP all-in-one, you might not be able to fax successfully. This special phone cord is different from the phone cords you might already have in your home or office. If the supplied phone cord is too short, see [The phone cord that came with my HP all-in-one is not long enough](#) for information on extending it.

- 2 Set the HP all-in-one to answer incoming calls automatically. Press the **Auto Answer** button until the light is on.
- 3 Change the **Answer Ring Pattern** setting to the pattern that has been assigned to your fax number by the telephone company, for example, double rings or triple rings. For information on changing this setting, see [Change the answer ring pattern \(distinctive ringing\)](#).

**Note** Your HP all-in-one is factory-set to answer all ring patterns. If you do not set the correct ring pattern assigned to your fax number by the telephone company, your HP all-in-one might answer both voice calls and fax calls or it might not answer at all.

- 4 (Optional) Change the **Rings to Answer** setting to one ring or two rings. For information on changing this setting, see [Set the number of rings before answering](#).
- 5 Run a fax test. For information, see [Test your fax setup](#).

Your HP all-in-one will automatically answer incoming calls that have the ring pattern you selected (**Answer Ring Pattern** setting) after the number of rings you selected (**Rings to Answer** setting). Then it will begin emitting fax reception tones to the sending fax machine and receive the fax.

## Case E: Shared voice/fax line

If you receive both voice calls and fax calls at the same phone number, and you have no other office equipment (or voice mail) on this phone line, set up your HP all-in-one as described in this section.

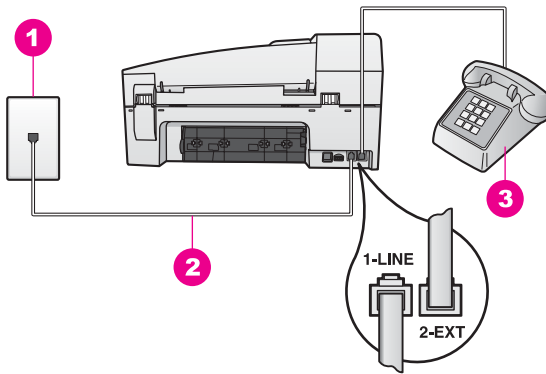

### Back view of the HP all-in-one

|   |   |
|---|---|
| 1 | Telephone wall jack   |
| 2 | Phone cord supplied in the box with your HP all-in-one connected to the "1-LINE" port |
| 3 | Optional phone for the HP all-in-one  |

### To set up your HP all-in-one with a shared voice/fax line

- Using the phone cord supplied in the box with your HP all-in-one, connect one end to your telephone wall jack, then connect the other end to the port labeled "1-LINE" on the back of your HP all-in-one.



**Caution** If you do not use the supplied cord to connect from the telephone wall jack to your HP all-in-one, you might not be able to fax successfully. This special phone cord is different from the phone cords you might already have in your home or office. If the supplied phone cord is too short, see [The phone cord that came with my HP all-in-one is not long enough for information on extending it.](#)

- Do one of the following, depending on your phone system:
  - If you have a parallel-type phone system, remove the white plug from the port labeled "2-EXT" on the back of your HP all-in-one, and then connect a phone to this port.
  - If you have a serial-type phone system, you might plug your phone directly to the telephone wall jack.
- Now you need to decide how you want the HP all-in-one to answer calls, automatically or manually:
  - If you set up the HP all-in-one to answer calls automatically, it answers all incoming calls and receives faxes. Your HP all-in-one will not be able to distinguish between fax and voice calls in this case; if you suspect the call is a voice call, you will need to answer it before the HP all-in-one answers the call. To answer fax calls automatically, press the **Auto Answer** button until the light is on.
  - If you set up the HP all-in-one to answer faxes manually, you must be available to respond in person to incoming fax calls or your HP all-in-one cannot receive faxes.

To answer fax calls manually, press the **Auto Answer** button until the light is off.

- 4 Run a fax test. For information, see [Test your fax setup](#).

If you pick up the phone before the HP all-in-one and hear fax tones from a sending fax machine, you will need to answer the fax call manually. For information, see [Receive a fax manually](#).

## Case F: Shared voice/fax line with voice mail

If you receive both voice calls and fax calls at the same phone number, and you also subscribe to a voice mail service through your telephone company, set up your HP all-in-one as described in this section.

**Note** You cannot receive faxes automatically if you have a voice mail service at the same phone number you use for fax calls. You must receive faxes manually; this means you must be available to respond in person to incoming fax calls. If you want to receive faxes automatically instead, contact your telephone company to subscribe to a distinctive ring service, or to obtain a separate phone line for faxing.

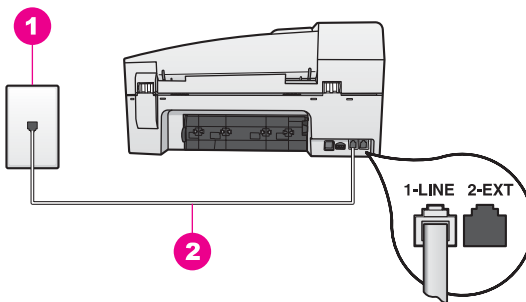

### Back view of the HP all-in-one

|   |   |
|---|---|
| 1 | Telephone wall jack   |
| 2 | Phone cord supplied in the box with your HP all-in-one connected to the "1-LINE" port |

### To set up your HP all-in-one with voice mail

- 1 Using the phone cord supplied in the box with your HP all-in-one, connect one end to your telephone wall jack, then connect the other end to the port labeled "1-LINE" on the back of your HP all-in-one.



**Caution** If you do not use the supplied cord to connect from the telephone wall jack to your HP all-in-one, you might not be able to fax successfully. This special phone cord is different from the phone cords you might already have in your home or office. If the supplied phone cord is too short, see [The phone cord that came with my HP all-in-one is not long enough for information on extending it](#).

- 2 Set up the HP all-in-one to answer incoming calls manually. Press the **Auto Answer** button until the light is off.
- 3 Run a fax test. For information, see [Test your fax setup](#).

You must be available to respond in person to incoming fax calls, or your HP all-in-one cannot receive faxes. For information on receiving faxes manually, see [Receive a fax manually](#).

## Case G: Fax line shared with PC modem (no voice calls received)

If you have a fax line on which you receive no voice calls, and you also have a PC modem connected on this line, set up your HP all-in-one as described in this section.

Since your PC modem shares the phone line with your HP all-in-one, you will not be able to use both your PC modem and your HP all-in-one simultaneously. For example, you cannot use your HP all-in-one for faxing if you are using your PC modem to send an e-mail or access the Internet.

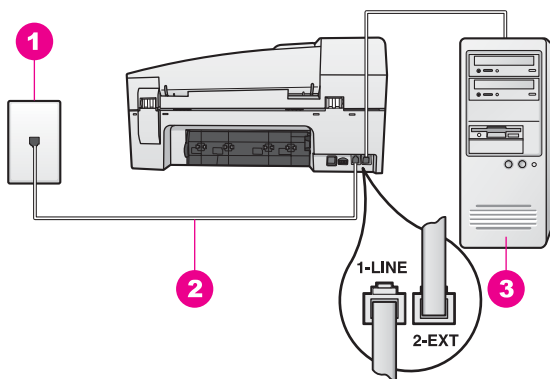

### Back view of the HP all-in-one

|   |   |
|---|---|
| 1 | Telephone wall jack   |
| 2 | Phone cord supplied in the box with your HP all-in-one connected to the "1-LINE" port |
| 3 | Computer with modem   |

### To set up your HP all-in-one with a PC modem

- 1 Remove the white plug from the port labeled "2-EXT" on the back of your HP all-in-one.
- 2 Find the phone cord that connects from the back of your computer (your PC modem) to a telephone wall jack. Disconnect the cord from the telephone wall jack and plug it into the port labeled "2-EXT" on the back of your HP all-in-one.
- 3 Using the phone cord supplied in the box with your HP all-in-one, connect one end to your telephone wall jack, then connect the other end to the port labeled "1-LINE" on the back of your HP all-in-one.



**Caution** If you do not use the supplied cord to connect from the telephone wall jack to your HP all-in-one, you might not be able to fax successfully. This special phone cord is different from the phone cords you might already have in your home or office. If the supplied phone cord is too short, see [The phone cord that came with my HP all-in-one is not long enough for information on extending it.](#)



- 4 If your PC modem software is set to receive faxes to your computer automatically, turn off that setting.



**Caution** If you do not turn off the auto fax receive setting in your PC modem software, your HP all-in-one will not be able to receive faxes.

- 5 Set up the HP all-in-one to answer incoming calls automatically. Press the **Auto Answer** button until the light is on.
- 6 (Optional) Change the **Rings to Answer** setting to one ring or two rings. For information on changing this setting, see [Set the number of rings before answering](#).
- 7 Run a fax test. For information, see [Test your fax setup](#).

When the phone rings, your HP all-in-one will answer automatically after the number of rings you set in the **Rings to Answer** setting. Then it will begin emitting fax reception tones to the sending fax machine and receive the fax.

## Case H: Shared voice/fax line with PC modem

If you receive both voice calls and fax calls at the same phone number, and you also have a PC modem connected on this phone line, set up your HP all-in-one as described in this section.

Since your PC modem shares the phone line with your HP all-in-one, you will not be able to use both your PC modem and your HP all-in-one simultaneously. For example, you cannot use your HP all-in-one for faxing if you are using your PC modem to send an e-mail or access the Internet.

There are two different ways to set up your HP all-in-one with your computer based on the number of phone ports on your computer. Before you begin, check your computer to see if it has one or two phone ports:

- If your computer has only one phone port, see the next section, [Set up your HP all-in-one to a computer with one phone port](#). You will need to purchase a parallel splitter (also called a coupler) in order to send and receive faxes successfully and use your PC modem. (A parallel splitter has one RJ-11 port on the front and two RJ-11 ports on the back. Do not use a 2-line phone splitter, a serial splitter, or a parallel splitter which has two RJ-11 ports on the front and a plug on the back.) You will also need three additional phone cords. You can purchase a parallel splitter and additional phone cords from an electronics store that carries phone accessories.
- If your computer has two phone ports, see [Set up your HP all-in-one to a computer with two phone ports](#).

### Set up your HP all-in-one to a computer with one phone port

This section describes how to set up your HP all-in-one with a PC modem if your computer has only one phone port.

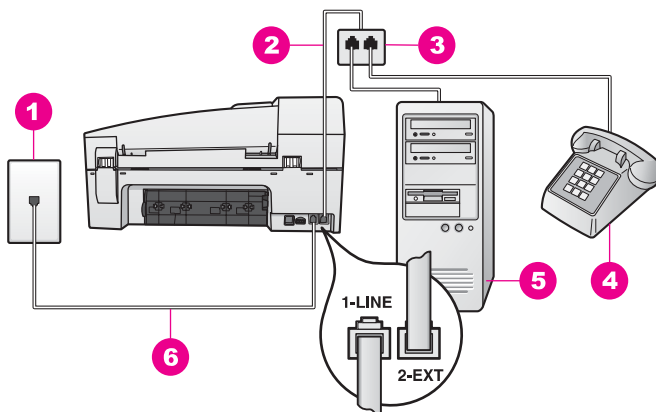

### Back view of the HP all-in-one

|   |   |
|---|---|
| 1 | Telephone wall jack   |
| 2 | Phone cord connected to the "2-EXT" port  |
| 3 | Parallel splitter   |
| 4 | Telephone   |
| 5 | Computer with modem   |
| 6 | Phone cord supplied in the box with your HP all-in-one connected to the "1-LINE" port |

### To set up your HP all-in-one to a computer with one phone port

- 1 Find the phone cord that connects from the back of your computer (your PC modem) to a telephone wall jack. Disconnect the cord from the telephone wall jack and plug it into the parallel splitter on the side with two phone ports.
- 2 Using the phone cord supplied in the box with your HP all-in-one, connect one end to your telephone wall jack, then connect the other end to the port labeled "1-LINE" on the back of your HP all-in-one.



**Caution** If you do not use the supplied cord to connect from the telephone wall jack to your HP all-in-one, you might not be able to fax successfully. This special phone cord is different from the phone cords you might already have in your home or office. If the supplied phone cord is too short, see [The phone cord that came with my HP all-in-one is not long enough](#) for information on extending it.

- 3 Remove the white plug from the port labeled "2-EXT" on the back of your HP all-in-one.
- 4 Using another phone cord, connect one end to the port labeled "2-EXT" on the back of your HP all-in-one. Connect the other end of the phone cord to the parallel splitter on the side with the single phone port.
- 5 If your PC modem software is set to receive faxes to your computer automatically, turn off that setting.



**Caution** If you do not turn off the auto fax receive setting in your PC modem software, your HP all-in-one will not be able to receive faxes.

- 6 (Optional) Connect a phone to the other open phone port on the parallel splitter.

- 7 Now you need to decide how you want the HP all-in-one to answer calls, automatically or manually:
  - If you set up the HP all-in-one to answer calls automatically, it answers all incoming calls and receives faxes. Your HP all-in-one will not be able to distinguish between fax and voice calls in this case; if you suspect the call is a voice call, you will need to answer it before the HP all-in-one answers the call. To answer fax calls automatically, press the **Auto Answer** button until the light is on.
  - If you set up the HP all-in-one to answer faxes manually, you must be available to respond in person to incoming fax calls or your HP all-in-one cannot receive faxes.
    - To answer fax calls manually, press the **Auto Answer** button until the light is off.
- 8 Run a fax test. For information, see [Test your fax setup](#).

If you pick up the phone before the HP all-in-one and hear fax tones from a sending fax machine, you will need to answer the fax call manually. For information, see [Receive a fax manually](#).

### Set up your HP all-in-one to a computer with two phone ports

This section describes how to set up your HP all-in-one with a PC modem if your computer has two phone ports.

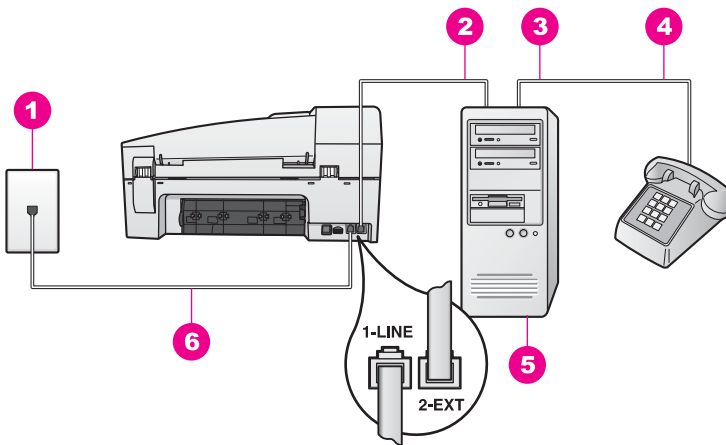

#### Back view of the HP all-in-one

|   |   |
|---|---|
| 1 | Telephone wall jack   |
| 2 | "IN" phone port on your computer  |
| 3 | "OUT" phone port on your computer   |
| 4 | Telephone   |
| 5 | Computer with modem   |
| 6 | Phone cord supplied in the box with your HP all-in-one connected to the "1-LINE" port |

## To set up your HP all-in-one to a computer with two phone ports

- 1 Remove the white plug from the port labeled "2-EXT" on the back of your HP all-in-one.
- 2 Find the phone cord that connects from the back of your computer (your PC modem) to a telephone wall jack. Disconnect the cord from the telephone wall jack and plug it into the port labeled "2-EXT" on the back of your HP all-in-one.
- 3 Connect a phone to the "OUT" port on the back of your PC modem.
- 4 Using the phone cord supplied in the box with your HP all-in-one, connect one end to your telephone wall jack, then connect the other end to the port labeled "1-LINE" on the back of your HP all-in-one.



**Caution** If you do not use the supplied cord to connect from the telephone wall jack to your HP all-in-one, you might not be able to fax successfully. This special phone cord is different from the phone cords you might already have in your home or office. If the supplied phone cord is too short, see [The phone cord that came with my HP all-in-one is not long enough for information on extending it.](#)

- 5 If your PC modem software is set to receive faxes to your computer automatically, turn off that setting.



**Caution** If you do not turn off the auto fax receive setting in your PC modem software, your HP all-in-one will not be able to receive faxes.

- 6 Now you need to decide how you want the HP all-in-one to answer calls, automatically or manually:
  - If you set up the HP all-in-one to answer calls automatically, it answers all incoming calls and receives faxes. Your HP all-in-one will not be able to distinguish between fax and voice calls in this case; if you suspect the call is a voice call, you will need to answer it before the HP all-in-one answers the call. To answer fax calls automatically, press the **Auto Answer** button until the light is on.
  - If you set up the HP all-in-one to answer faxes manually, you must be available to respond in person to incoming fax calls or your HP all-in-one cannot receive faxes.  
To answer fax calls manually, press the **Auto Answer** button until the light is off.
- 7 Run a fax test. For information, see [Test your fax setup](#).

If you pick up the phone before the HP all-in-one and hear fax tones from a sending fax machine, you will need to answer the fax call manually. For information, see [Receive a fax manually](#).

## Case I: Shared voice/fax line with answering machine

If you receive both voice calls and fax calls at the same phone number, and you also have an answering machine that answers voice calls at this phone number, set up your HP all-in-one as described in this section.

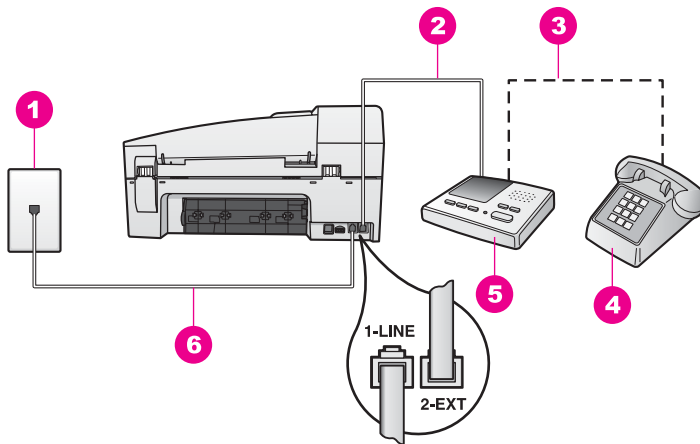

### Back view of the HP all-in-one

|   |   |
|---|---|
| 1 | Telephone wall jack   |
| 2 | "IN" port on your answering machine   |
| 3 | "OUT" port on your answering machine  |
| 4 | Telephone (optional)  |
| 5 | Answering machine   |
| 6 | Phone cord supplied in the box with your HP all-in-one connected to the "1-LINE" port |

### To set up your HP all-in-one with a shared voice/fax line with answering machine

- 1 Remove the white plug from the port labeled "2-EXT" on the back of your HP all-in-one.
- 2 Unplug your answering machine from the telephone wall jack, and connect it to the port labeled "2-EXT" on the back of your HP all-in-one.

**Note** If you do not connect your answering machine directly to your HP all-in-one, fax tones from a sending fax machine might be recorded on your answering machine, and you probably will not be able to receive faxes with your HP all-in-one.

- 3 Using the phone cord supplied in the box with your HP all-in-one, connect one end to your telephone wall jack, then connect the other end to the port labeled "1-LINE" on the back of your HP all-in-one.



**Caution** If you do not use the supplied cord to connect from the telephone wall jack to your HP all-in-one, you might not be able to fax successfully. This special phone cord is different from the phone cords you might already have in your home or office. If the supplied phone cord is too short, see [The phone cord that came with my HP all-in-one is not long enough for information on extending it.](#)

- 4 (Optional) If your answering machine does not have a built-in phone, for convenience you might want to connect a phone to the back of your answering machine at the "OUT" port.

- 5 Set up the HP all-in-one to answer incoming calls automatically. Press the **Auto Answer** button until the light is on.
- 6 Set your answering machine to answer after four or fewer rings.
- 7 Change the **Rings to Answer** setting on your HP all-in-one to six rings. For information on changing this setting, see [Set the number of rings before answering](#).
- 8 Run a fax test. For information, see [Test your fax setup](#).

When the phone rings, your answering machine will answer after the number of rings you have set, and then play your recorded greeting. The HP all-in-one monitors the call during this time, "listening" for fax tones. If incoming fax tones are detected, the HP all-in-one will emit fax reception tones and receive the fax; if there are no fax tones, the HP all-in-one stops monitoring the line and your answering machine can record a voice message.

## Case J: Shared voice/fax line with PC modem and answering machine

If you receive both voice calls and fax calls at the same phone number, and you also have a PC modem and answering machine connected on this phone line, set up your HP all-in-one as described in this section.

Since your PC modem shares the phone line with your HP all-in-one, you will not be able to use both your PC modem and your HP all-in-one simultaneously. For example, you cannot use your HP all-in-one for faxing if you are using your PC modem to send an e-mail or access the Internet.

There are two different ways to set up your HP all-in-one with your computer based on the number of phone ports on your computer. Before you begin, check your computer to see if it has one or two phone ports:

- If your computer has only one phone port, see the next section, [Set up your HP all-in-one to a computer with one phone port](#). You will need to purchase a parallel splitter (also called a coupler) in order to send and receive faxes successfully and use your PC modem. (A parallel splitter has one RJ-11 port on the front and two RJ-11 ports on the back. Do not use a 2-line phone splitter, a serial splitter, or a parallel splitter which has two RJ-11 ports on the front and a plug on the back.) You will also need three additional phone cords. You can purchase a parallel splitter and additional phone cords from an electronics store.
- If your computer has two phone ports, see [Set up your HP all-in-one to a computer with two phone ports](#).

### Set up your HP all-in-one to a computer with one phone port

This section describes how to set up your HP all-in-one with a PC modem if your computer has only one phone port.

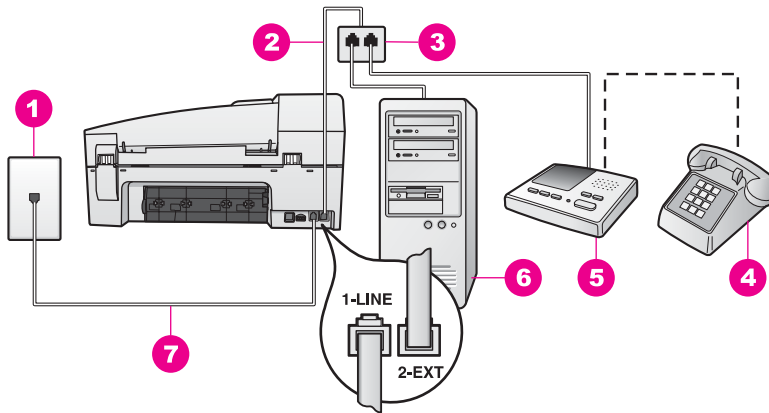

### Back view of the HP all-in-one

|   |   |
|---|---|
| 1 | Telephone wall jack   |
| 2 | Phone cord connected to the "2-EXT" port  |
| 3 | Parallel splitter   |
| 4 | Telephone (optional)  |
| 5 | Answering machine   |
| 6 | Computer with modem   |
| 7 | Phone cord supplied in the box with your HP all-in-one connected to the "1-LINE" port |

### To set up your HP all-in-one to a computer with one phone port

- 1 Find the phone cord that connects from the back of your computer (your PC modem) to a telephone wall jack. Disconnect the cord from the telephone wall jack and plug it into the parallel splitter on the side with two phone ports.
- 2 Using the phone cord supplied in the box with your HP all-in-one, connect one end to your telephone wall jack, then connect the other end to the port labeled "1-LINE" on the back of your HP all-in-one.



**Caution** If you do not use the supplied cord to connect from the telephone wall jack to your HP all-in-one, you might not be able to fax successfully. This special phone cord is different from the phone cords you might already have in your home or office. If the supplied phone cord is too short, see [The phone cord that came with my HP all-in-one is not long enough for information on extending it.](#)

- 3 Remove the white plug from the port labeled "2-EXT" on the back of your HP all-in-one.
- 4 Using another phone cord, connect one end to the port labeled "2-EXT" on the back of your HP all-in-one. Connect the other end of the phone cord to the parallel splitter on the side with the single phone port.
- 5 Unplug your answering machine from the telephone wall jack, and connect it to the parallel splitter on the side with two phone ports.

**Note** If you do not connect your answering machine in this way, fax tones from a sending fax machine might be recorded on your answering machine, and you might not be able to receive faxes with your HP all-in-one.

- 6 (Optional) If your answering machine does not have a built-in phone, for convenience you might want to connect a phone to the back of your answering machine at the "OUT" port.
- 7 If your PC modem software is set to receive faxes to your computer automatically, turn off that setting.



**Caution** If you do not turn off the auto fax receive setting in your PC modem software, your HP all-in-one will not be able to receive faxes.

- 8 Set up the HP all-in-one to answer incoming calls automatically. Press the **Auto Answer** button until the light is on.
- 9 Set your answering machine to answer after four or fewer rings.
- 10 Change the **Rings to Answer** setting on your HP all-in-one to six rings. For information on changing this setting, see [Set the number of rings before answering](#).
- 11 Run a fax test. For information, see [Test your fax setup](#).

When the phone rings, your answering machine will answer after the number of rings you have set, and then play your recorded greeting. The HP all-in-one monitors the call during this time, "listening" for fax tones. If incoming fax tones are detected, the HP all-in-one will emit fax reception tones and receive the fax; if there are no fax tones, the HP all-in-one stops monitoring the line and your answering machine can record a voice message.

### Set up your HP all-in-one to a computer with two phone ports

This section describes how to set up your HP all-in-one with a PC modem if your computer has two phone ports.



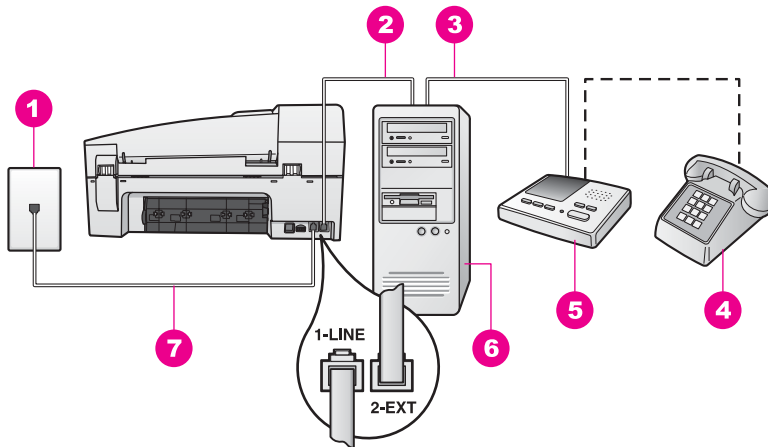

### Back view of the HP all-in-one

|   |   |
|---|---|
| 1 | Telephone wall jack   |
| 2 | "IN" phone port on your computer  |
| 3 | "OUT" phone port on your computer   |
| 4 | Telephone   |
| 5 | Answering machine   |
| 6 | Computer with modem   |
| 7 | Phone cord supplied in the box with your HP all-in-one connected to the "1-LINE" port |

### To set up your HP all-in-one to a computer with two phone ports

- 1 Remove the white plug from the port labeled "2-EXT" on the back of your HP all-in-one.
- 2 Find the phone cord that connects from the back of your computer (your PC modem) to a telephone wall jack. Disconnect the cord from the telephone wall jack and plug it into the port labeled "2-EXT" on the back of your HP all-in-one.
- 3 Unplug your answering machine from the telephone wall jack, and connect it to the "OUT" port on the back of your PC modem.  
This allows a direct connection between the HP all-in-one and your answering machine, even though the PC modem is connected first in line.

**Note** If you do not connect your answering machine in this way, fax tones from a sending fax machine might be recorded on your answering machine, and you might not be able to receive faxes with your HP all-in-one.

- 4 Using the phone cord supplied in the box with your HP all-in-one, connect one end to your telephone wall jack, then connect the other end to the port labeled "1-LINE" on the back of your HP all-in-one.



**Caution** If you do not use the supplied cord to connect from the telephone wall jack to your HP all-in-one, you might not be able to fax successfully. This special phone cord is different from the phone cords you might already have in your home or office. If the supplied phone cord is too short, see [The phone cord that came with my HP all-in-one is not long enough for information on extending it.](#)

- (Optional) If your answering machine does not have a built-in phone, for convenience you might want to connect a phone to the back of your answering machine at the "OUT" port.
- If your PC modem software is set to receive faxes to your computer automatically, turn off that setting.



**Caution** If you do not turn off the auto fax receive setting in your PC modem software, your HP all-in-one will not be able to receive faxes.

- Set up the HP all-in-one to answer incoming calls automatically. Press the **Auto Answer** button until the light is on.
- Set your answering machine to answer after four or fewer rings.
- Change the **Rings to Answer** setting on your HP all-in-one to six rings. For information on changing this setting, see [Set the number of rings before answering](#).
- Run a fax test. For information, see [Test your fax setup](#).

When the phone rings, your answering machine will answer after the number of rings you have set, and then play your recorded greeting. The HP all-in-one monitors the call during this time, "listening" for fax tones. If incoming fax tones are detected, the HP all-in-one will emit fax reception tones and receive the fax; if there are no fax tones, the HP all-in-one stops monitoring the line and your answering machine can record a voice message.

## Case K: Shared voice/fax line with PC modem and voice mail

If you receive both voice calls and fax calls at the same phone number, use a PC modem on the same phone line, and subscribe to a voice mail service through your telephone company, set up your HP all-in-one as described in this section.

**Note** You cannot receive faxes automatically if you have a voice mail service at the same phone number you use for fax calls. You must receive faxes manually; this means you must be available to respond in person to incoming fax calls. If you want to receive faxes automatically instead, contact your telephone company to subscribe to a distinctive ring service, or to obtain a separate phone line for faxing.

Since your PC modem shares the phone line with your HP all-in-one, you will not be able to use both your PC modem and your HP all-in-one simultaneously. For example, you cannot use your HP all-in-one for faxing if you are using your PC modem to send an e-mail or access the Internet.

There are two different ways to set up your HP all-in-one with your computer based on the number of phone ports on your computer. Before you begin, check your computer to see if it has one or two phone ports:

- If your computer has only one phone port, see the next section, [Set up your HP all-in-one to a computer with one phone port](#). You will need to purchase a parallel splitter (also called a coupler) in order to send and receive faxes successfully and use your PC modem. (A parallel splitter has one RJ-11 port on the front and two RJ-11 ports on the back. Do not use a 2-line phone splitter, a serial splitter, or a parallel splitter which has two RJ-11 ports on the front and a plug on

the back.) You will also need three additional phone cords. You can purchase a parallel splitter and additional phone cords from an electronics store.

- If your computer has two phone ports, see [Set up your HP all-in-one to a computer with two phone ports](#).

## Set up your HP all-in-one to a computer with one phone port

This section describes how to set up your HP all-in-one with a PC modem if your computer has only one phone port.

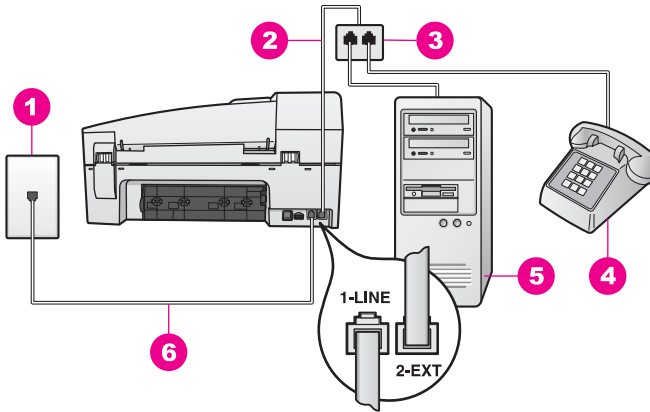

### Back view of the HP all-in-one

|   |   |
|---|---|
| 1 | Telephone wall jack   |
| 2 | Phone cord connected to the "2-EXT" port  |
| 3 | Parallel splitter   |
| 4 | Telephone   |
| 5 | Computer with modem   |
| 6 | Phone cord supplied in the box with your HP all-in-one connected to the "1-LINE" port |

### To set up your HP all-in-one to a computer with one phone port

- 1 Find the phone cord that connects from the back of your computer (your PC modem) to a telephone wall jack. Disconnect the cord from the telephone wall jack and plug it into the parallel splitter on the side with two phone ports.
- 2 Using another phone cord, connect one end to the port labeled "2-EXT" on the back of your HP all-in-one. Connect the other end of the phone cord to the parallel splitter on the side with the single phone port.
- 3 Using the phone cord supplied in the box with your HP all-in-one, connect one end to your telephone wall jack, then connect the other end to the port labeled "1-LINE" on the back of your HP all-in-one.



**Caution** If you do not use the supplied cord to connect from the telephone wall jack to your HP all-in-one, you might not be able to fax successfully.

This special phone cord is different from the phone cords you might already have in your home or office. If the supplied phone cord is too short, see [The phone cord that came with my HP all-in-one is not long enough for information on extending it.](#)

- 4 Remove the white plug from the port labeled "2-EXT" on the back of your HP all-in-one.
- 5 If your PC modem software is set to receive faxes to your computer automatically, turn off that setting.



**Caution** If you do not turn off the auto fax receive setting in your PC modem software, your HP all-in-one will not be able to receive faxes.

- 6 (Optional) Connect a phone to the other open phone port on the parallel splitter.
- 7 Set up the HP all-in-one to answer incoming calls manually. Press the **Auto Answer** button until the light is off.
- 8 Run a fax test. For information, see [Test your fax setup](#).

You must be available to respond in person to incoming fax calls, or your HP all-in-one cannot receive faxes. For information on receiving faxes manually, see [Receive a fax manually](#).

### Set up your HP all-in-one to a computer with two phone ports

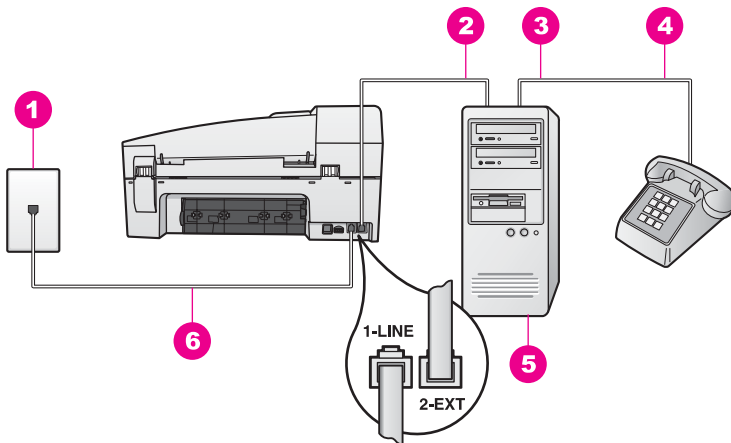

#### Back view of the HP all-in-one

|   |   |
|---|---|
| 1 | Telephone wall jack   |
| 2 | "IN" phone port on your computer  |
| 3 | "OUT" phone port on your computer   |
| 4 | Telephone   |
| 5 | Computer with modem   |
| 6 | Phone cord supplied in the box with your HP all-in-one connected to the "1-LINE" port |

#### To set up your HP all-in-one to a computer with two phone ports

- 1 Remove the white plug from the port labeled "2-EXT" on the back of your HP all-in-one.
- 2 Find the phone cord that connects from the back of your computer (your PC modem) to a telephone wall jack. Disconnect the cord from the telephone wall jack and plug it into the port labeled "2-EXT" on the back of your HP all-in-one.
- 3 Connect a phone to the "OUT" port on the back of your PC modem.

- Using the phone cord supplied in the box with your HP all-in-one, connect one end to your telephone wall jack, then connect the other end to the port labeled "1-LINE" on the back of your HP all-in-one.



**Caution** If you do not use the supplied cord to connect from the telephone wall jack to your HP all-in-one, you might not be able to fax successfully. This special phone cord is different from the phone cords you might already have in your home or office. If the supplied phone cord is too short, see [The phone cord that came with my HP all-in-one is not long enough](#) for information on extending it.

- If your PC modem software is set to receive faxes to your computer automatically, turn off that setting.



**Caution** If you do not turn off the auto fax receive setting in your modem software, your HP all-in-one will not be able to receive faxes.

- Set up the HP all-in-one to answer incoming calls manually. Press the **Auto Answer** button until the light is off.
- Run a fax test. For information, see the next section, [Test your fax setup](#).

You must be available to respond in person to incoming fax calls, or your HP all-in-one cannot receive faxes. For information on receiving faxes manually, see [Receive a fax manually](#).

## Test your fax setup

You can test your fax setup to check the status of your HP all-in-one and to make sure it is set up properly for faxing. Perform this test after you have completed setting up your HP all-in-one for faxing. The test does the following:

- Checks the fax hardware
- Verifies that the phone cord is plugged into the correct port
- Checks for a dial tone
- Checks for an active phone line
- Checks the status of your phone line connection

The HP all-in-one prints a report with the results of the test. If the test fails, review the report for information on how to fix the problem and rerun the test.

### To test your fax setup from the control panel

- Set up your HP all-in-one for faxing according to the setup instructions in this chapter.
- Make sure you have inserted the print cartridges and loaded paper before starting the test.  
For more information, see [Replace the print cartridges](#) and [Load full-size paper](#).
- Press **Setup**.
- Press **6**, then press **5**.  
This selects the **Tools** menu and then selects **Run Fax Test**.  
The HP all-in-one displays the status of the test on the control panel display and prints a report.

- 5 Review the report.
  - If the test passes and you are still having problems faxing, check the fax settings listed in the report to verify the settings are correct. A blank or incorrect fax setting can cause problems faxing.
  - If the test fails, review the report for more information on how to fix any problems found.
- 6 After you pick up the fax report from your HP all-in-one, press **OK**.

If necessary, resolve any problems found and rerun the test.  
For more information on resolving any problems found during the test, see [The fax test failed](#).



# 11 Use the fax features

You can use your HP all-in-one to send and receive faxes, including color faxes. You can set up speed dials to send faxes quickly and easily to frequently used numbers. From the control panel, you can also set a number of fax options, such as resolution.

You should explore the **HP Director** that came with your **HP Image Zone** software to take full advantage of all of its features. Using the **HP Director**, you can send a fax from your computer, include a computer-generated cover page, and quickly set up speed dials. For more information, see the onscreen **HP Image Zone Help**.

For information on accessing the **HP Director**, see [Use the HP Image Zone to do more with your HP all-in-one](#).

## Set up the HP all-in-one to receive faxes

Your HP all-in-one can be set up to receive faxes automatically or manually, depending on your home or office setup. If you set up the HP all-in-one to answer faxes automatically, it answers all incoming calls and receives faxes. If you set up the HP all-in-one to answer faxes manually, you must be available to respond in person to the incoming fax call, or your HP all-in-one cannot receive faxes. For more information on receiving faxes manually, see [Receive a fax manually](#).

In certain situations you might want to receive faxes manually. For example, if you share a phone line between your HP all-in-one and phone and you do not have distinctive ringing or an answering machine, you will need to set up the HP all-in-one to answer fax calls manually. If you subscribe to a voice mail service, you will also need to answer fax calls manually. This is because the HP all-in-one will not be able to distinguish between fax calls and phone calls.

For more information on setting up your office equipment with the HP all-in-one, see [Fax setup](#).

### Choose the recommended answer mode for your setup

Refer to the table below to determine the recommended answer mode for your HP all-in-one based on your home or office setup. From the first column in the table, choose the type of equipment and services applicable to your office setup. Then, look up the recommended answer mode in the second column. The third column describes how the HP all-in-one will answer incoming calls.

After you have determined the recommended answer mode setting for your home or office setup, see [Set the answer mode](#) for more information.

| Equipment/services sharing your fax phone line                                     | Recommended answer mode                            | Description  |
|--|--|--|
| None.<br>(You have a separate fax phone line on which you receive only fax calls.) | Automatic<br>(The <b>Auto Answer</b> light is on.) | The HP all-in-one automatically answers all incoming calls using the <b>Rings to Answer</b> setting. For more information on setting the |



| Equipment/services sharing your fax phone line  | Recommended answer mode                                    | Description  |
|---|--|--|
|   |  | number of rings, see <a href="#">Set the number of rings before answering</a> .  |
| <p>A shared voice and fax phone line and no answering machine.</p> <p>(You have a shared phone line in which you receive both voice and fax calls.)</p> | <p>Manual<br/>(The <b>Auto Answer</b> light is off.)</p>   | <p>The HP all-in-one will not automatically answer calls. You must receive all faxes manually by pressing <b>Start Fax Black</b> or <b>Start Fax Color</b>. For information on receiving faxes manually, see <a href="#">Receive a fax manually</a>.</p> <p>You might use this setting if the majority of calls on this phone line are voice calls and you rarely receive faxes.</p>   |
| <p>Voice mail service provided by your telephone company.</p>   | <p>Manual<br/>(The <b>Auto Answer</b> light is off.)</p>   | <p>The HP all-in-one will not automatically answer calls. You must receive all faxes manually by pressing <b>Start Fax Black</b> or <b>Start Fax Color</b>. For information on receiving faxes manually, see <a href="#">Receive a fax manually</a>.</p>   |
| <p>An answering machine and a shared voice and fax phone line.</p>  | <p>Automatic<br/>(The <b>Auto Answer</b> light is on.)</p> | <p>The answering machine will answer the call and the HP all-in-one will monitor the line. If the HP all-in-one detects fax tones, the HP all-in-one will receive the fax.</p> <p><b>Note</b> This is the recommended setting if you have an answering machine. Make sure the answering machine is set up properly with the HP all-in-one. For information, see <a href="#">Fax setup</a>.</p> <p>Also, set the number of rings to answer for the HP all-in-one to a number greater than the number of rings to answer for the answering machine. The answering machine must answer the call before your HP all-in-one. For more information on setting the number of rings to answer, see <a href="#">Set the number of rings before answering</a>.</p> |
| <p>Distinctive ringing service.</p>   | <p>Automatic<br/>(The <b>Auto Answer</b> light is on.)</p> | <p>The HP all-in-one automatically answers all incoming calls.</p> <p>Make sure the ring pattern the phone company set for your fax phone line matches the <b>Answer Ring Pattern</b> set for the HP all-in-one. For more information, see <a href="#">Change the answer ring pattern (distinctive ringing)</a>.</p>   |

## Set the answer mode

The answer mode determines whether your HP all-in-one answers incoming calls or not. If you set up the HP all-in-one to answer faxes automatically (the **Auto Answer** light is on), it answers all incoming calls and receives faxes. If you set up the HP all-in-one to answer faxes manually (the **Auto Answer** light is off), you must be available to respond in person to the incoming fax call, or your HP all-in-one will not receive faxes. For more information on receiving faxes manually, see [Receive a fax manually](#).

If you do not know which answer mode to use, see [Choose the recommended answer mode for your setup](#).

→ Press the **Auto Answer** button to set the answer mode.

When the **Auto Answer** light is on, your HP all-in-one automatically answers calls. When the light is off, your HP all-in-one does not answer calls.

## Send a fax

You can send a fax in a variety of ways. Using the control panel, you can send a black-and-white or color fax from your HP all-in-one. You can also send a fax manually from an attached phone. This allows you to speak with the recipient before sending the fax.

If you frequently send faxes to the same numbers, you can set up speed dials to send faxes by using the **Speed Dial** button or a one-touch speed dial button. Review this section for more information on all the ways you can send faxes.

### Send a basic fax

You can send a basic single- or multiple-page fax by using the control panel.

**Note** If you need printed confirmation that your faxes were successfully sent, enable fax confirmation **before** sending any faxes. For information, see [Enable fax confirmation](#).

**Tip** You can also send a fax using monitor dialing. This allows you to control the pace of your dialing. This feature is useful when you want to use a calling card to charge the call and you need to respond to tone prompts while dialing. For more information, see [Send a fax using monitor dialing](#).

- 1 Load your originals face up in the document feeder tray with the top of the page on the left. If you are sending a single-page fax, you can also load it on the glass.

**Note** If you are sending a multiple-page fax, you must load the originals in the automatic document feeder.

- 2 Enter the fax number by using the keypad.

**Tip** To enter a pause in the fax number, press **Redial/Pause**.

- 3 Press **Start Fax Black**.

- 4 If your original is loaded on the glass, press **1**.

**Tip** You can also send a fax in color, such as a photo, from your HP all-in-one. Just press **Start Fax Color** instead of **Start Fax Black**.

Did you know that you can send a fax from your computer by using the **HP Director** that came with your **HP Image Zone** software? You can also create and attach a computer-generated cover page to send with your fax. It's easy. For more information, see the onscreen **HP Image Zone Help** that came with your **HP Image Zone** software.

## Enable fax confirmation

If you need printed confirmation that your faxes were successfully sent, follow these instructions to enable fax confirmation **before** sending any faxes.

The default fax confirmation setting is **Every Error**. This means that your HP all-in-one prints a report only if there is a problem with sending or receiving a fax. A confirmation message indicating whether a fax was successfully sent appears briefly on the control panel display after each transaction. For more information on printing reports, see [Print reports](#).

- 1 Press **Setup**.
- 2 Press **2**, and then press **1**.  
This selects **Print Report** and then selects **Fax Report Setup**.
- 3 Press **▶** until **Send Only** appears, and then press **OK**.

Every time you send a fax, the HP all-in-one will print a confirmation report informing you whether the fax was sent successfully or not.

**Note** If you select **Send Only**, you will not receive printed reports if there are errors while the HP all-in-one is receiving faxes. Print the **Fax Log** to view any receive errors. For more information on printing the **Fax Log**, see [Generate reports manually](#).

## Send a fax manually from a phone

You can make a phone call and talk with the recipient before you send your fax. This method of sending a fax is called manually sending a fax. Sending a fax manually is useful if you want to make sure the recipient is available to receive the fax before you send it.

The phone must be connected to the "2-EXT" port on the back of the HP all-in-one. For information on setting up your HP all-in-one with your phone, see [Fax setup](#).

- 1 Load your originals face up in the document feeder tray with the top of the page on the left.
- 2 Dial the number by using the keypad on the phone that is connected to your HP all-in-one.

**Note** You must use the keypad on the phone to dial the number. Do not use the keypad on the control panel of the HP all-in-one.

- 3 Do one of the following:
  - If after dialing the number you hear fax tones, press **Start Fax Black** or **Start Fax Color** within three seconds to send the fax.
  - If the recipient answers the telephone, you can engage in a conversation before sending your fax. Once you are ready to send your fax, press the **Start Fax Black** or **Start Fax Color** button on the control panel.

The phone line will go silent while the fax is transmitting. At this point, you can hang up the telephone. If you want to continue speaking with the recipient, remain on the line until the fax transmission is complete.

## Send a fax using redial

You can use redial to send a fax to the last fax number dialed from the control panel.

- 1 Load your originals face up in the document feeder tray with the top of the page on the left.
- 2 Press **Redial/Pause**.  
The last number dialed appears in the control panel display.
- 3 Press **Start Fax Black** or **Start Fax Color**.

## Send a fax using speed dials

You can quickly send a fax by pressing **Speed Dial** or a one-touch speed dial button on the control panel. The one-touch speed dial buttons correspond to the first five speed-dial entries.

Speed-dial entries will not appear until you have set them up. For more information, see [Set up speed dialing](#).

- 1 Load your originals face up in the document feeder tray with the top of the page on the left.
- 2 Do one of the following:
  - Press **Speed Dial** until the appropriate speed-dial entry appears. You can also scroll through the speed-dial entries by pressing ◀ or ▶.
  - Press **Speed Dial** and then enter the speed-dial code by using the keypad on the control panel.
  - Press a one-touch speed dial button.
- 3 Press **Start Fax Black** or **Start Fax Color**.

## Schedule a fax

You can schedule a black-and-white fax to be sent later the same day (when phone lines are not as busy or phone rates are lower, for example). When scheduling a fax, the originals must be loaded in the document feeder tray and not on the glass. The HP all-in-one automatically sends your fax when the specified time is reached.

You can only schedule one fax to be sent at a time. You can continue to send faxes normally, however, while a fax is scheduled.

- 1 Load your originals face up in the document feeder tray with the top of the page on the left.

**Note** Load your originals in the document feeder tray, and not on the glass. This feature is not supported if you load your originals on the glass.

- 2 In the Fax area, press **Menu** until **How to Fax** appears.
- 3 Press ▶ until **Send Fax Later** appears, and then press **OK**.
- 4 Enter the send time by using the numeric keypad, and then press **OK**.
- 5 Enter the fax number by using the keypad, press a one-touch speed dial button, or press **Speed Dial** until the appropriate speed-dial entry appears.
- 6 Press **Start Fax Black**.

The HP all-in-one sends the fax at the scheduled time and the scheduled time appears on the control panel display.

## Cancel a scheduled fax

You can cancel a scheduled fax or one that is currently in progress. After you schedule a fax, the scheduled time appears on the control panel display.

- After the scheduled time appears on the control panel display, press **Cancel**, and then press **1**.

The scheduled fax is cancelled.

## Send a fax from memory

You can scan a black-and-white fax into memory and then send the fax from memory. This feature is useful if the fax number you are trying to reach is busy or temporarily unavailable. The HP all-in-one scans the originals into memory and sends them once it is able to connect to the receiving fax machine. After the HP all-in-one scans the pages into memory, you can immediately remove the originals from the document feeder tray.

- 1 Load your originals face up in the document feeder tray with the top of the page on the left.

**Note** Load your originals in the document feeder tray, and not on the glass. This feature is not supported if you load your originals on the glass.

- 2 In the Fax area, press **Menu** until **How to Fax** appears.
- 3 Press **▶** until **Scan & Fax** appears, and then press **OK**.
- 4 Enter the fax number by using the keypad, press a one-touch speed dial button, or press **Speed Dial** until the appropriate speed-dial entry appears.
- 5 Press **Start Fax Black**.

**Note** If you press **Start Fax Color**, the fax will be sent in black and white and a message appears on the control panel display.

The HP all-in-one scans the originals into memory and sends the fax when the receiving fax machine is available. If you want to send all faxes with this setting, change it to the default. For more information, see [Set new default settings](#).

## Send a fax using monitor dialing

Monitor dialing allows you to dial a number from the control panel as you would dial a regular telephone. This feature is useful when you want to use a calling card to charge the call and you need to respond to tone prompts while dialing. It also allows you to dial the number at your own pace, if necessary.

**Note** Make sure the volume is turned on, or you will not hear a dial tone. For information, see [Adjust the volume](#).

- 1 Load your originals face up in the document feeder tray with the top of the page on the left. If you are sending a single-page fax, you can also load it on the glass.
- 2 Press **Start Fax Black** or **Start Fax Color**.
- 3 If your original is loaded on the glass, press **1**.
- 4 After you hear the dial tone, enter the number by using the keypad on the control panel.
- 5 Follow any prompts that might occur.

Your fax is sent when the receiving fax machine answers.

## Receive a fax

Your HP all-in-one can receive faxes automatically or manually, depending on the answer mode that you set. If the light next to the **Auto Answer** button is on, your HP all-in-one automatically answers incoming calls and receive faxes. If the light is off, you need to receive faxes manually. For more information on the answer mode, see [Set up the HP all-in-one to receive faxes](#).

**Note** If you installed a photo print cartridge for printing photos, you might want to replace it with the black print cartridge when receiving faxes. See [Work with print cartridges](#).

### Set the number of rings before answering

You can specify how many rings should occur before your HP all-in-one automatically answers the incoming call.

**Note** This setting only applies if your HP all-in-one is set to receive faxes automatically.

The **Rings to Answer** setting is important if you have an answering machine on the same phone line as your HP all-in-one. The answering machine must answer the call before your HP all-in-one. The number of rings to answer for the HP all-in-one should be greater than the number of rings to answer for the answering machine.

For example, set your answering machine to answer in 4 rings and your HP all-in-one to answer in the maximum number of rings supported by your device. (The maximum number of rings varies by country/region.) In this setup, the answering machine will answer the call and the HP all-in-one will monitor the line. If the HP all-in-one detects fax tones, the HP all-in-one will receive the fax. If the call is a voice call, the answering machine will record the incoming message.

#### To set the number of rings before answering from the control panel

- 1 Press **Setup**.
- 2 Press **4**, and then press **3**.  
This selects **Basic Fax Setup** and then selects **Rings to Answer**.
- 3 Enter the appropriate number of rings by using the keypad.
- 4 Press **OK** to accept the setting.

### Receive a fax manually

If you set up your HP all-in-one to receive faxes manually (the **Auto Answer** light is off) or you answer the phone and hear fax tones, use the instructions in this section to receive faxes.

You can receive faxes manually from a phone that is:

- Directly connected to the HP all-in-one (on the "2-EXT" port)
  - On the same phone line, but is not connected to the HP all-in-one
- 1 Make sure the HP all-in-one is turned on and you have paper loaded in the input tray.
  - 2 Remove any originals from the document feeder tray.
  - 3 Set the **Rings to Answer** setting to a high number to allow you to answer the incoming call before the HP all-in-one answers. Or, set your HP all-in-one to answer faxes manually.

For information on setting the number of rings to answer, see [Set the number of rings before answering](#). For information on setting the HP all-in-one to answer faxes manually, see [Set the answer mode](#).

- 4 Do one of the following:
  - If your phone is on the same phone line (but not plugged into the back of the HP all-in-one) and you hear fax tones from a sending fax machine, wait 5 - 10 seconds before pressing **1 2 3** on your phone. If the HP all-in-one does not begin receiving the fax, wait several more seconds and press **1 2 3** again.

**Note** When the HP all-in-one receives an incoming call, it displays **Ring** on the control panel display. If you pick up the phone, **Phone Off Hook** appears after a few seconds. You must wait until **Phone Off Hook** appears before pressing **1 2 3** on your phone or you will not be able to receive the fax.

- If your phone is plugged directly into the back of the HP all-in-one and you hear fax tones from a sending fax machine, press the **Start Fax Black** or **Start Fax Color** button on the control panel. Then, press **2** to receive the fax.
- If you are currently on the phone with the sender using a phone connected to the HP all-in-one, instruct them to press Start on their fax machine first. After you hear fax tones from the sending fax machine, press the **Start Fax Black** or **Start Fax Color** button on the control panel. Then, press **2** to receive the fax.

**Note** If you press **Start Fax Color** but the sender sent the fax in black and white, the HP all-in-one prints the fax in black and white.

### Poll to receive a fax

Polling allows your HP all-in-one to ask another fax machine to send a fax that it has in its queue. When you use the **Poll to Receive** feature, the HP all-in-one calls the designated fax machine and requests the fax from it. The designated fax machine must be set for polling and have a fax ready to send.

**Note** The HP all-in-one does not support polling pass codes. This is a security feature that requires the receiving fax machine (your HP all-in-one) to provide a pass code to the device it is polling in order to receive the fax. Make sure the device you are polling does not have a pass code set up (or changed the default pass code) or the HP all-in-one will not be able to receive the fax.

- 1 In the Fax area, press **Menu** until **How to Fax** appears.
- 2 Press **▶** until **Poll to Receive** appears, and then press **OK**.
- 3 Enter the fax number of the other fax machine.
- 4 Press **Start Fax Black** or **Start Fax Color**.

**Note** If you press **Start Fax Color** but the sender sent the fax in black and white, the HP all-in-one prints the fax in black and white.

### Set the date and time

You can set the date and time from the control panel. When a fax is transmitted, the current date and time are printed along with the fax header. The date and time format is based on the language and country/region setting.

**Note** If your HP all-in-one loses power, you will need to reset the date and time.

- 1 Press **Setup**.
- 2 Press **4**, and then press **1**.  
This selects **Basic Fax Setup** and then selects **Date and Time**.
- 3 Enter the month, day, and year by pressing the appropriate numbers on the keypad. Depending on your country/region setting, you might enter the date in a different order.  
The underline cursor is presented initially beneath the first digit; it automatically advances to the next digit when you press a button. The time prompt automatically appears after you enter the last digit of the date.
- 4 Enter the hours and minutes.
- 5 If your time is displayed in the 12-hour format, press **1** for AM, or **2** for PM.  
The new date and time settings appear on the control panel display.

## Set the fax header

The fax header prints your name and fax number on the top of every fax you send. We recommend that you set up the fax header by using the **Fax Setup Wizard** (Windows users) or the **Setup Assistant** (Macintosh users) during the **HP Image Zone** software installation.

You can also set up or change the fax header from the control panel.

The fax header information is required by law in many countries/regions.

- 1 Press **Setup**.
- 2 Press **4**, and then press **2**.  
This selects **Basic Fax Setup** and then selects **Fax Header**.
- 3 Enter your personal or company name. You can enter up to 25 characters.  
For information on entering text from the control panel, see [Enter text and symbols](#).
- 4 Press **OK**.
- 5 Enter your fax number by using the numeric keypad. You can enter up to 19 digits.
- 6 Press **OK**.

You might find it easier to enter fax header information by using the **HP Director** that came with your **HP Image Zone** software. In addition to entering fax header information, you can also enter cover page information that will be used when you send a fax from your computer and attach a cover page. For more information, see the onscreen **HP Image Zone Help** that came with your **HP Image Zone** software.

## Enter text and symbols

You can enter text and symbols from the control panel by using the keypad on the control panel when you set up speed-dial entries and the fax header information.

You can also enter symbols from the keypad when you dial a fax or phone number. When the HP all-in-one dials the number, it will interpret the symbol and respond accordingly. For example, if you enter a dash in the fax number, the HP all-in-one will pause before dialing the remainder of the number. A pause is useful if you need to access an outside line before dialing the fax number.



## Enter text using the keypad on the control panel

You can enter text or symbols by using the keypad on the control panel.

- Press the keypad numbers that correspond to the letters of a name. For example, the letters a, b, and c correspond to the number 2, as shown on the button below.



- Press a button multiple times to see the available characters.

**Note** Depending on your language and country/region setting, additional characters might be available.

- After the correct letter appears, wait for the cursor to advance automatically to the right, or press ►. Press the number that corresponds to the next letter in the name. Press the button multiple times until the correct letter appears. The first letter of a word is automatically set to uppercase.
- To insert a space, press **Space (#)**.
- To enter a pause, press **Redial/Pause**. A dash appears in the number sequence.
- To enter a symbol, such as @, press the **Symbols (\*)** button repeatedly to scroll through the list of available symbols: asterisk (\*), dash (-), ampersand (&), period (.), slash (/), parentheses ( ), apostrophe ('), equals (=), number sign (#), at (@), underscore (\_), plus (+), exclamation (!), semi colon (;), question (?), comma (,), colon (:), percent (%), and approximation (~).
- If you make a mistake, press ◀ to clear it, and then make the correct entry.
- After you are done entering text, press **OK** to store your entry.

## Print reports

You can set up your HP all-in-one to print error reports and confirmation reports automatically for each fax you send and receive. You can also manually print system reports as you need them; these reports provide useful system information about your HP all-in-one.

By default, your HP all-in-one is set to print a report only if there is a problem with sending or receiving a fax. A confirmation message that indicates whether a fax was successfully sent appears briefly on the control panel display after each transaction.

### Generate reports automatically

You can configure your HP all-in-one so that it automatically prints error and confirmation reports.

**Note** If you need printed confirmation each time a fax is sent, follow these instructions before sending any faxes and select **Send Only**.

- 1 Press **Setup**.
- 2 Press **2**, and then press **1**.  
This selects **Print Report** and then selects **Fax Report Setup**.
- 3 Press ► to scroll through the following report types:
  - **Every Error**: prints whenever there is any kind of fax error (default).
  - **Send Error**: prints whenever there is a transmission error.

- **Receive Error:** prints whenever there is a receiving error.
  - **Every Fax:** confirms every time a fax is sent or received.
  - **Send Only:** prints every time a fax is sent indicating whether the fax was successfully sent or not.
  - **Off:** does not print any error or confirmation reports.
- 4 Press **OK** to select the report.

## Generate reports manually

You can manually generate reports about your HP all-in-one, such as the status of the last fax you sent, a list of programmed speed-dial entries, or a self-test report for diagnostic purposes.

- 1 Press **Setup**, and then press **2**.  
This selects **Print Report**.
- 2 Press **▶** to scroll through the following report types:
  - **1: Fax Report Setup:** prints the automatic fax reports as described in [Generate reports automatically](#).
  - **2: Last Transaction:** prints details of the last fax transaction.
  - **3: Fax Log:** prints a log of approximately the last 30 fax transactions.
  - **4: Speed Dial List:** prints a list of programmed speed-dial entries.
  - **5: Self-Test Report:** prints a report to assist you in diagnosing print and alignment problems. For more information, see [Print a self-test report](#).
- 3 Press **OK** to print the report.

## Set up speed dialing

You can assign speed-dial entries to fax numbers you use often. Use the one-touch speed dial buttons on the control panel to send faxes quickly. You can also press **Speed Dial** to scroll through and select from the list of speed-dial entries.

The first five speed-dial entries are automatically saved to the one-touch speed dial buttons on the control panel.

For information on sending a fax using speed dials, see [Send a fax using speed dials](#).

You can quickly and easily set up speed-dial entries from your computer by using the **HP Director** that came with your **HP Image Zone** software. For more information, see the onscreen **HP Image Zone Help** that came with your **HP Image Zone** software.

## Create speed-dial entries

You can create speed-dial entries for fax numbers that you use frequently.

- 1 Press **Setup**.
- 2 Press **3**, and then press **1**.  
This selects **Speed Dial Setup** and then selects **Individual Speed Dial**.  
The first unassigned speed-dial entry appears on the control panel display.
- 3 Press **OK** to select the displayed speed-dial entry. You can also press **◀** or **▶** to select a another empty entry, and then press **OK**.
- 4 Enter the fax number to assign to that entry, and then press **OK**. You can enter up to 49 digits.

**Tip** To enter a pause in the fax number, press **Redial/Pause**.

- 5 Enter the name, and then press **OK**. You can enter up to 13 characters. For more information on entering text, see [Enter text and symbols](#).
- 6 Press **1** if you want to set up another number, or press **2** if you are finished creating speed-dial entries.

### Create group speed-dial entries

You can create a group speed-dial entry that contains up to 48 individual speed-dial entries. This allows you to send black-and-white faxes to specific groups of people by using one speed-dial entry.

**Note** You can only send black-and-white faxes when sending a fax to groups. **Very Fine** resolution is also not supported when using this feature.

You can only assign previously entered individual speed-dial numbers to a group. Additionally, only individual speed-dial entries can be added; you can't assign one group to another group.

- 1 Press **Setup**.
- 2 Press **3**, and then press **2**.  
This selects **Speed Dial Setup** and then selects **Group Speed Dial**.  
The first unassigned speed-dial entry appears on the control panel display.
- 3 Press **OK** to select the displayed speed-dial entry. You can also press **◀** or **▶** to select another empty entry, and then press **OK**.
- 4 Press **◀** or **▶** to select an individual speed-dial entry to add to the group speed dial.
- 5 Press **OK**.
- 6 Press **1** to add another individual speed-dial entry, or press **2** if you are finished.
- 7 Enter the group speed-dial name, and then press **OK**.  
For more information on entering text, see [Enter text and symbols](#).
- 8 Press **1** to add another group, or press **2** if you are finished.

### Update speed-dial entries

You can change the phone number or name of an individual speed-dial entry.

**Note** If the individual speed-dial entry is also a part of a speed-dial group, the speed-dial group will reflect any updates made to the individual speed-dial entry.

- 1 Press **Setup**.
- 2 Press **3**, and then press **1**.  
This selects **Speed Dial Setup** and then selects **Individual Speed Dial**.
- 3 Press **◀** or **▶** to scroll through the speed-dial entries, and then press **OK** to select the appropriate entry.
- 4 When the current fax number appears, press **◀** to erase it.
- 5 Enter the new fax number.
- 6 Press **OK** to save the new number.
- 7 Enter the new name.  
For more information on using entering text, see [Enter text and symbols](#).
- 8 Press **OK**.
- 9 Press **1** to update another speed-dial entry, or press **2** when you are finished.

## Delete speed-dial entries

You can delete an individual or group speed-dial entry. If you delete an individual speed-dial entry that is included in a group speed dial, it will be deleted from the group as well.

- 1 Press **Setup**.
- 2 Press **3**, and then press **3** again.  
This selects **Speed Dial Setup** and then selects **Delete Speed Dial**.
- 3 Press **◀** or **▶** until the speed-dial entry that you want to delete appears, and then press **OK** to delete it. You can also enter the speed-dial code by using the keypad on the control panel.

## Change the fax resolution and lighter/darker settings

You can change the **Fax Resolution** and **Lighter/Darker** settings for documents that you are faxing.

### Change the fax resolution

The **Fax Resolution** setting affects the transmission speed and quality of faxed black-and-white documents. The HP all-in-one sends faxes at the highest resolution supported by the receiving fax machine. You can only change the resolution for faxes that you are sending in black and white. All color faxes will be sent using **Fine** resolution. The following resolution settings are available:

- **Fine**: provides high-quality text suitable for faxing most documents. This is the default setting.
- **Very Fine**: provides the best quality fax when you are faxing documents with very fine detail. If you choose **Very Fine**, be aware that the faxing process takes longer to complete and you can only send black-and-white faxes using this resolution. If you send a color fax, it will be sent using **Fine** resolution instead.
- **Photo**: provides the best quality fax when sending photographs. If you choose **Photo**, be aware that the faxing process takes longer to complete. When faxing photographs, we recommend that you choose **Photo**.
- **Standard**: provides the fastest possible fax transmission with the lowest quality.

This setting returns to the default setting after the job has been completed, unless you set your changes as the default. For information, see [Set new default settings](#).

### To change the resolution from the control panel

- 1 Load your originals face up in the document feeder tray with the top of the page on the left.
- 2 Enter the fax number by using the keypad, press a one-touch speed dial button, or press **Speed Dial** until the appropriate speed-dial entry appears.
- 3 In the Fax area, press **Menu** until **Fax Resolution** appears.
- 4 Press **▶** to select a resolution setting.
- 5 Press **Start Fax Black**.

**Note** If you press **Start Fax Color**, the fax will be sent using the **Fine** setting.

Your fax is sent with the **Fax Resolution** setting you selected. If you want to send all faxes with this setting, change it to the default. For more information, see [Set new default settings](#).

## Change the lighter/darker setting

You can change the contrast of a fax to be darker or lighter than the original. This feature is useful if you are faxing a document that is faded, washed out, or handwritten. You can darken the original by adjusting the contrast.

This setting returns to the default setting after the job has been completed, unless you set your changes as the default. For information, see [Set new default settings](#).

- 1 Load your originals face up in the document feeder tray with the top of the page on the left.
- 2 Enter the fax number by using the keypad, press a one-touch speed dial button, or press **Speed Dial** until the appropriate speed-dial entry appears.
- 3 In the Fax area, press **Menu** until **Lighter/Darker** appears.
- 4 Press ◀ to lighten the fax or press ▶ to darken it.  
The indicator moves to the left or right as you press an arrow.
- 5 Press **Start Fax Black** or **Start Fax Color**.

Your fax is sent with the **Lighter/Darker** setting you selected. If you want to send all faxes with this setting, change it to the default. For more information, see [Set new default settings](#).

## Set new default settings

You can change the default value for the **Fax Resolution**, **Lighter/Darker**, and **How to Fax** settings through the control panel.

- 1 Make your changes to the **Fax Resolution**, **Lighter/Darker**, or **How to Fax** settings.
- 2 Press **Menu** until **Set New Defaults** appears.
- 3 Press ▶ until **Yes** appears.

## Set fax options

There are numerous fax options that you can set, such as controlling whether the HP all-in-one redials a busy number automatically. When you make changes to the following options, the new setting becomes the default. Review this section for information on changing fax options.

### Set the paper size for received faxes

You can select the paper size for received faxes. The paper size you select should match what is loaded in your input tray. Faxes can be printed on letter, A4, or legal paper only.

**Note** If an incorrect paper size is loaded in the input tray when a fax is received, the fax does not print and an error message appears on the control panel display. Load letter, A4, or legal paper, and then press **OK** to print the fax.

- 1 Press **Setup**.
- 2 Press **4**, and then press **4** again.  
This selects **Basic Fax Setup** and then selects **Fax Paper Size**.
- 3 Press ▶ to select an option, and then press **OK**.

## Set tone or pulse dialing

You can set the dial mode for your HP all-in-one to either tone dialing or pulse dialing. Most telephone systems work with either type of dialing. If your telephone system does not require pulse dialing, we recommend using tone dialing. If you have a public telephone system or a private branch exchange (PBX) system, you may need to select **Pulse Dialing**. Contact your local telephone company if you are unsure which setting to use.

**Note** If you select **Pulse Dialing**, some phone system features might not be available. It can also take longer to dial a fax or phone number.

- 1 Press **Setup**.
- 2 Press **4**, and then press **5**.  
This selects **Basic Fax Setup** and then selects **Tone or Pulse Dialing**.
- 3 Press **▶** to select an option, and then press **OK**.

## Adjust the volume

Your HP all-in-one provides three levels for adjusting the ring and speaker volume. The ring volume is the volume of the phone rings. The speaker volume is the level of everything else, such as the dial tones, fax tones, and button press beeps. The default setting is **Soft**.

- 1 Press **Setup**.
- 2 Press **4**, and then press **6**.  
This selects **Basic Fax Setup** and then selects **Ring and Beep Volume**.
- 3 Press **▶** to select one of the options: **Soft**, **Loud**, or **Off**.

**Note** If you select **Off**, you will not hear a dial tone, fax tones, or incoming ring tones.

- 4 Press **OK**.

## Forward faxes to another number

You can set up your HP all-in-one to forward your faxes to another fax number. If a color fax is received, the fax is forwarded in black and white.

**Note** When the HP all-in-one is forwarding your faxes, it will not print the faxes it receives unless there was a problem. If the HP all-in-one is not able to forward the fax to the designated fax machine (if it is not turned on, for example), the HP all-in-one will print the fax and an error report.

We recommend that you verify the number you are forwarding to works. Send a test fax to make sure the fax machine is able to receive your forwarded faxes.

### To forward faxes from the control panel

- 1 Press **Setup**.
- 2 Press **4**, and then press **7**.  
This selects **Basic Fax Setup** and then selects **Fax Forwarding Black Only**.
- 3 Press **▶** until **On** appears, and then press **OK**.
- 4 At the prompt, enter the number of the fax machine that will receive the forwarded faxes.
- 5 Press **OK**.

Fax Forwarding appears on the control panel display.

## Cancel fax forwarding

You can cancel your fax forwarding setup from the control panel.

You can cancel your fax forwarding setup from the control panel or the **HP Director**. If you want to change the number of the fax machine you are forwarding your faxed to, use the **HP Director**.

### To cancel forward faxes from the control panel

→ Press **Cancel**, and then press **1**.

Fax forwarding is cancelled.

## Change the answer ring pattern (distinctive ringing)

Many phone companies offer a distinctive ringing feature that allows you to have several phone numbers on one phone line. When you subscribe to this service, each number will have a different ring pattern. For example, you can have single, double, and triple rings for the different numbers. You can set up your HP all-in-one to answer incoming calls that have a specific ring pattern.

If you connect your HP all-in-one to a line with distinctive ringing, have your telephone company assign one ring pattern to voice calls and another ring pattern to fax calls. We recommend that you request double or triple rings for a fax number. When the HP all-in-one detects the specified ring pattern, it will answer the call and receive the fax.

For example, you might have your telephone company assign double rings to your fax number and a single ring to your voice number. In this setup, set the **Answer Ring Pattern** for your HP all-in-one to **Double Rings**. You can also set the **Rings to Answer** setting to **3**. When a call comes in with a double ring, the HP all-in-one answers it after three rings and receives the fax.

If you do not have this service, use the default ring pattern, which is **All Rings**.

### To change the answer ring pattern from the control panel

- 1 Verify that your HP all-in-one is set to answer fax calls automatically. For information, see [Set the answer mode](#).
- 2 Press **Setup**.
- 3 Press **5**, and then press **1**.  
This selects **Advanced Fax Setup** and then selects **Answer Ring Pattern**.
- 4 Press **▶** to select an option, and then press **OK**.

When the phone rings with the ring pattern assigned to your fax phone line, the HP all-in-one answers the call and receives the fax.

## Redial a busy or unanswered number automatically

You can set your HP all-in-one to redial a busy or an unanswered number automatically. The default setting for **Busy Redial** is **Redial**. The default setting for **No Answer Redial** is **No Redial**.

- 1 Press **Setup**.
- 2 Do one of the following:
  - To change the **Busy Redial** setting, press **5**, and then press **2**.  
This selects **Advanced Fax Setup** and then selects **Busy Redial**.
  - To change the **No Answer Redial** setting press **5**, and then press **3**.

- This selects **Advanced Fax Setup** and then selects **No Answer Redial**.
- 3 Press **▶** to select **Redial** or **No Redial**.
  - 4 Press **OK**.

### Set automatic reduction for incoming faxes

This setting determines what your HP all-in-one does if it receives a fax that is too large for the default paper size. With this setting turned on (the default), the image of the incoming fax is reduced so that it fits on one page, if possible. With this feature turned off, information that does not fit on the first page is printed on a second page.

**Automatic Reduction** is useful when you receive a legal-size fax and letter-size paper is loaded in the input tray.

- 1 Press **Setup**.
- 2 Press **5**, and then press **4**.  
This selects **Advanced Fax Setup** and then selects **Automatic Reduction**.
- 3 Press **▶** to select **Off** or **On**.
- 4 Press **OK**.

### Set backup fax reception

The HP all-in-one stores all received faxes in memory. If there is an error condition that prevents the HP all-in-one from printing the faxes, **Backup Fax Reception** allows you to continue receiving faxes. During the error condition, with **Backup Fax Reception** enabled, the faxes are stored in memory.

For example, if the HP all-in-one is out of paper and **Backup Fax Reception** is enabled, all received faxes are stored in memory. After you load more paper, you can print the faxes. If you disable this feature, the HP all-in-one will not answer incoming fax calls until the error condition is resolved.

Error conditions, such as the following, may prevent the HP all-in-one from printing faxes:

- There is no paper loaded in the input tray
- There is a paper jam
- The print-carriage access door is open
- The print carriage is stalled

During normal operation (whether **Backup Fax Reception** is **On** or **Off**), the HP all-in-one stores all faxes in memory. After the memory becomes full, the HP all-in-one overwrites the oldest, printed faxes as it receives new faxes. If you want to delete all the faxes in memory, turn off the HP all-in-one by pressing the **On** button.

**Note** If **Backup Fax Reception** is **On** and there is an error condition, the HP all-in-one stores the faxes it receives in memory as "unprinted." All unprinted faxes remain in memory until they are printed or deleted. When the memory becomes full of unprinted faxes, the HP all-in-one will not receive any more fax calls until the unprinted faxes are printed or deleted from memory. For information on printing or deleting faxes from memory, see [Reprint or delete the faxes in memory](#).

The default **Backup Fax Reception** setting is **On**.

#### To set backup fax reception from the control panel

- 1 Press **Setup**.
- 2 Press **5**, and then press **5** again.



- This selects **Advanced Fax Setup** and then selects **Backup Fax Reception**.
- 3 Press **▶** to select **On** or **Off**.
- 4 Press **OK**.

### Use error correction mode

**Error Correction Mode (ECM)** eliminates data that is lost due to poor phone lines by detecting errors that occur during transmission and automatically requesting retransmission of the erroneous portion. Phone charges are unaffected, or might even be reduced, on good phone lines. On poor phone lines, ECM increases sending time and phone charges, but sends the data much more reliably. The default setting is on. Turn ECM off only if it increases phone charges substantially, and you can accept poorer quality in exchange for reduced charges.

The following rules apply to ECM:

- If you turn ECM off, this applies only to faxes that you send. This does not apply to faxes that you receive.
- If you turn ECM off, set the **Fax Speed** to **Medium**. If the **Fax Speed** is set to **Fast**, the fax will automatically be sent with ECM on. For information on changing the **Fax Speed**, see [Set the fax speed](#).
- If you send a fax in color, the fax will be sent with ECM on, regardless of the option currently set.

#### To change the ECM setting from the control panel

- 1 Press **Setup**.
- 2 Press **5**, and then press **6**.  
This selects **Advanced Fax Setup** and then selects **Error Correction Mode**.
- 3 Press **▶** to select **Off** or **On**.
- 4 Press **OK**.

### Set the fax speed

You can set the fax speed used to communicate between your HP all-in-one and other fax machines when sending and receiving faxes. The default fax speed is **Fast**.

If you use one of the following, setting the fax speed to a slower speed might be required:

- An Internet phone service
- A PBX system
- Fax over Internet Protocol (FoIP)
- An integrated services digital network (ISDN) service

If you experience problems sending and receiving faxes, you might want to try setting the **Fax Speed** setting to **Medium** or **Slow**. The following table provides the available fax speed settings.

| Fax speed setting | Fax speed         |
|-------------------|-------------------|
| Fast              | v.34 (33600 baud) |
| Medium            | v.17 (14400 baud) |
| Slow              | v.29 (9600 baud)  |

### To set the fax speed from the control panel

- 1 Press **Setup**.
- 2 Press **5**, and then press **7**.  
This selects **Advanced Fax Setup** and then selects **Fax Speed**.
- 3 Press **▶** to select an option, and then press **OK**.

## Reprint or delete the faxes in memory

You can reprint or delete the faxes stored in memory. You might need to reprint a fax in memory if your HP all-in-one runs out of paper while receiving a fax. Or, if the memory of the HP all-in-one becomes full, you might need to clear it in order to continue receiving faxes.

**Note** The HP all-in-one stores all faxes it receives in memory, even when the faxes are printed. This allows you to reprint the faxes later, if needed. After the memory becomes full, the HP all-in-one overwrites the oldest, printed faxes as it receives new faxes.

### To reprint faxes in memory from the control panel

- 1 Make sure you have paper loaded in the input tray.
- 2 Press **Setup**.
- 3 Press **6**, and then press **4**.  
This selects **Tools** and then selects **Reprint Faxes in Memory**.  
The faxes are printed in the reverse order they were received with the most recently received fax printed first, and so on.
- 4 If you do not need a fax that is printing, press **Cancel**.  
The HP all-in-one begins printing the next fax in memory.

**Note** You will need to press **Cancel** for each stored fax in order to stop it from printing.

### To delete all the faxes in memory from the control panel

- To delete all the faxes from memory, turn off the HP all-in-one by pressing the **On** button.

All faxes stored in memory will be deleted from memory after you turn off the power to your HP all-in-one.

## Fax over the Internet

You may subscribe to a low cost phone service that allows you to send and receive faxes with your HP all-in-one by using the Internet. This method is called Fax over Internet Protocol (FoIP). You probably use a FoIP service (provided by your telephone company) if you:

- Dial a special access code along with the fax number, or
- Have an IP converter box that connects to the Internet and provides analog phone ports for the fax connection.

**Note** You can only send and receive faxes by connecting a phone cord to the port labeled "1-LINE" on the HP all-in-one and not from the Ethernet port. This means that your connection to the Internet must be done either through a converter box (which supplies regular analog phone jacks for fax connections) or your telephone company.

The FoIP service might not work properly when the HP all-in-one is sending and receiving faxes at high speed (33600bps). If you experience problems sending and receiving faxes, use a slower fax speed. You can do this by changing the **Fax Speed** setting from **High** (the default) to **Medium**. For information on changing this setting, see [Set the fax speed](#).

You should also check with your telephone company to make sure their Internet phone service supports faxing. If they do not support faxing, you will not be able to send and receive faxes through the Internet.

## Stop faxing

You can cancel a fax you are sending or receiving at any time.

### To stop faxing from the control panel

- Press **Cancel** on the control panel to stop a fax you are sending or receiving. Look for the **Fax Cancelled** message on the control panel display. If it does not appear, press **Cancel** again.

The HP all-in-one prints any pages it has already started printing and then cancels the remainder of the fax. This can take a few moments.

### To cancel a number you are dialing

- Press **Cancel** to cancel a number you are currently dialing.

# 12 Use HP Instant Share

HP Instant Share makes it easy to share photos with family and friends. Just scan a photo, select a destination for your photo, and then send the photo on its way. You can even upload your photos to an online photo album or an online photo finishing service. Availability of services varies by country/region.

With **HP Instant Share E-mail**, family and friends always get photos they can view: no more large downloads or images that are too big to open. An e-mail message with thumbnail images of your photos is sent with a link to a secure Web page where family and friends can easily view, share, print, and save the photos.

## Overview

If your HP all-in-one is USB-connected, you can share photos with friends and relatives using your device and the HP software installed on your computer. If you have a Windows-based computer, use the **HP Image Zone** software; if you have a Macintosh, use the **HP Instant Share** client application software.

**Note** A USB-connected device is an HP All-in-One that is connected to a computer by means of a USB cable and relies on the computer for access to the Internet.

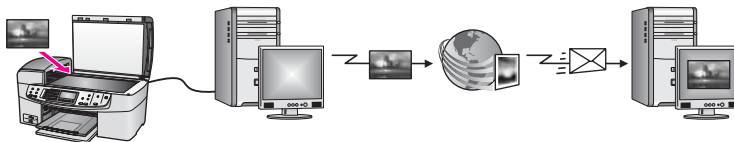

Use HP Instant Share to send images from your HP all-in-one to a destination of your choice. The destination, for example, can be an e-mail address, an online photo album, or an online photo finishing service. Availability of services varies by country/region.

**Note** You can also send images to a friend or relative's network-connected HP All-in-One or photo printer. To send to a device, you must have an HP Passport user ID and password. The receiving device must be set up and registered with HP Instant Share. You will also need to obtain the name the recipient assigned to the receiving device. Further instructions are provided in step 6 in [Send images using your HP all-in-one](#).

## Get started

You must have the following to use HP Instant Share with your HP all-in-one:

- An HP all-in-one connected to a computer with a USB cable
- Internet access through the computer to which the HP all-in-one is connected
- **HP Image Zone** software installed on your computer. Macintosh users will find that the **HP Instant Share** client application software is also installed.

Once you have set up your HP all-in-one and installed the **HP Image Zone** software, you are ready to start sharing photos using HP Instant Share. For more information on setting up your HP all-in-one, see the Setup Guide that came with your device.

## Send images using your HP all-in-one

Images can be photos or scanned documents. Either can be shared with friends and relatives using your HP all-in-one and HP Instant Share.

Share a scanned image by pressing **Scan To** on the control panel. To use **Scan To**, place an image face down on the glass, select a destination to which you want to send the image, and start the scan.

**Note** For more information on scanning an image, see [Use the scan features](#).

### To send a scanned image from your HP all-in-one

- 1 Load your original face down on the right front corner of the glass or (if you are using the automatic document feeder) in the document tray.
- 2 Press **Scan To** on the control panel of your HP all-in-one.  
The **Scan To** menu appears on the color graphics display.
- 3 Use the ◀ and ▶ arrows to highlight **HP Instant Share**.
- 4 Press **OK** or **Start Scan** to select the destination.  
The image is scanned and uploaded to your computer.

**Note** If an original is detected in the automatic document feeder, one or more pages are scanned. If no original is detected in the automatic document feeder, a single page is scanned from the scanner bed.

For Windows users, the **HP Image Zone** software opens on your computer. The **HP Instant Share** tab appears. A thumbnail of the scanned image appears in the Selection Tray. For more information on the **HP Image Zone**, see **Use the HP Image Zone** in the onscreen help.

For Macintosh users, the **HP Instant Share** client application software opens on your computer. A thumbnail of the scanned image appears in the **HP Instant Share** window.

**Note** If you are using a Macintosh OS earlier than X v10.1.5 (including OS 9 v9.1.5), your photos are uploaded to the **HP Gallery** on your Macintosh. Click **E-mail**. Send the scanned image as an e-mail attachment by following the prompts on your computer screen.

- 5 Follow the steps appropriate for your operating system:

#### If you are using a Windows-based computer:

- a From either the **Control** or **Work** areas of the **HP Instant Share** tab, click the link or icon of the service you want to use to send your scanned image.

**Note** If you click **See All Services**, you can choose from among all of the services available in your country/region, for example: **HP Instant Share E-mail** and **Create Online Albums**. Follow the onscreen instructions.

The **Go Online** screen appears in the Work area.

- b Click **Next** and follow the onscreen instructions.

#### If you are using a Macintosh:

- a Make sure the scanned image you want to share displays in the **HP Instant Share** window.

Use the - button to remove photos, or the + button to add photos to the window.

- b Click **Continue** and follow the onscreen instructions.
  - c From the HP Instant Share services list, select the service you want to use to send your scanned image.
  - d Follow the onscreen instructions.
- 6 From the **HP Instant Share E-mail** service, you can:
- Send an e-mail message with thumbnail images of your photos which can be viewed, printed, and saved over the Web.
  - Open and maintain an e-mail address book. Click **Address Book**, register with HP Instant Share, and create an HP Passport account.
  - Send your e-mail message to multiple addresses. Click the related link.
  - Send a collection of images to a friend or relative's network-connected device. Enter the name assigned to the device by the recipient in the **E-mail address** field followed by @send.hp.com. You will be prompted to sign in to HP Instant Share with your HP Passport **userid** and **password**.

**Note** If you have not previously set up HP Instant Share, click **I need an HP Passport account** on the **Sign in with HP Passport** screen. Obtain an HP Passport user ID and password.

## Send images using your computer

In addition to using your HP all-in-one to send images through HP Instant Share, you can use the **HP Image Zone** software installed on your computer to send images. The **HP Image Zone** software lets you select and edit one or more images, and then access HP Instant Share to select a service (for example, **HP Instant Share E-mail**) and send your images. At a minimum, you can share images through the following:

- HP Instant Share E-mail (send to an e-mail address)
- HP Instant Share E-mail (send to a device)
- Online Albums
- Online photo finishing (availability varies by country/region)

### Send images using the HP Image Zone software (Windows)

Use the **HP Image Zone** software to share images with friends and relatives. Simply open the **HP Image Zone**, select the images you want to share, and forward the images using the **HP Instant Share E-mail** service.

**Note** For more information on using the **HP Image Zone** software, see the onscreen **HP Image Zone Help**.

#### To use the HP Image Zone software

- 1 Double-click the **HP Image Zone** icon on your desktop. The **HP Image Zone** window opens on your computer. The **My Images** tab appears in the window.
- 2 Select one or more images from the folder(s) in which they are stored. For more information, see the onscreen **HP Image Zone Help**.

**Note** Use the **HP Image Zone** image editing tools to edit your images and achieve the results you want. For more information, see the onscreen **HP Image Zone Help**.

- 3 Click the **HP Instant Share** tab.  
The **HP Instant Share** tab appears in the **HP Image Zone** window.
- 4 From either the **Control** or **Work** areas of the **HP Instant Share** tab, click the link or icon of the service you want to use to send your scanned image.

**Note** If you click **See All Services**, you can choose from among all of the services available in your country/region, for example: **HP Instant Share E-mail** and **Create Online Albums**. Follow the onscreen instructions.

The **Go Online** screen appears in the **Work** area of the **HP Instant Share** tab.

- 5 Click **Next** and follow the onscreen instructions.
- 6 From the **HP Instant Share E-mail** service, you can:
  - Send an e-mail message with thumbnail images of your photos which can be viewed, printed, and saved over the Web.
  - Open and maintain an e-mail address book. Click **Address Book**, register with HP Instant Share, and create an HP Passport account.
  - Send your e-mail message to multiple addresses. Click the related link.
  - Send a collection of images to a friend or relative's network-connected device. Enter the name assigned to the device by the recipient in the **E-mail address** field followed by @send.hp.com. You will be prompted to sign in to HP Instant Share with your HP Passport **userid** and **password**.

**Note** If you have not previously set up HP Instant Share, click **I need an HP Passport account** on the **Sign in with HP Passport** screen. Obtain an HP Passport user ID and password.

### Send images using the HP Instant Share client application software (Macintosh OS X v10.1.5 and later)

**Note** Macintosh OS X v10.2.1 and v10.2.2 are **not** supported.

Use the HP Instant Share client application to share images with friends and relatives. Simply open the HP Instant Share window, select the images you want to share, and forward the images using the **HP Instant Share E-mail** service.

**Note** For more information on using the **HP Instant Share** client application software, see the onscreen **HP Image Zone Help**.

#### To use the HP Instant Share client application

- 1 Select the **HP Image Zone** icon from the Dock.  
The **HP Image Zone** opens on your desktop.
- 2 In the **HP Image Zone**, click the **Services** button at the top of the window.  
A list of applications appears in the lower part of the **HP Image Zone**.
- 3 Choose **HP Instant Share** from the list of applications.  
The **HP Instant Share** client application software opens on your computer.
- 4 Use the **+** button to add an image to the window, or the **-** button to remove an image.

**Note** For more information on using the **HP Instant Share** client application software, see the onscreen **HP Image Zone Help**.

- 5 Make sure the images you want to share display in the **HP Instant Share** window.
- 6 Click **Continue** and follow the onscreen instructions.

- 7 From the HP Instant Share services list, select the service you want to use to send your scanned image.
- 8 Follow the onscreen instructions.
- 9 From the **HP Instant Share E-mail** service, you can:
  - Send an e-mail message with thumbnail images of your photos which can be viewed, printed, and saved over the Web.
  - Open and maintain an e-mail address book. Click **Address Book**, register with HP Instant Share, and create an HP Passport account.
  - Send your e-mail message to multiple addresses. Click the related link.
  - Send a collection of images to a friend or relative's network-connected device. Enter the name assigned to the device by the recipient in the **E-mail address** field followed by @send.hp.com. You will be prompted to sign in to HP Instant Share with your HP Passport **userid** and **password**.

**Note** If you have not previously set up HP Instant Share, click **I need an HP Passport account** on the **Sign in with HP Passport** screen. Obtain an HP Passport user ID and password.

### Share images using the HP Director (Macintosh OS earlier than X v10.1.5)

**Note** Macintosh OS 9 v9.1.5 and later and v9.2.6 and later **are** supported. Macintosh OS X v10.0 and v10.0.4 are **not** supported.

Share images with anyone who has an e-mail account. Simply start the **HP Director** and open the **HP Gallery**. Then create a new e-mail message using an e-mail application installed on your computer.

**Note** For more information, see the HP Imaging Gallery section in the onscreen **HP Photo and Imaging Help**.

#### To use the e-mail option within the HP Director

- 1 Display the **HP Director** menu:
  - In OS X, select the **HP Director** icon from the Dock.
  - In OS 9, double-click the **HP Director** shortcut on your desktop.
- 2 Open the **HP Photo and Imaging Gallery**:
  - In OS X, select **HP Gallery** from the **Manage and Share** section of the **HP Director** menu.
  - In OS 9, click **HP Gallery**.
- 3 Select one or more images to share.  
For more information, see the onscreen **HP Photo and Imaging Help**.
- 4 Click **E-mail**.

The e-mail program on your Macintosh opens.

Send the images as an e-mail attachment by following the prompts on your computer screen.





# 13 Order supplies

You can order recommended types of HP paper and print cartridges online from the HP website.

## Order paper, transparency film, or other media

To order media such as HP Premium Paper, HP Premium Plus Photo Paper, HP Premium Inkjet Transparency Film, or HP Iron-On Transfer, go to [www.hp.com](http://www.hp.com). If prompted, choose your country/region, follow the prompts to select your product, and then click one of the shopping links on the page.

## Order print cartridges

To order print cartridges for your HP all-in-one, go to [www.hp.com](http://www.hp.com). If prompted, choose your country/region, follow the prompts to select your product, and then click one of the shopping links on the page.

Your HP all-in-one supports the following print cartridges:

| Print cartridges                    | HP reorder number  |
|-------------------------------------|--|
| HP black inkjet print cartridge     | <b>#338</b> , 16 ml black print cartridge  |
| HP tri-color inkjet print cartridge | <b>#344</b> , 16 ml color print cartridge<br><b>#343</b> , 11 ml color print cartridge |
| HP photo inkjet print cartridge     | <b>#348</b> , 15 ml color photo print cartridge  |

**Note** Print cartridge reorder numbers vary by country/region. If the reorder numbers listed in this guide do not match the numbers on the print cartridges currently installed in your HP all-in-one, order new print cartridges with the same numbers as those you currently have installed.

You can find out the reorder numbers for all the print cartridges your device supports through the **Printer Toolbox**. In the **HP Director**, click **Settings**, point to **Print Settings**, and then click **Printer Toolbox**. Click the **Estimated Ink Levels** tab, and then click **Print Cartridge Ordering Information**.

You can also contact a local HP reseller or go to [www.hp.com/support](http://www.hp.com/support) to confirm the correct print cartridge reorder numbers for your country/region.

## Order other supplies

To order other supplies, such as HP all-in-one software, a copy of the printed User Guide, a Setup Guide, or other customer-replaceable parts, call the appropriate number below:

- In the U.S. or Canada, dial **1-800-474-6836 (1-800-HP invent)**.
- In Europe, dial +49 180 5 290220 (Germany) or +44 870 606 9081 (U.K.).

To order HP all-in-one software in other countries/regions, call the phone number for your country/region. The numbers listed below are current as of the publication date of

this guide. For a list of current ordering numbers, go to [www.hp.com/support](http://www.hp.com/support). If prompted, choose your country/region, and then click **Contact HP** for information on calling for technical support.

| Country/region                  | Number for ordering                                   |
|---------------------------------|---|
| Asia Pacific (except for Japan) | 65 272 5300   |
| Australia                       | 131047  |
| Europe                          | +49 180 5 290220 (Germany)<br>+44 870 606 9081 (U.K.) |
| New Zealand                     | 0800 441 147  |
| South Africa                    | +27 (0)11 8061030                                     |
| U.S. and Canada                 | 1-800-HP-INVENT (1-800-474-6836)                      |

# 14 Maintain your HP all-in-one

The HP all-in-one requires little maintenance. Sometimes you might want to clean the glass and lid backing to remove surface dust and ensure that your copies and scans remain clear. You will also need to replace, align, or clean your print cartridges occasionally. This chapter provides instructions for keeping your HP all-in-one in top working condition. Perform these simple maintenance procedures as necessary.

## Clean the HP all-in-one

Fingerprints, smudges, hair, and other debris on the glass or lid backing slow down performance and affect the accuracy of special features such as **Fit to Page**. To ensure that your copies and scans remain clear, you might need to clean the glass and lid backing. You might also want to dust the exterior of the HP all-in-one.

### Clean the glass

Fingerprints, smudges, hair, and dust on the main glass surface slow down performance and affect the accuracy of features such as **Fit to Page**.

In addition to the main glass surface, you might also need to clean the small glass strip inside the automatic document feeder. Streaks can occur if the glass strip inside the automatic document feeder is dirty.

#### To clean the glass

- 1 Turn off the HP all-in-one, unplug the power cord, and raise the lid.

**Note** When you unplug the power cord, the date and time are erased. You will need to reset the date and time later, when you plug the power cord back in. Any faxes stored in memory are also erased.

- 2 Clean the glass with a soft cloth or sponge slightly moistened with a nonabrasive glass cleaner.



**Warning** Do not use abrasives, acetone, benzene, or carbon tetrachloride on the glass; they can damage it. Do not place or spray liquid directly on the glass; the liquid might seep under the glass and damage the device.

- 3 Dry the glass with a chamois or cellulose sponge to prevent spotting.

#### To clean the glass strip inside the automatic document feeder

- 1 Lift the cover of the automatic document feeder.

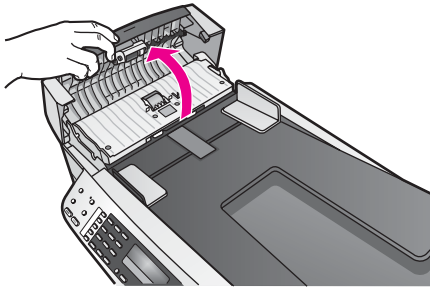

- 2 Raise the lid, as if you were loading an original on the glass.

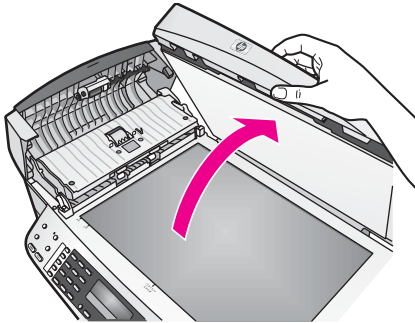

- 3 Lift the automatic document feeder mechanism.

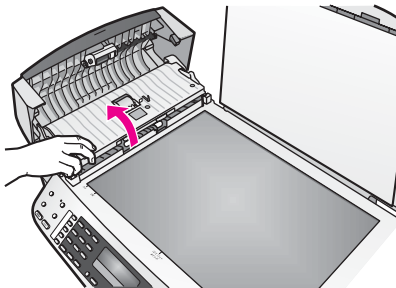

There is a glass strip under the automatic document feeder.

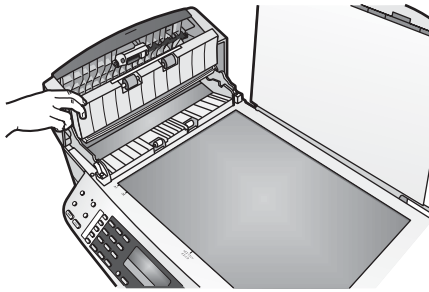

- 4 Clean the glass strip with a soft cloth or sponge slightly moistened with a nonabrasive glass cleaner.

 **Warning** Do not use abrasives, acetone, benzene, or carbon tetrachloride on the glass; they can damage it. Do not place or spray liquid directly on the glass; the liquid might seep under the glass and damage the device.

- 5 Lower the automatic document feeder mechanism, and then close the cover of the automatic document feeder.
- 6 Close the lid.

### Clean the lid backing

Minor debris can accumulate on the white document backing located underneath the lid of the HP all-in-one.

- 1 Turn off the HP all-in-one, unplug the power cord, and raise the lid.
- 2 Clean the white document backing with a soft cloth or sponge slightly moistened with a mild soap and warm water.
- 3 Wash the backing gently to loosen debris. Do not scrub the backing.
- 4 Dry the backing with a chamois or soft cloth.

 **Warning** Do not use paper-based wipes, as these might scratch the backing.

- 5 If further cleaning is needed, repeat the previous steps using isopropyl (rubbing) alcohol, and wipe the backing thoroughly with a damp cloth to remove any residual alcohol.

 **Warning** Be careful not to spill alcohol on the glass or painted parts of the HP all-in-one, as this might damage the device.

### Clean the exterior

Use a soft cloth or slightly moistened sponge to wipe dust, smudges, and stains off the case. The interior of the HP all-in-one does not require cleaning. Keep fluids away from the control panel and the interior of the HP all-in-one.

 **Warning** To avoid damage to painted parts of the HP all-in-one, do not use alcohol or alcohol-based cleaning products on the control panel, document feeder tray, lid, or other painted parts of the device.

## Print a self-test report

If you are experiencing problems with printing, print a self-test report before you replace the print cartridges. This report provides useful information on several aspects of your device, including your print cartridges.

- 1 Load letter, A4, or legal unused plain white paper into the input tray.
- 2 Press **Setup**.
- 3 Press **2**, then press **5**.

This selects **Print Report** and then selects **Self-Test Report**.

The HP all-in-one prints a self-test report, which might indicate the source of the printing problem. A sample of the ink test area of the report is shown below.

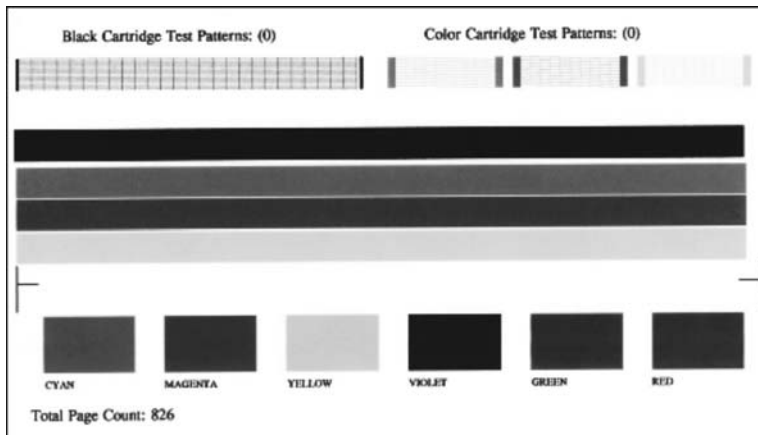

- 4 Make sure the test patterns are even and show a complete grid.  
If more than a few lines in a pattern are broken, this might indicate a problem with the nozzles. You might need to clean the print cartridges. For more information, see [Clean the print cartridges](#).
- 5 Make sure the lines of color extend across the page.  
If the black line is missing, faded, streaked, or shows lines, this might indicate a problem with the black or photo print cartridge in the right slot.  
If any of the remaining three lines are missing, faded, streaked, or show lines, this might indicate a problem with the tri-color print cartridge in the left slot.
- 6 Make sure the color blocks have even consistency and are representative of the colors listed below.

You should see cyan, magenta, yellow, violet, green, and red color blocks.

If color blocks are missing, or if a block of color is muddy or does not match the label indicated below the block, this might indicate that the tri-color print cartridge is out of ink. You might need to replace the print cartridge. For more information on replacing print cartridges, see [Replace the print cartridges](#).

- Note** For examples of test patterns, lines of color, and color blocks from normal and malfunctioning print cartridges, see the onscreen **HP Image Zone Help** that came with your software.

## Work with print cartridges

To ensure the best print quality from your HP all-in-one, you will need to perform some simple maintenance procedures. This section provides guidelines for handling the print cartridges and instructions for replacing, aligning, and cleaning the print cartridges.

### Handle the print cartridges

Before you replace or clean a print cartridge, you should know the part names and how to handle the print cartridges.

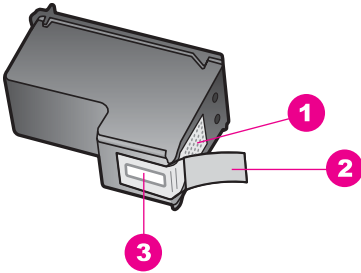

|   |   |
|---|---|
| 1 | Copper-colored contacts   |
| 2 | Plastic tape with pink pull tab (must be removed before installing) |
| 3 | Ink nozzles under tape  |

Hold the print cartridges by their black plastic sides, with the label on top. Do not touch the copper-colored contacts or the ink nozzles.

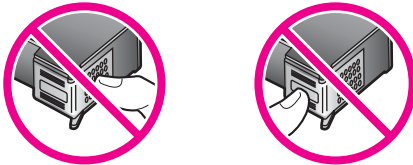

**Warning** Be careful not to drop the print cartridges. This can damage them, making them unusable.

### Replace the print cartridges

When the ink level for the print cartridge is low, a message appears on the control panel display.

**Note** You can also check the estimated amount of ink remaining in your cartridges by using the **HP Image Zone** software that came with your HP all-in-one. For information on checking the ink levels from the **HP Director**, see the onscreen **HP Image Zone Help** that came with your software.

When you receive a low-ink warning message on the control panel display, make sure you have a replacement print cartridge available. You should also replace the print



cartridges when you see faded text or if you experience print quality issues related to the print cartridges.

**Tip** You can also use these instructions to replace the black print cartridge with a photo print cartridge for printing high-quality color photos.

To find out the reorder number for all the print cartridges that your HP all-in-one supports, see [Order print cartridges](#). To order print cartridges for your HP all-in-one, go to [www.hp.com](http://www.hp.com). If prompted, choose your country/region, follow the prompts to select your product, and then click one of the shopping links on the page.

### To replace the print cartridges

- 1 Make sure the HP all-in-one is on.



**Warning** If the HP all-in-one is off when you lift the print-carriage access door to access the print cartridges, the HP all-in-one will not release the cartridges for changing. You might damage the HP all-in-one if the print cartridges are not docked safely on the right side when you try to remove them.

- 2 Open the print-carriage access door by lifting from the front center of the device, until the door locks into place. The print carriage moves to the far right side of the HP all-in-one.

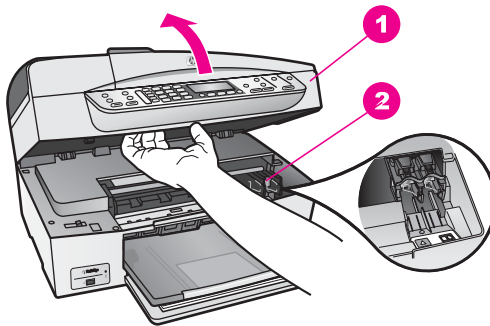

|   |                            |
|---|----------------------------|
| 1 | Print-carriage access door |
| 2 | Print carriage             |

- 3 Wait until the print carriage is idle and silent, and then lightly press down on a print cartridge to release it.

If you are replacing the tri-color print cartridge, remove the print cartridge from the slot on the left.

If you are replacing the black or photo print cartridge, remove the print cartridge from the slot on the right.

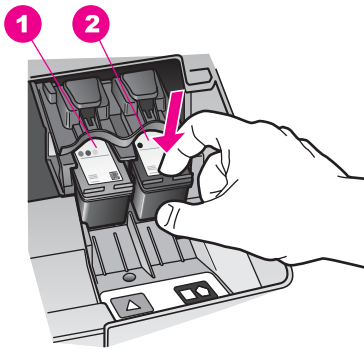

|   |   |
|---|---|
| 1 | Print cartridge slot for the tri-color print cartridge        |
| 2 | Print cartridge slot for the black and photo print cartridges |

- 4 Pull the print cartridge toward you out of its slot.
- 5 If you are removing the black print cartridge in order to install the photo print cartridge, store the black print cartridge in the print cartridge protector. For more information, see [Use the print cartridge protector](#).  
If you are removing the print cartridge because it is low or out of ink, recycle the print cartridge. The HP Inkjet Supplies Recycling Program is available in many countries/regions, and lets you recycle used print cartridges free of charge. For more information, go to the following website:  
[www.hp.com/hpinfo/globalcitizenship/environment/recycle/inkjet.html](http://www.hp.com/hpinfo/globalcitizenship/environment/recycle/inkjet.html)
- 6 Remove the new print cartridge from its packaging and, being careful to touch only the black plastic, gently remove the plastic tape by using the pink pull tab.

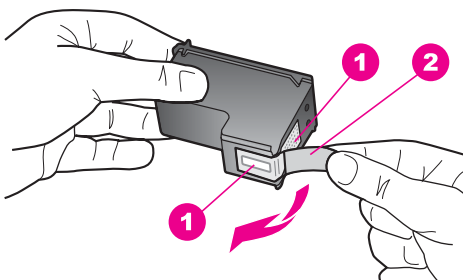

|   |   |
|---|---|
| 1 | Copper-colored contacts   |
| 2 | Plastic tape with pink pull tab (must be removed before installing) |
| 3 | Ink nozzles under tape  |

**Caution** Do not touch the copper-colored contacts or ink nozzles. Touching these parts can result in clogs, ink failure, and bad electrical connections.



- 7 Slide the new print cartridge forward into the empty slot. Push the print cartridge forward until it clicks into place.
- If the print cartridge you are installing has a white triangle on its label, slide the print cartridge into the slot on the left. The label for the slot is green with a solid white triangle.
- If the print cartridge you are installing has a white square or a white pentagon on its label, slide the print cartridge into the slot on the right. The label for the slot is black with a solid white square and a solid white pentagon.

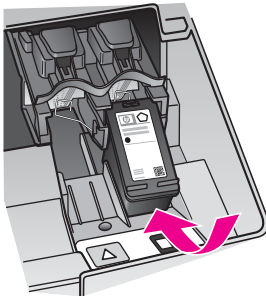

- 8 Close the print-carriage access door.

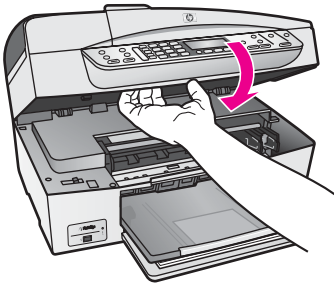

### Use a photo print cartridge

You can optimize the quality of the color photos you print and copy with your HP all-in-one by purchasing a photo print cartridge. Remove the black print cartridge and insert the photo print cartridge in its place. With the tri-color print cartridge and photo print cartridge installed, you have a six-ink system, which provides enhanced quality color photos.

When you want to print regular text documents, swap the black print cartridge back in. Use a print cartridge protector to keep your print cartridge secure when it is not being used.

- For more information on purchasing a photo print cartridge, see [Order print cartridges](#).
- For more information on replacing print cartridges, see [Replace the print cartridges](#).
- For more information on using the print cartridge protector, see [Use the print cartridge protector](#).

## Use the print cartridge protector

In some countries/regions, when you purchase a photo print cartridge, you might also receive a print cartridge protector. In other countries/regions, a print cartridge protector comes in the box with your HP all-in-one. If neither your print cartridge nor your HP all-in-one came with a print cartridge protector, you can order one from HP Support. Go to [www.hp.com/support](http://www.hp.com/support).

The print cartridge protector is designed to keep a print cartridge secure and prevent it from drying out when it is not being used. Whenever you remove a print cartridge from the HP all-in-one with the intention of using it again later, store it in the print cartridge protector. For example, store the black print cartridge in a print cartridge protector if you are removing it so you can print high-quality photos with the photo and tri-color print cartridges.

### To insert a print cartridge into the print cartridge protector

- Slide the print cartridge into the print cartridge protector at a slight angle and snap it securely into place.

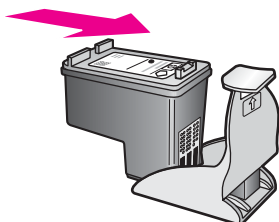

### To remove the print cartridge from the print cartridge protector

- Press down and back on the top of the print cartridge protector to release the print cartridge, then slide the print cartridge out of the print cartridge protector.

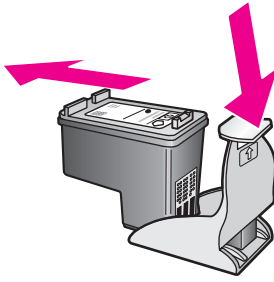

## Align the print cartridges

The HP all-in-one prompts you to align cartridges every time you install or replace a print cartridge. You can also align the print cartridges at any time from the control panel or by using the **HP Image Zone** software on your computer. Aligning the print cartridges ensures high-quality output.

**Note** If you remove and reinstall the same print cartridge, the HP all-in-one will not prompt you to align the print cartridges. The HP all-in-one remembers the alignment values for that print cartridge, so you do not need to realign the print cartridges.

### To align the print cartridges from the control panel when prompted

- Make sure you have letter or A4 unused plain white paper loaded in the input tray, and then press **OK**.

The HP all-in-one prints a print cartridge alignment sheet and aligns the print cartridges. Recycle or discard the page.

**Note** If you have colored paper loaded in the input tray when you align the print cartridges, the alignment will fail. Load unused plain white paper into the input tray, and then try the alignment again.

If the alignment fails again, you might have a defective sensor or print cartridge. Contact HP Support. Go to [www.hp.com/support](http://www.hp.com/support). If prompted, choose your country/region, and then click **Contact HP** for information on calling for technical support.

### To align the cartridges from the control panel at any other time

- 1 Load letter or A4 unused plain white paper into the input tray.
- 2 Press **Setup**.
- 3 Press **6**, then press **2**.

This selects **Tools** and then selects **Align Print Cartridge**.

The HP all-in-one prints a print cartridge alignment sheet and aligns the print cartridges. Recycle or discard the page.

For information on aligning the print cartridges by using the **HP Image Zone** software that came with your HP all-in-one, see the onscreen **HP Image Zone Help** that came with your software.

## Clean the print cartridges

Use this feature when the self-test report shows streaking or white lines through any of the lines of color. Do not clean print cartridges unnecessarily, as this wastes ink and shortens the life of the ink nozzles.

### To clean the print cartridges from the control panel

- 1 Load letter or A4 unused plain white paper into the input tray.
- 2 Press **Setup**.
- 3 Press **6**, then press **1**.

This selects **Tools** and then selects **Clean Print Cartridge**.

The HP all-in-one prints a page that you can recycle or discard.

If copy or print quality still seem poor after you clean the print cartridges, try cleaning the print cartridge contacts before replacing the affected print cartridge. For information on cleaning the print cartridge contacts, see [Clean the print cartridge contacts](#). For information on replacing the print cartridges, see [Replace the print cartridges](#).

For information on cleaning the print cartridges by using the **HP Image Zone** software that came with your HP all-in-one, see the onscreen **HP Image Zone Help** that came with your software.

## Clean the print cartridge contacts

Clean the print cartridge contacts only if you get repeated messages on the control panel display prompting you to check a print cartridge after you already have cleaned or aligned the print cartridges.

Before cleaning the print cartridge contacts, remove the print cartridge and verify that nothing is covering the print cartridge contacts, then reinstall the print cartridge. If you continue to get messages to check the print cartridges, clean the print cartridge contacts.

Make sure you have the following materials available:

- Dry foam rubber swabs, lint-free cloth, or any soft material that will not come apart or leave fibers.
- Distilled, filtered, or bottled water (tap water might contain contaminants that can damage the print cartridges).



**Warning** Do **not** use platen cleaners or alcohol to clean the print cartridge contacts. These can damage the print cartridge or the HP all-in-one.

### To clean the print cartridge contacts

- 1 Turn on the HP all-in-one and open the print-carriage access door. The print carriage moves to the far right side of the HP all-in-one.
- 2 Wait until the print carriage is idle and silent, and then unplug the power cord from the back of the HP all-in-one.

**Note** When you unplug the power cord, the date and time are erased. You will need to reset the date and time later, when you plug the power cord back in. For more information, see [Set the date and time](#). Any faxes stored in memory are also erased.

- 3 Lightly press down on the print cartridge to release it, and then pull it toward you out of the slot.
- Note** Do not remove both print cartridges at the same time. Remove and clean each print cartridge one at a time. Do not leave a print cartridge outside the HP all-in-one for more than 30 minutes.
- 4 Inspect the print cartridge contacts for ink and debris buildup.
  - 5 Dip a clean foam rubber swab or lint-free cloth into distilled water, and squeeze any excess water from it.
  - 6 Hold the print cartridge by its sides.
  - 7 Clean only the copper-colored contacts. For information on cleaning the ink nozzle area, see [Clean the area around the ink nozzles](#).

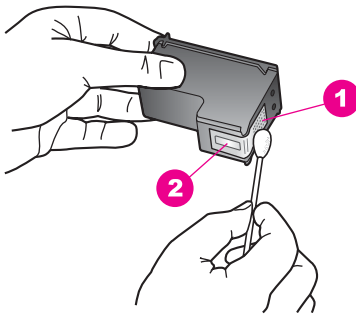

|   |                            |
|---|----------------------------|
| 1 | Copper-colored contacts    |
| 2 | Ink nozzles (do not clean) |

- 8 Slide the print cartridge back into the slot. Push the print cartridge forward until it clicks into place.
- 9 Repeat if necessary for the other print cartridge.
- 10 Gently close the print-carriage access door and plug the power cord into the back of the HP all-in-one.

### Clean the area around the ink nozzles

If the HP all-in-one is used in a dusty environment, a small amount of debris might accumulate inside the device. This debris can include dust, hair, carpet, or clothing fibers. When debris gets on the print cartridges, it can cause ink streaks and smudges on printed pages. Ink streaking can be corrected by cleaning around the ink nozzles as described here.

**Note** Clean the area around the ink nozzles only if you continue to see streaks and smudges on your printed pages after you have already cleaned the print cartridges by using the control panel or the **HP Image Zone**. For more information, see [Clean the print cartridges](#).

Make sure you have the following materials available:

- Dry foam rubber swabs, lint-free cloth, or any soft material that will not come apart or leave fibers.
- Distilled, filtered, or bottled water (tap water might contain contaminants that can damage the print cartridges).

**Warning** Do **not** touch the copper-colored contacts or ink nozzles. Touching these parts can result in clogs, ink failure, and bad electrical connections.

### To clean the area around the ink nozzles

- 1 Turn on the HP all-in-one and open the print-carriage access door. The print carriage moves to the far right side of the HP all-in-one.
- 2 Wait until the print carriage is idle and silent, and then unplug the power cord from the back of the HP all-in-one.

**Note** When you unplug the power cord, the date and time are erased. You will need to reset the date and time later, when you plug the power cord back in. For more information, see [Set the date and time](#). Any faxes stored in memory are also erased.

- 3 Lightly press down on the print cartridge to release it, and then pull it toward you out of the slot.

**Note** Do not remove both print cartridges at the same time. Remove and clean each print cartridge one at a time. Do not leave a print cartridge outside the HP all-in-one for more than 30 minutes.

- 4 Place the print cartridge on a piece of paper with the ink nozzles facing up.
- 5 Lightly moisten a clean foam rubber swab with distilled water.
- 6 Clean the face and edges around the ink nozzle area with the swab, as shown below.

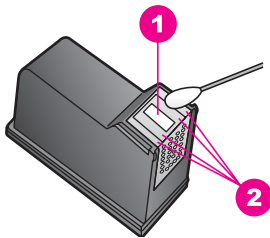

|   |   |
|---|---|
| 1 | Nozzle plate (do not clean)               |
| 2 | Face and edges around the ink nozzle area |

**Warning** Do **not** clean the nozzle plate.

- 7 Slide the print cartridge back into the slot. Push the print cartridge forward until it clicks into place.
- 8 Repeat if necessary for the other print cartridge.
- 9 Gently close the print-carriage access door and plug the power cord into the back of the HP all-in-one.



## Change the device settings

You can change the scroll speed and prompt delay time settings on your HP all-in-one so that it behaves according to your preference. You can also restore the device settings to what they were when you purchased your device. This will erase any new defaults you have set.

### Set the scroll speed

The **Scroll Speed** option lets you control the rate that text messages scroll from right to left in the control panel display. For example, if the message is "Pass. Refer to printed report for Fax Test details. Press OK to continue.", it will not completely fit in the control panel display and will need to scroll. This is so that you can read the entire message. You can choose the rate at which it will scroll: **Normal**, **Fast**, or **Slow**. The default is **Normal**.

- 1 Press **Setup**.
- 2 Press **7**, then press **2**.  
This selects **Preferences** and then selects **Set Scroll Speed**.
- 3 Press **▶** to select a scroll speed, then press **OK**.

### Set the prompt delay time

The **Prompt Delay Time** option allows you to control the amount of time that passes before a message prompts you to take further action. For example, if you press **Menu** in the Copy area and the prompt delay time passes without you pressing another button, the message "Press Menu for more options." appears in the control panel display. You can choose **Normal**, **Fast**, **Slow**, or **Off**. If you select **Off**, hints will not appear on the control panel display but other messages, such as low ink warnings and error messages, will still appear.

- 1 Press **Setup**.
- 2 Press **7**, then press **3**.  
This selects **Preferences** and then selects **Set Prompt Delay Time**.
- 3 Press **▶** to select a delay time, then press **OK**.

### Restore the factory defaults

You can restore the original factory settings to what they were when you purchased your HP all-in-one.

**Note** Restoring the factory defaults will not affect any changes you made to scan settings and the language and country/region settings.

You can perform this process from the control panel only.

- 1 Press **Setup**.
- 2 Press **6**, then press **3**.  
This selects **Tools** and then selects **Restore Factory Defaults**.

# 15 Troubleshooting information

This chapter contains troubleshooting information for the HP all-in-one. Specific information is provided for installation and configuration issues, and some operational topics. For more troubleshooting information, see the onscreen **HP Image Zone Help**.

Many issues are caused when the HP all-in-one is connected to the computer using a USB cable before the HP all-in-one software is installed on the computer. If you connected the HP all-in-one to your computer before the software installation screen prompts you to do so, you must follow these steps:

- 1 Disconnect the USB cable from the computer.
- 2 Uninstall the software (if you have already installed it).
- 3 Restart your computer.
- 4 Turn off the HP all-in-one, wait one minute, then restart it.
- 5 Reinstall the HP all-in-one software. Do not connect the USB cable to the computer until prompted by the software installation screen.

For information about uninstalling and reinstalling the software, see [Uninstall and reinstall the software](#).

This chapter contains the following topics:

- **Setup troubleshooting:** Contains information on hardware setup, software installation, and fax setup troubleshooting information.
- **Operational troubleshooting:** Contains information on issues that may occur during normal tasks when using the HP all-in-one features.
- **Device update:** Based on advice from HP customer support or a message on the control panel display, you might access the HP support website to retrieve an upgrade for your device. This section contains information about updating your device.

## Before you call HP Support

If you have a problem, follow these steps:

- 1 Check the documentation that came with the HP all-in-one.
  - **Setup Guide:** The Setup Guide explains how to set up the HP all-in-one.
  - **User Guide:** The User Guide is the book you are reading. This book describes the basic features of the HP all-in-one, explains how to use the HP all-in-one without connecting it to a computer, contains setup and operational troubleshooting information, and contains device update information.
  - **HP Image Zone Help:** The onscreen **HP Image Zone Help** describes how to use the HP all-in-one with a computer and contains additional troubleshooting information not covered in the User Guide.
  - **Readme file:** The Readme file contains information on possible installation problems and system requirements. For more information, see [View the Readme file](#).
- 2 If you are unable to solve the problem using the information in the documentation, visit [www.hp.com/support](http://www.hp.com/support) to do the following:
  - Access online support pages
  - Send HP an e-mail message for answers to your questions

- Connect with an HP technician by using online chat
- Check for software updates

Support options and availability vary by product, country/region, and language.

- 3 Contact your local point of purchase. If the HP all-in-one has a hardware failure, you will be asked to bring the HP all-in-one to where you purchased it. Service is free during the HP all-in-one limited warranty period. After the warranty period, you will be quoted a service charge.
- 4 If you are unable to solve the problem using the onscreen Help or HP websites, call HP Support using the number for your country/region. For more information, see [Get HP support](#).

## View the Readme file

You might want to refer to the Readme file for more information on possible installation problems and system requirements.

- In Windows, you can access the Readme file from Windows taskbar by clicking **Start**, pointing to **Programs** or **All Programs**, pointing to **Hewlett-Packard**, pointing to **HP Officejet 6200 series all-in-one**, and then clicking **View the Readme File**. If you have not yet installed the software and want to view the Readme file, follow the Macintosh instructions below.
- In Macintosh OS 9 or OS X, you can access the Readme file by double-clicking the icon located in the top-level folder of the HP all-in-one software CD-ROM.

## Setup troubleshooting

This section includes installation and configuration troubleshooting tips for some of the most common issues associated with hardware, software, and fax features of the HP all-in-one.

### Hardware setup troubleshooting

Use this section to solve any problems you might encounter while setting up the HP all-in-one hardware.

#### My HP all-in-one does not turn on

##### Solution

Make sure each of the power cords is firmly connected, and wait a few seconds for the HP all-in-one to turn on. If this is the first time you have turned on the HP all-in-one, it can take up to a minute to turn on. Make sure the green light on the power adaptor is illuminated. Also, if the HP all-in-one is plugged in to a power strip, make sure the power strip is turned on.

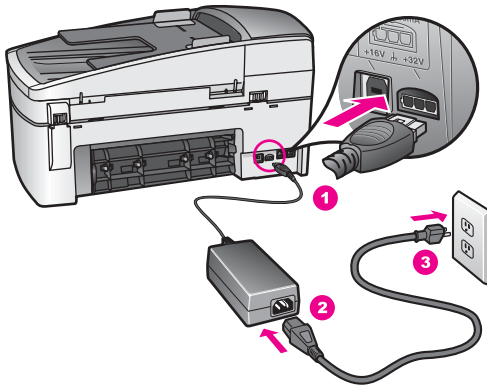

I connected the USB cable, but I am having problems using the HP all-in-one with my computer

### Solution

You must first install the software that came with your HP all-in-one before connecting the USB cable. During installation, do not plug in the USB cable until prompted by the onscreen instructions. Connecting the USB cable before prompted can cause errors.

Once you have installed the software, connecting your computer to your HP all-in-one with a USB cable is straightforward. Simply plug one end of the USB cable into the back of your computer and the other into the back of the HP all-in-one. You can connect to any USB port on the back of your computer.

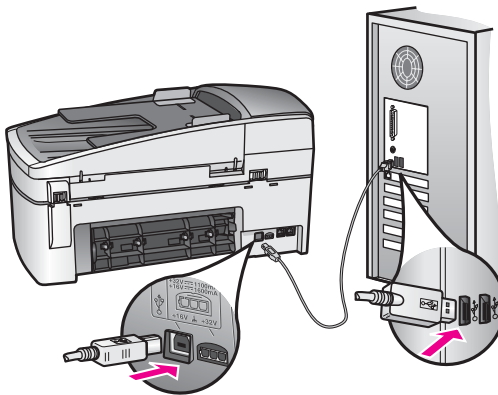

I received a message on the control panel display to attach the control panel overlay

### Solution

This might mean the control panel overlay is not attached, or it is attached incorrectly. Make sure to align the overlay over the buttons on the top of the HP all-in-one and snap it firmly into place.

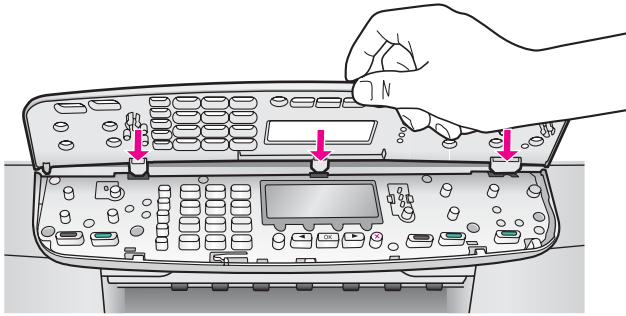

### The control panel display shows the wrong language

#### Solution

Usually, you set the language and country/region when you first set up the HP all-in-one. However, you can change these settings at any time by using the following procedure:

- 1 Press **Setup**.
- 2 Press **7**, and then press **1**.  
This selects **Preferences**, and then selects **Set Language & Country/Region**. A list of languages appears. You can scroll through the list of languages by pressing the ◀ and ▶ arrows.
- 3 When your language is highlighted, press **OK**.
- 4 When prompted, press **1** for Yes or **2** for No.  
The countries/regions for the selected language appear. Press ◀ or ▶ to scroll through the list.
- 5 Use the keypad to enter the two-digit number for the appropriate country/region.
- 6 When prompted, press **1** for Yes or **2** for No.

### The wrong measurements are showing in menus on the control panel display

#### Solution

You may have selected the incorrect country/region when setting up your HP all-in-one. The country/region you select determines the paper sizes shown on the control panel display.

To change the country/region, you must first set the default language again. Usually, you set the language and country/region when you first set up the HP all-in-one. However, you can change these settings at any time by using the following procedure:

- 1 Press **Setup**.
- 2 Press **7**, and then press **1**.  
This selects **Preferences**, and then selects **Set Language & Country/Region**. A list of languages appears. You can scroll through the list of languages by pressing the ◀ and ▶ arrows.
- 3 When your language is highlighted, press **OK**.
- 4 When prompted, press **1** for Yes or **2** for No.

- The countries/regions for the selected language appear. Press ◀ or ▶ to scroll through the list.
- 5 Use the keypad to enter the two-digit number for the appropriate country/region.
  - 6 When prompted, press **1** for Yes or **2** for No.

### I received a message on the control panel display to align the print cartridges

#### Solution

The HP all-in-one prompts you to align cartridges every time you install a new print cartridge. For more information, see [Align the print cartridges](#).

**Note** If you remove and reinstall the same print cartridge, the HP all-in-one will not prompt you to align the print cartridges. The HP all-in-one remembers the alignment values for that print cartridge, so you do not need to realign the print cartridges.

### I received a message on the control panel display that the print cartridge alignment failed

#### Cause

The incorrect type of paper is loaded in the input tray.

#### Solution

If you have colored paper loaded in the input tray when you align the print cartridges, the alignment fails. Load unused plain white letter or A4 paper into the input tray, and then try the alignment again. If the alignment fails again, you might have a defective sensor or print cartridge.

Contact HP Support. Go to [www.hp.com/support](http://www.hp.com/support). If prompted, choose your country/region, and then click **Contact HP** for information on calling for technical support.

---

#### Cause

Protective tape is covering the print cartridges.

#### Solution

Check each print cartridge. If the plastic tape is still covering the ink nozzles, gently remove the plastic tape by using the pink pull tab. Do not touch the ink nozzles or the copper-colored contacts.

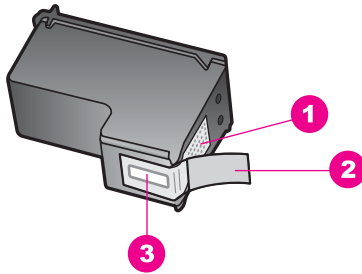

|   |   |
|---|---|
| 1 | Copper-colored contacts   |
| 2 | Plastic tape with pink pull tab (must be removed before installing) |
| 3 | Ink nozzles under tape  |

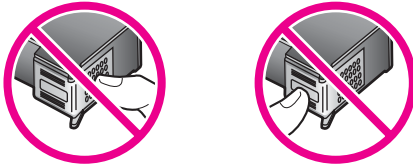

Reinsert the print cartridges and verify that they are fully inserted and locked in place.

### Cause

The contacts on the print cartridge are not touching the contacts in the print carriage.

### Solution

Remove and then reinsert the print cartridges. Verify that they are fully inserted and locked in place.

### Cause

The print cartridge or sensor is defective.

### Solution

Contact HP Support. Go to [www.hp.com/support](http://www.hp.com/support). If prompted, choose your country/region, and then click **Contact HP** for information on calling for technical support.

## The HP all-in-one does not print

### Solution

If your HP all-in-one and computer are not communicating with each other, try the following:

- Check that the HP all-in-one print queue is not paused (Windows) or stopped (Macintosh). If it is, choose the appropriate setting to resume printing. For

more information about accessing the print queue, see the documentation that came with the operating system installed on your computer.

- Check the USB cable. If you are using an older cable, it might not be working properly. Try connecting it to another product to see if the USB cable works. If you experience problems, the USB cable might need to be replaced. Also verify that the cable does not exceed 3 meters (9.8 feet) in length.
- Make sure your computer is USB ready. Some operating systems, such as Windows 95 and Windows NT, do not support USB connections. Check the documentation that came with your operating system for more information.
- Check the connection from your HP all-in-one to your computer. Verify that the USB cable is securely plugged into the USB port on the back of your HP all-in-one. Make sure the other end of the USB cable is plugged into a USB port on your computer. After the cable is connected properly, turn your HP all-in-one off and then on again.

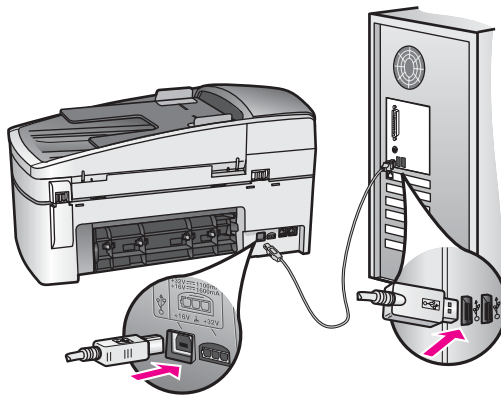

- Check other printers or scanners. You might need to disconnect older products from your computer.
- After you check the connections, try restarting your computer. Turn your HP all-in-one off and then on again.
- If necessary, remove and then install the **HP Image Zone** software again. For more information, see [Uninstall and reinstall the software](#).

For more information on setting up your HP all-in-one and connecting it to your computer, see the Setup Guide that came with your HP all-in-one.

### **I received a message on the control panel display about a paper jam or a blocked carriage**

#### **Solution**

If either a paper jam or blocked carriage error message appears on the control panel display, there might be some packing material inside the HP all-in-one. Lift open the print-carriage access door. The orange shipping lock might still be in place on the left side of the HP all-in-one. Pull out the orange shipping lock and throw it away.



## Software installation troubleshooting

If you encounter a problem during software installation, see the topics below for a possible solution. If you encounter a hardware problem during setup, see [Hardware setup troubleshooting](#).

During a normal installation of the HP all-in-one software, the following events occur:

- 1 The HP all-in-one software CD-ROM runs automatically.
- 2 The software installs.
- 3 Files are copied to your hard drive.
- 4 You are requested to connect the HP all-in-one to your computer.
- 5 A green OK and check mark appear on an installation wizard screen.
- 6 You are requested to restart your computer.
- 7 The Fax Setup wizard runs.
- 8 The registration process runs.

If any of these things did not occur, there might be a problem with the installation. To check the installation on a PC, verify the following:

- Start the **HP Director** and check to make sure the following icons appear: **Scan Picture**, **Scan Document**, **Send Fax** and **HP Gallery**. For information on starting **HP Director**, see the onscreen **HP Image Zone Help** that came with your software. If the icons do not appear immediately, you might need to wait a few minutes for the HP all-in-one to connect to your computer. Otherwise, see [Some of the icons are missing in the HP Director](#).

**Note** If you performed a minimum installation of the software (as apposed to a typical installation), the **HP Image Zone** and **Copy** are not installed and will not be available from the **HP Director**.

- Open the Printers dialog box and check to see that the HP all-in-one is listed.
- Look in the system tray at the far right of the Windows taskbar for an HP all-in-one icon. This indicates that the HP all-in-one is ready.

### When I insert the CD-ROM into my computer's CD-ROM drive, nothing happens (Windows only)

#### Solution

Do the following:

- 1 From the Windows **Start** menu, click **Run**.
- 2 In the **Run** dialog box, enter **d:\setup.exe** (if your CD-ROM drive is not assigned to drive letter D, enter the appropriate drive letter), and then click **OK**.

### The minimum system checks screen appears

#### Solution

Your system does not meet the minimum requirements to install the software. Click **Details** to see what the specific problem is, and then correct the problem before attempting to install the software.

### A red X appears on the USB connect prompt

## Solution

Normally, a green check appears indicating that the plug and play is successful. A red X indicates that the plug and play failed.

Do the following:

- 1 Verify that the control panel overlay is firmly attached, unplug the HP all-in-one power cable, and then plug it in again.
- 2 Verify that the USB and power cables are plugged in.

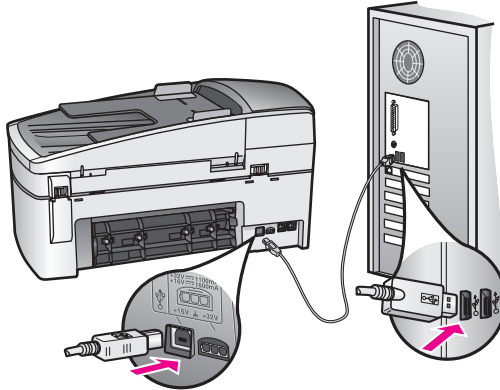

- 3 Click **Retry** to retry the plug and play setup. If this does not work, continue to the next step.
- 4 Verify that the USB cable is set up properly as follows:
  - Unplug the USB cable and plug it in again.
  - Do not attach the USB cable to a keyboard or non-powered hub.
  - Verify that the USB cable is 3 meters or less in length.
  - If you have several USB devices attached to your computer, you might want to unplug the other devices during the installation.
- 5 Continue with the installation and restart the computer when prompted. Then open **HP Director** and check for the essential icons (**Scan Picture**, **Scan Document**, **Send Fax**, and **HP Gallery**).
- 6 If the essential icons do not appear, remove the software and then reinstall it. For more information, see [Uninstall and reinstall the software](#).

## I received a message that an unknown error has occurred

### Solution

Try to continue with the installation. If that doesn't work, stop and then restart the installation, and follow the directions on the screen. If an error occurs, you might need to uninstall and then reinstall the software. Do not simply delete the HP all-in-one program files from your hard drive. Make sure to remove them properly using the uninstall utility provided in the HP all-in-one program group.

For more information, see [Uninstall and reinstall the software](#).

## Some of the icons are missing in the HP Director

If the essential icons (**Scan Picture**, **Scan Document**, **Send Fax**, and **HP Gallery**) do not appear, your installation might not be complete.

### Solution

If your installation is incomplete, you might need to uninstall and then reinstall the software. Do not simply delete the HP all-in-one program files from your hard drive. Make sure to remove them properly using the uninstall utility provided in the HP all-in-one program group. For more information, see [Uninstall and reinstall the software](#).

### The fax wizard does not start

#### Solution

Launch the fax wizard as follows:

- 1 Start the **HP Director**. For more information, see the onscreen **HP Image Zone Help** that came with your software.
- 2 Click the **Settings** menu, select **Fax Settings and Setup**, then select **Fax Setup Wizard**.

### The registration screen does not appear (Windows only)

#### Solution

→ In Windows, you can access the registration screen from the Windows taskbar by clicking Start, pointing to **Programs** or **All Programs** (XP), **Hewlett-Packard**, **HP Officejet 6200 series all-in-one**, and then clicking **Sign up now**.

### The Digital Imaging Monitor does not appear in the system tray (Windows only)

#### Solution

If the Digital Imaging Monitor does not appear in the system tray, start the **HP Director** to check whether or not essential icons are there. For more information about starting the **HP Director**, see the onscreen **HP Image Zone Help** that came with your software.

For more information about missing essential icons in the **HP Director**, see [Some of the icons are missing in the HP Director](#).

The system tray normally appears in the lower-right corner of the desktop.



### Uninstall and reinstall the software

If your installation is incomplete, or if you connected the USB cable to the computer before prompted by the software installation screen, you might need to uninstall and then reinstall the software. Do not simply delete the HP all-in-one program files from your hard drive. Make sure to remove them properly using the uninstall utility provided in the HP all-in-one program group.

A reinstall can take from 20 to 40 minutes for both Windows and Macintosh computers. There are three methods to uninstall the software on a Windows computer.

### To uninstall from a Windows computer, method 1

- 1 Disconnect your HP all-in-one from your computer. Do not connect the HP all-in-one to your computer until after you have reinstalled the software.
- 2 On the Windows taskbar, click **Start, Start Programs** or **All Programs (XP), Hewlett-Packard, HP Officejet 6200 series all-in-one, uninstall software**.
- 3 Follow the onscreen instructions.
- 4 If you are asked whether you would like to remove shared files, click **No**. Other programs that use these files might not work properly if the files are deleted.
- 5 Restart your computer.

**Note** It is important that you disconnect your HP all-in-one before restarting your computer. Do not connect the HP all-in-one to your computer until after you have reinstalled the software.

- 6 To reinstall the software, insert the HP all-in-one CD-ROM into your computer's CD-ROM drive, and follow the onscreen instructions and the instructions provided in the Setup Guide that came with your HP all-in-one.
- 7 After the software is installed, connect the HP all-in-one to your computer.
- 8 Press the **On** button to turn the HP all-in-one on.  
After connecting and turning on your HP all-in-one, you might have to wait several minutes for all of the Plug and Play events to complete.
- 9 Follow the onscreen instructions.

When the software installation is complete, the Status Monitor icon appears in the Windows system tray.

To verify that the software is properly installed, double-click the **HP Director** icon on the desktop. If the **HP Director** shows the key icons (**Scan Picture, Scan Document, Send Fax,** and **HP Gallery**), the software has been properly installed.

### To uninstall from a Windows computer, method 2

**Note** Use this method if **Uninstall Software** is not available in the Windows Start menu.

- 1 On the Windows taskbar, click **Start, Settings, Control Panel**.
- 2 Double-click **Add/Remove Programs**.
- 3 Select **HP all-in-one & Officejet 4.0**, and then click **Change/Remove**.  
Follow the onscreen instructions.
- 4 Disconnect your HP all-in-one from your computer.
- 5 Restart your computer.

**Note** It is important that you disconnect your HP all-in-one before restarting your computer. Do not connect the HP all-in-one to your computer until after you have reinstalled the software.

- 6 Launch setup.
- 7 Follow the onscreen instructions and the instructions provided in the Setup Guide that came with your HP all-in-one.

### To uninstall from a Windows computer, method 3

**Note** This is an alternate method if **Uninstall Software** is not available in the Windows Start menu.

- 1 Run the HP Officejet 6200 series all-in-one software Setup program.
- 2 Select **Uninstall** and follow the onscreen directions.
- 3 Disconnect your HP all-in-one from your computer.
- 4 Restart your computer.

**Note** It is important that you disconnect your HP all-in-one before restarting your computer. Do not connect the HP all-in-one to your computer until after you have reinstalled the software.

- 5 Run the HP Officejet 6200 series all-in-one software Setup program again.
- 6 Launch **Reinstall**.
- 7 Follow the onscreen instructions and the instructions provided in the Setup Guide that came with your HP all-in-one.

### To uninstall from a Macintosh computer

- 1 Disconnect the HP all-in-one from your Macintosh.
- 2 Double-click the **Applications: HP All-in-One Software** folder.
- 3 Double-click **HP Uninstaller**.  
Follow the onscreen instructions.
- 4 After the software is uninstalled, disconnect your HP all-in-one, and then restart your computer.

**Note** It is important that you disconnect your HP all-in-one before restarting your computer. Do not connect the HP all-in-one to your computer until after you have reinstalled the software.

- 5 To reinstall the software, insert the HP all-in-one CD-ROM into your computer's CD-ROM drive.
- 6 On the desktop, open the CD-ROM and then double-click **HP all-in-one installer**.
- 7 Follow the onscreen instructions and the instructions provided in the Setup Guide that came with your HP all-in-one.

## Fax setup troubleshooting

This section contains fax setup troubleshooting information for the HP all-in-one. If your HP all-in-one is not set up properly for faxing, you might experience problems when sending faxes, receiving faxes, or both.

**Tip** This section contains only setup-related troubleshooting. For additional fax troubleshooting topics, such as problems with your printouts or slow fax reception, see the onscreen Troubleshooting Help that came with your **HP Image Zone** software.

If you are having faxing problems, you can print a fax test report to check the status of your HP all-in-one. The test will fail if your HP all-in-one is not set up properly for faxing. Perform this test after you have completed setting up your HP all-in-one for faxing.

### To test your fax setup

- 1 Press **Setup**.

- 2 Press **6**, and then press **5**.  
This displays the **Tools** menu and then selects **Run Fax Test**.  
The HP all-in-one displays the status of the test on the control panel display and prints a report.
- 3 Review the report.
  - If the test passes and you are still having problems faxing, check the fax settings listed in the report to verify the settings are correct. A blank or incorrect fax setting can cause faxing problems.
  - If the test fails, review the report for information on how to fix any problems found. For more information, you can also see the next section, [The fax test failed](#).
- 4 Press **OK** to return to the **Setup Menu**.

If you are still experiencing faxing problems, continue with the following sections for more troubleshooting help.

### The fax test failed

If you ran a fax test and the test failed, review the report for basic information about the error. For more detailed information, check the report to see which part of the test failed, and then navigate to the appropriate topic in this section for information:

- [The fax hardware test failed](#)
- [The fax connected to active telephone wall jack test failed](#)
- [The phone cord connected to correct port on fax test failed](#)
- [The fax line condition test failed](#)
- [The dial tone detection test failed](#)

### The fax hardware test failed

#### Solution

- Turn off the HP all-in-one by using the **On** button located on the control panel and then unplug the power cord from the back of the HP all-in-one. After a few seconds, plug the power cord back in and turn the power on. Run the test again. If the test fails again, continue reviewing the troubleshooting information in this section.
- Try to send or receive a test fax. If you can send or receive a fax successfully, there might not be a problem.
- If you have a Windows computer and are running the test from the **Fax Setup Wizard**, make sure the HP all-in-one is not busy completing another task, such as receiving a fax or making a copy. Check the control panel display for a message indicating that the HP all-in-one is busy. If it is busy, wait until it is finished and in the idle state, before running the test.

After you resolve any problems found, run the fax test again to make sure it passes and your HP all-in-one is ready for faxing. If the **Fax Hardware Test** continues to fail and you experience problems faxing, contact HP for support. For information on contacting HP for support, see [Get HP support](#).

### The fax connected to active telephone wall jack test failed

### Solution

- Check the connection between the telephone wall jack and the HP all-in-one to make sure the phone cord is secure.
- Make sure you use the phone cord that came with your HP all-in-one. If you do not use the supplied phone cord to connect from the telephone wall jack to your HP all-in-one, you may not be able to send or receive faxes. After you plug in the phone cord that came with your HP all-in-one, run the fax test again.
- Make sure you have correctly connected the HP all-in-one to the telephone wall jack. Using the phone cord supplied in the box with your HP all-in-one, connect one end to your telephone wall jack, then connect the other end to the port labeled "1-LINE" on the back of your HP all-in-one. For more information on setting up your HP all-in-one for faxing, see [Fax setup](#).
- If you are using a phone splitter, this can cause faxing problems. (A splitter is a two-cord connector that plugs into a telephone wall jack.) Try removing the splitter and connecting the HP all-in-one directly to the telephone wall jack.
- Try connecting a working phone and phone cord to the telephone wall jack that you are using for the HP all-in-one and check for a dial tone. If you do not hear a dial tone, contact your telephone company and have them check the line.
- Try to send or receive a test fax. If you can send or receive a fax successfully, there might not be a problem.

After you resolve any problems found, run the fax test again to make sure it passes and your HP all-in-one is ready for faxing.

### The phone cord connected to correct port on fax test failed

#### Solution

The phone cord is plugged into the wrong port on the back of the HP all-in-one.

- 1 Using the phone cord supplied in the box with your HP all-in-one, connect one end to your telephone wall jack, then connect the other end to the port labeled "1-LINE" on the back of your HP all-in-one.

**Note** If you use the "2-EXT" port to connect to the telephone wall jack, you will not be able to send or receive faxes. The "2-EXT" port should only be used to connect other equipment, such as an answering machine or a telephone.

- 2 After you have connected the phone cord to the port labeled "1-LINE", run the fax test again to make sure it passes and your HP all-in-one is ready for faxing.
- 3 Try to send or receive a test fax.

### The fax line condition test failed

#### Solution

- Make sure you connect your HP all-in-one to an analog phone line or you will not be able to send or receive faxes. To check if your phone line is digital, connect a regular analog phone to the line and listen for a dial tone. If you do not hear a normal sounding dial tone, it might be a phone line set up for digital

phones. Connect your HP all-in-one to an analog phone line and try sending or receiving a fax.

- Check the connection between the telephone wall jack and the HP all-in-one to make sure the phone cord is secure.
- Make sure you have correctly connected the HP all-in-one to the telephone wall jack. Using the phone cord supplied in the box with your HP all-in-one, connect one end to your telephone wall jack, then connect the other end to the port labeled "1-LINE" on the back of your HP all-in-one. For more information on setting up your HP all-in-one for faxing, see [Fax setup](#).
- Other equipment, which uses the same phone line as the HP all-in-one, might be causing the test to fail. To find out if other equipment is causing a problem, disconnect everything from the phone line, and then run the test again.
  - If the **Fax Line Condition Test** passes without the other equipment, then one or more pieces of the equipment is causing problems; try adding them back one at a time and rerunning the test each time, until you identify which piece of equipment is causing the problem.
  - If the **Fax Line Condition Test** fails without the other equipment, connect the HP all-in-one to a working phone line and continue reviewing the troubleshooting information in this section.
- If you are using a phone splitter, this can cause faxing problems. (A splitter is a two-cord connector that plugs into a telephone wall jack.) Try removing the splitter and connecting the HP all-in-one directly to the telephone wall jack.

After you resolve any problems found, run the fax test again to make sure it passes and your HP all-in-one is ready for faxing. If the **Fax Line Condition** test continues to fail and you experience problems faxing, contact your telephone company and have them check the phone line.

### The dial tone detection test failed

#### Solution

- Other equipment, which uses the same phone line as the HP all-in-one, might be causing the test to fail. To find out if other equipment is causing a problem, disconnect everything from the phone line, and then run the test again. If the **Dial Tone Detection Test** passes without the other equipment, then one or more pieces of the equipment is causing problems; try adding them back one at a time and rerunning the test each time, until you identify which piece of equipment is causing the problem.
- Try connecting a working phone and phone cord to the telephone wall jack that you are using for the HP all-in-one and check for a dial tone. If you do not hear a dial tone, contact your telephone company and have them check the line.
- Make sure you have correctly connected the HP all-in-one to the telephone wall jack. Using the phone cord supplied in the box with your HP all-in-one, connect one end to your telephone wall jack, then connect the other end to the port labeled "1-LINE" on the back of your HP all-in-one. For more information on setting up your HP all-in-one for faxing, see [Fax setup](#).
- If you are using a phone splitter, this can cause faxing problems. (A splitter is a two-cord connector that plugs into a telephone wall jack.) Try removing the splitter and connecting the HP all-in-one directly to the telephone wall jack.



- If your telephone system is not using a standard dial tone, such as some PBX systems, this may cause the test to fail. This will not cause a problem sending or receiving faxes. Try sending or receiving a test fax.
- Check to make sure the country/region setting is set appropriately for your country/region. If the country/region setting is not set or is not set correctly, the test may fail and you might have problems sending and receiving faxes. For information on changing the country/region setting, see the Setup Guide that came with your HP all-in-one.
- Make sure you connect your HP all-in-one to an analog phone line or you will not be able to send or receive faxes. To check if your phone line is digital, connect a regular analog phone to the line and listen for a dial tone. If you do not hear a normal sounding dial tone, it might be a phone line set up for digital phones. Connect your HP all-in-one to an analog phone line and try sending or receiving a fax.

After you resolve any problems found, run the fax test again to make sure it passes and your HP all-in-one is ready for faxing. If the **Dial Tone Detection** test continues to fail, contact your telephone company and have them check the phone line.

### The HP all-in-one is having problems sending and receiving faxes

#### Solution

**Note** This possible solution applies only in the countries/regions that receive a 2-wire phone cord in the box with the HP all-in-one, including: Argentina, Australia, Brazil, Canada, Chile, China, Colombia, Greece, India, Indonesia, Ireland, Japan, Korea, Latin America, Malaysia, Mexico, Philippines, Poland, Portugal, Russia, Saudi Arabia, Singapore, Spain, Taiwan, Thailand, USA, Venezuela, and Vietnam.

- Make sure you used the phone cord supplied in the box with your HP all-in-one to connect to the telephone wall jack. One end of this special 2-wire cord should be connected to the port labeled "1-LINE" on the back of your HP all-in-one and the other end to your telephone wall jack, as shown below.

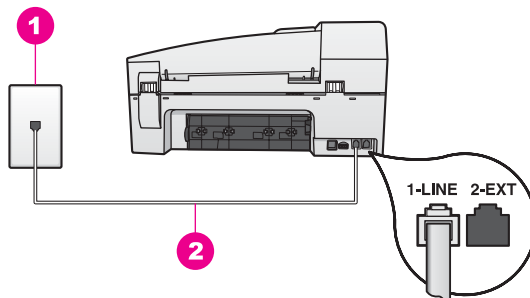

|   |  |
|---|--|
| 1 | Telephone wall jack                                    |
| 2 | Phone cord supplied in the box with your HP all-in-one |

This special 2-wire cord is different from the more common 4-wire phone cords you might already have in your home or office. Check the end of the cord and compare it to the two types of cords shown below.

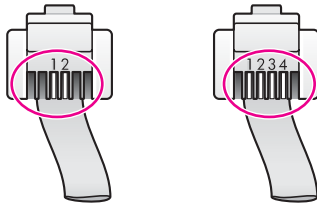

If you used the 4-wire phone cord, disconnect it, find the supplied 2-wire cord, and then connect the 2-wire cord to the port labeled "1-LINE" on the back of your HP all-in-one. For more information on connecting this phone cord and setting up your HP all-in-one for faxing, see [Fax setup](#).

If the supplied phone cord is not long enough, you can extend it. For information see [The phone cord that came with my HP all-in-one is not long enough](#).

- Try connecting a working phone and phone cord to the telephone wall jack that you are using for the HP all-in-one and check for a dial tone. If you do not hear a dial tone, contact your telephone company and have them check the line.
- Other equipment, which uses the same phone line as the HP all-in-one, might be in use. For example, you cannot use your HP all-in-one for faxing if an extension phone is off hook, or if you are using your PC modem to send an e-mail or access the Internet.
- The phone line connection might be noisy. Phone lines with poor sound quality (noise) can cause faxing problems. Check the sound quality of the phone line by plugging a phone into the telephone wall jack and listening for static or other noise. If you hear noise, turn **Error Correction Mode** (ECM) off and try faxing again. For information, see [Use error correction mode](#). If the problem persists, contact your telephone company.
- If you are using a digital subscriber line (DSL) service, make sure that you have a DSL filter connected or you will not be able to fax successfully. The DSL filter removes the digital signal and allows your HP all-in-one to communicate properly with the phone line. Obtain a DSL filter from your DSL provider. If you already have a DSL filter, make sure it is connected correctly. For information, see [Case B: Set up your HP all-in-one with DSL](#).
- Make sure your HP all-in-one is not connected to a telephone wall jack that is set up for digital phones. To check if your phone line is digital, connect a regular analog phone to the line and listen for a dial tone. If you do not hear a normal sounding dial tone, it might be a phone line set up for digital phones.
- If you are using either a private branch exchange (PBX) or an integrated services digital network (ISDN) converter/terminal adapter, make sure the HP all-in-one is connected to the port that is designated for fax and phone use. Also, make sure that the terminal adapter is set to the correct switch type for your country/region, if possible.

Note that some ISDN systems allow you to configure the ports for specific phone equipment. For example, you might have assigned one port for

telephone and Group 3 fax and another port for multiple purposes. If you continue to have problems when connected to the fax/phone port, try using the port designated for multiple purposes; it might be labeled "multi-combi" or something similar. For information on setting up your HP all-in-one with a PBX phone system or ISDN line, see [Fax setup](#).

- If your HP all-in-one shares the same phone line with a DSL service, the DSL modem might not be properly grounded. If the DSL modem is not properly grounded, it can create noise on the phone line. Phone lines with poor sound quality (noise) can cause faxing problems. You can check the sound quality of the phone line by plugging a phone into the telephone wall jack and listening for static or other noise. If you hear noise, turn off your DSL modem and completely remove power for at least 15 minutes. Turn the DSL modem back on and listen to the dial tone again.

**Note** You might notice static on the phone line again in the future. If your HP all-in-one stops sending and receiving faxes, repeat this process.

If the phone line is still noisy or for more information on turning your DSL modem off, contact your DSL provider for support. You can also contact your telephone company.

- If you are using a phone splitter, this can cause faxing problems. (A splitter is a two-cord connector that plugs into a telephone wall jack.) Try removing the splitter and connecting the HP all-in-one directly to the telephone wall jack.

### The HP all-in-one is having problems sending a manual fax

#### Solution

- Make sure the telephone you use to initiate the fax call is connected directly to the HP all-in-one. To send a fax manually, the telephone must be connected directly to the port labeled "2-EXT" on the HP all-in-one, as shown below. For information on sending faxes manually, see [Send a fax manually from a phone](#).

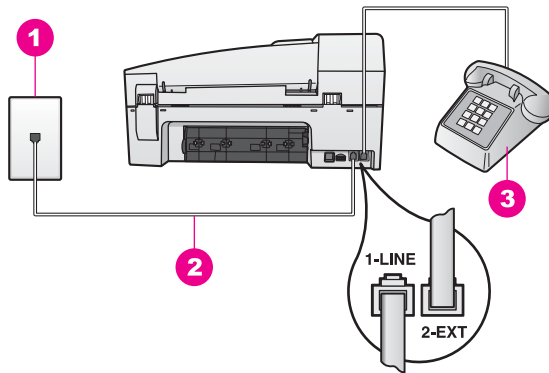

|   |  |
|---|--|
| 1 | Telephone wall jack                                    |
| 2 | Phone cord supplied in the box with your HP all-in-one |
| 3 | Telephone  |

- If you are sending a fax manually from your phone that is connected directly to the HP all-in-one, you must use the keypad on the telephone to send the fax. You cannot use the keypad on the control panel of the HP all-in-one.

### The HP all-in-one cannot receive faxes, but can send faxes

#### Solution

- If you are not using a distinctive ring service, check to make sure that the **Answer Ring Pattern** feature on your HP all-in-one is set to **All Rings**. For information, see [Change the answer ring pattern \(distinctive ringing\)](#).
- If **Auto Answer** is set to **Off**, you will need to manually receive faxes; otherwise, your HP all-in-one will not receive the fax. For information on receiving faxes manually, see [Receive a fax manually](#).
- If you have a voice mail service at the same phone number you use for fax calls, you must receive faxes manually, not automatically. This means that you must be available to respond in person to incoming fax calls. For information on setting up your HP all-in-one when you have a voice mail service, see [Fax setup](#). For information on receiving faxes manually, see [Receive a fax manually](#).
- If you have a PC modem on the same phone line with your HP all-in-one, check to make sure that the PC modem software is not set to receive faxes automatically. Modems with the auto fax receive feature turned on will receive all incoming faxes, which prevents the HP all-in-one from receiving fax calls.
- If you have an answering machine on the same phone line with your HP all-in-one, you might have one of the following problems:
  - Your answering machine might not be set up properly with your HP all-in-one.
  - Your outgoing message might be too long or too loud to allow the HP all-in-one to detect fax tones, and the calling fax machine might disconnect.
  - Your answering machine might hang up too quickly after the outgoing message plays if it does not detect someone trying to record a message, as when a fax is calling. This prevents the HP all-in-one from detecting the fax tones. This problem is most common with digital answering machines.

The following actions might help solve these problems:

- When you have an answering machine on the same phone line you use for fax calls, try connecting the answering machine directly to the HP all-in-one as described in [Fax setup](#).
- Make sure your HP all-in-one is set to receive faxes automatically. For information on setting up your HP all-in-one to receive faxes automatically, see [Set up the HP all-in-one to receive faxes](#).
- Make sure the **Rings to Answer** setting is correct. Set your answering machine to answer in 4 rings and your HP all-in-one to answer in the maximum number of rings supported by your device. (The maximum number of rings varies by country/region.) In this setup, the answering machine will answer the call and the HP all-in-one will monitor the line. If the HP all-in-one detects fax tones, the HP all-in-one will receive the fax. If the call is a voice call, the answering machine will record the incoming message. For information on setting the number of rings to answer, see [Set the number of rings before answering](#).
- Disconnect the answering machine and then try receiving a fax. If you can receive a fax without the answering machine, the answering machine might be causing the problem.
- Reconnect the answering machine and rerecord your outgoing message. Make sure the message is as short as possible (no more than 10 seconds long), and that you speak softly and slowly when recording it. At the end of your outgoing message, record an additional 4 - 5 seconds of silence with no background noise. Try to receive a fax again.

**Note** Some digital answering machines might not retain the recorded silence at the end of your outgoing message. Play back your outgoing message to check.

- If your HP all-in-one shares the same phone line with other types of phone equipment, such as an answering machine, a PC modem, or multi-port switch box, the fax signal level might be reduced. This can cause problems during fax reception.

To find out if other equipment is causing a problem, disconnect everything except the HP all-in-one from the phone line, and then try to receive a fax. If you can receive faxes successfully without the other equipment, one or more pieces of the other equipment is causing problems; try adding them back one at a time and receiving a fax each time, until you identify which equipment is causing the problem.

- If you have a special ring pattern for your fax phone number (using a distinctive ring service through your telephone company), make sure that the **Answer Ring Pattern** feature on your HP all-in-one is set to match. For example, if the telephone company has assigned your fax number a double ring pattern, make sure **Double Rings** is selected as the **Answer Ring Pattern** setting. For information on changing this setting, see [Change the answer ring pattern \(distinctive ringing\)](#).

**Note** The HP all-in-one cannot recognize some ring patterns, such as those with alternating short and long ringing patterns. If you are having problems with a ring pattern of this type, ask your telephone company to assign a non-alternating ring pattern.

## Fax tones are recorded on my answering machine

### Solution

- When you have an answering machine on the same phone line you use for fax calls, try connecting the answering machine directly to the HP all-in-one as described in [Fax setup](#). If you do not connect the answering machine as recommended, fax tones might be recorded on your answering machine.
- Make sure your HP all-in-one is set to receive faxes automatically. If your HP all-in-one is set up to receive faxes manually, the HP all-in-one will not answer incoming calls. You must be available to respond in person to incoming fax calls, or the HP all-in-one will not receive the fax and your answering machine will record the fax tones. For information on setting up your HP all-in-one to receive faxes automatically, see [Set up the HP all-in-one to receive faxes](#).
- Make sure the **Rings to Answer** setting is correct. The number of rings to answer for the HP all-in-one should be greater than the number of rings to answer for the answering machine. If the answering machine and the HP all-in-one are set to the same number of rings to answer, both devices will answer the call, and fax tones will be recorded on the answering machine.

Set your answering machine to answer in 4 rings and your HP all-in-one to answer in the maximum number of rings supported by your device. (The maximum number of rings varies by country/region.) In this setup, the answering machine will answer the call and the HP all-in-one will monitor the line. If the HP all-in-one detects fax tones, the HP all-in-one will receive the fax. If the call is a voice call, the answering machine will record the incoming message. For information on setting the number of rings to answer, see [Set the number of rings before answering](#).

## I hear static on my phone line since connecting the HP all-in-one

### Solution

**Note** This possible solution applies only in the countries/regions that receive a 2-wire phone cord in the box with the HP all-in-one, including: Argentina, Australia, Brazil, Canada, Chile, China, Colombia, Greece, India, Indonesia, Ireland, Japan, Korea, Latin America, Malaysia, Mexico, Philippines, Poland, Portugal, Russia, Saudi Arabia, Singapore, Spain, Taiwan, Thailand, USA, Venezuela, and Vietnam.

- If you did not connect the 2-wire cord (supplied in the box with your HP all-in-one) to the port labeled "1-LINE" on the back of your HP all-in-one to your telephone wall jack, you might hear static on your phone line and you probably will not be able to fax successfully. This special 2-wire cord is different from the more common 4-wire phone cords you might already have in your home or office.
- If you are using a phone splitter, this can cause static on the phone line. (A splitter is a two-cord connector that plugs into a telephone wall jack.) Try removing the splitter and connecting the HP all-in-one directly to the telephone wall jack.
- If you are not using a proper grounded power outlet for your HP all-in-one, you might hear static on your phone line. Try connecting to another power outlet.

## The phone cord that came with my HP all-in-one is not long enough

### Solution

If the phone cord that came with your HP all-in-one is not long enough, you can use a coupler to extend the length. You can purchase a coupler at an electronics store that carries phone accessories. You will also need another phone cord, which can be a standard 4-wire phone cord that you might already have in your home or office.

**Tip** If your HP all-in-one came with a 2-wire phone cord adaptor, you can use it with a 4-wire phone cord to extend the length. For information on using the 2-wire phone cord adaptor, see the documentation that came with it.

### To extend your phone cord

- 1 Using the phone cord supplied in the box with your HP all-in-one, connect one end to the coupler, then connect the other end to the port labeled "1-LINE" on the back of your HP all-in-one.
- 2 Connect another phone cord to the open port on the coupler and to the telephone wall jack, as shown below.

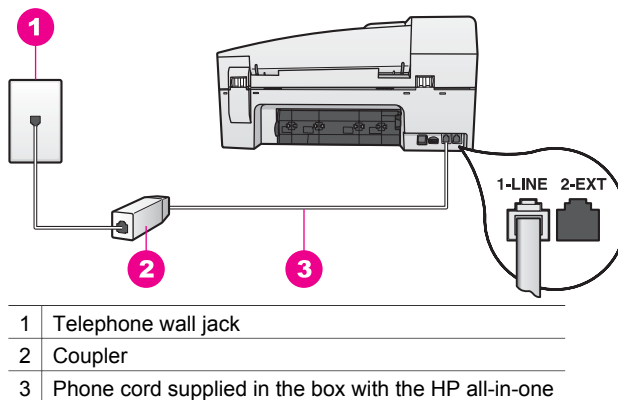

## I am having problems faxing over the Internet

### Solution

Check the following:

- The FoIP service might not work properly when the HP all-in-one is sending and receiving faxes at high speed (33600bps). If you experience problems sending and receiving faxes, use a slower fax speed. You can do this by changing the **Fax Speed** setting from **High** (the default) to **Medium**. For information on changing this setting, see [Set the fax speed](#).
- You can only send and receive faxes by connecting a phone cord to the port labeled "1-LINE" on the HP all-in-one and not from the Ethernet port. This means that your connection to the Internet must be done either through a

converter box (which supplies regular analog phone jacks for fax connections) or your telephone company.

- You should also check with your telephone company to make sure their Internet phone service supports faxing. If they do not support faxing, you will not be able to send and receive faxes through the Internet.

## Operational troubleshooting

This section contains information on: paper, print cartridge, and fax troubleshooting.

The troubleshooting section in the **HP Image Zone Help** contains more complete troubleshooting tips for some of the most common issues associated with your HP all-in-one.

To access the troubleshooting information from a Windows computer, go to the **HP Director**, click **Help**, and then choose **Troubleshooting and Support**.

Troubleshooting is also available through the Help button that appears on some error messages.

To access troubleshooting information from Macintosh OS X v10.1.5 and later, click the **HP Image Zone** icon in the Dock, select **Help** from the menu bar, choose **HP Image Zone Help** from the **Help** menu, and then choose **6200 series Troubleshooting** in the Help Viewer.

If you have Internet access, you can get help from the HP website at [www.hp.com/support](http://www.hp.com/support). The website also provides answers to frequently asked questions.

## Paper troubleshooting

To help avoid paper jams, only use paper types that are recommended for your HP all-in-one. For a list of recommended papers, see the onscreen **HP Image Zone Help**, or go to [www.hp.com/support](http://www.hp.com/support).

Do not load curled or wrinkled paper, or paper with bent or torn edges, into the input tray. For more information, see [Avoid paper jams](#).

If paper does become jammed in your device, follow these instructions to clear the paper jam.

### Paper has jammed the HP all-in-one

#### Solution

- 1 Press in the tab on the left side of the rear clean-out door to release the door. Remove the door by pulling it away from the HP all-in-one.

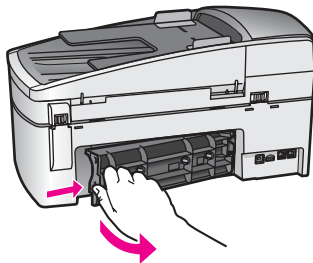



**Caution** Trying to clear a paper jam from the front of the HP all-in-one can damage the print mechanism. Always access and clear paper jams through the rear clean-out door.

- 2 Gently pull the paper out of the rollers.

**Warning** If the paper tears when you are removing it from the rollers, check the rollers and wheels for torn pieces of paper that might be remaining inside the device. If you do not remove all the pieces of paper from the HP all-in-one, more paper jams are likely to occur.

- 3 Replace the rear clean-out door. Gently push the door forward until it snaps into place.
- 4 Press **OK** to continue the current job.

### Paper has jammed the automatic document feeder

#### Solution

- 1 Lift the cover of the automatic document feeder.

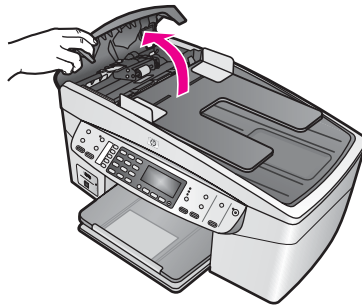

- 2 Gently pull the paper out of the rollers.

**Warning** If the paper tears when you are removing it from the rollers, check the rollers and wheels for torn pieces of paper that might be remaining inside the automatic document feeder. If you do not remove all the pieces of paper from the HP all-in-one, more paper jams are likely to occur.

- 3 Close the cover of the automatic document feeder.

### The automatic document feeder picks up too many pages or none at all

#### Cause

You need to clean the separator pad or rollers inside the automatic document feeder. Pencil lead, wax, or ink can build up on the rollers and separator pad after

extensive use, or if you copy handwritten originals or originals that are heavy with ink.

- If the automatic document feeder does not pick up any pages at all, the rollers inside the automatic document feeder need to be cleaned.
- If the automatic document feeder picks up multiple pages instead of single sheets, the separator pad inside the automatic document feeder needs to be cleaned.

### Solution

Load one or two sheets of unused plain white full-size paper into the document feeder tray, and then press **Start Copy Black** to pull the pages through the automatic document feeder. The plain paper releases and absorbs residue from the rollers and separator pad.

If the problem persists, or the automatic document feeder does not pick up the plain paper, you can clean the rollers and separator pad manually.

### To clean the rollers or separator pad

- 1 Lift the cover of the automatic document feeder.  
The rollers and separator pad are identified in the following illustration.

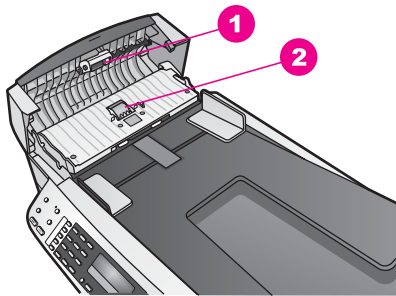

|   |               |
|---|---------------|
| 1 | Rollers       |
| 2 | Separator pad |

- 2 Lightly dampen a clean lint-free cloth with distilled water, then squeeze any excess liquid from the cloth.
- 3 Use the damp cloth to wipe any residue off the rollers or separator pad.
- 4 If the residue does not come off using distilled water, try using isopropyl (rubbing) alcohol.
- 5 Close the cover of the automatic document feeder.

### Print cartridge troubleshooting

If you are experiencing problems with printing, you might have a problem with one of the print cartridges.

- 1 Remove the print cartridges and check that the protective tape has been completely removed.
- 2 Reinsert the print cartridges and verify that they are fully inserted and locked in place.

- 3 If the problem persists, print a self-test report to determine if there is a problem with the print cartridges.  
This report provides useful information about your print cartridges, including status information.
- 4 If the self-test report shows a problem, clean the print cartridges.
- 5 If the problem persists, clean the copper-colored contacts of the print cartridges.
- 6 If you are still experiencing problems with printing, determine which print cartridge is experiencing the problem and replace it.

For more information on these topics, see [Maintain your HP all-in-one](#).

## HP Image Zone troubleshooting

If your HP all-in-one has been connected to a computer with a USB cable and you now want to connect it to a network using an HP JetDirect, you will only be able to print or scan (using Webscan) from your computer(s). If you try to use the **HP Image Zone** software, you will find that the scan picture, scan documents, send a fax, and make copies features display error messages indicating that the HP all-in-one is disconnected.

### I get an error message when I select Scan Picture

#### Solution

If you try to use the **HP Image Zone** software, you will find that the scan picture feature displays an error message indicating that the HP all-in-one is disconnected.

- Close out of the error message and use Webscan to perform a scan.  
For more information on Webscan, see [Use Webscan](#).

### I get an error message when I select Scan Document or Scan to OCR

#### Solution

If you try to use the **HP Image Zone** software, you will find that the scan document feature displays an error message indicating that the HP all-in-one is disconnected.

- Close out of the error message and use Webscan to perform a scan.  
For more information on Webscan, see [Use Webscan](#).

### I get an error message when I select Make Copies

#### Solution

If you try to use the **HP Image Zone** software, you will find that the make copies feature displays an error message indicating that the HP all-in-one is disconnected.

- Close out of the error message and use the control panel of your HP all-in-one to make a copy.  
For more information on making a copy from the control panel, see [Use the copy features](#).

### I get an error message when I select Send a Fax

## Solution

If you try to use the **HP Image Zone** software, you will find that the send a fax feature displays an error message indicating that the HP all-in-one is disconnected.

- Close out of the error message and use the control panel of your HP all-in-one to send a fax.

For more information on sending a fax from the control panel, see [Use the fax features](#).

## Device update

Several options are provided to update your HP all-in-one. Each involves downloading a file to your computer to start the **Device Update Wizard**. For example:

- Based on advice from HP customer support you might access the HP support website to retrieve an upgrade for your device.
- A dialog might appear on your HP all-in-one control panel display to direct you to update your device.

**Note** If you are a Windows user, you can set the **Software Update** utility (part of the **HP Image Zone** software installed on your computer) to automatically search the HP support website for device updates at predetermined intervals. For more information on the **Software Update** utility, see the onscreen **HP Image Zone Help**.

### Device update (Windows)

Use one of the following to retrieve an update for your device:

- Use your Web browser to download an update for your HP all-in-one from [www.hp.com/support](http://www.hp.com/support). The file will be a self-extracting executable with the extension .exe. When you double-click the .exe file, the **Device Update Wizard** opens on your computer.
- Use the **Software Update** utility to automatically search the HP support website for device updates at predetermined intervals.

**Note** After the **Software Update** utility is installed on your computer, it searches for device updates. If you do not have the latest version of the **Software Update** utility at the time of install, a dialog appears on your computer prompting you to upgrade. Accept the upgrade.

### To use device update

- 1 Do one of the following:
  - Double-click the update .exe file you downloaded from [www.hp.com/support](http://www.hp.com/support).
  - When prompted, accept the device update found by the **Software Update** utility.The **Device Update Wizard** opens on your computer.
- 2 At the **Welcome** screen, click **Next**.  
The **Select a Device** screen appears.
- 3 Select your HP all-in-one from the list, and then click **Next**.  
The **Important Information** screen appears.
- 4 Make sure your computer and device meet the requirements listed.

- 5 If you meet the requirements, click **Update**.  
The **Updating Device** screen appears. A light then begins to flash on the control panel of your HP all-in-one.  
The screen on your control panel display turns green as the update is loaded and extracted to your device.
- 6 Do not disconnect, shut down, or otherwise disturb your device while the update is occurring.

**Note** If you disrupt the update, or an error message indicates the update failed, call HP support for assistance.

After your HP all-in-one shuts down and restarts, an update complete screen appears on your computer

Your device is updated. It is now safe to use your HP all-in-one

### Device update (Macintosh)

The device update installer provides a means to apply updates to your HP all-in-one as follows:

- 1 Use your Web browser to download an update for your HP all-in-one from [www.hp.com/support](http://www.hp.com/support).
- 2 Double-click the downloaded file.  
The installer opens on your computer.
- 3 Follow the onscreen prompts to install the update to your HP all-in-one.
- 4 Restart the HP all-in-one to complete the process.

# 16 Get HP support

Hewlett-Packard provides Internet and phone support for your HP all-in-one.

This chapter provides information on how to get support from the Internet, contact HP customer support, access your serial number and service ID, call in North America during warranty, call HP Japan customer support, call HP Korea customer support, call elsewhere in the world, call Australia post-warranty, and prepare your HP all-in-one for shipment.

If you are unable to find the answer you need in the printed or onscreen documentation supplied with your product, you can contact one of the HP support services listed in the following pages. Some support services are available only in the U.S. and Canada, while others are available in many countries/regions worldwide. If a support service number is not listed for your country/region, contact your nearest authorized HP dealer for help.

## Get support and other information from the Internet

If you have Internet access, you can get help from the following HP website:

[www.hp.com/support](http://www.hp.com/support)

This website offers technical support, drivers, supplies, and ordering information.

## HP customer support

Software programs from other companies might be included with your HP all-in-one. If you experience problems with any of those programs, you will receive the best technical assistance by calling the experts at that company.

If you need to contact HP Customer Support, do the following before you call.

- 1 Make sure that:
  - a Your HP all-in-one is plugged in and turned on.
  - b The specified print cartridges are installed correctly.
  - c The recommended paper is properly loaded in the input tray.
- 2 Reset your HP all-in-one:
  - a Turn off the HP all-in-one by pressing the **On** button.
  - b Unplug the power cord from the back of the HP all-in-one.
  - c Plug the power cord back into the HP all-in-one.
  - d Turn on the HP all-in-one by pressing the **On** button.
- 3 For more information, go to [www.hp.com/support](http://www.hp.com/support).  
This website offers technical support, drivers, supplies, and ordering information.
- 4 If you are still experiencing problems and need to speak with an HP Customer Support Representative, do the following:
  - a Have the specific name of your HP all-in-one, as it appears on the control panel, available.
  - b Print a self-test report. For information on printing a self-test report, see [Print a self-test report](#).
  - c Make a color copy to have available as a sample printout.
  - d Be prepared to describe your problem in detail.
  - e Have your serial number and service ID ready. For information on how to access your serial number and service ID, see [Access your serial number and service ID](#).
- 5 Call HP Customer Support. Be near your HP all-in-one when you call.

## Access your serial number and service ID

You can access important information by using the **Information Menu** of your HP all-in-one.

**Note** If your HP all-in-one is not turning on, you can view the serial number by looking at the sticker on the rear side. The serial number is the 10-character code in the upper left corner of the sticker.

#### To access your serial number and service ID

- 1 Press and hold **OK**. While holding **OK**, press **4**. This displays the **Information Menu**.
- 2 Press **▶** until **Model Number** appears and then press **OK**. This displays the service ID. Write down the complete service ID.
- 3 Press **Cancel**, and then press **▶** until **Serial Number** appears.
- 4 Press **OK**. This displays the serial number. Write down the complete serial number.
- 5 Press **Cancel** to exit the **Information Menu**.

## Call in North America during warranty

Call **1-800-474-6836 (1-800-HP invent)**. US phone support is available in both English and Spanish languages 24 hours a day, 7 days a week (days and hours of support may change without notice). This service is free during the warranty period. A fee may apply outside the warranty period.

## Call elsewhere in the world

The numbers listed below are current as of the publication date of this guide. For a list of current international HP Support Service numbers, go to [www.hp.com/support](http://www.hp.com/support) and choose your own country/region or language.

You can call the HP support center in the following countries/regions. If your country/region is not listed, contact your local dealer or nearest HP Sales and Support Office to find out how to obtain services.

Support service is free during the warranty period; however, your standard long-distance phone charges will apply. In some cases, a flat fee per single incident will also apply.

For phone support in Europe, please check for the details and conditions of phone support in your country/region by going to [www.hp.com/support](http://www.hp.com/support).

Alternatively, you can ask your dealer or call HP at the phone number provided in this guide.

As part of our constant efforts to improve our phone support service, we advise you to check our website on a regular basis for new information regarding service features and delivery.

| Country/Region                            | HP technical support             | Country/Region       | HP technical support |
|---|----------------------------------|----------------------|----------------------|
| Algeria <sup>1</sup>                      | +213 61 56 45 43                 | Lebanon              | +971 4 883 8454      |
| Argentina                                 | (54)11-4778-8380, 0-810-555-5520 | Luxembourg (French)  | 900 40 006           |
| Australia during warranty                 | 131047                           | Luxembourg (German)  | 900 40 007           |
| Australia post-warranty (per-call charge) | 1902 910 910                     | Malaysia             | 1-800-805405         |
| Austria                                   | +43 1 86332 1000                 | Mexico               | 01-800-472-6684      |
| Bahrain                                   | 800 171                          | Mexico (Mexico City) | (55) 5258-9922       |
| Bangladesh                                | fax to: +65-6275-6707            | Middle East          | +971 4 366 2020      |
| Belgium (Dutch)                           | +32 070 300 005                  | Morocco <sup>1</sup> | +212 22 404747       |

(continued)

| Country/Region                         | HP technical support                     | Country/Region                     | HP technical support  |
|--|--|------------------------------------|-----------------------|
| Belgium (French)                       | +32 070 300 004                          | Netherlands (0.10 Euro/min.)       | 0900 2020 165         |
| Bolivia                                | 800-100247                               | New Zealand                        | 0800 441 147          |
| Brazil (Demais Localidades)            | 0800-157751                              | Nigeria                            | +234 1 3204 999       |
| Brazil (Grande São Paulo)              | (11) 3747-7799                           | Norway <sup>2</sup>                | +47 815 62 070        |
| Brunei                                 | fax to: +65-6275-6707                    | Oman                               | +971 4 883 8454       |
| Cambodia                               | fax to: +65-6275-6707                    | Pakistan                           | fax to: +65-6275-6707 |
| Canada during warranty                 | (905) 206 4663                           | Palestine                          | +971 4 883 8454       |
| Canada post-warranty (per-call charge) | 1-877-621-4722                           | Panama                             | 001-800-711-2884      |
| Caribbean & Central America            | 1-800-711-2884                           | Peru                               | 0-800-10111           |
| Chile                                  | 800-360-999                              | Philippines                        | 632-867-3551          |
| China, mainland                        | 86-21-38814518, 8008206616               | Poland                             | +48 22 5666 000       |
| Colombia                               | 01-800-51-474-6836 (01-800-51-HP invent) | Portugal                           | +351 808 201 492      |
| Costa Rica                             | 0-800-011-4114, 1-800-711-2884           | Puerto Rico                        | 1-877-232-0589        |
| Czech Republic                         | +420 261307310                           | Qatar                              | +971 4 883 8454       |
| Denmark                                | +45 70 202 845                           | Romania                            | +40 (21) 315 4442     |
| Dominican Republic                     | 1-800-711-2884                           | Russian Federation, Moscow         | +7 095 7973520        |
| Ecuador (Andinatel)                    | 999119+1-800-7112884                     | Russian Federation, St. Petersburg | +7 812 3467997        |
| Ecuador (Pacifitel)                    | 1-800-225528+1-800-7112884               | Saudi Arabia                       | 800 897 1444          |
| Egypt                                  | +20 2 532 5222                           | Singapore                          | 65 - 62725300         |
| English International                  | +44 (0) 207 512 5202                     | Slovakia                           | +421 2 50222444       |
| Finland                                | +358 (0) 203 66 767                      | South Africa (RSA)                 | 086 0001030           |
| France (0.34 Euro/min.)                | +33 (0)892 69 60 22                      | South Africa, Outside Republic     | +27 11 2589301        |
| Germany (0.12 Euro/min.)               | +49 (0) 180 5652 180                     | Spain                              | +34 902 010 059       |



| Country/Region                      | HP technical support | Country/Region           | HP technical support             |
|-------------------------------------|----------------------|--------------------------|----------------------------------|
| Greece (Cyprus to Athens toll free) | 800 9 2649           | Sri Lanka                | fax to: +65-6275-6707            |
| Greece, inside country/region       | 801 11 22 55 47      | Sweden                   | +46 (0)77 120 4765               |
| Greece, international               | +30 210 6073603      | Switzerland <sup>3</sup> | +41 0848 672 672                 |
| Guatemala                           | 1800-999-5105        | Taiwan                   | +886 (2) 8722-8000, 0800 010 055 |
| Hong Kong SAR                       | +(852) 2802 4098     | Thailand                 | 0-2353-9000                      |
| Hungary                             | +36 1 382 1111       | Trinidad & Tobago        | 1-800-711-2884                   |
| India                               | 91-80-8526900        | Tunisia <sup>1</sup>     | +216 71 89 12 22                 |
| India (toll free)                   | 1600-4477 37         | Turkey                   | +90 216 579 71 71                |
| Indonesia                           | 62-21-350-3408       | Ukraine, Kiev            | +7 (380 44) 4903520              |
| Ireland                             | +353 1890 923 902    | United Arab Emirates     | 800 4520                         |
| Israel                              | +972 (0) 9 830 4848  | United Kingdom           | +44 (0) 870 010 4320             |
| Italy                               | +39 848 800 871      | United States            | 1-800-474-6836 (1-800-HP invent) |
| Jamaica                             | 1-800-711-2884       | Venezuela                | 0-800-474-6836 (0-800-HP invent) |
| Japan                               | +81-3-3335-9800      | Venezuela (Caracas)      | (502) 207-8488                   |
| Jordan                              | +971 4 883 8454      | Vietnam                  | 84-8-823-4530                    |
| Korea                               | +82 1588 3003        | W. Africa                | +351 213 17 63 80                |
| Kuwait                              | +971 4 883 8454      | Yemen                    | +971 4 883 8454                  |

- 1 This Call Center supports French-speaking customers from the following countries/regions: Morocco, Tunisia, and Algeria.
- 2 Setup price per call: 0.55 Norway kroner (0.08 Euro), customer price per minute: 0.39 Norway kroner (0.05 Euro).
- 3 This Call Center supports German-, French-, and Italian-speaking customers in Switzerland (0.08 CHF/min. during peak hours, 0.04 CHF/min. during off-peak hours).

## Call in Australia post-warranty

If your product is not under warranty, call 131047. A per-incident, out-of-warranty support fee will be charged to your credit card.  
You can also call 1902 910 910. A per-incident, out-of-warranty support fee will be charged to your phone bill.

## Call HP Korea customer support

### HP 한국 고객 지원 문의

- \*고객 지원 센터 대표 전화  
1588-3003
- \*제품가격 및 구입처 정보 문의 전화  
080-703-0700
- \* 전화 상담 가능 시간 :  
평 일 09:00~18:00  
토요일 09:00~13:00  
(일요일,공휴일 제외)

## Call HP Japan customer support

### カスタマー・ケア・センター

TEL : 0570-000-511 (ナビダイヤル)

03-3335-9800 (ナビダイヤルをご利用いただけない場合)

FAX : 03-3335-8338

月~金 9:00 ~ 17:00

土・日 10:00 ~ 17:00 (祝祭日、1/1~3を除く)

FAXによるお問い合わせは、ご質問内容とともに、ご連絡先、  
弊社製品名、接続コンピュータ名をご記入ください。

## HP Quick Exchange Service (Japan)

製品に問題がある場合は以下に記載されている電話番号に連絡してください。製品が故障している、または欠陥があると判断された場合、**HP Quick Exchange Service**がこの製品を正常品と交換し、故障した製品を回収します。保証期間中は、修理代と送料は無料です。また、お住まいの地域にも依りますが、プリンタを次の日までに交換することも可能です。

電話番号：0570-000511（自動応答）

:03-3335-9800（自動応答システムが使用できない場合）

サポート時間：平日の午前 9:00 から午後 5:00 まで

土日の午前 10:00 から午後 5:00 まで。

祝祭日および1月1日から3日は除きます。

### サービスの条件

- サポートの提供は、カスタマケアセンターを通してのみ行われます。
- カスタマケアセンターがプリンタの不具合と判断した場合に、サービスを受けることができます。

**ご注意：** ユーザの扱いが不適切であったために故障した場合は、保証期間中であっても修理は有料となります。詳細については保証書を参照してください。

### その他の制限

- 運送の時間はお住まいの地域によって異なります。詳しくは、カスタマケアターに連絡してご確認ください。
- 出荷配送は、当社指定の配送業者が行います。
- 配送は交通事情などの諸事情によって、遅れる場合があります。
- このサービスは、将来予告なしに変更することがあります。

## Prepare your HP all-in-one for shipment

If after contacting HP Customer Support or returning to the point of purchase, you are requested to send your HP all-in-one in for service, remove the print cartridges and pack the HP all-in-one in the original packing materials to avoid further damage. You can remove print cartridges from your HP all-in-one whether it is turning on or not. Retain the power cord and control panel overlay in case the HP all-in-one needs to be replaced.

**Note** This information does not apply to customers in Japan. For information on service options in Japan, see [HP Quick Exchange Service \(Japan\)](#).

- 1 Turn on the HP all-in-one. If your HP all-in-one will not turn on, skip this step and go to step 2.
- 2 Open the print-carriage access door.
- 3 Wait until the print carriage is idle and silent, and then remove the print cartridges from their slots. For information on removing the print cartridges, see [Replace the print cartridges](#).

**Note** If your HP all-in-one does not turn on, you can unplug the power cord and then manually slide the print carriage to the far right to remove the print cartridges. When finished, manually move the print carriage to the home position (on the left side).

- 4 Place the print cartridges in print cartridge protectors or an airtight plastic container so they will not dry out, and put them aside. Do not send them with the HP all-in-one unless the HP customer support call agent instructs you to.
- 5 Close the print-carriage access door and wait a few minutes for the print carriage to move back to its home position (on the left side).

**Note** Make sure the scanner has returned to its parked position before turning off the HP all-in-one.

- 6 Press the **On** button to turn off the HP all-in-one.
- 7 Unplug the power cord, and then disconnect it from the HP all-in-one. Do not return the power cord with the HP all-in-one.

**Warning** The replacement HP all-in-one will not be shipped with a power cord. Store the power cord in a safe place until the replacement HP all-in-one arrives.

- 8 Remove the control panel overlay as follows:
  - a Place your hands on each side of the control panel overlay.
  - b Use your thumbs to pry the control panel overlay off.

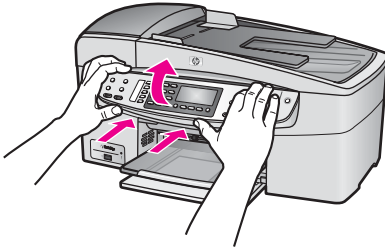

- 9 Retain the control panel overlay. Do not return the control panel overlay with the HP all-in-one.

**Warning** The replacement HP all-in-one might not come with a control panel overlay. Store your control panel overlay in a safe place, and when the replacement HP all-in-one arrives, reattach your control panel overlay. You must attach your control panel overlay to use the control panel functions on the replacement HP all-in-one.

**Note** See the Setup Guide that came with your HP all-in-one for instructions on how to attach your control panel overlay. The replacement HP all-in-one might come with instructions for setting up your device.

- 10 If available, pack the HP all-in-one for shipment by using the original packing materials or the packaging materials that came with your exchange device.

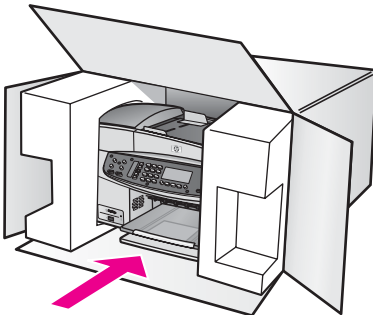

If you do not have the original packaging materials, please use other adequate packaging materials. Shipping damage caused by improper packaging and/or improper transportation is not covered under the warranty.

- 11 Place the return shipping label on the outside of the box.

- 12 Include the following items in the box:
- A complete description of symptoms for service personnel (samples of print quality problems are helpful).
  - A copy of the sales slip or other proof of purchase to establish the warranty coverage period.
  - Your name, address, and a phone number where you can be reached during the day.

# 17 Warranty information

Your HP all-in-one comes with a limited warranty that is described in this section. Information about how to obtain warranty service and how you can upgrade your standard factory warranty is also provided.

This chapter provides information on duration of your HP all-in-one limited warranty, warranty service, warranty upgrades, returning you HP all-in-one for service, and contains the Hewlett-Packard limited global warranty statement.

## Duration of limited warranty

Duration of Limited Warranty (hardware and labor): 1 Year

Duration of Limited Warranty (CD media): 90 Days

Duration of Limited Warranty (print cartridges): Until the HP ink is depleted or the "end of warranty" date printed on the cartridge has been reached, whichever occurs first. This warranty does not cover HP ink products that have been refilled, remanufactured, refurbished, misused, or tampered with.

## Warranty service

To obtain HP repair service, you must first contact an HP service office or an HP Customer Support Center for basic troubleshooting. See [HP customer support](#) for steps to take before calling Customer Support.

If your HP all-in-one needs a minor part replacement that you can replace, HP might prepay shipping charges, duty and taxes; provide telephone assistance for replacing the part; and pay shipping charges, duty, and taxes for any part that HP asks you to return. Otherwise, the HP Customer Support Center will direct you to an authorized service provider who is certified by HP to service the product.

**Note** This information does not apply to customers in Japan. For information on service options in Japan, see [HP Quick Exchange Service \(Japan\)](#).

## Warranty upgrades

Depending on your country/region, HP might offer a warranty upgrade option that extends or enhances your standard product warranty. Available options might include priority phone support, return service, or next business day exchange. Typically, service coverage begins on product purchase date and must be purchased within a limited time of product purchase.

For more information:

- In the U.S., dial 1-866-234-1377 to speak to an HP advisor.
- Outside the U.S., please call your local HP Customer Support office. See [Call elsewhere in the world](#) for a list of international Customer Support numbers.
- Go to [www.hp.com/support](http://www.hp.com/support).

If prompted, choose your country/region, and then find warranty information.

## Returning your HP all-in-one for service

Before returning your HP all-in-one for service, you must call HP Customer Support. See [HP customer support](#) for steps to take before calling Customer Support.

**Note** This information does not apply to customers in Japan. For information on service options in Japan, see [HP Quick Exchange Service \(Japan\)](#).

## Hewlett-Packard limited global warranty statement

The following information specifies the HP limited global warranty.

### Extent of limited warranty

Hewlett-Packard ("HP") warrants to the end-user customer ("Customer") that each HP Officejet 6200 series all-in-one product ("Product"), including related software, accessories, media, and supplies, shall be free from defects in material and workmanship for the duration, which begins on the date of purchase by the Customer.

For each hardware Product, the duration of HP's limited warranty is one year for parts and one year for labor. For all other Products, the duration of HP's limited warranty for both parts and labor is ninety days.

For each software Product, HP's limited warranty applies only to a failure to execute programming instructions. HP does not warrant that the operation of any Product shall be uninterrupted or error free.

HP's limited warranty covers only those defects which arise as a result of normal use of a Product, and does not cover any other problems, including those which arise as a result of (a) improper maintenance or modification, (b) software, accessories, media, or supplies not provided or supported by HP, or (c) operation outside the Product's specifications.

For any hardware Product, the use of a non-HP ink cartridge or a refilled ink cartridge does not affect either the warranty to the Customer or any HP support contract with the Customer.

However, if Product failure or damage is attributable to the use of a non-HP or refilled ink cartridge, HP shall charge its standard labor and materials charges to service the Product for the failure or damage.

If HP receives, during the applicable warranty period, notice of a defect in any Product, HP shall either repair or replace the defective Product, at HP's option. Where labor charges are not covered by HP's limited warranty, repairs shall be at HP's standard charges for labor.

If HP is unable to repair or replace, as applicable, a defective Product which is covered by HP's warranty, HP shall, within a reasonable time after being notified of the defect, refund the purchase price for the Product.

HP shall have no obligation to repair, replace, or refund until the Customer returns the defective Product to HP.

Any replacement product may be either new or like-new, provided that it has functionality at least equal to that of the Product being replaced.

HP products, including each Product, may contain remanufactured parts, components, or materials equivalent to new in performance.

HP's limited warranty for each Product is valid in any country/region or locality where the covered HP product is distributed by HP. Contracts for additional warranty service, such as on-site service, are available from any authorized HP service facility in countries/regions where the product is distributed by HP or by an authorized representative.

### Limitations of warranty

TO THE EXTENT ALLOWED BY LOCAL LAW, NEITHER HP NOR ITS THIRD PARTY SUPPLIERS MAKE ANY OTHER WARRANTY OR CONDITION OF ANY KIND, WHETHER EXPRESS OR IMPLIED, WARRANTIES OR CONDITIONS OF MERCHANTABILITY, SATISFACTORY QUALITY, AND FITNESS FOR A PARTICULAR PURPOSE.

### Limitations of liability

To the extent allowed by local law, the remedies provided in this Limited Warranty Statement are the Customer's sole and exclusive remedies.

TO THE EXTENT ALLOWED BY LOCAL LAW, EXCEPT FOR THE OBLIGATIONS SPECIFICALLY SET FORTH IN THIS LIMITED WARRANTY STATEMENT, IN NO EVENT SHALL HP OR ITS THIRD PARTY SUPPLIERS BE LIABLE FOR DIRECT, INDIRECT, SPECIAL, INCIDENTAL, OR CONSEQUENTIAL DAMAGES, WHETHER BASED ON CONTRACT, TORT,

OR ANY OTHER LEGAL THEORY AND WHETHER ADVISED OF THE POSSIBILITY OF SUCH DAMAGES.

### Local law

This Limited Warranty Statement gives the Customer specific legal rights. The Customer may also have other rights which vary from state to state in the United States, from province to province in Canada, and from country/region to country/region elsewhere in the world.

To the extent this Limited Warranty Statement is inconsistent with local law, this Statement shall be deemed modified to be consistent with such local law. Under such local law, certain disclaimers and limitations of this Statement may not apply to the Customer. For example, some states in the United States, as well as some governments outside the United States (including provinces in Canada), may:

Preclude the disclaimers and limitations in this Statement from limiting the statutory rights of a consumer (for example, the United Kingdom);

Otherwise restrict the ability of a manufacturer to enforce such disclaimers or limitations; or

Grant the Customer additional warranty rights, specify the duration of implied warranties which the manufacturer cannot disclaim, or not allow limitations on the duration of implied warranties.

FOR CONSUMER TRANSACTIONS IN AUSTRALIA AND NEW ZEALAND, THE TERMS IN THIS LIMITED WARRANTY STATEMENT, EXCEPT TO THE EXTENT LAWFULLY PERMITTED, DO NOT EXCLUDE, RESTRICT, OR MODIFY, AND ARE IN ADDITION TO, THE MANDATORY STATUTORY RIGHTS APPLICABLE TO THE SALE OF THE COVERED HP PRODUCTS TO SUCH CUSTOMERS.

### Limited warranty information for EU countries/regions

Listed below are the names and addresses of the HP entities which grant HP's Limited Warranty (manufacturer's warranty) in EU countries/regions.

**You may also have statutory legal rights against the seller on the basis of the purchase agreement in addition to the manufacturer's warranty, which are not restricted by this manufacturer's warranty.**

|  |  |
|--|--|
| Belgique/Luxembourg<br>Hewlett-Packard Belgium SA/NV<br>Woluwedal 100<br>Boulevard de la Woluwe<br>B-1200 Brussels | Ireland<br>Hewlett-Packard Ireland Ltd.<br>30 Herbert Street<br>IRL-Dublin 2   |
| Danmark<br>Hewlett-Packard A/S<br>Kongevejen 25<br>DK-3460 Birkerød  | Nederland<br>Hewlett-Packard Nederland BV<br>Startbaan 16<br>1187 XR Amstelveen NL   |
| France<br>Hewlett-Packard France<br>1 Avenue du Canada<br>Zone d'Activite de Courtaboeuf<br>F-91947 Les Ulis Cedex | Portugal<br>Hewlett-Packard Portugal - Sistemas de<br>Informática e de Medida S.A.<br>Edificio D. Sancho I<br>Quinta da Fonte<br>Porto Salvo<br>2780-730 Paco de Arcos<br>P-Oeiras |



(continued)

|  |   |
|--|---|
| <p>Deutschland<br/>Hewlett-Packard GmbH<br/>Herrenberger Straße 110-140<br/>D-71034 Böblingen</p>                        | <p>Österreich<br/>Hewlett-Packard Ges.m.b.H.<br/>Lieblgasse 1<br/>A-1222 Wien</p>               |
| <p>España<br/>Hewlett-Packard Española S.A.<br/>Carretera Nacional VI<br/>km 16.500<br/>28230 Las Rozas<br/>E-Madrid</p> | <p>Suomi<br/>Hewlett-Packard Oy<br/>Piispankalliontie 17<br/>FIN-02200 Espoo</p>                |
| <p>Greece<br/>Hewlett-Packard Hellas<br/>265, Mesogion Avenue<br/>15451 N. Psychiko Athens</p>                           | <p>Sverige<br/>Hewlett-Packard Sverige AB<br/>Skalholtsgatan<br/>9S-164 97 Kista</p>            |
| <p>Italia<br/>Hewlett-Packard Italiana S.p.A<br/>Via G. Di Vittorio 9<br/>20063 Cernusco sul Naviglio<br/>I-Milano</p>   | <p>United Kingdom<br/>Hewlett-Packard Ltd<br/>Cain Road<br/>Bracknell<br/>GB-Berks RG12 1HN</p> |

# 18 Technical information

The technical specifications and international regulatory information for your HP all-in-one are provided in this section.

## System requirements

Software system requirements are located in the Readme file. For information on viewing the Readme file, see [View the Readme file](#).

## Paper specifications

This section contains information about paper-tray capacities, paper sizes, and print margin specifications.

### Paper-tray capacities

| Type                       | Paper weight                | Input tray <sup>1</sup> | Output tray <sup>2</sup> |
|----------------------------|-----------------------------|-------------------------|--------------------------|
| Plain paper                | 16 to 24 lb. (60 to 90 gsm) | 100 (20 lb. paper)      | 50 (20 lb. paper)        |
| Legal paper                | 20 to 24 lb. (75 to 90 gsm) | 100 (20 lb. paper)      | 50 (20 lb. paper)        |
| Cards                      | 110 lb. index max (200 gsm) | 20                      | 10                       |
| Envelopes                  | 20 to 24 lb. (75 to 90 gsm) | 10                      | 10                       |
| Transparency film          | N/A                         | 30                      | 15                       |
| Labels                     | N/A                         | 20                      | 10                       |
| 4 by 6 inch photo paper    | 145 lb. (236 gsm)           | 30                      | 15                       |
| 8.5 by 11 inch photo paper | N/A                         | 30                      | 15                       |

1 Maximum capacity.

2 Output tray capacity is affected by the type of paper and the amount of ink you are using. HP recommends emptying the output tray frequently.

**Note** The document feeder tray holds 20 sheets of Letter, Legal, and A4 sized paper (16 to 24 lb. paper).

### Paper sizes

| Type  | Size   |
|-------|--|
| Paper | Letter: 216 by 280 mm (8.5 by 11 inches)<br>A4: 210 by 297 mm<br>A5: 148 by 210 mm<br>Executive: 184.2 by 266.7 mm (7.25 by 10.5 inches) |

(continued)

| Type              | Size  |
|-------------------|---|
|                   | Legal: 216 by 356 mm (8.5 by 14 inches)   |
| Envelopes         | U.S. #10: 105 by 241 mm (4.125 by 9.5 inches)<br>U.S. #9: 98 by 225 mm (3.9 by 8.9 inches)<br>A2: 111 by 146 mm (4.4 by 5.8 inches)<br>DL: 110 by 220 mm (4.3 by 8.7 inches)<br>C6: 114 by 162 mm (4.5 by 6.4 inches) |
| Transparency film | Letter: 216 by 279 mm (8.5 by 11 inches)<br>A4: 210 by 297 mm   |
| Photo paper       | 102 by 152 mm (4 by 6 inches)<br>10 by 15 cm<br>127 by 178 mm (5 by 7 inches)<br>Letter: 216 by 280 mm (8.5 by 11 inches)<br>A4: 210 by 297 mm  |
| Cards             | 76 by 127 mm (3 by 5 inches)<br>Index card: 101 by 152 mm (4 by 6 inches)<br>127 by 178 mm (5 by 7 inches)<br>A6: 105 by 148.5 mm<br>Hagaki postcard: 100 by 148 mm (3.94 by 5.83 inches)                             |
| Labels            | Letter: 216 by 279 mm (8.5 by 11 inches)<br>A4: 210 by 297 mm   |
| Custom            | 76 by 127 mm up to 216 by 356 mm (3 by 5 inches up to 8.5 by 14 inches)   |

### Print margin specifications

|                                 | Top (leading edge)   | Bottom (trailing edge) <sup>1</sup> | Left and Right margins |
|---------------------------------|----------------------|-------------------------------------|------------------------|
| U.S. (Letter, Legal, Executive) | 1.8 mm (0.07 inches) | 6.7 mm (0.3 inches)                 | 1.5 mm (0.06 inches)   |
| ISO (A4, A5) and JIS (B5)       | 1.8 mm (0.07 inches) | 6.7 mm (0.3 inches)                 | 1.5 mm (0.06 inches)   |
| Envelopes                       | 1.8 mm (0.07 inches) | 6.7 mm (0.3 inches)                 | 1.5 mm (0.06 inches)   |
| Cards                           | 1.8 mm (0.07 inches) | 6.7 mm (0.3 inches)                 | 1.5 mm (0.06 inches)   |

<sup>1</sup> This margin is not compatible; however, the total writing area is compatible. The writing area is offset from center by 5.4 mm (0.21 inches), which causes asymmetric top and bottom margins.

### Print specifications

- 1200 by 1200 dpi black
- 4800 dpi Optimized dpi color, 4800 dpi 6 ink

- Method: drop-on-demand thermal inkjet
- Language: HP PCL Level 3, PCL3 GUI or PCL 10
- Up to 23 copies per minute black; 18 copies per minute color (varies by model)
- Print speeds vary according to the complexity of the document

| Mode        | Resolution (dpi)   |
|-------------|--|
| Maximum dpi | up to 4800 by 1200 optimized dpi using 1200 rendered dpi |
| Best        | up to 1200 by 1200                                       |
| Normal      | up to 600 by 600   |
| Fast Draft  | up to 300 by 300   |

## Copy specifications

- Digital image processing
- Up to 99 copies from original (varies by model)
- Digital zoom from 25 to 400% (varies by model)
- Fit to page, pre-scan
- Up to 23 copies per minute black; 18 copies per minute color (varies by model)
- Copy speeds vary according to the complexity of the document

| Mode   | Print resolution (dpi)                               | Scan resolution (dpi) <sup>1</sup> |
|--------|--|------------------------------------|
| Best   | up to 4800 by 1200 optimized dpi using 1200 scan dpi | up to 1200 by 1200                 |
| Normal | up to 600 by 600                                     | up to 300 by 300                   |
| Fast   | up to 300 by 300                                     | up to 300 by 300                   |

1 Maximum at 400% scaling.

## Fax specifications

- Walk-up black and white and color fax capability
- Up to 100 speed dials (varies by model)
- Up to 100-page memory (varies by model, based on ITU-T Test Image #1 at standard resolution). More complicated pages or higher resolution will take longer and use more memory.
- Manual multiple-page fax
- Automatic busy redial up to five times (varies by model)
- Automatic no-answer redial one time (varies by model)
- Confirmation and activity reports
- CCITT/ITU Group 3 fax with Error Correction Mode
- 33.6 Kbps transmission
- 3 seconds per page speed at 33.6 Kbps (based on ITU-T Test Image #1 at standard resolution). More complicated pages or higher resolution take longer and use more memory
- Ring detect with automatic fax/answering machine switching

|       | Photo (dpi)                  | Very Fine (dpi) | Fine (dpi) | Standard (dpi) |
|-------|------------------------------|-----------------|------------|----------------|
| Black | 196 by 196 (8-bit grayscale) | 300 by 300      | 196 by 196 | 98 by 98       |
| Color | 200 by 200                   | 200 by 200      | 200 by 200 | 200 by 200     |

(continued)

|  | Photo (dpi) | Very Fine (dpi) | Fine (dpi) | Standard (dpi) |
|--|-------------|-----------------|------------|----------------|
|--|-------------|-----------------|------------|----------------|

## Scan specifications

- Image editor included
- Integrated OCR software automatically converts scanned text to editable text
- Scan speeds vary according to the complexity of the document
- Twain-compliant interface
- Resolution: 1200 by 2400 ppi optical, up to 19,200 dpi enhanced
- Color: 16-bit per RGB color, 48-bit total
- Maximum scan size from glass: 216 by 297 mm (8.5 by 11.7 inches)

## Physical specifications

- Height: 23.4 cm (9.1 inches)
- Width: 45 cm (17.6 inches)
- Depth: 38.4 cm (15 inches)
- Weight: 6.8 kg (15 pounds)

## Power specifications

- Power consumption: 60 W maximum
- Input voltage: AC 100 to 240 V ~ 1630 mA 50–60 Hz, grounded
- Output voltage: DC 32Vdc===1100 mA, 16V dc===1600 mA

## Environmental specifications

- Recommended operating temperature range: 15° to 32° C (59° to 90° F)
- Allowable operating temperature range: -15° to 35° C (5° to 104° F)
- Humidity: 15% to 85% RH non-condensing
- Non-operating (Storage) temperature range: -4° to 60° C (-40° to 140° F)
- In the presence of high electromagnetic fields it is possible the output from the HP all-in-one may be slightly distorted
- HP recommends using a USB cable less than or equal to 3 m (10 feet) in length to minimize injected noise due to potential high electromagnetic fields

## Additional specifications

If you have Internet access, you can get acoustic information from the HP website. Go to [www.hp.com/support](http://www.hp.com/support).

## Environmental product stewardship program

This section provides information on protecting the environment; ozone production; energy consumption; paper use; plastics; material safety data sheets; and recycling programs.

This section contains information about environmental standards.

### Protecting the environment

Hewlett-Packard is committed to providing quality products in an environmentally sound manner. This product has been designed with several attributes to minimize impacts on our environment. For more information, visit HP's Commitment to the Environment website at: [www.hp.com/hpinfo/globalcitizenship/environment/index.html](http://www.hp.com/hpinfo/globalcitizenship/environment/index.html)

### Ozone production

This product generates no appreciable ozone gas (O<sub>3</sub>).

## Energy consumption

Energy usage drops significantly while in ENERGY STAR® mode, which saves natural resources, and saves money without affecting the high performance of this product. This product qualifies for ENERGY STAR, which is a voluntary program established to encourage the development of energy-efficient office products.



ENERGY STAR is a U.S. registered service mark of the U.S. EPA. As an ENERGY STAR partner, HP has determined that this product meets ENERGY STAR guidelines for energy efficiency.

For more information on ENERGY STAR guidelines, go to the following website:

[www.energystar.gov](http://www.energystar.gov)

## Paper use

This product is suited for the use of recycled paper according to DIN 19309.

## Plastics

Plastic parts over 25 grams are marked according to international standards that enhance the ability to identify plastics for recycling purposes at the end of the product's life.

## Material safety data sheets

Material safety data sheets (MSDS) can be obtained from the HP website at:

[www.hp.com/go/msds](http://www.hp.com/go/msds)

Customers without Internet access should contact their local HP Customer Care Center.

## Recycling program

HP offers an increasing number of product return and recycling programs in many countries, as well as partnering with some of the largest electronic recycling centers throughout the world. HP also conserves resources by refurbishing and reselling some of its most popular products.

This HP product contains the following materials that may require special handling at end-of-life:

- Mercury in the fluorescent lamp in the scanner (< 2 mg)
- Lead in the solder

## HP inkjet supplies recycling program

HP is committed to protecting the environment. The HP Inkjet Supplies Recycling Program is available in many countries/regions, and lets you recycle used print cartridges free of charge. For more information, go to the following website:

[www.hp.com/hpinfo/globalcitizenship/environment/recycle/inkjet.html](http://www.hp.com/hpinfo/globalcitizenship/environment/recycle/inkjet.html)

## Regulatory notices

The HP all-in-one meets product requirements from regulatory agencies in your country/region.

This section contains regulatory topics that do not pertain to wireless functions.

## Regulatory model identification number

For regulatory identification purposes, your product is assigned a Regulatory Model Number. The Regulatory Model Number for your product is SDGOB-0402. This regulatory number should not be confused with the marketing name (HP Officejet 6200 series all-in-one) or product number (Q5800A).

## Notice to users of the U.S. telephone network: FCC requirements

This equipment complies with FCC rules, Part 68. On this equipment is a label that contains, among other information, the FCC Registration Number and Ringer Equivalent Number (REN) for this equipment. If requested, provide this information to your telephone company.

An FCC compliant telephone cord and modular plug is provided with this equipment. This equipment is designed to be connected to the telephone network or premises wiring using a compatible modular jack which is Part 68 compliant. This equipment connects to the telephone network through the following standard network interface jack: USOC RJ-11C.

The REN is useful to determine the quantity of devices you may connect to your telephone line and still have all of those devices ring when your number is called. Too many devices on one line may result in failure to ring in response to an incoming call. In most, but not all, areas the sum of the RENs of all devices should not exceed five (5). To be certain of the number of devices you may connect to your line, as determined by the REN, you should call your local telephone company to determine the maximum REN for your calling area.

If this equipment causes harm to the telephone network, your telephone company may discontinue your service temporarily. If possible, they will notify you in advance. If advance notice is not practical, you will be notified as soon as possible. You will also be advised of your right to file a complaint with the FCC. Your telephone company may make changes in its facilities, equipment, operations, or procedures that could affect the proper operation of your equipment. If they do, you will be given advance notice so you will have the opportunity to maintain uninterrupted service.

If you experience trouble with this equipment, please contact the manufacturer, or look elsewhere in this manual, for warranty or repair information. Your telephone company may ask you to disconnect this equipment from the network until the problem has been corrected or until you are sure that the equipment is not malfunctioning.

This equipment may not be used on coin service provided by the telephone company. Connection to party lines is subject to state tariffs. Contact your state public utility commission, public service commission, or corporation commission for more information.

This equipment includes automatic dialing capability. When programming and/or making test calls to emergency numbers:

- Remain on the line and explain to the dispatcher the reason for the call.
- Perform such activities in the off-peak hours, such as early morning or late evening.

**Note** The FCC hearing aid compatibility rules for telephones are not applicable to this equipment.

The Telephone Consumer Protection Act of 1991 makes it unlawful for any person to use a computer or other electronic device, including fax machines, to send any message unless such message clearly contains in a margin at the top or bottom of each transmitted page or on the first page of transmission, the date and time it is sent and an identification of the business, other entity, or other individual sending the message and the telephone number of the sending machine or such business, other entity, or individual. (The telephone number provided may not be a 900 number or any other number for which charges exceed local or long-distance transmission charges.) In order to program this information into your fax machine, you should complete the steps described in the software.

## FCC statement

The United States Federal Communications Commission (in 47 CFR 15.105) has specified that the following notice be brought to the attention of users of this product.

**Declaration of Conformity:** This equipment has been tested and found to comply with the limits for a Class B digital device, pursuant to part 15 of the FCC Rules. Operation is subject to the following two conditions: (1) this device may not cause harmful interference, and (2) this device must accept any interference received, including interference that may cause undesired operation. Class B limits are designed to provide reasonable protection against harmful interference in a residential installation. This equipment generates, uses, and can radiate radio frequency energy, and, if not installed and used in accordance with the instructions, may cause harmful interference to radio

communications. However, there is no guarantee that interference will not occur in a particular installation. If this equipment does cause harmful interference to radio or television reception, which can be determined by turning the equipment off and on, the user is encouraged to try to correct the interference by one or more of the following measures:

- Reorient the receiving antenna.
- Increase the separation between the equipment and the receiver.
- Connect the equipment into an outlet on a circuit different from that to which the receiver is connected.
- Consult the dealer or an experienced radio/TV technician for help.

For more information, contact the Product Regulations Manager, Hewlett-Packard Company, San Diego, (858) 655-4100.

The user may find the following booklet prepared by the Federal Communications Commission helpful: How to Identify and Resolve Radio-TV Interference Problems. This booklet is available from the U.S. Government Printing Office, Washington DC, 20402. Stock No. 004-000-00345-4.



**Caution** Pursuant to Part 15.21 of the FCC Rules, any changes or modifications to this equipment not expressly approved by the Hewlett-Packard Company may cause harmful interference and void the FCC authorization to operate this equipment.

### Exposure to radio frequency radiation



**Caution** The radiated output power of this device is far below the FCC radio frequency exposure limits. Nevertheless, the device shall be used in such a manner that the potential for human contact during normal operation is minimized. This product and any attached external antenna, if supported, shall be placed in such a manner to minimize the potential for human contact during normal operation. In order to avoid the possibility of exceeding the FCC radio frequency exposure limits, human proximity to the antenna shall not be less than 20 cm (8 inches) during normal operation.

### Note à l'attention des utilisateurs du réseau téléphonique Canadien/ notice to users of the Canadian telephone network

Cet appareil est conforme aux spécifications techniques des équipements terminaux d'Industrie Canada. Le numéro d'enregistrement atteste de la conformité de l'appareil. L'abréviation IC qui précède le numéro d'enregistrement indique que l'enregistrement a été effectué dans le cadre d'une Déclaration de conformité stipulant que les spécifications techniques d'Industrie Canada ont été respectées. Néanmoins, cette abréviation ne signifie en aucun cas que l'appareil a été validé par Industrie Canada.

Pour leur propre sécurité, les utilisateurs doivent s'assurer que les prises électriques reliées à la terre de la source d'alimentation, des lignes téléphoniques et du circuit métallique d'alimentation en eau sont, le cas échéant, branchées les unes aux autres. Cette précaution est particulièrement importante dans les zones rurales.

Le numéro REN (Ringer Equivalence Number) attribué à chaque appareil terminal fournit une indication sur le nombre maximal de terminaux qui peuvent être connectés à une interface téléphonique. La terminaison d'une interface peut se composer de n'importe quelle combinaison d'appareils, à condition que le total des numéros REN ne dépasse pas 5.

Basé sur les résultats de tests FCC Partie 68, le numéro REN de ce produit est 0.2B.

This equipment meets the applicable Industry Canada Terminal Equipment Technical Specifications. This is confirmed by the registration number. The abbreviation IC before the registration number signifies that registration was performed based on a Declaration of Conformity indicating that Industry Canada technical specifications were met. It does not imply that Industry Canada approved the equipment.

Users should ensure for their own protection that the electrical ground connections of the power utility, telephone lines and internal metallic water pipe system, if present, are connected together. This precaution may be particularly important in rural areas.



**Note** The Ringer Equivalence Number (REN) assigned to each terminal device provides an indication of the maximum number of terminals allowed to be connected to a telephone interface. The termination on an interface may consist of any combination of devices subject only to the requirement that the sum of the Ringer Equivalence Numbers of all the devices does not exceed 5.

The REN for this product is 0.2B, based on FCC Part 68 test results.

### Notice to users in the European Economic Area



This product is designed to be connected to the analog Switched Telecommunication Networks (PSTN) of the European Economic Area (EEA) countries/regions.

Network compatibility depends on customer selected settings, which must be reset to use the equipment on a telephone network in a country/region other than where the product was purchased. Contact the vendor or Hewlett-Packard Company if additional product support is necessary.

This equipment has been certified by the manufacturer in accordance with Directive 1999/5/EC (annex II) for Pan-European single-terminal connection to the public switched telephone network (PSTN). However, due to differences between the individual PSTNs provided in different countries, the approval does not, of itself, give an unconditional assurance of successful operation on every PSTN network termination point.

In the event of problems, you should contact your equipment supplier in the first instance.

This equipment is designed for DTMF tone dialing and loop disconnect dialing. In the unlikely event of problems with loop disconnect dialing, it is recommended to use this equipment only with the DTMF tone dial setting.

### Notice to users of the German telephone network

This HP fax product is designed to connect only to the analogue public-switched telephone network (PSTN). Please connect the TAE N telephone connector plug, provided with the HP all-in-one into the wall socket (TAE 6) code N. This HP fax product can be used as a single device and/or in combination (in serial connection) with other approved terminal equipment.

### Geräuschemission

LpA < 70 dB am Arbeitsplatz im Normalbetrieb nach DIN 45635 T. 19

### Notice to users in Japan (VCCI-2)

この装置は、情報処理装置等電波障害自主規制協議会（VCCI）の基準に基づくクラスB情報技術装置です。この装置は、家庭環境で使用することを目的としていますが、この装置がラジオやテレビジョン受信機に近接して使用されると受信障害を引き起こすことがあります。  
取り扱い説明書に従って正しい取り扱いをして下さい。

## Notice to users in Korea

### 사용자 안내문(B급 기기)

이 기기는 비업무용으로 전자파 적합 등록을 받은 기기로서, 주거지역에서는 물론 모든 지역에서 사용할 수 있습니다.

## Declaration of conformity

This section contains the HP Officejet 6200 series all-in-one Declaration of conformity, and information about it for the European Economic Area.

### Declaration of conformity (European Economic Area)

The Declaration of Conformity in this document complies with ISO/IEC Guide 22 and EN 45014. It identifies the product, manufacturer's name and address, and applicable specifications recognized in the European community.

## HP Officejet 6200 series all-in-one Declaration of conformity

**DECLARATION OF CONFORMITY**

according to ISO/IEC Guide 22 and EN 45014

**Manufacturer's Name:** Hewlett-Packard Company**Manufacturer's Address:** 16399 West Bernardo Drive  
San Diego CA 92127, USA**declares, that the product****Regulatory Model Number:**SDGOB-0402**Product Name:**

OfficeJet 6200 Series (Q5800A, Q5802A, Q5810A)

**Model Number(s):**OJ 6210 (Q5801A/B), OJ 6213 (Q5808C), OJ 6210xi (Q5802A), OJ 6210v (Q5803A), OJ 6200 (Q5804A/B), OJ 6203 (Q5807A), OJ 6205 (Q5805A), OJ 6215 (Q5806B)  
OJ 6210 (Q5801A/C), OJ 6200 (Q5804A), OJ 6208 (Q5809D)**Power Adapter(s) HP part#:** 0950-4491 (international)**conforms to the following Product Specifications:**

Safety: IEC 60950-1: 2001  
EN 60950-1: 2002  
IEC 60825-1 Edition 1.2: 2001 / EN 60825-1+A11+A2+A1: 2002 Class 1(Laser/Led)  
UL 60950-1: 2003  
CAN/CSA-22.2 No. 60950-1-03  
NOM 019-SFCI-1993, AS/NZS 60950: 2000, GB4943: 2001

EMC: CISPR 22:1997 / EN 55022:1998 Class B  
CISPR 24:1997 / EN 55024:1998  
IEC 61000-3-2: 2000 / EN 61000-3-2: 2000  
IEC 61000-3-3/A1: 2001 / EN 61000-3-3/ A1: 2001  
CNS13438:1998, VCCI-2  
FCC Part 15-Class B/ICES-003, Issue 2  
GB9254: 1998

Telecom: TBR 21:1998, AS/ACIF S002:2001, FCC Part 68

**Supplementary Information:**

The product herewith complies with the requirements of the Low Voltage Directive 73/23/EC, the EMC Directive 89/336/EC and with the R&TTE Directive 1999/5/EC (Annex II) and carries the CE-marking accordingly. The product was tested in a typical configuration.

16 April 2004

Date

Steve Smith, Hardware Test &amp; Regs MGR.

European Contact for regulatory topics only: Hewlett Packard GmbH, HQ-TRE, Herrenberger Strasse 140,  
D-71034 Böblingen Germany, (FAX +49-7031-14-3143)

# Index

## Symbols/Numerics

- 10 by 15 cm photo paper
  - copy 35
  - load 29
  - specifications 159
- 2-wire phone cord 134, 140
- 4 by 6 inch photo paper
  - copy 35
- 4 by 6 inch photo paper, load 29
- 4-wire phone cord 134, 140

## A

- A4 paper, load 27
- ADSL line. *see* DSL line
- align print cartridges 114
- answer mode 77
- answer ring pattern 57, 92
- answering machine
  - receive faxes 77
  - setup 65, 67
  - troubleshoot 137, 139
- attention light 6
- auto answer 7, 77
- automatic document feeder
  - clean 142
  - feeding problems, troubleshoot 142
  - jams, troubleshoot 142
  - load original 25
- automatic fax reports 86

## B

- baud rate 94
- best copy quality 37
- blocked carriage 125
- borderless copies
  - 10 by 15 cm (4 by 6 inch) photo 39
  - fill entire page 39

## C

- cancel
  - copy 44
  - fax 82, 92, 96
  - print job 49

- scan 46
- cancel button 6
- carriage, blocked 125
- cartridges. *see* print cartridges
- clean
  - automatic document feeder 142
  - exterior 107
  - glass 105
  - lid backing 107
  - print cartridge contacts 115
  - print cartridge ink nozzle area 116
  - print cartridges 115
- color
  - copies 43
  - intensity 42
- computer modem. *see* PC modem
- confirmation reports, fax 86
- connection problems, fax 134, 136
- connection types supported
  - networked 18
  - printer sharing 18
  - USB 18
- contrast, fax 90
- control panel
  - enter text 85
  - overview 6
- control panel display
  - change language 122
  - change measurements 122
- copy
  - black-and-white documents 38
  - borderless photo 39
  - cancel 44
  - color intensity 42
  - copy specifications 161
  - default settings 37
  - enhance light areas 43
  - enlarge 41
  - iron-on transfers 43
  - legal to letter 41

- menu 7
  - menu button 7
  - number of copies 38
  - paper size 35
  - paper types, recommended 36
  - photos onto letter or A4 paper 39
  - photos, enhance 42
  - quality 37
  - reduce 41
  - size, custom 41
  - speed 37
  - text, enhance 42
  - correct port test, fax 132
  - customer support
    - Australia 150
    - contact 147
    - HP Quick Exchange Service (Japan) 152
    - Japan 151
    - Korea 151
    - North America 148
    - outside U.S. 148
    - serial number 147
    - service ID 147
    - warranty 155
    - website 147
- ## D
- darken
    - copies 42
    - faxes 90
  - date, set 84
  - declaration of conformity
    - European Economic Area 167
    - United States 168
  - default settings
    - fax 90
    - restore 118
  - device update
    - about 145
    - Macintosh 146
    - Windows 145
  - dial tone test, failure 133
  - distinctive ringing 57, 77, 92

DSL line, set up with fax 56

## E

enter text 85

envelopes

load 30

specifications 159

environment

Environmental product

stewardship program 162

inkjet supplies

recycling 163

environmental

specifications 162

error correction mode

(ECM) 94

error reports, fax 86

## F

factory defaults, restore 118

fast copy quality 37

fax

answer call 83

answer mode, set 77, 79

answer ring pattern 92

answering

machine 65, 67, 137, 139

auto answer, set 79

backup fax reception 93

cancel 96

contrast 90

date and time 84

defaults 90

delete 95

distinctive

ringing 57, 77, 92

DSL line, set up 56

enter text and symbols 85

error correction mode

(ECM) 94

fax specifications 161

forward faxes 91, 92

header 85

Internet, over 95, 140

ISDN line, set up 56

lighten or darken 90

manual receive 83

manual send 80

manual troubleshoot 136

menu 8

menu button 6

monitor dialing 82

paper size 90

pause 85

PBX system, set up 56

PC modem, set

up 61, 62, 67, 71

phone cord 131, 134, 140

poll to receive 84

receive 83, 134

redial 81, 92

reduce automatically 93

reports 74, 80, 86

reprint 95

resolution 89

rings to answer 83

schedule 81

send 79, 134

set up 51, 130

settings 89, 90

speed 94

speed dial 87, 88, 89

static on the phone

line 139

test 74, 130

test failed 131

tone or pulse dial 91

troubleshoot 130

voice mail, set up 60, 71

volume 91

FCC requirements 164

FCC statement 164

fill entire page photo

enlargement 39

fit to page 40

FoIP 95, 140

forward faxes 91, 92

four-wire phone cord 134, 140

front panel

scroll speed 118

## G

glass

clean 105

load original 25

greeting cards, load 31

group speed dial entries 88

## H

Hagaki cards, load 30

hardware test, fax 131

header, fax 85

HP All-in-One

return 155

HP all-in-one

about 5

ship your HP All-in-One 152

HP Director

HP Instant Share 101

missing icons 127

start 9

HP Gallery

OS 9 HP Image Zone 14

OS X HP Image Zone 12

HP help (OS 9 HP Image Zone) 14

HP Image Print (OS X HP Image Zone) 12

HP Image Zone

HP Instant Share 99, 100

Macintosh 10, 12, 100

overview 9

troubleshoot 144

Windows 9, 10, 99

HP Instant Share

about 97

e-mail photos from the

HP Image Zone (USB) 99

HP Image Zone 99

send images from HP image

Zone (USB) 99

send scanned images 98

send to a device 99

setup (USB) 97

HP JetDirect 17, 18

HP on the Web (OS 9 HP Image Zone) 14

HP Support

before you call 119

## I

individual speed dial

entries 87

ink cartridges. *see* print cartridges

Instant Share. *see* HP Instant Share

Internet, fax using 95, 140

iron-on transfers

copy 43

load 31

ISDN line, set up 56

## J

jams, paper 32, 125, 141

## K

keypad 6, 85

- L**
- labels
    - load 31
    - specifications 159
  - left arrow 6
  - legal paper
    - copy 35
    - load 27
    - specifications 159
  - letter paper
    - copy 36
    - load 27
    - specifications 159
  - lid backing, clean 107
  - lighten
    - copies 42
    - faxes 90
  - line condition test, fax 132
  - load
    - 10 by 15 cm photo paper 29
    - 4 by 6 inch photo paper 29
    - A4 paper 27
    - envelopes 30
    - full-size paper 27
    - greeting cards 31
    - Hagaki cards 30
    - iron-on transfers 31
    - labels 31
    - legal paper 27
    - letter paper 27
    - original 25
    - postcards 30
    - transparencies 31
- M**
- maintenance
    - align print cartridges 114
    - clean exterior 107
    - clean glass 105
    - clean lid backing 107
    - clean print cartridges 115
    - prompt delay time 118
    - replace print cartridges 109
    - restore factory defaults 118
    - self-test report 108
    - set scroll speed 118
  - make copies
    - HP Director (Windows) 10
    - OS 9 HP Image Zone (Macintosh) 13
    - OS X HP Image Zone (Macintosh) 11
    - troubleshoot 144
  - manual
    - fax reports 87
    - receive, fax 83
    - send, fax 80, 82
    - troubleshoot, fax 136
  - media. *see* paper
  - memory
    - delete faxes 95
    - reprint faxes 95
    - save faxes 93
  - modem. *see* PC modem
  - monitor dialing 82
  - more applications (OS 9 HP Image Zone) 14
- N**
- normal copy quality 37
  - number of copies
- O**
- OK button 6
  - on button 7
  - one-touch speed dial buttons 6
  - order
    - paper 103
    - print cartridges 103
    - Setup Guide 103
    - software 103
    - User Guide 103
- P**
- paper
    - incompatible types 26
    - jams 32, 125, 141
    - legal to letter copy 41
    - load 27
    - order 103
    - paper sizes 159
    - recommended copy types 36
    - recommended types 26
    - size, set for fax 90
    - troubleshoot 141
  - paper size
    - copy setting 35
  - paper specifications 159
  - paper-tray capacities 159
  - parallel phone systems 52
  - PBX system, set up 56
  - PC modem
    - set up with fax 61, 62, 67
    - troubleshoot 134, 137
  - phone
    - receive fax 83
    - send fax 80
  - phone cord
    - check 132
    - connection, failure 132
    - extend 140
  - phone numbers, customer support 147
  - photo paper
    - copy 36
    - load 29
    - specifications 159
  - photos
    - enhance copies 43
    - HP Image Zone 99
    - photo print cartridge 112
    - send scanned images 98
  - physical specifications 162
  - poll to receive fax 84
  - postcards, load 30
  - power specifications 162
  - print
    - cancel job 49
    - fax reports 74, 80, 86, 87
    - faxes 95
    - from computer 47
    - from software application 47
    - print options 48
    - print specifications 160
    - self-test report 108
  - print cartridge protector 113
  - print cartridges
    - align 114
    - clean 115
    - clean contacts 115
    - clean ink nozzle area 116
    - handle 109
    - order 103
    - part names 109
    - photo print cartridge 112
    - replace 109
    - store 113
    - troubleshoot 123, 143
  - print margin specifications 160
  - printer sharing
    - Macintosh 18
    - Windows 17, 18
  - prompt delay time 118

pulse dial 91

## Q

quality button 7  
quality, copy 37

## R

readme file, view 120  
receive faxes  
    forwarding 91  
    manually 83  
    polling 84  
recycling 163  
redial fax 81, 92  
redial/pause 7  
reduce faxes to fit 93  
reduce/enlarge 7  
reduce/enlarge copies  
    custom size 41  
    resize to fit letter 41  
    resize to fit letter or A4 40  
regulatory notices  
    Canadian statement 165  
    declaration of conformity  
    (European Economic  
    Area) 167  
    declaration of conformity  
    (U.S.) 168  
    FCC requirements 164  
    FCC statement 164  
    notice to users in  
    Japan 166  
    notice to users in  
    Korea 167  
    notice to users in the  
    European Economic  
    Area 166  
    notice to users of the  
    German telephone  
    network 166  
    regulatory model  
    identification number 163  
reinstall software 128  
replace print cartridges 109  
reports  
    confirmation 86  
    error 86  
    fax 74, 80, 86, 87, 130  
    fax log 87  
    fax test failed 131  
    last fax transaction 87  
    self-test 87, 108  
    speed dial list 87

reprint faxes in memory 95  
resolution, fax 89  
restore factory settings 118  
return your HP All-in-One 155  
right arrow 6  
ring, answer pattern 92  
rings to answer fax 83

## S

save, faxes in memory 93  
scan  
    from front panel 45  
    HP Instant Share 98  
    scan specifications 162  
    stop 46  
scan document  
    HP Director (Windows) 10  
    OS 9 HP Image Zone  
    (Macintosh) 13  
    troubleshoot 144  
scan glass  
    clean 105  
    load original 25  
scan picture  
    HP Director (Windows) 9  
    OS 9 HP Image Zone  
    (Macintosh) 13  
    OS X HP Image Zone  
    (Macintosh) 11  
    troubleshoot 144  
scan to  
    menu (USB - Macintosh) 8  
    menu (USB - Windows) 8  
    menu button 7  
scan to OCR (OS X HP Image  
Zone) 11  
schedule, fax 81  
scroll speed 118  
self-test report 87, 108  
send fax  
    basic fax 79  
    manual 80, 82, 136  
    memory, from 82  
    monitor dialing 82  
    redial 81  
    schedule 81  
    speed dials 81  
    troubleshoot 144  
send to a device  
    HP Director  
    (Macintosh) 101  
    HP Image Zone  
    (Macintosh) 100  
    HP Image Zone  
    (Windows) 99  
    scanned images 98  
serial number 147  
serial phone system 52  
service ID 147  
settings  
    auto answer 77  
    date and time 84  
    fax 90  
    print options 48  
    speed, fax 94  
setup  
    answering machine 65, 67  
    distinctive ringing 57, 92  
    DSL line 56  
    fax 51  
    ISDN line 56  
    menu 8  
    menu button 6  
    PBX system 56  
    PC modem 61, 62, 67, 71  
    separate fax line 55  
    shared phone line 58  
    test fax 74, 130  
    troubleshoot fax 130  
    voice mail 60, 71  
ship your HP all-in-one 152  
software  
    reinstall 128  
    troubleshoot  
    installation 126  
    uninstall 128  
software application, print  
from 47  
software update.. see device  
update  
sounds, adjust fax 91  
specifications. see technical  
information  
speed  
    copy 37  
    front panel scroll 118  
speed dial button 6  
speed dialing  
    create entries 87, 88  
    delete settings 89  
    edit 88  
    groups 88  
    print list 87  
    send fax 81  
start copy  
    black 7

## Index

- color 7
  - start fax
    - black button 6
    - color button 6
  - start scan button 7
  - stop
    - copy 44
    - fax 92, 96
    - print job 49
    - scan 46
    - scheduled fax 82
  - subscriber identification code 85
  - support
    - before you call 119
    - resources 119
  - symbols, enter 85
  - system requirements 159
- T**
- technical information
    - copy specifications 161
    - environmental specifications 162
    - fax specifications 161
    - paper sizes 159
    - paper specifications 159
    - paper-tray capacities 159
    - physical specifications 162
    - power specifications 162
    - print margin specifications 160
    - print specifications 160
    - scan specifications 162
    - system requirements 159
    - weight 162
  - telephone
    - receive fax 83
    - send fax 80
  - telephone answering machine.  
see answering machine
  - telephone numbers, customer support 147
  - telephone wall jack, fax 131
  - test
    - dial tone 133
    - fax hardware test 131
    - fax line condition 132
    - fax port 132
    - fax setup 74, 130
    - fax test failed 131
    - phone cord 132
    - telephone wall jack 131
  - text
    - enhance on copies 42
    - enter on keypad 85
  - time, set 84
  - tone dial 91
  - transparencies
    - copy 36
    - load 31
    - specifications 159
  - troubleshoot
    - about 119
    - blocked carriage 125
    - contact HP Support 119
    - fax
      - problems 134, 136, 139, 140
      - 140
      - fax test 131
    - hardware installation 120
    - incorrect measurements 122
    - installation overview 120
    - jams, paper 32, 125
    - language, display 122
    - operational tasks 141
    - paper 141
    - print cartridges 123, 143
    - receiving faxes 134, 137
    - sending faxes 134, 136
    - software installation 126
    - static on phone line 139
    - support resources 119
    - USB cable 121
  - two-wire phone cord 134, 140
- U**
- uninstall
    - software 128
  - USB cable installation 121
- V**
- voice mail
    - set up with fax 60, 71, 77
    - troubleshoot 137
  - volume, adjust fax 91
- W**
- wall jack test, fax 131
  - warranty
    - duration 155
    - service 155
    - statement 156
    - upgrades 155
  - Webscan 20





i n v e n t



Printed on at least 50% total recycled fiber  
with at least 10% post-consumer paper

© 2004 Hewlett-Packard Development Company, L.P.

Electronic Edition

[www.hp.com](http://www.hp.com)



Q5800-90130