

# INSTALLATION GUIDE

## AXIS M3025-VE Network Camera

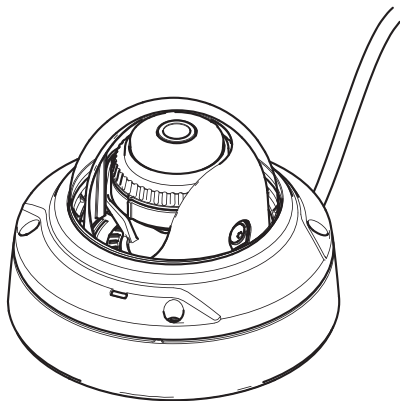

## About this Document

This document includes instructions for installing AXIS M3025-VE on your network. Previous experience of networking will be beneficial when installing the product.

## Legal Considerations

Video and audio surveillance can be prohibited by laws that vary from country to country. Check the laws in your local region before using this product for surveillance purposes. This product includes one (1) H.264 decoder license. To purchase further licenses, contact your reseller.

## Trademark Acknowledgments

AXIS COMMUNICATIONS, AXIS, ETRAX, ARTPEC and VAPIX are registered trademarks or trademark applications of Axis AB in various jurisdictions. All other company names and products are trademarks or registered trademarks of their respective companies.

Apple, Boa, Apache, Bonjour, Ethernet, Internet Explorer, Linux, Microsoft, Mozilla, Real, SMPTE, QuickTime, UNIX, Windows, Windows Vista and WWW are registered trademarks of the respective holders. Java and all Java-based trademarks and logos are trademarks or registered trademarks of Oracle and/or its affiliates. UPnP™ is a certification mark of the UPnP™ Implementers Corporation.

SD, SDHC and SDXC are trademarks or registered trademarks of SD-3C, LLC in the United States, other countries or both. Also, miniSD, microSD, miniSDHC, microSDHC, microSDXC are all trademarks or registered trademarks of SD-3C, LLC in the United States, other countries or both. WPA, WPA2 and Wi-Fi Protected Setup are marks of the Wi-Fi Alliance.

Microsoft, Windows, Windows Vista, WWW, Internet Explorer, DirectX, Intel, Intel Core, Pentium and Xeon are registered trademarks of the respective holders.

Acrobat, Adobe, Apache, Debian, Ethernet, Internet Explorer, Iomega, LaCie, Linux, Machintosh, Microsoft, Mozilla, MySQL, Red Hat, UNIX, Windows, WWW, Wi-Fi are registered trademarks of the respective holders. Java and all Java-based trademarks and logos are trademarks or registered trademarks of Oracle and/or its affiliates. UPnP™ is a certification mark of the UPnP™ Implementers Corporation. WPA is a mark of the Wi-Fi Alliance.

## Electromagnetic Compatibility (EMC)

This equipment has been designed and tested to fulfill applicable standards for:

- Radio frequency emission when installed according to the instructions and used in its intended environment.
- Immunity to electrical and electromagnetic phenomena when installed according to the instructions and used in its intended environment.

**USA** – This equipment has been tested using a shielded network cable (STP) and found to comply with the limits for a Class B digital device, pursuant to part 15 of the FCC Rules. These limits are designed to provide reasonable protection against harmful interference in a residential installation. This equipment generates, uses and can radiate radio frequency energy and, if not installed and used in accordance with the instructions, may

cause harmful interference to radio communications. However, there is no guarantee that interference will not occur in a particular installation. If this equipment does cause harmful interference to radio or television reception, which can be determined by turning the equipment off and on, the user is encouraged to try to correct the interference by one or more of the following measures:

- Reorient or relocate the receiving antenna.
- Increase the separation between the equipment and receiver.
- Connect the equipment into an outlet on a circuit different from that to which the receiver is connected.
- Consult the dealer or an experienced radio/TV technician for help.

**Canada** – This Class B digital apparatus complies with Canadian ICES-003.

**Europe** –  This digital equipment fulfills the requirements for RF emission according to the Class B limit of EN 55022.

This product fulfills the requirements for immunity according to EN 61000-6-1 residential, commercial and light-industrial environments.

This product fulfills the requirements for immunity according to EN 61000-6-2 industrial environments.

This product fulfills the requirements for immunity according to EN 55024 residential and commercial environments.

#### **Australia**

This digital equipment fulfills the requirements for RF emission according to the Class B limit of AS/

#### **NZS CISPR 22.**

**Korea** – 이 기기는 가정용(B급) 전자파적합기기로서 주로 가정에서 사용하는 것을 목적으로 하며, 모든 지역에서 사용할 수 있습니다.

**Japan** – この装置は、クラスB 情報技術装置です。この装置は、家庭環境で使用することを目的としています。この装置がラジオやテレビジョン受信に近接して使用されると、受信障害を引き起こすことがあります。取扱説明書に従って正しい取り扱いをして下さい。

#### **Safety**

This product complies with IEC/EN/UL 60950-22, Safety of Information Technology Equipment.

The power supply used with this product shall fulfill the requirements for Safety Extra Low Voltage (SELV) and Limited Power Source (LPS) according to IEC/EN/UL 60950-22.

The product's network cable shall be routed in such a way that it is not exposed to wet conditions.

#### **Equipment Modifications**

This equipment must be installed and used in strict accordance with the instructions given in the user documentation. This equipment contains no user-serviceable components. Unauthorized equipment changes or modifications will invalidate all applicable regulatory certifications and approvals.

#### **Liability**

Every care has been taken in the preparation of this document. Please inform your local Axis office of any inaccuracies or omissions. Axis Communications AB cannot be held responsible for any technical or typographical errors and reserves the right to make changes to the product and documentation without prior notice. Axis Communications AB

makes no warranty of any kind with regard to the material contained within this document, including, but not limited to, the implied warranties of merchantability and fitness for a particular purpose. Axis Communications AB shall not be liable nor responsible for incidental or consequential damages in connection with the furnishing, performance or use of this material. This product is only to be used for its intended purpose.

### Disposal and Recycling

When this product has reached the end of its useful life, dispose of it according to local laws and regulations. For information about your nearest designated collection point, contact your local authority responsible for waste disposal. In accordance with local legislation, penalties may be applicable for incorrect disposal of this waste.

#### Europe

This symbol means that the product shall not be disposed of together with household or commercial waste.



Directive 2012/19/EU on waste electrical and electronic equipment (WEEE) is applicable in the European Union member states. To prevent potential harm to human health and the environment, the product must be disposed of in an approved and environmentally safe recycling process. For information about your nearest designated collection point, contact your local authority responsible for waste disposal. Businesses should contact the product supplier for information about how to dispose of this product

correctly.

This product complies with the requirements of Directive 2011/65/EU on the restriction of the use of certain hazardous substances in electrical and electronic equipment (RoHS).

#### China

This product complies with the requirements of the legislative act Administration on the Control of Pollution Caused by Electronic Information Products (ACPEIP).



### Support

Should you require any technical assistance, please contact your Axis reseller. If your questions cannot be answered immediately, your reseller will forward your queries through the appropriate channels to ensure a rapid response. If you are connected to the Internet, you can:

- download user documentation and firmware updates
- find answers to resolved problems in the FAQ database. Search by product, category, or phrases
- report problems to Axis support by logging in to your private support area.

### Battery Replacement

This Axis product uses a 3.0 V CR2032 lithium battery as the power supply for its internal real-time clock (RTC). Under normal conditions this battery will last for a minimum of 5 years. Low battery power affects the operation of the RTC, causing it to reset at every power-up. A log message will appear when the battery needs replacing. The battery should not be replaced unless required!

If the battery does need replacing,

please contact [www.axis.com/techsup](http://www.axis.com/techsup) for assistance.

#### Contact Information

Axis Communications AB  
Emdalavägen 14  
223 69 Lund  
Sweden  
Tel: +46 46 272 18 00  
Fax: +46 46 13 61 30  
[www.axis.com](http://www.axis.com)

#### **⚠ WARNING**

- Dispose of used batteries according to the manufacturer's instructions.

#### **NOTICE**

- Risk of explosion if battery is incorrectly replaced.
- Replace only with the same or equivalent battery, as recommended by the manufacturer.

#### Dome Cover Cleaning

#### **NOTICE**

- Be careful not to scratch or damage the dome cover. Do not clean a dome cover that looks clean to the eye and never polish the surface. Excessive cleaning could damage the surface.
- For general cleaning of a dome cover it is recommended to use a non-abrasive, solvent-free neutral soap or detergent with water and a soft cloth. Rinse well with clean lukewarm water. Dry with a soft cloth to prevent water spotting.
- Never use harsh detergents, gasoline, benzene or acetone etc. and avoid cleaning in direct sunlight or at elevated temperatures.

#### Warranty





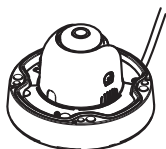

1x

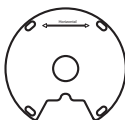

1x



1x



1x



1x



1x



1x



2x



1x



1x



1x



1x

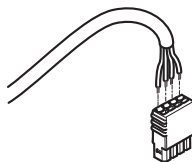
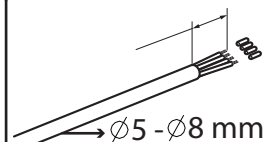

1

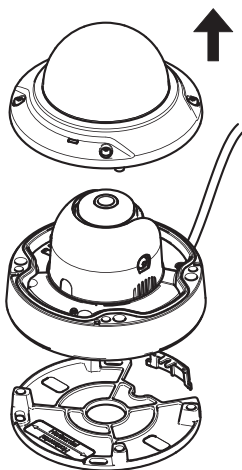

2

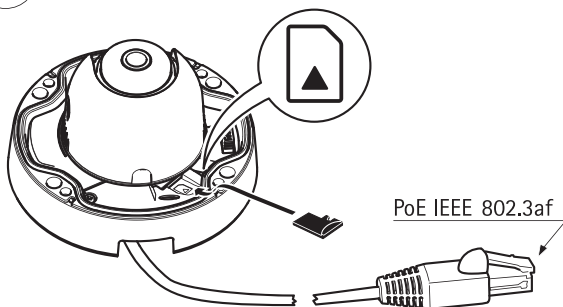



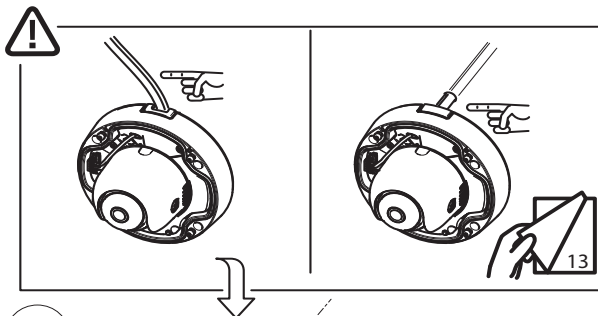
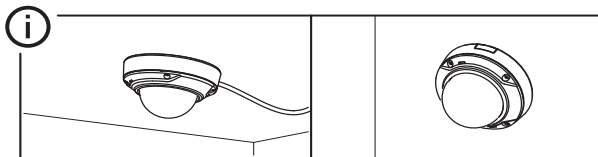

3

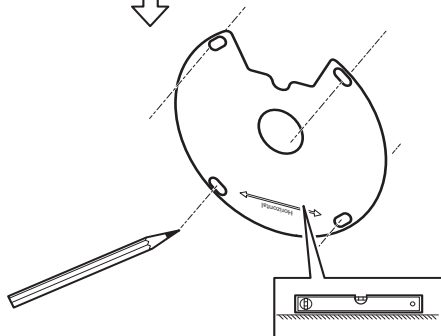

4

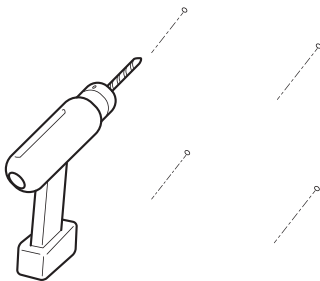

5

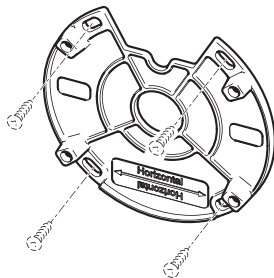

6

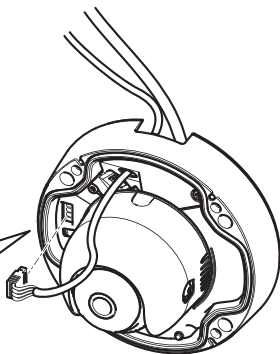
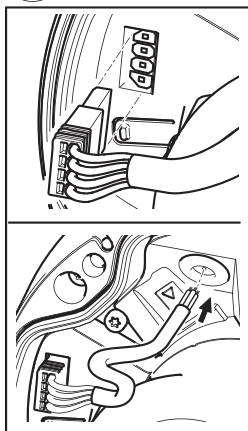

7

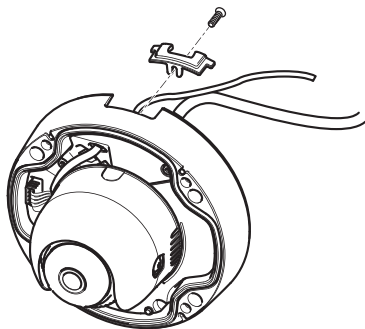

8

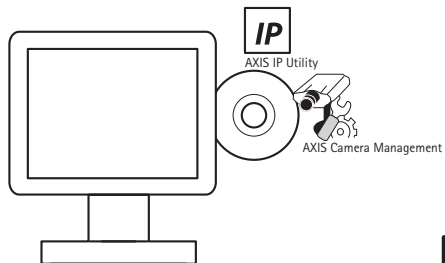
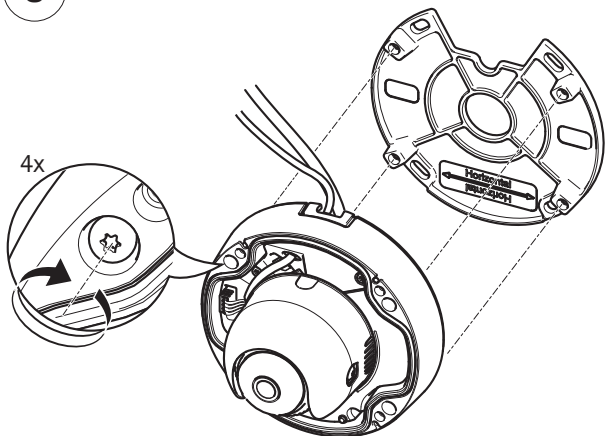

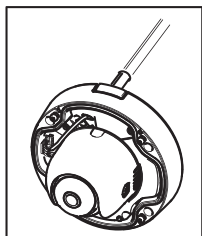

9

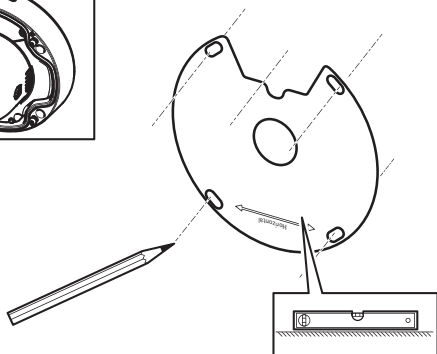

10

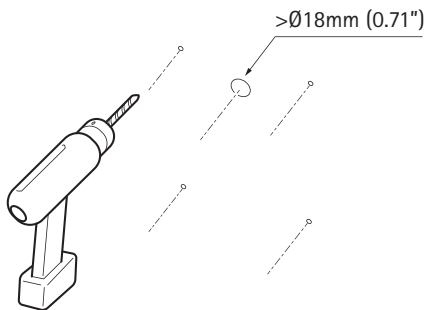

11

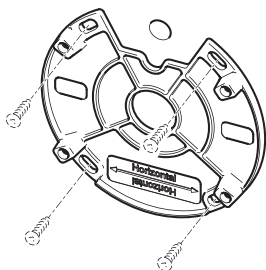

12

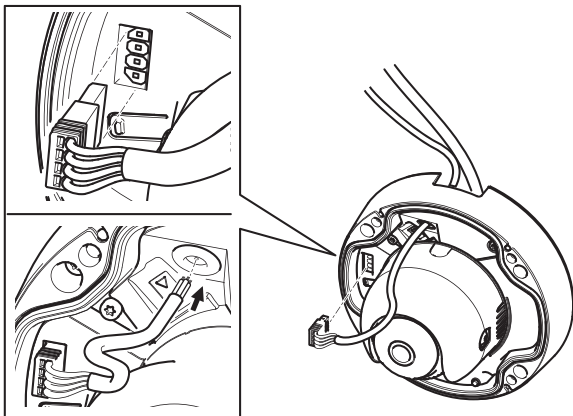

13

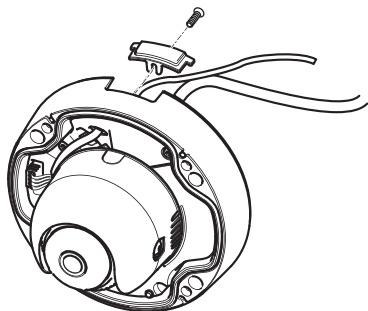

14

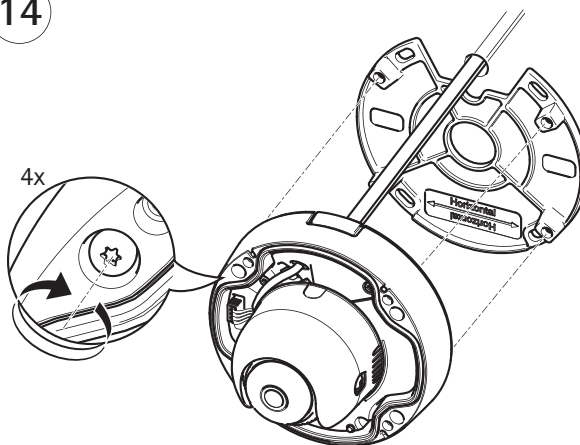

15

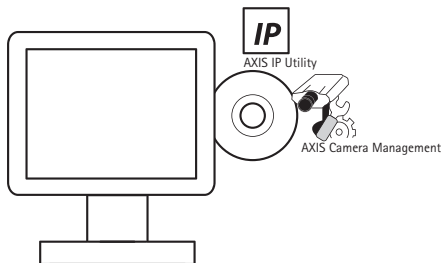



16

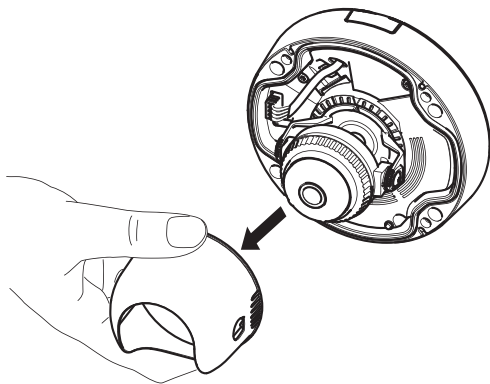
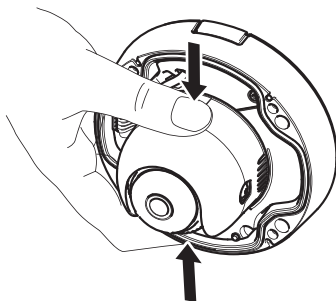

17

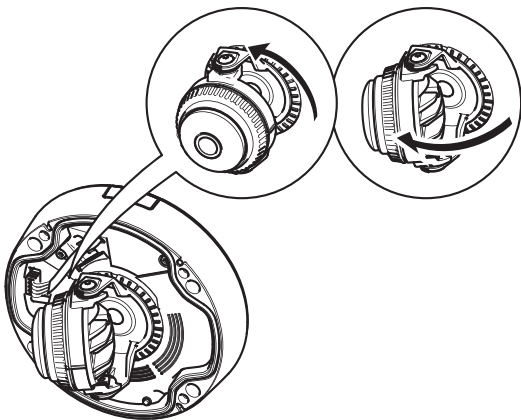
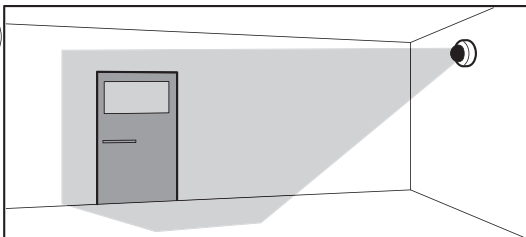

18

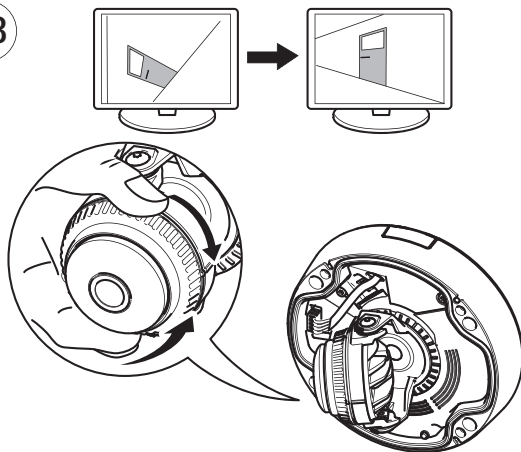

19

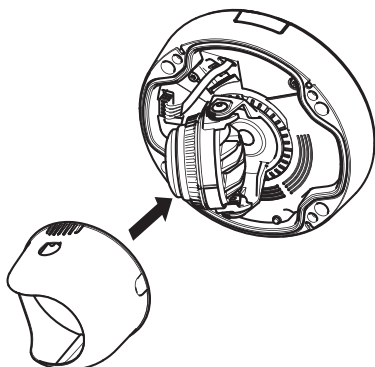

20

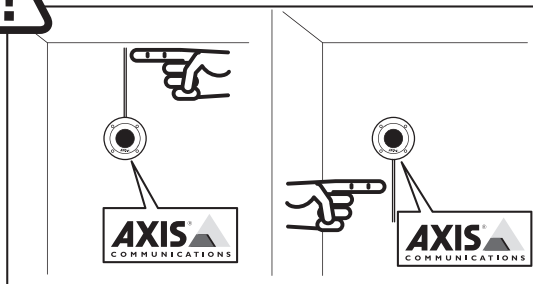
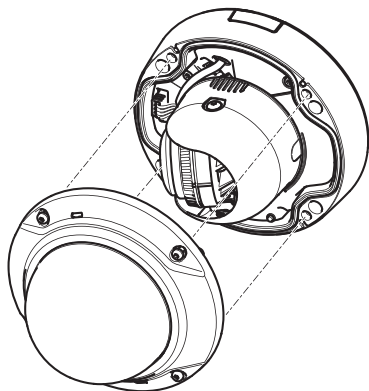



Installation Guide

AXIS M3025-VE Network Camera

© Axis Communications AB, 2013

Ver.2.0

Printed: August 2013

Part No. 52582